

• REGÁLOVÉ PREZENTÁCIE



EXKLUZÍVNE ZNAČKY

STREND PRO®

STREND PRO®
PREMIUM

STREND PRO®
GARDEN



Magie HOME

CLEONIX

whirlpower

WORCRAFT
PROFESSIONAL

AQUACRAFT

ZASTÚPENIE PRE SLOVENSKO



Dielňa / Workshop

Náradie Whirlpower / Tools Whirlpower	3-5
Kliešte, hasáky / Pliers	6-8
Nožnice, píly / Scissors, saws	9
Sponkovačky / Staplers	10
Nitovacie kliešte / Riveters	11
Sady kľúčov a kľúče / Sets of spanners and spanners	12-13
Profesionálne náradie / Professional tools	14-19
Sady náradia / Set of tools	20
Inbusový kľúče / Hexagonal keys	21
Sady náradia / Tool sets	22
Sady skrutkovačov / Set of screwdrivers	23-24
Skrutkovače / Screwdrivers	25
Sady bitov a naradia / Bit sets and tools	26-28
Nože / knives	29-30
Brašne, puzdra a organizéry / Tool bags and organizers	31-32
Boxy na náradie a organizéry / Tool boxes and organizers	33-34
Kladivá a palice / Hammers and mallets	35-36
Pilníky / Files	37
Brusné papiere / Sanding paper	38
Brušivo / Abrasive	39
Vrtáky / Drills	40-41
Sady vrtákov a závitníkov / Sets of drills and screw-cutters	42-43
Obrábanie dreva a kovu / Working wood and metal	44
Vykružovače a unášače / Holesaws	45
Zvierky, držiaky a zveráky / Clamps and bench vices	46-47
Zdvíhaky, pumpy, autolopatky a autoplachty / Hydraulic jacks, pumps and shovels	48-49
Rukavice / Gloves	50-52
Ochranné pomôcky / Protective equipment	53-56
Oceľové kefy / Wire brushes	57-58
Brusné a rezné kotúče / Discs	59-60
Príslušenstvo / Accesories	61
Plynový program / Gas accessories	62
Zvárací a spájovací materiál / Welding material	63
Turistika / Outdoor camping	64-65
Plyn / Gas accessories	66
Výrobný program Pilana / Tools Pilana	67-68
Pílové kotúče / Discs	69

Stavba / Construction

Náradie Kapro / Tools Kapro	70-72
Laty, vodováhy / Levels	73
Metre / Meters	74-75
Hladítka/ Bricklaying trowel	76-78
Škrabáky a mriežky / Scrapers	79
Rašple / Rasp	80
Stierky / Spatulas	81-82
Lyžice, naberačky / Spoons, scoops	83
Murárske príslušenstvo / Accessories for building	84-85
Systém nivelizácie podláh / Leveling	86
Sekáče a vysekávače / Chisels and punches	87-88
Rezačky / Cutter tile	89-90
Píly na pôrobeton a výtlačné pištole / Saws and caulking gun	91-92
Murárske príslušenstvo / Accessories for building	93
Miešadla / Mixers	94
Závesy petlice a drôty / Joints and wires	95-96
Klince, skrutky, vrúty... / Nails and screws	97-98
Uholníky a podpery / Joints	99
Ventilácia/ Ventilation	100
Zámky, vložky, kľúče, zatvárače a trezory / Door locks and safes	101-104
Sady maliarské, mriežky a valčeky / Painting sets and rollers	105-107
Štetce, štetky a sady štetcov / Paint brushes, brushes and set of painting brushes	108-109
Pásky / Tapes	110

Elektro / Electro

El. náradie Worcraft / Power tools Worcraft	111-120
Vysávače / Vacuums	121
Elektronáradie / Power tools	122-123
Spájkovanie / Soldering	124
Teplovzdušné pištole / Hot air guns	125
Autonabíjačky / Car chargers	126
Nabíjanie a štartovanie / Charging and startups	127
Kompresory / Air compressors	128
Pneumatické príslušenstvo / Pneumatic accesories	129-130
Miešadlá / Mixers	131
Miešačky / Electric mixers	132
Svietidlá / Lights	133-134
Ventilátory / Fans	135
Ohrievače / Heaters	136-137
Káble/ Cables	138

Záhradná technika / Garden power machinery

Kosačky / Lawn mower	140-141
Krovinorezy a vyžinače / Brushcutters and trimmers	142
Rotavátory a zemný vrták / Tillers and earth auger	143
Plotostrihy a nožnice / Hedge trimmers and scissors	144
Štiepačky a píly / Log splitter and chainsaws	145-146
Drviče a rosiče/ Shredders and knapsack sprayers	147
Čerpadlá / Water pumps	148-150
Vysokotlakové čističe a elektrocentrály / High pressure cleaners and generators	151

Záhrada / Garden

Píly / Garden saws	154-156
Sekery / Axes	157-159
Nožnice / Garden scissors	160-166
Kvetináče, podložky / Flower pots	167-171
Príslušenstvo k sadeniu / Accessories at planting	172-173
Pareniská a sadbovače / Greenhouse and seedling tray	174
Príslušenstvo k sadeniu / Accessories at planting	175-177
Sílony, obruby, tkaniny, palisady a oplotenie / Palisades and fences	178-179
Pletivá a drôty / Fences and wires	180-181
Postrekovače / Sprayers	182-187
Umyvadla a pumpy/ Wash basins and pumps	188
Hadice a navijáky / Hose reel	189-191
Striekacie pištole / Water pistols	192-193
Zavlažovací program / Watering tools	194-197
Spojky a adaptéry / Adapters	198-200
Náradie pre záhradkárov / Garden tools	201-205
Násady / Handles	206
Motyky / Hoes	207-208
Ryle / Spades	209
Kosy a oslíčky / Scythes	210
Vidly a kosáky/ Forks	211
Lopaty a ryle / Shovels and spades	212
Hrable/ Rakes	213-215
Lopaty na sneh a škrabky/ Snow shovels and scrapers	216-217
Fúriky a vozíky / Wheels barrows and wheels	218-219
Mlynčeky, lisy, rezačky / Cutters, Presses	220-221
Kŕmitka, napájačky / Feeders	222-223
PVC Barelly, nádoby, prepravky / PVC barrels, Containers	224-225
Solárne lampy / Solar lamps	226-227

Voľný čas / Leisure

Grily a krbové podpaľače / Grills and fireplace lighters	228-229
Grilovacie náradie / Grill sets	230-231
Záhradné sety, stoly, lavice a stany / Garden sets, tables, benches and tents	232
Terasové sety / Terrace sets	233
Stoly, lavičky a stany / Tables, benches and tents	234
Záhradný drevený nábytok / Garden wooden furniture	235
Stoličky / Chairs 236	236
Lehátka a stany / Folding beds and tents	237
Slničníky a stojany / Umbrellas and stands	238-239
Hojdacie siete, hojdačky a lavičky / Nets, Swings and benches	240-243

Domácnosť / Household

Kachle, sporáky, vložky zásteny/ Fireplaces	246-247
Krbové náradie a sviečky / Fireplaces accessories and candles	248-249
Dymovina / Chimney accessories	250-253
Paráky, kotlíky a nádoby / Buckets watering, goulash pot	254-255
Kanistre a vedrá / canisters, buckets	256-257
Mopy, stierky a prachovky / Mops, Spatulas and Dusters	258-260
Metly, smetníčky / Brooms	261-263
Handry, hubky / Dish cloths	264
Kefy / Brushes	265
Sušiaci, koše a prachovky / Dryers, Baskets, Dusters	266-267
Koše a nádoby na odpad / Baskets, Containers	268-269
Doplnky do kuchyne / Kitchen accesories	270
Rohožky / Mats	271-273
Lampáže / Oil lamps	274
Laná, motúzy / Ropes, strings	275
Teplomery / Thermometers	276
Schránky / Post boxes	277
Popruhy / Straps	278-279
Vozíky / Wheels	280-281
Rebríky, plošiny, schodky a regále / Ladders, platforms, stairs and regals	282-285
Nákupné vozíky / Shopping trolley bag	286
Pasce, siete proti hmyzu / Traps, mosquitos nets	287
Bazény a príslušenstvo / Swimming pools and accessories	288-295
Regálový systém / Racks	296

Sada pilníkov

227561
5 dielna
200mm



Pilníky

227542 (A) 150mm, plochý
227343 (A) 200mm, plochý
227308 (B) 200mm, polkruh
227352 (B) 200mm, polkruh
227178 (C) 150mm, okrúhly
227191 (D) 200mm, trojhranný
227282 (E) 150mm, štvorhranný
227264 (E) 200mm, štvorhranný

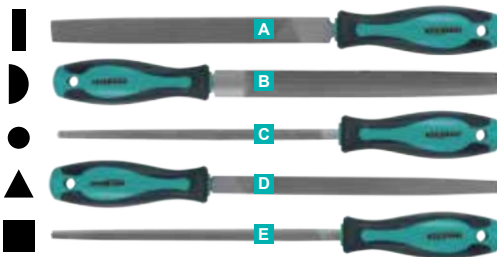

Maznica olejová, ručná

235008 400cc / 310 bar.

Maznica olejová sa používa v poľnohospodárstve, v priemysle. Je ľahko ovládateľná. Max. pracovný tlak: 310 bar.



Rezač trubiek

222916 4-32 mm
52.5x130 mm



Kliešte na poistné krúžky

229862 A)165mm / vnútorné, rovné
229860 A)180mm / vonkajšie, rovné



- 55° a 90° nastaviteľné uhly
- ABS + PP plastová rukoväť
- 24 zubov na palec

Pílka na kov, ABS/PP

226187 400 mm / 55°/90°



Kliešte na poistné krúžky

229863 B)170mm / vnútorné, zahnuté
229861 B)180mm / vonkajšie, zahnuté



Nitovacie kliešte

229865 260mm
2.4 - 4.8mm



Nitovacie kliešte s otočnou hlavou

229917 280mm
2.4-3.2-4.0-4.8mm



Sekáč špicatý, gumený chránič

233455 05x150 mm



Sekáč plochý, gumený chránič

233452 10x150 mm
233172 12x150 mm
233453 15x180 mm
233454 19x200 mm
233245 22x200 mm



Kliešte kombinované

229849 160mm, DIN5746
229850 180mm, DIN5746
229851 200mm, DIN5746



Nožnice na plech

229864 250mm / pravé



Nožnice na plech

229274 250mm / ľavé



Nožnice na plech

229916 250mm / rovné



Kliešte s plochým nosom

229852 160mm, DIN5745



Kliešte s okrúhlym nosom

229855 160mm, DIN5745



Kliešte vyhnuté

229856 160mm, DIN5745



Kliešte s dlhým nosom

229853 160mm, DIN5745
229854 200mm, DIN5745



Kliešte štikacie / VDE1000

229915 200mm, DIN5749



Kliešte štikacie / VDE1000

229847 160mm, DIN5749



Kliešte štikacie

232397 125mm, DIN5745
229858 160mm, DIN5745



Kliešte odblankovacie, 6mm

229859 180mm, DIN5745



VDE1000 Kliešte s dlhým nosom

229845 200mm, DIN5745



VDE1000 Kliešte vyhnuté

229846 200mm, DIN5745



VDE1000 Kliešte odblankovacie

229848 180mm / 6mm



VDE1000 Kliešte kombinované

229500 180mm, DIN5746
229057 200mm, DIN5746



Skrutkovač plochý / S2 / DIN5264

- 2250311 (A) 3.0 / 100mm
- 2250312 (A) 4.0 / 100mm
- 2250313 (A) 5.5 / 100mm
- 2250314 (A) 6.5 / 100mm
- 2250315 (A) 8.0 / 150mm
- 2250316 (A) 5.5 / 125mm Hexbolt
- 2250317 (A) 6.5 / 125mm Hexbolt
- 2250318 (A) 8.0 / 150mm Hexbolt

Rukoväť
 • Ergonomická rukoväť pre lepší úchop počas dlhodobej práce.
 • Šesťstranná rukoväť bráni odkotúľaniu.

Telo
 • Kvalitný materiál Křemiková oceľ (S2)
 • Presne tvarovaný tvar zapadne do skrutky.
 • Fosfatová povrchová úprava bráni korózii.
 • Magnetický povrch



Skrutkovač plochý / DIN5264 s kovovým úderníkom / S2

- 2250348 (B) 5.5 / 100mm Hexbolt
- 2250349 (B) 6.5 / 125mm Hexbolt
- 2250350 (B) 10.0 / 200mm Hexbolt

Kľúč imbusový

- 2310571 A) TX06
- 2310572 A) TX07
- 2310573 A) TX08
- 2310574 A) TX09
- 2310575 A) TX10
- 2310576 A) TX15
- 2310577 A) TX20

- 2310578 B) 1.5mm
- 2310579 B) 2.0mm
- 2310580 B) 2.5mm
- 2310581 B) 3.0mm
- 2310582 B) 4.0mm
- 2310583 B) 5.0mm
- 2310584 B) 6.0mm
- 2310586 B) 7.0mm
- 2310587 B) 8.0mm
- 2310588 B) 10 mm
- 2310589 B) 12 mm
- 2310590 B) 14 mm
- 2310591 B) 17 mm
- 2310592 B) 19 mm
- 2310593 B) 21 mm
- 2310594 B) 22 mm

- 2310596 C) 1.5mm
- 2310597 C) 2.0mm
- 2310598 C) 2.5mm
- 2310599 C) 3.0mm
- 2310600 C) 4.0mm
- 2310601 C) 5.0mm
- 2310602 C) 6.0mm
- 2310603 C) 7.0mm
- 2310604 C) 8.0mm
- 2310605 C) 10 mm
- 2310606 C) 12 mm
- 2310608 C) 14 mm

- 2310585 B) 3.0mm
- 2310586 B) 4.0mm
- 2310587 B) 5.0mm
- 2310588 B) 6.0mm
- 2310589 B) 7.0mm
- 2310590 B) 8.0mm
- 2310591 B) 10 mm
- 2310592 B) 12 mm
- 2310593 B) 14 mm
- 2310594 B) 17 mm
- 2310595 B) 19 mm
- 2310596 B) 21 mm
- 2310597 B) 22 mm



Račňový očkoplochý kľúč

- 231143 08, FlexiGear, Cr-v
- 231706 09, FlexiGear, Cr-v
- 231144 10, FlexiGear, Cr-v
- 231145 11, FlexiGear, Cr-v
- 231707 12, FlexiGear, Cr-v
- 231146 13, FlexiGear, Cr-v
- 231708 14, FlexiGear, Cr-v
- 231147 15, FlexiGear, Cr-v
- 231176 16, FlexiGear, Cr-v
- 231148 17, FlexiGear, Cr-v
- 231149 18, FlexiGear, Cr-v
- 231150 19, FlexiGear, Cr-v



Sada kľúčov, vidlicová

2310663 12 dielna

6x7, 8x9, 10x11, 12x13, 14x15, 16x17, 18x19, 20x22, 21x23, 24x27, 25x28, 30x32mm



Skrutkovač krížový / S2 / DIN8764

- 2250319 (A) PH0 / 060mm
- 2250320 (A) PH1 / 080mm
- 2250321 (A) PH2 / 100mm
- 2250322 (A) PH3 / 150mm
- 2250323 (B) PH2 / 100mm Hexbolt

Rukoväť
 • Ergonomická rukoväť pre lepší úchop počas dlhodobej práce.
 • Šesťstranná rukoväť bráni odkotúľaniu.

Telo
 • Kvalitný materiál Křemiková oceľ (S2)
 • Presne tvarovaný tvar zapadne do skrutky.
 • Fosfatová povrchová úprava bráni korózii.
 • Magnetický povrch



Skrutkovač Pozi / S2 / DIN8764

- 2250324 (A) PZ0 / 060mm
- 2250325 (A) PZ1 / 080mm
- 2250326 (A) PZ2 / 100mm
- 2250327 (A) PZ3 / 150mm
- 2250328 (B) PZ2 / 100mm Hexbolt



Izolovaný skrutkovač / VDE1000

- 2250331 2.5 / 075mm
- 2250332 3.0 / 100mm
- 2250333 3.5 / 100mm
- 2250334 4.0 / 100mm
- 2250335 5.5 / 125mm
- 2250336 6.5 / 150mm
- 2250337 8.0 / 175mm
- 2250338 PH0 / 060mm
- 2250339 PH1 / 080mm
- 2250340 PH2 / 100mm
- 2250341 PH3 / 150mm
- 2250342 PZ0 / 060mm
- 2250343 PZ1 / 080mm
- 2250344 PZ2 / 100mm
- 2250345 PZ3 / 150mm

DIN3126

Skrutkovač magnetický na bity

- 2250329 1/4" / 100mm



Skrutkovač / S2 / DIN5264 / 3v1

- 2250457 PH / 100 mm



Multifunkčný skrutkovač 150 mm / 4v1

Obojstranný bit, 150mm, ⊕ 0- ⊕1, 2, 3
 1/4" zameniteľný skrutkovač



Skrutkovač / Hex / S2

- 2250458 2.0x100 mm
- 2250459 2.5x100 mm
- 2250460 3.0x100 mm
- 2250461 4.0x150 mm
- 2250462 5.0x150 mm
- 2250463 6.0x150 mm
- 2250464 8.0x200 mm
- 2250465 10x200 mm



Kľúčový skrutkovač 14 dielny

255658 1/4"

- Bity, 25mm
- ⊖ 5.5, 6.5
- ⊕ 1, 2
- ⊕ 1, 2
- ⊕ 15, 20, 25
- 4.0, 5.0, 6.0

1/4" Univerzálny skrutkovač, 60mm

Sada skrutkovačov elektrikárska

- 2250346 5 dielna + skúšačka
- 2250347 6 dielna Ergonomic

- 5 dielna: ⊖ skúšačka 3.0x63
- ⊖ 2.5x75 4x100 5.5x125
- ⊕ 1x80

- 6 dielna: ⊖ 2.5x75 3.5x100 4.0x100 5.5x125
- ⊕ 1x80 2x100



Sada skrutkovačov

2250330 6 dielna

- ⊖ 3.0x75 4.0x100 6.5x125 8.0x150
- ⊕ 1x80 2x100



Hlavica 1/2" / Cr-V

232654	08x38 mm	
232655	09x38 mm	
232656	10x38 mm	
232657	11x38 mm	
232658	12x38 mm	
232659	13x38 mm	
232660	14x38 mm	232676 24x40 mm
232661	15x38 mm	232677 25x42 mm
232662	16x38 mm	232678 26x42 mm
232666	17x38 mm	232679 27x42 mm
232667	18x38 mm	232680 28x42 mm
232668	19x38 mm	232681 29x42 mm
232669	20x38 mm	232682 30x45 mm
232673	21x38 mm	232683 31x45 mm
232674	22x38 mm	232684 32x45 mm
232675	23x38 mm	232685 34x45 mm



Hlavica 1/2" / Cr-V / predĺžená

232727	08x77 mm	
232728	09x77 mm	
232731	10x77 mm	
232737	11x77 mm	
232740	12x77 mm	
232741	13x77 mm	
232742	14x77 mm	
232744	15x77 mm	232754 21x77 mm
232745	16x77 mm	232755 22x77 mm
232748	17x77 mm	232756 24x77 mm
232749	18x77 mm	232757 27x77 mm
232751	19x77 mm	232758 30x77 mm
232752	20x77 mm	232759 32x77 mm



Hlavica 1/2" / Cr-V / S2 / Torx

232788	27x55 mm
232789	30x55 mm
232790	40x55 mm
232791	45x55 mm
232792	50x55 mm
232793	55x55 mm
232794	60x55 mm



Hlavica 1/4" / Cr-V / predĺžená

232710	4x25 mm	
232711	5x25 mm	
232712	5.5x25 mm	
232713	6x25 mm	
232714	7x25 mm	
232715	8x25 mm	
232716	9x25 mm	232719 12x25 mm
232717	10x25 mm	232723 13x25 mm
232718	11x25 mm	232725 14x25 mm



Hlavica 1/4" / Cr-V / predĺžená

232694	04x50 mm	
232695	05x50 mm	
232696	5.5x50 mm	
232697	06x50 mm	
232699	07x50 mm	
232703	08x50 mm	
232704	09x50 mm	232707 12x50 mm
232705	10x50 mm	232708 13x50 mm
232706	11x50 mm	232709 14x50 mm



Hlavica 1/4" / Cr-V / S2 / plochá

232785	4.0x32 mm
232786	5.5x32 mm
232787	8.0x32 mm



Hlavica 3/4" / Cr-V

232807	17x50 mm	
232808	18x50 mm	
232809	19x50 mm	
232811	21x50 mm	
232810	22x50 mm	
232812	24x51 mm	
232795	27x52 mm	
232796	28x52 mm	232801 36x58 mm
232797	29x52 mm	232802 38x60 mm
232798	30x54 mm	232803 41x64 mm
232799	32x56 mm	232804 46x68 mm
232800	34x56 mm	232805 50x72 mm



232726 Sada hlavíc 1/4" / 42 dielna

1/4" Bity, 25mm
 ⊖ 4, 5, 5, 6, 5
 ⊕ 1, 2, 3
 ⊗ 1, 2, 3
 ⊗ 10, 15, 20, 25, 27, 30, 40
 ● 3, 4, 5, 6
 1/4" Hlavice, 6-Point
 3, 2, 4, 4, 5, 5, 5, 5, 6, 7, 8
 9, 10, 11, 12, 13, 14 mm
 1/4" Hex držiaky
 Adaptér, 50mm
 1/4" rača, 36 zubov
 1/4" nádstavce, 55, 150mm
 1/4" univerzálny kľb, 40mm
 kardaň, 1/4"x1/4"
 1/4" zameniteľný skrutkovač



Sada hlavíc 3/4"

232806 21 dielna

3/4" hlavice, 12-Point
 19, 21, 22, 23,
 24, 26, 27, 29,
 30, 32, 35, 36, 38, 41,
 46, 50 mm
 3/4" rača, 24 zubov
 3/4" nádstavce, 100, 200, 400mm
 3/4" Sliding T Bar, 460mm



232784 Sada hlavíc a bitov 1/4" / 56 dielna

1/4" Torx hlavice, E4, E5, E6, E7, E8, E10
 1/4" hlavice, 6-Point
 4, 5, 6, 7, 8, 9, 10, 11, 12, 13mm
 3Way rača
 1/4" Adaptér, 25 mm
 140-430mm Pick Tool
 1/4" magnetický držiak, 62 mm
 1/4" flexibilný držiak, 190 mm
 Bity, 25 mm
 ⊖ 4, 0, 4, 5, 5, 5, 6, 5, 8, 0
 ⊕ 1, 2x4, 3
 ⊗ 1, 2x3, 3
 ● 10, 15, 20, 25, 27, 30, 40
 ● 10, 15, 20, 25, 27, 30, 40
 ● 3, 0, 4, 0, 5, 0, 6, 0, 8, 0



Rača s páčkou 3/4" / DIN3122

239578 24T, Cr-v, 500x62 mm



Vrátidlo 1/4"DIN3122

239588 115 mm



Vrátidlo 3/4"DIN3122

239585 460 mm



DIN3122

Rača s páčkou

239498	3/8" 72T, Cr-v
239499	1/2" 72T, Cr-v
239096	1/4" 36T, Cr-v



Rača s páčkou

239584	1/4"
	108 mm
	36T, Cr-v



DIN3123

Nástavec 1/4"

239586	075 mm
239587	100 mm

Kľb 1/4"

239589	40 mm
--------	-------



Sada hlavíc

232822 6 dielna
 1/4" + 3/8" + 1/2" + 3/4"



Sada hlavíc

232691 15 dielna,
 1/2", CrMo
 10,11,12,13,14,15,16,17,19,
 21,22,24,27,30,32 mm



Vymeniteľná sada bitov

2310662 7 dielna, 25 mm

Použitie: ⊕ 5x bit 1, 2x3, 3
 ⊗ 1x bit 2



Sada priebojníkov

234062 17 dielna

priebojník predĺžený
 3, 4, 5, 6, 8, 10mm
 priebojník
 2, 3, 4, 5, 6, 8mm
 priebojník kužeľový
 2, 3, 4, 5, 6mm



Hlavica magnetická

232686	A) 17 mm, 1/2"
232687	B) 19 mm, 1/2"
232688	C) 21 mm, 1/2"



Sada hlavíc

232593 10 dielna, 1/4", Hex



Sada skrutkovačov

2310536 6 dielna, Hex



Sada bitov, 25mm

2310537 102 dielna, Hex



Sada hlavíc, 1/2", 3 dielna

232594 17-19-21 mm

Kliešte kombinované



kód	popis		
229186	165 mm	12	0,280
229175	180 mm	12	0,317
229188	200 mm	12	0,367

Kliešte štikacie, bočné



kód	popis		
229170	160 mm	6	0,233
229180	180 mm	12	0,283

Kliešte štikacie, čelné



kód	popis		
229185	160 mm	12	0,230

Kliešte s dlhým nosom



kód	popis		
229326	150 mm	6	0,200

Kliešte s dlhými čeľustami



kód	popis		
229291	150 mm	6	0,200

Kliešte ohnuté



kód	popis		
229111	150 mm	6	0,180

Kliešte s okrúhlymi čeľustami



kód	popis		
229278	160 mm	6	0,200

Kliešte kombinované



kód	popis		
229657	150 mm	6	0,250
229658	180 mm	6	0,316
229659	200 mm	6	0,400

Kliešte s dlhým nosom



kód	popis		
229655	150 mm	6	0,200
229656	200 mm	6	0,250

Kliešte štikacie



kód	popis		
229660	150 mm, bočné	6	0,250
229661	180 mm, bočné	6	0,367

Kliešte na poistné krúžky



kód	popis		
229541	10-500mm; 180°-45°-90°	12	0,250

Kliešte na diery



kód	popis		
229181	180 mm, vnútorné	12	0,158

Kliešte na diery



kód	popis		
229255	180 mm, vnútorné	12	0,158

Klieštiky kombinované



kód	popis		
229741	115 mm	1	0,083

Klieštiky štikacie, bočné



kód	popis		
229744	115 mm	1	0,083

Klieštiky štikacie, čelné



kód	popis		
229745	115 mm	1	0,083

Klieštiky s dlhým nosom



kód	popis		
229742	115 mm	1	0,083

Klieštiky vyhnuté



kód	popis		
229743	115 mm	1	0,083

Kliešte na hriadele



kód	popis		
229176	180 mm, vonkajšie	12	0,158

Kliešte na hriadele



kód	popis		
229169	180 mm, vonkajšie	12	0,161

Kliešte armovacie, PH



kód	popis		
229164	200 mm	48	0,283
229116	225 mm	10	0,350
229073	250 mm	10	0,433

Kliešte armovacie, PH



kód	popis		
229306	200 mm	48	0,283
229519	225 mm	6	0,350
229520	250 mm	6	0,433

Kliešte štikacie



kód	popis		
229668	150 mm	6	0,233
229669	180 mm	6	0,250
229670	200 mm	6	0,350

Kliešte štikacie



kód	popis		
229662	150 mm	6	0,250
229663	180 mm	6	0,283
229664	200 mm	6	0,400

Kliešte multifunkčné 13v1



kód	popis		
229954	70-150 mm, šírka 105 mm	1	0,110

Kliešte samosvorné



kód	popis		
229513	250 mm	6	0,483

Kliešte nastaviteľné



kód	popis		
229788	250 mm / 10"	1	0,388
229789	300 mm / 12"	1	0,791

Kliešte na trúbky, PH



kód	popis		
229333	250 mm	10	0,433
229591	300 mm	10	0,604

Kliešte klampiarské



kód	popis		
229740	075 mm, prehýbacie	2	0,750
229755	150 mm, prehýbacie	2	1,080

Kliešte nastaviteľné



kód	popis		
229194	250 mm	5	0,480

Kliešte nastaviteľné, Cr



kód	popis		
229117	250 mm	10	0,400

Kliešte na trúbky, PH



kód	popis		
229265	250 mm	6	0,310

Nožnice pákové



kód	popis		
229717	450mm	1	
229718	610mm	1	
229653	760mm	1	
229654	910mm	1	

Nožnice pákové



kód	popis		
229250	460 mm	10	1,600
229315	610 mm	10	2,450
229276	760 mm	5	4,000
229277	910 mm	5	4,600



Kľúč nastaviteľný, Francúzky



kód	popis		
231923	200 mm	12	0,300
231924	250 mm	6	0,528
231925	300 mm	6	0,770
231926	380 mm	6	0,089

Hasák AIWO Cobra



kód	popis		
229652	1,0"	1	
229737	1,5"	1	
229714	2,0"	1	
229715	3,0"	1	

Hasák AIWO Bird



kód	popis		
229716	350mm	1	
229650	450mm	1	
229651	600mm	1	

Hasák "HEAVY" s vodiacou maticou



kód	popis		
229223	250 mm (10")	1	0,800
229224	300 mm (12")	1	0,900
229225	350 mm (14")	6	1,000

Hasák s vodiacou maticou



kód	popis		
229404	225 mm	6	0,560
229405	260 mm	6	0,720
229406	300 mm	6	0,920

Kliešte na duté nity

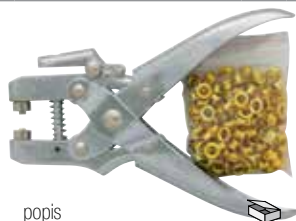

kód	popis		
229093	+ 100ks očiek	1	0,340

Hasák Hercules



kód	popis		
229130	1"	12	0,390
229112	1 1/2"	6	1,250
229110	2"	6	1,920
229245	3"	12	3,000

Kliešte odblankovacie



kód	popis		
229095	160 mm	5	0,250

Kliešte odblankovacie



kód	popis		
229544	170 mm/1.0/1.6/2.0/2.6/3.2mm	48	0,390

Kliešte "Giant" odblankovacie



kód	popis		
229248	rozsah 0.5-6 mm, 170 mm	10	0,260

Kliešte odblankovacie, Automatic



kód	popis		
229543	100 mm, rozsah 0.5-4 mm	12	0,120

Kliešte odblankovacie



kód	popis		
229981	205 mm	1	

rozsah: 10-24 AWG (0,2 - 6 mm²)
pre izolované koncovky: 10-22 AWG (0,5 - 6 mm²)
pre neizolované koncovky: 10-12 AWG (4 - 6 mm²)
pre neizolované koncovky: 14-22 AWG (0,5 - 2,5 mm²)

Kliešte štikacie



kód	popis		
229983	180 mm	1	

rozsah: 10-24 AWG (0,8 - 2,6 mm²)

Kliešte krimpovacie



kód	popis		
229984	225 mm	1	

rozsah: 10-22 AWG (0,2 - 6 mm²)
pre izolované koncovky: 10-22 AWG (0,5 - 6 mm²)
pre neizolované koncovky: 10-12 AWG (4 - 6 mm²)

Kliešte krimpovacie



kód	popis		
229542	210 mm, s lisovacími konektormi	5	0,540

Nožnice technické



kód	popis		
216851	145 mm	1	

Nožnice na strihanie káblov



kód	popis		
229777	250 mm	1	0,100

NOŽNICE A PÍLKY / SCISSORS AND SAWS

Nožnice na plech

ROSTEX



kód	popis		
229145	300 mm, na strihanie do 1,3 mm vystrihovacie	1	

Nožnice na plech

ROSTEX



kód	popis		
229146	300 mm, na strihanie do 1,3 mm vyosené	1	

Nožnice na plech

ROSTEX



kód	popis		
229016	240 mm, prevodové, pravé	1	
229147	240 mm, prevodové, ľavé	1	

Nožnice na plech

ROSTEX



kód	popis		
229483	A) 250 mm, vystrihovacie	1	0,440
229579	B) 250 mm, rovné, vystrihovacie	1	0,490

Nožnice remeselnícke

ROSTEX



kód	popis		
211455	160 mm, pre drobné práce	1	0,080

Nožnice na plech



kód	popis		
229163	300 mm, rovné, dlhé	5	0,460

Nožnice na plech



kód	popis		
229357	240 mm, rovné, krátke	5	1,330

Nožnice na plech



kód	popis		
229013	250 mm, bočné, ľavé	1	0,500
229356	250 mm, bočné, pravé, červené	1	0,500

Nožnice na plech



kód	popis		
229184	250 mm, ľavé	6	0,500

Nožnice na plech



kód	popis		
229633	12", 300 mm	36	0,850

Nožnice na plech



kód	popis		
229015	250 mm	10	0,350

Nožnice na plech



kód	popis		
229327	250 mm, pravé	6	0,540
229228	250 mm, ľavé	6	0,540

Pílka na kov



kód	popis		
226529	250 mm	24	0,152

Pílka na kov, Plast



kód	popis		
212978	300 mm	12	0,280

Pílka na kov, YB1000



kód	popis		
226251	300 mm	6	0,490

Pílka na kov



kód	popis		
226112	300 mm, plastová rúčka	6	0,330

Pílka na kov so zásobníkom



kód	popis		
226318	300 mm, plastová rúčka	24	2,160

List pílový



kód	popis		
226107	A) Super HSS BI-Metal/8% Cobalt	100	0,200
226194	B) vysoko kvalitná oceľ/HI-Carbon	100	0,200

List pílový na kov



kód	popis		
226258	300 mm	12	0,032

Sponkovačka na káble **STREND PRO**

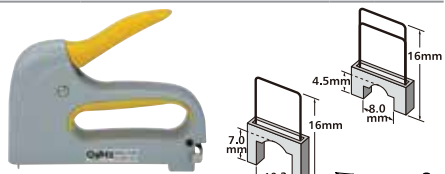

kód	popis	ks	kg
2170619	50ks sponiek na guľatý kábel: 6-8 + 4-6 mm 50ks sponiek na plochý kábel: 4,5-6,3 + 2,5-4 mm	1	

Spony typu: A

Sponkovačka **STREND PRO**



kód	popis	ks	kg
2170616	6-10 mm / Spony typu: C	1	

Sponkovačka **STREND PRO**

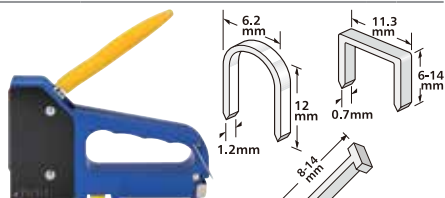

kód	popis	ks	kg
2170618	14 mm / 8-14 mm / 6-14 mm / 12 mm	1	

Spony typu: B klínc / C / D

Sponkovačka **STREND PRO**

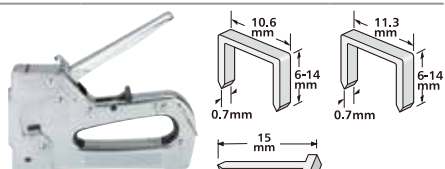

kód	popis	ks	kg
2170617	15 mm / 6-14 mm	1	

Spony typu B klínc / C

Sponkovačka **STREND PRO**

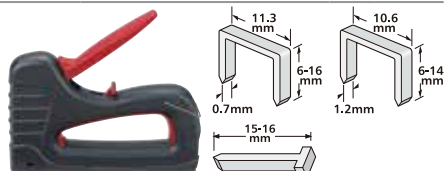

kód	popis	ks	kg
2170615	6-14 mm / 6-16 mm / 15-16 mm	1	

Spony typu: B klínc / C

Sponkovačka **STREND PRO**



kód	popis	ks	kg
2170620	6-10 mm / Spony typu: C	1	

Sponkovačka



kód	popis	ks	kg
217964	A) 4-8 mm	10	0,430
217021	B) 4-14 mm	20	0,700

Sponkovačka



kód	popis	ks	kg
217680	A) 4-8 mm, 200 sponiek	6	0,460
217013	B) 4-14 mm	6	0,521

Sponkovačka **STREND PRO**

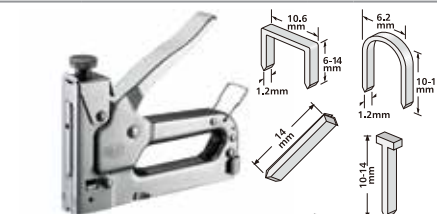

kód	popis	ks	kg
212066	6-14 mm / 10-12 mm / 10-14 mm / 14 mm	1	

Spony typu: B klínc / C / D

Sponkovačka **STREND PRO**



kód	popis	ks	kg
217844	6-10 mm, Spony typu: C	1	

Sponkovačka



kód	popis	ks	kg
217027	4-14 mm	1	1,170
217558	náhradné sponky 1,2x08mm	200	

Spony do sponkovačky, bal.1000



kód	popis	ks	kg
217037	04,00 mm	1000	0,040
217038	06,00 mm	1000	0,055
217039	08,00 mm	1000	0,065
217051	10,00 mm	1000	0,075
217040	12,00 mm	1000	0,090
217024	14,00 mm	1000	0,100

Kliešte viazacie **Rapid**



kód	popis	ks	kg
2170765	pre montáž plotov bez zásobníka spony VR16 a VR22	1	

Kliešte viazacie **Rapid**



kód	popis	ks	kg
2170766	pre montáž plotov so zásobníkom spony VR16	1	
2170767	pre montáž plotov so zásobníkom spony VR22	1	

Spony do viazacích klieští **Rapid**



kód	popis	ks	kg
217408	A) spona VR22, pozinkovaná, 5-11 mm	1600	
2170764	A) spona VR16, pozinkovaná, 2-8 mm	3190	
217194	B) spona VR22, poplastovaná, 5-11 mm	1600	
2170763	B) spona VR16, poplastovaná, 2-8 mm	3190	

Spony do sponkovačky **STREND PRO**

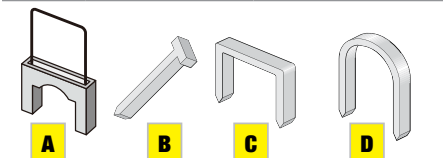

kód	popis	kompatibilné pre:
2170633	A) na kábel 4-6 mm	
2170634	A) na kábel 6-8 mm	
2170635	B) 14x2 mm 9/16"	Arrow 1810; Escó #300; Novus #J; Rocafix #8; Jann Yei: T15
2170636	B) 15x2 mm 11/16"	
2170621	C) 6x11,3 mm 1/4"	
2170623	C) 8x11,3 mm 5/16"	Arrow JT-21; Escó #530; KWB #053; Novus #53; Rapid #53; Rocafix #3; Stanley #A/53;
2170624	C) 10x11,3 mm 3/8"	Jann Yei: 1006F, 1008F, 1010F, 1212F, 1014F
2170625	C) 12x11,3 mm 1/2"	
2170626	C) 14x11,3 mm 9/16"	
2170627	C) 6x10,6 mm 1/4"	
2170628	C) 8x10,6 mm 5/16"	Arrow T50; Escó #S500; KWB #HT057; Novus #11
2170629	C) 10x10,6 mm 3/8"	Rapid #140; Rocafix #4
2170630	C) 12x10,6 mm 1/2"	Jann Yei: 906J, 908J, 910J, 912J, 914J
2170631	C) 14x10,6 mm 9/16"	
2170632	D) 12x6,2 mm 1/2"	Arrow #18; Novus #J-19S; Rapid #28; Jann Yei: 1612



NITOVACIE KLIŠTE / RIVETERS

Kliešte nitovacie



kód	popis		
2290008	300 mm / 3x nitovacie koncovky	20	0,650

Nity: 3.2 4.0 4.8 mm / Použitie nitov: hliník, nerez, oceľ

Kliešte nitovacie



kód	popis		
2290007	360 mm / 5x nitovacie koncovky	10	1,200

Nity: 2.4 3.2 4 4.8 6.4 mm / Použitie nitov: hliník, nerez, oceľ

Kliešte nitovacie v kufríku



kód	popis		
2290005	200 mm / 4x nitovacie koncovky	10	0,700

Nity: M3 M4 M5 M6 / Použitie nitov: hliník, nerez, oceľ

Kliešte nitovacie v kufríku



kód	popis		
2290006	330 mm / 6x nitovacie koncovky	5	1,260

Nity: M3 M4 M5 M6 M8 M10 / Použitie nitov: hliník, nerez, oceľ

Kliešte nitovacie



kód	popis		
229797	200 mm, 2.4-4.8 mm	30	0,600

Kliešte nitovacie / Alu, oceľ, InoX, med'



kód	popis		
229790	CrV, 2.4/3/3.2/4.0/4.8 mm 310 mm, nádobka na nity	20	0,850

Kliešte nitovacie



kód	popis		
229302	250 mm, 2.4-4.8 mm	24	0,580

Kliešte nitovacie



kód	popis		
229244	270 mm, 2.4-4.8 mm	48	0,646

Kliešte nitovacie



kód	popis		
229251	270 mm, 2.4-4.8 mm	48	0,546

Kliešte nitovacie s rotačnou hlavou



kód	popis		
229322	270 mm, 2.4-4.8 mm	24	0,720

Kliešte nitovacie

STANLEY



kód	popis		
229317	4 vymeniteľné vložky pre nity 2, 3, 4 a 5 mm	1	0,600

Kliešte nitovacie



kód	popis		
229341	245 mm / 4v1 / 2.4-4.8 mm	12	0,416

Kliešte nitovacie



kód	popis		
229338	270 mm / CRV / 2.4-4.8 mm	10	1,100

Kliešte nitovacie + nity



kód	popis		
222242	255 mm + 100x nity	24	0,583

Nit Alu, bal. 50 ks



kód	Ø(mm)	L (mm)		
421116	3,2	06,4	25	0,040
421117	3,2	09,6	25	0,040
421118	3,2	12,7	10	0,044
421119	4,0	06,4	10	0,080
421120	4,0	09,6	10	0,096
421121	4,0	12,7	10	0,073
421122	4,0	19,0	10	0,084
421123	4,8	06,4	25	0,084
421124	4,8	09,6	10	0,092
421125	4,8	12,7	10	0,096
421126	4,8	19,0	20	0,150

Sada klíčův očkoplochých Cr-V



kód	popis		
231457	6 dielna, 10-17 mm	1	0,610
231660	8 dielna, 8-19 mm	20	1,470

Sada klíčův očkoplochých Cr-V



kód	popis		
231760	12 dielna, 8-22 mm	10	1,500
2310239	16 dielna, 8-24 mm	10	2,060

Sada klíčův očkoplochých Cr-V



kód	popis		
2310240	22 dielna, 6-32 mm	4	4,200

Sada klíčův trúbkových



kód	popis		
231379	10 dielna, 6-22 mm	4	0,790

Sada klíčův vidlicových



kód	popis		
231175	7 dielna, 6-32 mm	10	1,020

Sada klíčův vidlicových



kód	popis		
231431	12 dielna, 6-34 mm	1	2,000

Sada klíčův vidlicových



kód	popis		
231745	18 dielna, 6-32 mm	10	2,838

Sada klíčův račňových 5 diel.



kód	popis		
2310133	12 dielna, 6x8; 10x12; 11x13; 14x17; 19x21mm	12	0,920

Sada klíčův račňových, 7 dielna



kód	popis		
232397	8-10-12-13-14-17-19 mm otočná hlavica	1	1,550

Sada klíčův očkových Cr-V



kód	popis		
231182	6 dielna, 6-17 mm	1	2,000
231433	8 dielna, 6-22 mm	1	2,000

Obal TETRON



kód	popis		
217673	06 dielna	1	0,010
217677	08 dielna	1	0,010
217668	12 dielna	1	0,010
217579	06 dielna	1	0,010
217580	07 dielna	1	0,010
217581	08 dielna	1	0,010
217582	12 dielna	1	0,010

Sada nastaviteľných klíčův



kód	popis		
231593	multifunkčné, 2ks 10-15mm; 17-32mm	1	0,525

Sada klíčův očkoplochých Cr-V



kód	popis		
231698	12 dielna, 6-22 mm	1	1,120

Sada klíčův račňových

PROFI



Cr-V
CHROM VANADIUM

kód	popis		
231050	10-11-12-13-14-17-19 mm, 7 dielna, račňová	1	1,125

Klúč vidlicový, DIN-895



kód	popis		
231587	6x7	1	0,018
231060	7x8	1	0,020
231805	8x9	10	0,024
231710	8x10	10	0,029
231169	8x11	1	
231605	9x10	10	0,029
231165	10x11	10	0,040
231132	10x12	10	0,031
231216	10x13	48	0,040
231062	10x14	1	0,039
231217	11x13	48	0,043
231828	12x13	1	0,043
231402	12x14	48	0,046
231218	13x14	10	0,048
231403	13x15	10	0,056
231613	13x16	10	0,062
231719	13x17	10	0,066
231404	14x15	10	0,098
231776	14x17	10	0,070
231405	16x17	10	0,077
231606	16x18	10	0,070
231607	17x19	10	0,103
231712	18x19	10	0,091
231604	17x21	48	0,116
231741	18x21	48	0,121
231394	17x22	1	0,200
231720	19x22	10	0,125
231703	20x22	10	0,148
231336	21x23	48	0,174
231406	21x24	48	0,160
231804	19x24	10	0,155
231753	22x24	1	0,185
231507	22x27	1	
231337	24x27	5	0,238
231784	24x30	5	0,288
231407	25x28	5	0,300
231400	27x30	5	0,320
231035	27x32	5	0,388
231718	30x32	5	0,380
231408	30x36	5	0,540
231788	32x36	5	0,538
231409	36x41	5	0,766
2310006	41x46	5	1,000
231969	46x50	5	1,200
231714	50x55	5	1,650
231970	55x60	5	2,050

Klúč Herkules / MaxPower



kód	popis		
2310417	s magnetom / 12 - 19 mm	1	0,611

Klúč vidlicový DIN-894



kód	popis		
231326	17	1	
231467	19	12	0,088
231477	22	12	0,118
231478	24	12	0,146
231479	27	5	0,205
231206	30	6	0,286
231466	32	5	0,308
231563	34	5	0,400
231586	36	5	0,493
231569	38	6	0,538
231163	41	5	0,613
231769	46	5	0,805
231434	50	5	1,100
231436	55	5	1,320

Klúč očkoplochý, DIN-3113, Cr-V



kód	popis		
231684	8	10	0,030
231685	9	10	0,031
231686	10	10	0,038
231687	11	10	0,043
231688	12	10	0,053
231689	13	5	0,064
231690	14	5	0,075
231341	15	48	0,090
231818	16	5	0,101
231280	17	5	0,125
231819	18	5	0,144
231282	19	5	0,170
231652	20	48	0,184
231283	21	5	0,200
231651	22	5	0,218
231728	23	5	0,285
231729	24	48	0,296
231650	25	24	0,316
231699	26	5	0,342
231752	27	5	0,370
231754	28	24	0,440
231755	29	24	0,450
231557	30	5	0,486
231414	32	5	0,570
231648	34	5	0,633
231649	36	5	1,075

Klúč, lešenárska račňa



kód	popis		
231187	19 mm	1	0,780

Klúč očkový, vyhnutý, DIN-838



kód	popis		
231916	08x09	1	0,080
231917	10x11	1	0,080
231344	10x13	48	0,107
231918	12x13	5	0,103
231725	13x15	48	0,146
231727	13x17	48	0,180
231921	14x15	48	0,146
231715	16x17	5	0,190
231920	16x18	1	0,250
231802	17x19	1	0,250
231553	18x19	48	0,236
231594	19x22	48	0,310
231556	20x22	5	0,483
231554	21x23	1	0,350
231423	22x24	48	0,358
231555	24x26	1	0,450
231717	24x27	5	0,392
231422	25x28	24	0,475
231365	27x32	1	0,550
231833	30x32	5	0,615
231647	30x36	5	0,738
231612	32x36	5	0,703
231661	36x41	1	0,670

Klúč krížový, skladací



kód	popis		
2310424	17x19x21x23 mm	20	1,350

Klúč na kolesá, krížový



kód	popis		
2310092	17 - 19 - 21 - 23 mm, matný	16	1,250

Hlavice 1/2"



kód	popis		
232336	08	12	0,055
232337	09	1	0,049
232318	10	12	0,055
232193	11	12	0,055
232194	12	12	0,055
232200	13	12	0,056
232201	14	12	0,058
232195	15	12	0,058
232196	16	12	0,058
232197	17	12	0,064
232198	18	12	0,075
232202	19	12	0,073
232199	20	1	0,090
232203	21	12	0,090
232230	22	12	0,100
232269	23	1	0,106
232268	24	12	0,115
232204	25	1	0,115
232228	26	1	0,130
232270	27	1	0,150
232319	28	1	0,160
232205	29	1	0,380
232273	30	12	0,205
232272	32	1	0,219

Nádstavec



kód	popis		
239205	1/4", 075 mm	10	0,030
239206	1/4", 150 mm	1	0,145
239193	3/8", 075 mm	10	0,080
239194	3/8", 250 mm	1	0,240
239192	1/2", 075 mm	10	0,140
239164	1/2", 125 mm	1	0,228
239191	3/8", 125 mm	10	0,135
239165	1/2", 250 mm	1	0,440

Kardaň univerzálny



kód	popis		
239235	1/4", 040 mm	1	0,030
239177	3/8", 050 mm	1	0,050
239217	1/2", 068 mm	10	0,165

Kolovrátok



kód	popis		
239419	1/2", 400 mm	1	0,525

Račňa s páčkou, 36 zubov



kód	popis		
239215	1/4"; 25x146 mm	10	0,120
239188	3/8"; 31x200 mm	10	0,291
239214	1/2"; 41x255 mm	10	0,588

Redukcia



kód	popis		
239239	1/4" -> 3/8"	1	0,100
239241	3/8" -> 1/2"	1	0,100
239324	3/8" -> 1/4"	1	0,050
239243	1/2" -> 3/8"	10	0,060
239237	1/2" -> 3/4"	10	0,235
239242	3/4" -> 1/2"	10	0,230

Vrátidlo



kód	popis		
239244	1/4", 115 mm	10	0,038
239245	3/8", 165 mm	10	0,165
239246	1/2", 250 mm	10	0,440
239323	1/2", 250 mm	10	0,440

Stojan na hlavice



kód	popis		
239525	414x360x351 mm	1	9,200

Račňa s páčkou, 24 zubov



kód	popis		
239500	3/4"; 62x510 mm	1	0,270

Račňa s páčkou, 36 zubov



kód	popis		
239047	1/2"; 41x255 mm	10	0,580

Račňa s kolieskom, 72 zubov



kód	popis		
239248	1/2"; 40x263 mm	10	0,525
239249	3/8"; 36x203 mm	12	0,340
239132	1/4"; 26x143 mm	12	0,133

Račňa s kolieskom, 72 zubov



kód	popis		
239162	1/2"; 39x250 mm	15	0,550
239131	1/4"; 26x145 mm	25	0,120

Račňa s kolieskom, 32 zubov



kód	popis		
239160	1/2"; 40x245 mm	10	0,630

Račňa s kolieskom, 72 zubov



kód	popis		
239016	1/2"; 40x245 mm	10	0,530

Račňa s páčkou, 32 zubov



kód	popis		
239404	1/4"; 25x146 mm	1	0,153
239405	1/2"; 41x260 mm	1	0,600

Račňa s kolieskom, 72 zubov



kód	popis		
239297	1/4"; 27x145 mm	10	0,105
239295	1/2"; 41x255 mm	10	0,610

Sada hlavíc 12 hranná, 10 dielna



1/2" 10 11 12 13 14 15 17 19 22 24 mm



kód	popis		
239202	1/2", 10 dielna, (10-24 mm)	1	0,400

Sada hlavíc 25 dielna



1/4" 4 4.5 5 5.5 6 7 8 9 10 11 12 13 14 mm



1/4"



1/4" DR. S.A.E. 5/32" 3/16" 7/32" 1/4" 9/32" 5/16"

11/32" 3/8" 13/32" 7/16" 15/32" 1/2"



kód	popis		
239322	1/4" (4-13 mm)	1	0,620

Sada hlavíc 19 dielna

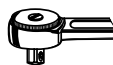

1/2"



1/2" 8 9 10 11 12 13 14 15 16 17
19 21 22 23 24 27 30 32 mm



kód	popis		
239063	1/2" (8-32 mm)	1	1,400

Sada hlavíc 24 dielna



3/8" 8 9 10 11 12 13 14 15 17 19 22 mm



3/8"



3/8" PhillipS: 1, 2 Slotted: 4, 4.5, 7mm

Star: T15, T20, T25, T30 Hex: 4, 5, 6mm



kód	popis		
239320	3/8" (8-19 mm)	1	1,120

Sada hlavíc 13 dielna



3/8" 8 9 10 11 12 13 14 15 16 17 19 mm



1/2"



1/2" 125 mm



kód	popis		
239259	1/2" (8-22 mm) 13 dielna	6	1,950

Sada hlavíc 17 dielna



1/4" - 4 4.5 5 5.5 6 7 8 9 10 11 12 13 mm



1/4"



2" 4"



1/4"









1/4"





kód	popis		
239103	1/4" (4-13 mm)	6	1,100

Sada hlavíc 37 dielna











-  3/8" - 9 10 11 12 13 14 15 16 17 19 mm
-  3/8"  1/4" - 4 4,5 5 5,5 6 7 8 9 mm
-  3/8" - 21 mm
-  75 mm 150 mm
-  1/4"
-  1/4" - 12 ks

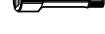

kód	popis		
239290	37dielna, 1/4"+3/8" (9-19mm)	6	2,200

Sada hlavíc 41 dielna

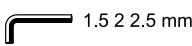





-  1/4" 4 4,5 5 5,5 6 7 8 9 10 11 12 13 mm
-  1/4" 4 5 6 7 8 9 10 11 13 mm
-  25 mm : (+) 1 2 3 (-) 4 5 5,7 (o) 3 4 5 6 7 8
-  1/4"
-  1/4"
-  1/4" 50 mm  1.5 2 2.5 mm
-  1/4"



kód	popis		
239199	1/4" (4-13 mm) 41 dielna	10	1,200

Sada hlavíc 17 dielna







-  1/2" - 10 11 12 13 14 15 17 19 21 22 24 mm
-  1/2"
-  1/2" 125 mm 250 mm
-  1/2" 21 mm
-  1/2"



kód	popis		
239159	1/2" (10-24) 17 dielna	6	3,040

Sada hlavíc 16 dielna









-  1/4" - 4 4,5 5 5,5 6 7 8 9 10 11 12 13 mm
-  1/4"
-  1/4" - 50 mm
-  1/4"
-  1/4"



kód	popis		
239064	1/4" (4-13 mm) 16 dielna	10	0,950

Sada hlavíc 21 dielna









-  3/8" (6-8-10-11-12-13-14-15-17-19-21-22-24 mm)
-  3/8"
-  (16-21 mm)
-  3/8"
-  3/8" (45-75-125 mm)
-  3/8"



kód	popis		
239061	3/8" (6-24 mm) 21 dielna	6	2,100

Sada hlavíc 25 dielna









-  1/2" (8-9-10-11-12-13-14-15-16-17-18-19-21 22-24-27-30-32 mm)
-  1/2"
-  1/2"
-  1/2"
-  1/2" (125-250 mm)
-  1/2" (16-21 mm)

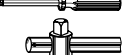

kód 239158 popis 1/2", 25 dielna 6 4,470

Sada hlavíc 32 dielna







-  1/4" 4 4.5 5 5.5 6 7 8 9 10 11 12 13 mm
-  25 mm : (+) 1 2 3 (-) 4 5.5 7 (o) 3 4 5 6 7 8
-  1/4"
-  1/4"
-  1/4" 50 mm
-  1.5 2 2.5 mm
-  1/4"



kód 239062 popis 1/4" (4-13 mm) 32 dielna 6 1,000

Sada hlavíc 21 dielna



-  1/2" 10 11 12 13 14 15 16 17 18 19 21 22 24 27 30 32 mm
-  1/2"
-  1/2"
-  1/2" 3" 5"



kód 239252 popis 1/2" (10-32 mm) 21 dielna 6 3,360

Sada hlavíc 73 dielna



-  1/4" 5 6 7 8 9 10 11 12 13 mm
-  1/2" 10 11 12 13 14 15 17 19 22 24 mm
-  1/2" Redukcia 1/2"
-  1/2" Rukoväť skrutkovač 2x
-  1/2" Kľúče očkoploché 10 11 12 13 14 15 17 19 mm
-  1/2" Kľúče Hex 2,5 3 4 5 6 8 10
-  1/2" 250 mm Kladivo 300 g
-  1/2" 16 21 mm Kliešte SICO 250 mm
-  1/2" 16 21 mm Kliešte Combi 160 mm
-  1/2" 16 21 mm Skrutkovače 3x ploché, 2x PH
-  1/2" 16 21 mm Bity 22 ks
-  1/2" 16 21 mm Skúšačka 220-250V



kód 239247 popis 1/4"+1/2", 73 dielna 3 6,160

Sada kľúčov očkoplochých 17 dielna



-  6, 7, 8, 9, 10, 11, 12, 13, 14, 15, 16, 17, 18, 19, 20, 21, 22 mm



kód 231049 popis 17 dielna 1 2,125

Sada hlavíc 94 dielna



- 1/2" 10 11 12 13 14 15 16 17 18 19 20 21 22 24 27 30 32 mm
- 1/4" 4 4.5 5 5.5 6 7 8 9 10 11 12 13 14 mm
- 1/2" L77 mm - 14 15 17 19 22 mm
- 1/4" L50 mm - 6 7 8 9 10 11 12 13 mm
- 1/4" Bit hlavica - PH1 2 - TX1 2 - PLO4 5,5 7 - HexIn 7x 08 mm L30 - 16x
- 1/2" 125 250 mm
- 1/4" 050 100 mm
- 1/4"
- 1/2" a 1/4"
- 1/4" 1/2" 16 mm 21 mm
- 1/2" a 1/4" 1/4"



kód 239292 popis 1/4" (4-14 mm), 1/2" (10-32 mm), 94 dielna 6 6,700

Sada hlavíc 99 dielna



- 1/4" 3.2 4 4.5 5 5.5 6 7 8 9 10 11 12 13 mm
- 3/8" 9 10 11 12 13 14 15 16 17 18 19 mm
- 1/2" 14 15 16 17 18 19 20 21 22 23 24 27 30 32 mm
- 3/8"(F), 1/4"(M), 3/8"(F), 1/2"(M), 1/2"(F), 3/8"(M)
- 1/4" 50, 150 mm, 3/8" 75, 150 mm, 1/2" 125, 250 mm
- 1/4" Phillips: 1, 2, 3 Pozi: 1, 2, 3 Slotted: 4, 5.5, 7mm
- Star: T10, T15, T20, T25, T30, T40 Hex: 3, 4, 5, 6, 7, 8mm
- 5/16" Phillips: 3, 4 Pozi: 3, 4 Slotted: 8, 10, 12 mm
- Star: T40, T45, T50, T55 Hex: 8, 10, 12, 14 mm
- 3/8" DR. *5/16" HEX, 1/2"DR. * 5/16" HEX
- 3/8" 14, 18 mm, 1/2" 16, 21 mm
- 1.5, 2.0, 2.5 mm
- 1/4" 3/8" 1/2"
- 1/4" 3/8" 1/2"
- 1/4"



kód 239417 popis 1/4", 3/8", 1/2", 99 dielna 1 7,160

Sada hlavíc 111 dielna



- 1/4" 3.2 4 4.5 5 5.5 6 7 8 9 10 11 12 13 mm
- 3/8" 9 10 11 12 13 14 15 16 17 18 19 mm
- 1/2" 14 15 16 17 18 19 20 21 22 23 24 27 30 32 mm
- 3/8"(F), 1/4"(M), 3/8"(F), 1/2"(M), 1/2"(F), 3/8"(M)
- 1/4" 50, 150 mm, 3/8" 75, 150 mm, 1/2" 125, 250 mm
- 1/4" Phillips: 1, 2, 3 Pozi: 1, 2, 3 Slotted: 4, 5.5, 7mm
- Star: T10, T15, T20, T25, T30, T40 Hex: 3, 4, 5, 6, 7, 8mm
- 5/16" Phillips: 3, 4 Pozi: 3, 4 Slotted: 8, 10, 12 mm
- Star: T40, T45, T50, T55 Hex: 8, 10, 12, 14 mm
- 8 9 10 11 12 13 14 15 16 17 18 19 mm
- 3/8" DR. *5/16" HEX, 1/2"DR. * 5/16" HEX
- 3/8" 14, 18 mm, 1/2" 16, 21 mm
- 1.5, 2.0, 2.5 mm
- 1/4" 3/8" 1/2"
- 1/4" 3/8" 1/2"
- 1/4"



kód 239418 popis 1/4", 3/8", 1/2", 111 dielna 1 7,660

Sada hlavíc 59 dielna



- 1/4" 4 4.5 5 5.5 6 7 8 9 10 11 12 13 mm
- 1/2" 10 11 12 13 14 15 17 19 21 22 24 27 30 32 mm
- 1/4"
- 1/2" 16, 21 mm
- 1/4"
- 1.5 2 2.5 mm
- 1/4" 1/2"
- 1/4" PL 4, 5.5, 7 PH 1, 2, 3 PZ 1, 2 TX 10, 15, 20, 25, 27, 30 AL 4, 5, 6, 8
- 1/4" 100 mm 1/2" 125, 250 mm 1/2"(M) x 3/8"(F) T-M
- 1/4" 1/2"



kód 239058 popis 1/2" (10-32 mm), 1/4" (4-13 mm) 6 5,600

Sada hlavíc 25 dielna



- 1/2" 10 11 12 13 14 15 16 17 18 19 20 21 22 23 24 27 30 32 mm
- 1/2"
- 1/2"
- 1/2" 125 250 mm
- 1/2" 16, 21 mm
- 1/2"









kód 239059 popis 1/2" (10-32 mm) 6 5,400

WORKSHOP

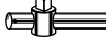
Sada hlavíc 25 dielna









-  1/2" 10 11 12 13 14 15 16 17 18
19 20 21 22 23 24 27 30 32 mm
-  1/2"
-  1/2"  1/2" 16 21 mm
-  1/2" 125 250 mm  1/2"



kód 239251 popis 1/2" (10-32 mm) 6 4,520

Sada hlavíc 28 dielna

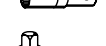

-  1/2" 8 9 10 11 12 13 14 15 16 17 18 19 mm
20 21 22 23 24 27 30 32 mm
-  1/2"
-  1/2" 5" 10"  1/2"
-  1/2" 16 21 mm  1/2"
-  1/2"



kód 239150 popis 1/2" (8-32 mm) 6 6,050

Sada hlavíc 108 dielna



- 18 ks 1/4" Zástrčná hlavica
SL 4, 5.5, 6.5 / PH 1, 2 / PZ 1, 2 / HEX 3, 4, 5, 6 / T 8, 10, 15, 20, 25, 27, 30
- 13 ks 1/4" Hlavica 4, 4.5, 5, 5.5, 6, 7, 8, 9, 10, 11, 12, 13, 14 mm
- 8 ks 1/4" Predĺžená hlavica 6, 7, 8, 9, 10, 11, 12, 13 mm
- 2 ks 1/4" Predĺžovací nadstavec 50, 75 mm
- 1 ks 1/4" Kardaň
- 1 ks 1/4" Račňa
- 5 ks 1/4" TORX® Hlavica E4, E5, E6, E7, E8
- 1 ks 1/4" Vrátidlo
- 1 ks 1/4" Nadstavec na hlavice
- 17 ks 1/2" Hlavica 10, 11, 12, 13, 14, 15, 16, 17, 18, 19,
20, 21, 22, 24, 27, 30, 32 mm
- 5 ks 1/2" Predĺžená hlavica 14, 15, 17, 19, 22 mm
- 2 ks 1/2" Predĺžovací nadstavec 110, 250 mm
- 1 ks 1/2" Kardaň
- 8 ks 1/2" TORX® Hlavica E10, E11, E12, E14, E16,
E18, E20, E24
- 1 ks 1/2" Račňa
- 2 ks 1/2" Hlavica na sviečku 16, 21 mm
- 1 ks Vrátidlo
- 3 ks Inbusový kľúč 1.5, 2, 2.5 mm
- 17 ks bit
SL 8, 10, 12 / T 40, 45, 50, 55, 60 / PH 3, 4 / PZ 3, 4
HEX 7, 8, 10, 12, 14
- 1 ks Držiak bitov



kód 239679 popis 1/4", 108 dielna 1 6

Sada hlavíc 215 dielna















- 13 ks 1/4" Hlavica 4-14 mm
- 10 ks 3/8" Hlavica 10-19 mm
- 15 ks 1/2" Hlavica 10-32 mm
- 7 ks 1/4" Predĺžená hlavica 4, 5, 6, 7, 8, 9, 10 mm
- 6 ks 3/8" Predĺžená hlavica 10, 11, 12, 13, 14, 15 mm
- 5 ks 1/2" Predĺžená hlavica 16, 17, 18, 19, 22 mm
- 5 ks 1/2" TORX® Hlavica E4, E5, E6, E7, E8 mm
- 6 ks 3/8" TORX® Hlavica E10, E11, E12, E14, E16,
E18 mm
- 3 ks 1/2" TORX® Hlavica E20, E22, E24 mm
- 1 ks 3/8" Hlavica na sviečku 21 mm
- 2 ks 1/2" Hlavica na sviečku 16 a 21 mm
- 2 ks 1/4" Predĺžovací nadstavec 2", 4"
- 1 ks 3/8" Predĺžovací nadstavec 5"
- 2 ks 1/2" Predĺžovací nadstavec 5", 10"
- 1 ks 1/2" Vrátidlo
- 1 ks 1/4" Vrátidlo
- 3 ks Kardaň 1/4", 3/8", 1/2"
- 1 ks 1/4" 6 mm Držiak bitov
- 1 ks 3/8" 8 mm Držiak bitov
- 1 ks 1/2" 8 mm Držiak bitov
- 1 ks 1/4" Nadstavec na hlavice
- 1 ks Držiak skrutkovačov
- 30 ks bit 8x30
- 44 ks bit 6x25
- 30 ks 1/4" Zástrčná hlavica
- 2 ks 1/2" Zástrčná hlavica T55, T60
- 7 ks Inbusový kľúč 1, 1.5, 2, 2.5, 3, 4, 5
- 12 ks Očkoplochý kľúč 8-22 mm
- 3 ks Račňa 1/4", 3/8", 1/2"



kód 239678 popis 1/4", 3/8", 1/2", 215 dielna 1 6

Sada hlavíc 94 dielna



-  1/2" 10 11 12 13 14 15 16 17 18 19 20 21 22 24 27 30 32 mm
-  1/4" 4 4.5 5 5.5 6 7 8 9 10 11 12 13 14 mm
-  1/2" L77 mm - 14 15 17 19 22 mm
-  1/4" L50 mm - 6 7 8 9 10 11 12 13 mm
-  1/4" Bit hlavica - PH1 2 - TX1 2 - PLO4 5.5 7 - HexIn 7x
08 mm L30 - 16x
-  1/4"  1/2" a 1/4"  1,5 2 2,5 mm
-  1/4"  1/2" 16 mm 21 mm
-  1/2" 125 250 mm
-  1/4" 050 100 mm  1/2" a 1/4"

kód 239580 popis 1/4" (4-14 mm), 1/2" (10-32 mm), 94 dielna 6 6,700

Sada hlavíc 187 dielna

STREND PRO



- 1 ks Štikacie kliešte 180 mm
- 1 ks Francúzsky kľúč 200 mm
- 1 ks Nastaviteľné kliešte 250 mm
- 1 ks Kliešte na poistné krúžky 180 mm
- 1 ks Kombinované kliešte 150 mm
- 10 ks Očkoplochý kľúč 8-19 mm
- 6 ks Mikro skrutkovač: s/d 1.0, 1.4, 1.8, 2,4 mm / # 0, 1
- 9 ks Inbusový kľúč: 1.5 - 10 mm
- 24 ks bit: V 3-7 / VPH 0-4 / VPZ 1-2 / VT 10-35 / V. 3-8
- 1 ks Skrutkovač na bity
- 1 ks Držiak bitov
- 1 ks Račňa
- 14 ks Skrutkovač: (-) 3x75, 4x100, 5x75, 6x38, 6x100 mm (+) 3x75, 4x100, 5x75x 6x38, 6x100, 8x150 mm Izolované (-) 4x100, 5.5x100 mm Izolované (+) 4x100 mm
- 1 ks Bit na háčiky
- 12 ks 1/4" Hlavica 4-13 mm
- 17 ks 1/2" Hlavica 10-30 mm
- 2 ks 1/2" Hlavica na sviečky 16,21 mm
- 2 ks 1/2", 1/4" Kardaň
- 2 ks 1/2", 1/4" Vrátidlo
- 3 ks 1/2x5", 1/4x2", 4" Predĺžovací nadstavec
- 1 ks Pružný nadstavec 150 mm
- 1 ks 1/4" Nadstavec na hlavice 150 mm
- 2 ks 1/2", 1/4" Račňa
- 2 ks Nylonová svorka
- 60 ks Viazacia páska
- 1 ks Obuvnícke kladivo
- 1 ks Krimpovacie kliešte
- 1 ks Meter
- 1 ks Tavná pištoľ + tavné tyčinky
- 1 ks Orezávací nôž
- 1 ks Izolačná páska
- 1 ks Hliníková vodováha
- 1 ks Uzamykací kufrík
- 1 ks Magnetický skrutkovač
- 1 ks Skúšačka

NOVINKA

kód

239677

popis

1/4", 1/2", 187 dielna



1



Sada hlavíc 37 dielna

STREND PRO



- 19 ks 1/2" Hlavica 8, 9, 10, 11, 12, 13, 14, 15, 16, 17, 18, 19, 20, 21, 22, 24, 27, 30, 32 mm
- 2 ks 1/2" Hlavica na sviečku 16, 21 mm
- 1 ks 1/2" Kardaň
- 1 ks Predĺžovací nadstavec 250 mm
- 1 ks Vrátidlo
- 1 ks 1/2" Račňa
- 12 ks Očkoplochý kľúč 8, 9, 10, 11, 12, 13, 14, 15, 16, 17, 18, 19 mm

NOVINKA

kód

239673

popis

1/2", 37 dielna



1



Sada hlavíc 46 dielna

STREND PRO



- CT124601-1
- 13 ks 1/4" Hlavica 4, 4.5, 5, 5.5, 6, 7, 8, 9, 10, 11, 12, 13, 14 mm
- 21 ks 1/4" Zástrčna hlavica SL 4, 5.5, 7 / PH 1, 2, 3 / PZ 1, 2, 3 / HW 3, 4, 5, 6, 7, 8 / T 10, 15, 20, 25, 30, 40
- 3 ks Inbusový kľúč 1.5, 2, 2.5 mm
- 1 ks 1/4" Kardaň
- 2 ks 1/4" Predĺžovací nadstavec 2", 4"
- 1 ks 1/4" Pružný nadstavec 6"
- 1 ks 1/4" Vrátidlo
- 1 ks 1/4" Račňa
- 1 ks 1/4" Nadstavec na hlavice
- 1 ks 1/4" Adaptér na bity
- 1 ks Uzamykací kufrík

NOVINKA

kód

239672

popis

1/4", 46 dielna



1



Sada hlavíc 64 dielna

STREND PRO



- 9 ks 1/4" Hlavica 5, 5.5, 6, 7, 8, 9, 10, 11, 12 mm
- 14 ks 1/2" Hlavica 8, 9, 10, 11, 12, 13, 14, 15, 16, 17, 19, 21, 22, 24 mm
- 1 ks 1/2" 150 mm Predĺžovací nadstavec
- 1 ks 1/2" Račňa 200 mm
- 9 ks Inbusový kľúč
- 1 ks Skrutkovač na bity
- 2 ks Mikro skrutkovač
- 1 ks 10" Upínacie kliešte
- 1 ks 3x16 mm Meter
- 1 ks 300 g Kladivo
- 1 ks 7" Kombinované kliešte
- 1 ks 6" Kliešte na poistné krúžky
- 20 ks Bit
- 1 ks Plastový držiak
- 1 ks Kovový kufrík

NOVINKA

kód

239675

popis

1/4", 1/2", 64 dielna



1



IMBUSOVÉ KLÍČE / HEXAGONAL KEYS

Sada klíčův Torx



kód	popis		
2310130	9 dielna - T10; T15; T20; T25; T27; T30; T40; T45; T50	5	0,330

Sada klíčův Torx



kód	popis		
231223	9 dielna - T10; T15; T20; T25; T27; T30; T40; T45; T50	10	0,760

Sada klíčův, Hex s guličkou



kód	popis		
2310225	9 dielna, dlhá 1,5; 2; 2,5; 3; 4; 5; 6; 8; 10mm	5	0,380

Sada klíčův, Hex s guličkou



kód	popis		
2310024	9 dielna, krátka 1,5; 2; 2,5; 3; 4; 5; 6; 8; 10mm	48	0,340

Sada klíčův, Imbus-Hex



kód	popis		
2310222	10 dielna - 1,5; 2; 2,5; 3; 4; 5; 5,5; 6; 8; 10mm	10	0,380

Sada klíčův, Imbus-Hex s guličkou



kód	popis		
2310014	9 dielna - 1,5; 2; 2,5; 3; 4; 5; 6; 8; 10mm	12	0,300

Sada klíčův, Imbus-Hex



kód	popis		
231235	9 dielna, 1,5; 2,0; 2,5; 3,0; 4,0; 5,0; 5,5; 6,0; 8,0 mm	25	0,160

Sada klíčův Hex



kód	popis		
2310223	7 dielna - 2; 2,5; 3; 4; 5; 6; 8mm	1	0,510

Sada klíčův Torx



kód	popis		
2310224	8 dielna - T9; T10; T15; T20; T25; T27; T30; T40	10	0,200

Sada klíčův predĺžených



kód	popis		
2310310	9 dielna, Hex, Cr-V 1,5-2,0-2,5-3,0-4,0-5,0-6,0-8,0-10 mm	1	0,625

Sada klíčův predĺžených



kód	popis		
2310309	9 dielna, Torx, Cr-V T10-T15-T20-T25-T27-T30-T40-T45-T50	1	0,600

Klíč, Imbus-Hex



kód	popis		
2310081	01.5 mm		0,030
2310082	02.0 mm		0,030
2310083	02.5 mm		0,030
2310084	03.0 mm		0,006
2310085	04.0 mm		0,011
2310086	05.0 mm		0,019
2310087	06.0 mm		0,033
2310088	07.0 mm		0,045
2310089	08.0 mm		0,068
2310090	09.0 mm		0,060
2310091	10.0 mm		0,120
2310290	12.0 mm		0,100
2310291	14.0 mm		0,290
2310292	17.0 mm		0,500
2310293	19.0 mm		0,638
2310294	22.0 mm		1,100

Súprava na opravu bicykla



kód	popis		
252059	záplaty + klíče	50	0,300

Sada náradia



kód	popis		
239356	A) dielenská 1x kľúč francúzky 200 mm / 1x kľúč Hex • 2-2,5-3-4-5-6 mm 1x kliešte štikacie 155 mm / 1x kliešte kombinované 180 mm 1x skrutkovač na bity / 10x bity	20	1,280
239479	B) dielenská 1x kľúč francúzky 200 mm / 1x kliešte s dlhým nosom 150 mm 1x kliešte kombinované 180 mm / 1x skrutkovač mini (PLO) 2,4x40 mm 1x skrutkovač mini (PH) 00x40 mm / 1x skrutkovač na bity / 10x bity 5x hlavica 25 mm	1	1,250

Sada náradia



kód	popis		
239478	dielenská 1x kľúč francúzky 200 mm / 9x kľúč Hex • 1,5-2-2,5-3-4-5-6-8-10 mm 1x kliešte kombinované 180 mm, 1x skúšačka "pero" / 1x skrutkovač na bity	1	1,125

Sada náradia



kód	popis		
239120	elektrikárska 1x skrutkovač PLO • 5x75 mm / 1x skrutkovač PH • 1x75 mm 1x kľúč nastaviteľný 150 mm / 1x skrutkovač mini PLO • 5x75 mm 1x skrutkovač mini PH • 1x75 mm / 1x sada kľúčov Hex • 2-2,5-3-4-5-6 1x multimeter / 1x kliešte štikacie, bočné 125 mm 1x kliešte s dlhým nosom 125 mm / 1x skúšačka 1x sada kľúčov Hex • 2-2,5-3-4-5-6 mm	20	1,100

Sada náradia



kód	popis		
239350	dielenská 1x skrutkovač PLO • 6x125 mm / 1x skrutkovač PH • ? / 1x svetlo Al 1x nôž odlamovací / 1x meter výsuvný 3 m, 16 mm 1x sada kľúčov Hex • 1,5-2-3-4-5-5,5-6-8-10 mm 1x pílkla skladacia 180 mm / 1x nožnice 200 mm 1x kliešte s dlhým nosom 150 mm / 1x kliešte kombinované 175 mm 1x kľúč nastaviteľný 200 mm / 1x skrutkovač mini PLO • 2,4x40 mm 1x skrutkovač mini PH • 00x40 mm / 1x kladivo zámočnicke 300 g 1x kliešte nastaviteľné 250 mm	8	3,560

Sada náradia



kód	popis		
239355	dielenská 1x kľúč francúzky 200 mm / 1x kľúč Hex • 2-2,5-3-4-5-6 mm 1x kliešte s dlhým nosom 150 mm / 1x kliešte kombinované 180 mm 1x skúšačka "pero" / 1x nôž odlamovací / 2x skrutkovač (-), (+)	20	1,230

Sada náradia



kód	popis		
239353	dielenská 6x kľúč očkoplochý • 8-10-12-14-17-19 mm 1x meter výsuvný 3 m / 1x nôž odlamovací / 1x kliešte kombinované 180 mm 1x kliešte nastaviteľné 250 mm / 10 sada bitov 1x skúšačka "pero" / 1x kladivo sklolaminát 300 g 1x skrutkovač, nástavec na bity	12	2,460

Sada náradia



kód	popis		
239354	dielenská 2x skrutkovač (-), (+) / 1x rezač rúrok / 1x kľúč francúzky 200 mm 1x kliešte kombinované 180 mm / 9x kľúč Hex • 1,5-2-3-4-5-5,5-6-8-10 1x nôž odlamovací / 1x meter výsuvný oceľový 3 m 9x kľúč Hex • 1,5-2-3-4-5-5,5-6-8-10 mm 1x skúšačka "pero" / 1x kliešte nastaviteľné 250mm	12	2,420

Sada náradia



kód	popis		
239351	dielenská 1x páska izolačná PVC / 1x kliešte nastaviteľné 250 mm 1x sada kľúčov HexBall 9 dielna / 1x kliešte s dlhým nosom 150 mm 1x kliešte kombinované 175 mm / 1x skrutkovač mini PLO • 2,4x40 mm 1x skrutkovač mini PH • 00x40 mm / 2x skrutkovač PLO • 5x75-6x120 mm 2x skrutkovač PH • 1x75-2x125 mm / 1x meter výsuvný 3 m, 13 mm 1x skúšačka / 1x kladivo zámočnicke 300 g 1x nôž odlamovací / 1x kľúč nastaviteľný 200 mm	8	2,870

Sada náradia pre ženy, Ladies Set



kód	popis		
233304	39 dielna 8x imbusové kľúče: 1,5; 2; 2,5; 3; 4; 5; 5,5; 6 mm / 20x bity 1x skrutkovač na bity / 1x držiak magnetický / 1x kliešte kombinované 4x skrutkovače / 1x odlamovací nožik 18 mm / 1x obuvnicke kladivo 1x meter stáčač 3 m / 1x nožnice / 1x plastový kuľor	8	1,500

Sada náradia



kód	popis		
239352	dielenská 4x skrutkovač (+) 5, 6, (+) 5, 6 / 1x kladivo sklolaminát 300 g 1x páska izolačná / 1x kľúč francúzky 200 mm 1x kliešte kombinované 180 mm, 1x nôž odlamovací 1x meter výsuvný oceľový 3 m / 9x kľúč Hex • 1,5-2-3-4-5-5,5-6-8-10 mm 4x pilník 200 mm, PLO-3HR-OKR-USEC / 1x kliešte s dlhým nosom 150 mm	12	3,500

Sada náradia



kód	popis		
239487	39 dielna 12x skrutkovačov - PL 2.0x75, 2.5x75, 3.0x75, 4.0x75 mm; PH 2.0x75, 2.5x75mm, 3.0x75 mm; TX (T6, T7, T8, T9, T10) x3mmx75mm / 1ks - račňová rukoväť / 6ks - mini kliešte: štikacie, diagonálne, s dlhým nosom, štikacie čelné, s plochým nosom, s extra dlhým nosom / 20x bity - 25mm Cr-V bitov PL 3-4-5-6 / PH 1-2-3 / PZ 1-2-3 / SD 0-1-2-3 / Torx:10-15-20-25-30-40	1	1,500

Sada náradia



kód	popis		
239485	34 dielna 7x skrutkovačov - PL 4x100, 5x75, 6x100, 8x150 mm; PH 0x75, 1x75, 2x100 mm / 1ks - 200mm nástavec / 1ks - 150 nastaviteľný kľúč / 1ks - račňa / 1ks - 150mm kliešte kombinované, 1ks - štikacie, 1ks - s dlhým nosom / 1ks - 190,5mm kliešte nastaviteľné / 20ks - 25mm Cr-V bitov	1	2,400

Sada skrutkovačov 5diel.



kód	popis		
225552	PL 3x75, 5x100, 6x150 PH 1x75, 2x100	20	0,650

Sada skrutkovačov 6diel.



kód	popis		
225079	PL 3x75, 5x100, 8x150 PH 1x75, 2x100	20	0,650

Sada skrutkovačov 8diel.



kód	popis		
225083	PL 3.5x80, 4x75, 5.5x100, 6.5x150, 8x150, PH 0x75, 1x75, 2x100	20	0,700

Sada skrutkovačov 6diel.



kód	popis		
225347	PL 5x75, 6x100, 6x125, 8x150 PH 1x75, 2x100	12	0,950

Sada skrutkovačov 6diel.



kód	popis		
2250017	PL 3x75; 5x100; 6x150mm PH 0x75; 1x75; 2x100mm	6	0,500

Sada skrutkovačov 7diel.



kód	popis		
2250001	PL 3x75; 5x75; 6x100; 8x150mm PH 3x75; 5x75; 6x100mm	20	0,500

Sada skrutkovačov Torx 6diel.



kód	popis		
225979	T10x75; T15x100; T20x100; T25x100; T30x100; T40x100 mm	20	0,800

Sada skrutkovačov



kód	popis		
2250190	PH 2x150; 2x100; 1x75; 0x75 PL 8x150; 6x150; 6x100; 5x75; 3x75 mm	6	1,080

Sada skrutkovačov/úderové/6 diel.



kód	popis		
2250005	PL - 5x100; 5x150; 6x150 mm PH - 1x100; 1x150; 2x150mm	6	0,900

Sada skrutkovačov



kód	popis		
2250188	4 dielna PH 1x75; 2x100; 5x75 mm PL 6x100 mm	6	0,471
2250189	6 dielna PL 6x38; 5x75; 6x100 PH 2x100; 1x75; 2x38 mm	6	0,600

Sada skrutkovačov



kód	popis		
2250191	PH 3x150; 2x100; 1x75; 2x38 0x40; 00x40 mm PL 8x150; 6x100; 5x75; 6x38 2.4x40; 3.0x40 mm T5; T6; T7; T8; T9; T10x40 mm	4	1,144

Sada skrutkovačov

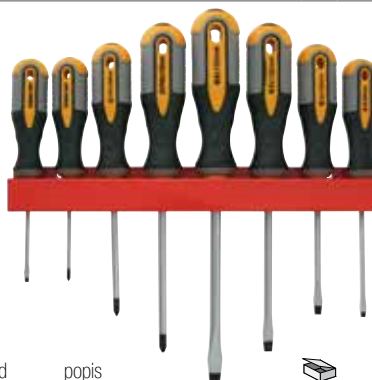

kód	popis		
2250162	PH 2x125; 1x100; 0x75 mm PL 8x150; 6x125; 5x100; 4x100; 3x75 mm	6	1,083

SADY SKRUTKOVÁČOV / SET OF SCREWDRIVERS

Sada skrutkovačov, Precision



kód	popis		
2250019	PL 3x50; 2,5x50; 2x50 mm PH 0x50; 00x50; 000x50 mm	6	0,190

Sada skrutkovačov, 6 diel., elektri.



kód	popis		
2250018	PL 3x75; 5,5x100; 6,5x125mm PH 0x60; 1x80; 2x100mm	6	0,120

Sada skrutkovačov, bitov



kód	popis		
225935	18 dielna 6x Skrutkovače / 7x Bity 4x Hlavice / 2x Nastavce	12	0,950

Sada skrutkovačov



kód	popis		
2250016	19 dielna PL 3;5;5,5;6,5mm / PH0; PH1; PH2 TRX T10; T15; T20; T25; T27; T30 Hlavice 5; 6; 7; 8; 9; 10; 11mm	5	0,420

Držiak magnetický



kód	popis		
222920	pero / teleskopický 133-645 mm	1	0,060

Sada Skrutkovačov



kód	popis		
2310311	10 dielna, Hex, T-držiak H2, H2.5, H3, H4, H5, H5.5, H6, H8, H10, H12	1	1,800

Sada skrutkovačov



kód	popis		
225943	22 dielna; 38x6; 250x6; 200x6; 75x3; 75x4; 100x5; 150x5; 100x4; 100x5T25; 100x5T20; 100x5T15; 75x4T10; 100x6T30; 150x5	10	1,100

Sada skrutkovačov 1000V



kód	popis		
225248	+ skúšačka • 7 dielna, 1000V PH 0x75; 1x100; 2x100 mm PL 6.5x150; 5.5x125; 4x100 mm	20	1,000

Sada náradia, 1000V

PROFI
náradie



kód	popis		
239562	13 dielna / Elektrické izolované špeciálne náradie, do 1000 V	1	0,875
	1 2x6.5x100; 1x5.5x100; 0.8x4x100; 0.5x3x100; PH2x100; PH1x80; PZ2x100; PZ1x80; T20x100; T15x100; T10x100; + jednopólová skúšačka napätia		

Sada skrutkovačov 1000V



kód	popis		
2250133	6 dielna PH 0x75; 1x80; 2x100 mm PL 3x75; 4x100; 5x125 mm	1	0,525
2250298	7 dielna, VDE, Cr-V PL 0.5x3.0x75; 0.8x4.0x100; 1.0x5.5x125; 1.2x6.5x150 mm PH 0x75; PH1x80; PH2x100 mm	1	0,625

Sada skrutkovačov 1000V



kód	popis		
2250002	elektrikárska • 6 dielna, 1000V PH 4.5x80; 6x100 mm PL 3x100; 4x100; 5.5x125	30	0,400

Sada skrutkovačov 1000V



kód	popis		
2250003	+ skúšačka • 11 dielna /1000V PH 2x38; 0x60; 1x80; 2x100 3x150 mm PL 6x38; 3x100; 5.5x150 6.5x150; 8x175 mm	10	1,400

Skrutkovač plochý



kód	popis		
225426	3,5x075 mm	10	0,060
225031	4,0x100 mm	10	0,070
225215	5,5x100 mm	10	0,080
225216	6,5x100 mm	10	0,100
225217	6,5x125 mm	10	0,150
225218	6,5x150 mm	10	0,120
225219	8,0x150 mm	10	0,170
225220	8,0x200 mm	10	0,190

Skrutkovač krížový



kód	popis		
225158	PH0 3x060 mm	10	0,060
225133	PH0 3x075 mm	10	0,060
225015	PH1 4x075 mm	10	0,120
225201	PH1 5x100 mm	10	0,080
225018	PH2 6x100 mm	10	0,100
225019	PH2 6x125 mm	10	0,110
225020	PH2 6x150 mm	10	0,120
225021	PH3 8x150 mm	10	0,170

Skrutkovač Pozidriv



kód	popis		
225427	PZ 3,0x075 mm	10	
225138	PZ 4,0x075 mm	10	0,120
225139	PZ 5,0x100 mm	10	0,080
225063	PZ 6,0x100 mm	10	0,100
225065	PZ 6,0x150 mm	10	0,120
225251	PZ 8,0x200 mm	10	0,190

Skrutkovač elektrikársky 1000V, plochý



kód	popis		
225202	2,5x075 mm	10	0,056
225085	3,5x075 mm	10	0,060
225654	4,0x100 mm	10	0,068
225656	5,5x125 mm	10	0,100
225180	6,5x150 mm	10	0,130

Skrutkovač elektrikársky 1000V, krížový



kód	popis		
225768	PH0x075 mm	10	0,060
225346	PH2x100 mm	10	0,110

Skrutkovač plochý



kód	popis		
2250106	3,5x075 mm	10	0,028
2250107	4,0x100 mm	10	0,044
2250108	5,5x075 mm	10	0,044
2250109	5,5x100 mm	10	0,052
2250110	6,5x100 mm	10	0,070
2250111	6,5x125 mm	10	0,080
2250112	6,5x150 mm	10	0,090
2250113	8,0x150 mm	10	0,150
2250114	8,0x200 mm	10	0,160

Skrutkovač krížový



kód	popis		
2250102	PH0 3,0x075 mm	10	0,044
2250103	PH1 4,0x075 mm	10	0,044
2250101	PH1 5,0x075 mm	10	0,044
2250104	PH1 4,5x080 mm	10	0,048
2250098	PH1 5,0x100 mm	10	0,044
2250096	PH2 6,0x100 mm	10	0,070
2250097	PH2 6,0x125 mm	10	0,080
2250105	PH2 6,0x150 mm	10	0,090
2250100	PH3 8,0x150 mm	10	0,150

Skrutkovač Strike, plochý



kód	popis		
2250006	5x100 mm	12	0,100
2250007	6x100 mm	12	0,150
2250008	8x200 mm	12	0,260

Skrutkovač Strike, krížový



kód	popis		
2250009	PH 1x100 mm	12	0,100
2250010	PH 2x100 mm	12	0,150
2250011	PH 3x150 mm	10	0,230

Skrutkovač Strike, Pozidriv



kód	popis		
2250013	PZ 1x100 mm	12	0,100
2250014	PZ 2x100 mm	12	0,150
2250015	PZ 3x100 mm	10	0,150

Skúšačka



kód	popis		
213014	tester 100-250 V	24	0,067

Skrutkovač plochý



kód	popis		
2250154	3x075 mm	12	0,048
2250155	3x100 mm	12	0,051
2250156	3x150 mm	12	0,053
2250157	4x100 mm	12	0,055
2250158	5x075 mm	12	0,070
2250159	5x100 mm	12	0,074
2250160	5x125 mm	12	0,076
2250161	5x150 mm	12	0,081
2250163	6x100 mm	12	0,102
2250164	6x125 mm	12	0,108
2250165	6x150 mm	12	0,113
2250166	6x200 mm	12	0,125
2250167	8x150 mm	12	0,160

Skrutkovač krížový



kód	popis		
2250170	PH0 3x075 mm	12	0,048
2250171	PH0 3x100 mm	12	0,051
2250172	PH0 3x150 mm	12	0,053
2250173	PH1 5x075 mm	12	0,070
2250174	PH15x100 mm	12	0,074
2250175	PH1 5x125 mm	12	0,076
2250176	PH1 5x150 mm	12	0,081
2250177	PH2 6x100 mm	12	0,102
2250179	PH2 6x125 mm	12	0,108
2250180	PH2 6x150 mm	12	0,113
2250181	PH3 8x150 mm	12	0,160

Skrutkovač Pozidriv



kód	popis		
2250184	PZ0 3x075 mm	12	0,048
2250185	PZ1 5x100 mm	12	0,074
2250186	PZ2 6x100 mm	12	0,102
2250187	PZ3 8x150 mm	12	0,160

Skrutkovač mini



kód	popis		
2250182	PH1 5x038 mm, krížový	12	0,041
2250183	PH2 6x038 mm, krížový	12	0,042
2250168	PL 5x038 mm, plochý	12	0,041
2250169	PL 6x038 mm, plochý	12	0,042

Skrutkovač s bitmi PH/PL



kód	popis		
225653	bit (-) 5-6-7 (+) 1-2-3 magnetická anténka	1	0,100

SADY BITOV / BIT SETS

Sada bitov

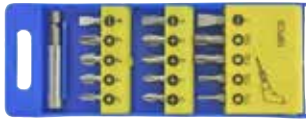

kód	popis		
226166	16 dielna PL 5, 6, 7; PH 0, 1, 2, 3; T10, T20, T30, T40; PZ 0, 1, 2, 3	20	0,180

Sada bitov



kód	popis		
225955	6 dielna PL 5,7; PH 1,2; PZ 1,2	1	0,400

Sada bitov, v púzdre



kód	popis		
212766	A) 11 dielna, 2xPH, 2xPL, 6xSL 1x imbus s nástavcom	1	0,133
2250137	B) 7 dielna, Cr-V, 4xPH, 2xPL 1x držiak magnetický	1	0,140

Sada hodinárskych skrutkovačov



kód	popis		
225388	11 dielna 3xPH; 2x priebojník; 6xPL 1,1,2, 1,8, 2, 2,4, 3 mm	1	0,250

Sada na opravu mobilov



kód	popis		
226589	36 dielna Hex: 2,5 mm, 3,0 mm, 3,5 mm, 4,0 mm, 4,5 mm, 5,0 mm, 5,5 mm / Phillips: PH2 / Torx: T3, T4, T5, T6, T7 / Hexagon: H0,9, H1,5, H2,0, H3,0 / Phillips: + 1,2, 1,5, 2,0, 3,0 / S drážkou: - 1,5, -2,0 / Pentalobe: 0,8 1,2 / Δ: Δ 2,3 / Y: Y2,0 / U: U2,6 BST-886 skrutkovače: 0,8, 1,5	1	

Sada bitov



kód	popis		
2250135	A) 12 dielna, Cr-V / PH	1	0,155
2250134	B) 24 dielna, Cr-V / PH	1	0,140

Sada bitov

Trieda ocele S2

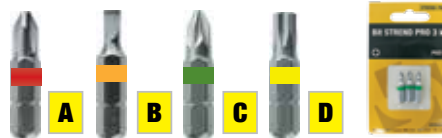

kód	popis		
2250244	A) krížový, PH00	3	0,025
2250245	A) krížový, PH01	3	0,025
2250246	A) krížový, PH02	3	0,025
2250247	A) krížový, PH03	3	0,025
2250240	B) plochý, 0.5x3 mm	3	0,025
2250241	B) plochý, 0.6x4 mm	3	0,025
2250242	B) plochý, 0.8x5 mm	3	0,025
2250243	B) plochý, 1.0x6 mm	3	0,025
2250248	C) pozidriv, PZ00	3	0,025
2250249	C) pozidriv, PZ01	3	0,025
2250250	C) pozidriv, PZ02	3	0,025
2250251	C) pozidriv, PZ03	3	0,025
2250252	D) torx, TX10	3	0,025
2250253	D) torx, TX15	3	0,025
2250254	D) torx, TX20	3	0,025
2250255	D) torx, TX25	3	0,025
2250256	D) torx, TX30	3	0,025
2250257	D) torx, TX40	3	0,025

Sada bitov

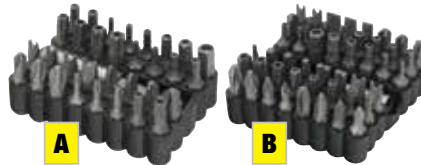

kód	popis		
239401	A) 33 dielna, Cr-v 1-60mm magnetický bit; 32-25mm Cr-V bity; Hex bity s otvorom: 2 2.5 3 4 5 6 1/8 3/32 5/32 5/64 7/64 9/64; Tri-wing: 1-2-3-4; Torque: 08/06/10; Kľúč: 4-6-8-10; Torx: 8-10-15-20-25-27-30-35-40	1	0,250
239402	B) 49 dielna, Cr-V 1-60mm magnetický bit; 48-25mm Cr-V bity; SL: 5-6-7mm PH:0-1-2-3 / PZ:0-1-2-3 / Square:1-2-3 / Spojka:2-3 / Torx bity s otvorom: T8-T10-T15-T20-T25-T27-T30-T35-T40 / Kľúč:4-6-8-10 / Tri-wing:1-2-3-4 / Torque:6-8-10 / Hex bity s otvorom: 2-2.5-3-4-5-6-1/8-3/32-5/32-5/64-7/64-9/64	1	0,333

Sada hlavíc



kód	popis		
232467	27 dielna, bity, hlavice, Cr-v 1-60mm magnetický bit / 1-50mm ADP / 9ks nástrčný bit: 5-6-7-8-9-10-11-12-13mm / 16-25mm CR-V bit, SL: 5-7mm; PH: 1-2-3; PZ: 1-2-3; Torx: T10-T15-T20-T25-T30; Hex: 4-5-6mm	1	0,333

Sada bitov

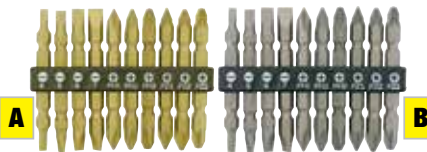

kód	popis		
2250297	A) 10 dielna, Bit 65 mm, Cr-V	1	0,208
2250136	B) 10 dielna, Bit 65 mm, Cr-V	1	0,208

PL 4, 5, 6, 7; PH 1, 2, 3; PZ 1, 2, 3

Sada bitov

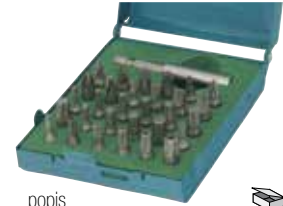

kód	popis		
2250138	31 dielna, Cr-V 31ks sada bitov · CR-V hrot · Veľkosti: SL3-4-5-6; PH0-1-2-3; PZ0-1-2-3; Torx: T10-T15-T20-T25-T27-T30-T40 · 1ks magnetický držiak bitov: 60 mm	1	0,375

Sada bitov



kód	popis		
2250130	45 dielna 21xPH; 12xPL; 11xSL; 8xTX; 1x držiak	1	0,600

Sada bitov



kód	popis		
2250118	40 dielna, bity + nástavec 12xPH; 3xPZ; 10xSL; 4xPL; 9xTX; 1x nástavec, 1x držiak	1	0,540

Sada bitov a vrtákov



kód	popis		
2250119	15 dielna, bity + vrtáky 4xPL; 4xPH; 5xHSS vrtáky s 1"4" stopkou 1.5, 2, 2.5, 3, 3.2 mm 1x rýchlopínací držiak; 2x držiak na bity	1	0,542

Sada bitov



kód	popis		
2250291	64 dielna, Bit, Cr-V 48ks - 25mm bity: PH 0, 1, 2x5ks, 3; Hex 1.5, 2, 2.5, 3, 4, 5.5, 6mm; PL 3, 4, 4.5, 5, 5.5, 6, 6.5, 7mm; TX 9, 10, 15, 20, 25, 27, 30, 40; PZ 0, 1, 2x5ks, 3; T 9, 10, 15, 20, 25, 27, 30, 40 / 15ks - 50mm bity: PH 1, 2x2ks, 3; PZ 1, 2x2ks, 3; PL 3, 5, 7mm; Torx 10, 15, 20, 25; 1ks - 52mm rýchlopínací držiak	1	0,850

Sada bitov so skrutkovačom

PROFI náradie



kód	popis	obal	kg
2250270	12-in-1, 12x bity (25mm)	1	0,283

1ks Skrutkovač račňový; 12ks Bitov (6.35X25mm): PL 4mm, 5mm, 6mm, 7mm / PH0, PH1, PH2, PH3 / T10, T15 / H2, H3

Sada bitov so skrutkovačom

PROFI náradie



kód	popis	obal	kg
2250272	14-in-1, 1x nástavec, 12x bity	1	0,338

1ks Skrutkovač račňový 5 polohový; 1ks nástavec bitov (60mm); 12ks bitov (6,35x25mm): PL 5mm, 6mm, 7mm / PH1, PH2, PH3 / T10, T15, T20H4, H5, H6

Sada bitov so skrutkovačom

PROFI náradie



kód	popis	obal	kg
2250273	11dielna, 10x bit (6.35x25mm)	1	0,333

1ks Skrutkovač račňový; 10ks Bitov (6,35x25mm): PL 3mm, 4mm, 5mm, 6mm / PH0, PH1, PH2, PH3 / T15, T20

Sada náradia

PROFI náradie



kód	popis	obal	kg
239482	41 dielna, račňový skrut. a bity	1	0,729

1ks skrutkovač račňový; 1ks nástavec bitov; 1ks magnetický držiak; 32ks bitov (6,35x25mm): PL 3, 4, 4, 5, 5, 6, 7 mm / PH 0, 1, 1, 2, 2, 3 / PZ 0, 1, 2, 3 / T 10, 15, 20, 25, 27, 30, 40 / H 3, 4, 5, 6 / S 0, 1, 2, 3; 6ks hlavíc 1/4": 5, 6, 7, 8, 9, 10 mm

Sada bitov so skrutkovačom



kód	popis	obal	kg
2250283	30 dielna, S2	20	0,450

28-25mm S2 bity s farebným krúžkom SL:4-5-6mm; PH:0-1-2-3; PZ:0-1-2-3; Torx: T10-T15-T20-T25-T27-T30-T40; Torx s otvorom: T10-T15-T20-T25-T27-T30-T40; Hex: 3-4-5-6mm; 1ks držiak na bity s rukoväťov; 1ks adaptér na bity

Sada náradia

PROFI náradie



kód	popis	obal	kg
239480	39 dielna	24	0,791

24x bity (6,35x25mm); 10x 1/4" hlavice; 2x nástavec 55, 100 mm; 1x univerzálny nástavec; 1x račňa; 1x skrutkovač

Sada náradia so skrutkovačom

PROFI náradie



kód	popis	obal	kg
239483	37 dielna, bity a hlavice	1	0,525

1ks Skrutkovač račňový; 1ks nástavec bitov (25mm); 26ks Bitov (6,35x25mm): PL 3mm, 4mm, 5mm, 6mm, 7mm / PH0, PH1, PH2, PH3 / T10, T15, T20, T25, T27, T30 / H3, H4, H5 / PZ0, PZ1, PZ2, PZ3 / S0, S1, S2, S3; 9ks 1/4" hlavíc: 4mm, 5mm, 6mm, 7mm, 8mm, 9mm, 10mm, 11mm, 12mm

Sada náradia



kód	popis	obal	kg
239481	30 dielna, 21x bity a 7x hlavice	24	0,417

1ks skrutkovač račňový; 21ks Bitov (6.35X25mm): PL 3mm, 4mm, 5mm, 6mm / PH0, PH1, PH2, PH3 / PZ0, PZ1, PZ2, PZ3 / T10, T15, T20, T25, T30 / H3, H4, H5, H6; 1ks Nástavec; 7ks 25.5 mm hlavíc: 5.5mm, 6mm, 7mm, 8mm, 9mm, 10mm, 11mm

Sada bitov, 7 dielna, S2



kód	popis	obal	kg
2250285	PL: 4,6 PH: 1,2,3 PZ: 1,2	60	0,066
2250286	PL: 3,4,5,6 PH: 1,2,3	60	0,066
2250287	PH: 0,1,2,3 PZ: 1,2,3	60	0,066
2250288	T: 10,15,20,25 TH: 4,5,6	60	0,066
2250289	T: 10,15,20,25,27,30,40	60	0,066
2250290	TH: 10,15,20,25,27,30,40	60	0,066

Sada náradia



kód	popis	obal	kg
239403	42 dielna, Cr-V	1	0,850

1x račňa s T rukoväťou so 100 mm hlavicoým adaptérom
1x175 mm flexibilný nástavec; 9x hlavice 5-13 mm;
31x bity 25mm - 5xSL 3,4,5,6,7 / 6xPH 1,2,3x2ks / 6xPZ 1,2,3x2ks / 7xTX 10,15,20,25,27,30,40 / 6xSL 2, 2.5, 3, 4, 5, 6

Sada bitov so skrutkovačom



kód	popis	obal	kg
2250294	44 dielna, Bit, Cr-V	1	0,550

1ks prehľadná račňová rukoväť / 1ks 60mm magnetický držiak bitov / 12ks 25mm Cr-V bity v rukoväti račne: PL 4,5,6; PH 1,2; PZ 1,2; TX 15,20; HX 4,5,6 / 20ks 25mm Cr-V bitov: PL 3,4,5,6; PH 0,1,2,3; PZ 0,1,2,3; TX 10,15,20,25; HX 3,4,5,6 / 10ks 50mm Cr-V bitov: PL 4,6; PH 1,2; PZ 1,2; TX 10,15,20,25

Sada náradia so skrutkovačom



kód	popis	obal	kg
239486	62 dielna, Bit, hlavice	1	0,600

1ks prehľadná račňová rukoväť / Bity: Torx: T10-T15-T20-T25-T30-T40; Hex:2-3-4-5-6; PZ: 0-1-1-2-2-3; Square: 0-1-1-2-2-3; PL: 2-3-4-5-6-7mm; PH: 0-1-1-2-2-31 / 60mm Bity SL:4-5-6; Hex:4-5-6; PH:1-2; PZ:1-2; Torx:T15-T20 / 12ks nástrčné hlavice: 4,5,6,8,10,12mm; 3/16, 1/4, 5/16, 3/8, 7/16, 1/2

BIT SETS AND TOOLS

Sada bitov a hlavic s mag. držiakom



kód	popis		
2250280	34 dielna, Bit 25mm, S2, Cr-V	1	0,510

24x bit 25mm, S2: PH: 1,1,2,2,3,3 PZ: 1,1,2,2,3,3
SL: 3,4,5,5,5,6,5,6,6 T: 10,15, 20, 25, 27, 30
8x hlavica, Cr-V: 5,6,7,8,9,10,11,12 mm
1x 75mm držiak na bity / 1x mag. adaptér na bity

Sada bitov s mag. držiakom

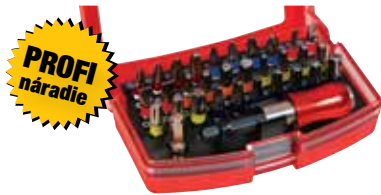

kód	popis		
2250279	32 dielna, Bit 25mm, S2	1	0,333

30x bit 25mm: PH: 1,2,2,3 PZ: 1,2,2,3 SL: 3,4,5,6
H: 3,4,5,6 T: 10,15,20,25,27,30,40
T s otvorom: 10,15,20,25,27,30,40
1x 25mm AD / 1x mag. adaptér na bity

Sada bitov s mag. držiakom



kód	popis		
2250292	44 dielna, Bit, S2	1	0,350

PL 3,4,5,6,7,8 mm; PH 0,1,2,3 mm; PZ 0,1,2,3 mm;
SP 4,6,8,10 mm; TX 8,10,15,20,25,27,30,40 mm;
HX 2,3,4,5,6 mm

Sada bitov



kód	popis		
2250282	41 dielna, Bit 25mm, S2	1	0,500

40x bit 25mm: PH: 0,0,1,1,2,2,3,3 PZ: 0,0,1,1,2,2,3,3
H: 3,4,5,6 H s otvorom: 3,4,5,6 T: 10,15,20,25,30,40
T s otvorom: 10,15,20,25,30,40
SL: 3,4,5,6 / 1x mag. adaptér na bity

Sada bitov s mag. držiakom



kód	popis		
2250284	15 dielna, S2	40	0,213

1ks držiak na bity; 14-25mm S2 bity s farebným krúžkom
SL: 5-6mm / PH: 1-2-3 / PZ: 1-2-3 / Torx: T10-T15-T20-T25-T30-T40

Sada bitov



kód	popis		
2250274	21 dielna, Bit 25mm, Cr-V	1	0,192

20x bit SL: 4,5,6 PH: 0,1,2,3 H: 3,4,5 PZ: 0,1,2,3
T: 10,15,20,25,27,30; 1x mag. adaptér 60 mm

Sada bitov



kód	popis		
2250275	15 dielna, Bit 25/50mm, S2	1	0,187

10x bit 25mm: PH: 1,2,3 PZ: 1,2,3 T: 10,20,25,30
5x bit 50mm: PZ: 1,2 PH: 1,2,3

Sada bitov



kód	popis		
2250277	16 dielna, Bit 25mm, S2	1	0,158

16x bit 25mm: PH: 0,1,2,3 PZ: 0,1,2,3 SL: 3,4,5
T: 10,15,20,25,30

Sada bitov



kód	popis		
2250276	15 dielna, Bit 25mm, S2	1	0,183

14x bit 25mm: PH: 1,2,3 PZ: 1,2,3 SL: 3,4,5
T: 10,15,20,25,30 / 1x mag. adaptér na bity

Sada bitov



kód	popis		
2250278	20 dielna, Bit 25mm, S2	1	0,183

20x bit 25mm: PH: 0,1,2,3 PZ: 0,1,2,3 SL: 4,5,6
T: 10,15,20,25,30,40

Adaptér - Hex Stopka



kód	popis		
232464	1/2"	1	0,046
232465	3/8"	1	0,040
232466	1/4"	1	0,014

Sada bitov



kód	popis		
2250281	37 dielna, Bit 25mm, S2	1	0,367

35x bit 25mm: SL: 4,4,5,5,5,6,6,5,7 H: 3,4,5,6
PH: 1,2,2,2 PZ: 1,2,2,2,3 T: 10,15,20,25,27,30,40
T s otvorom: 10,15,20,25,27,30,40; 1x 25mm AD
1x 65mm mag. adaptér na bity

Držiak magnetický



kód	popis		
222358	60 mm	50	0,045

Držiak magnetický, nastaviteľný



kód	popis		
222394	60 mm	50	0,045

Držiak magnetický



kód	popis		
222391	80 mm, 1/4"	5	0,025
222392	120 mm, 1/4"	5	0,044
222393	150 mm, 1/4"	1	0,060

Hlavica s magnetom 1/4"



kód	popis		
232455	06 mm	5	0,190
232450	08 mm	5	0,070
232246	10 mm	5	0,080
232456	12 mm	5	0,100
232457	13 mm	5	0,180

Adaptér - Hexagonálny



kód	popis		
232471	1/4"	1	0,007

Bit na sadrokartón



kód	popis		
2250390	PH2x25 mm	2	

Nôž odlamovací



kód	popis		
222209	čepel 18 mm	12	0,119

Nôž odlamovací



kód	popis		
222208	čepel 18 mm	12	0,167

Nôž odlamovací



kód	popis		
222210	čepel 18 mm	12	0,140

Nôž odlamovací



kód	popis		
222582	čepel 9 mm	50	0,028

Nôž odlamovací, plastový



kód	popis		
222330	čepel 18 mm	12	0,190

Nôž odlamovací



kód	popis		
222378	čepel 18 mm	12	0,180

Nôž odlamovací



kód	popis		
222359	čepel 18 mm	24	0,075

Nôž odlamovací



kód	popis		
222939	čepel 18 mm	24	0,090

Nôž odlamovací, plastový



kód	popis		
222380	čepel 9 mm	60	0,014

Nôž odlamovací, plastový



kód	popis		
222374	čepel 18 mm	12	0,090

Nôž odlamovací, plastový



kód	popis		
222373	čepel 9 mm	12	0,056

Nôž odlamovací, plastový



kód	popis		
222375	čepel 25 mm	6	0,210

Nôž odlamovací, plastový



kód	popis		
222362	čepel 18 mm	12	0,190

Nôž delfín, ZnBody



kód	popis		
222020	čepel 19 mm	12	0,250

Nôž delfín, bezpečnostný

SCHVÁLENÉ DO PRIEMYSLU



kód	popis		
222120	čepel 19 mm, rukoväť potiahnutá mäkkou TPR gumou		

Nôž odlamovací, AluBody



kód	popis		
222617	čepel 9 mm	12	0,100

Nôž odlamovací, AluBody



kód	popis		
222222	čepel 9 mm	12	0,090

Nôž odlamovací, AluBody



kód	popis		
222223	čepel 18 mm	12	0,188

Nôž odlamovací



kód	popis		
222511	čepel 9 mm	1	

Nôž odlamovací



kód	popis		
212035	čepel 18 mm	1	

Čepel náhradná

NOVINKA



kód	popis		
222185	19x61x0,6 mm, bal. 10 ks		

Čepel náhradná, háčik

NOVINKA



kód	popis		
222610	čepel 18 mm		0,064

Čepel náhradná



kód	popis		
222987	5x09 mm, bal. 10 ks	10	0,049
222695	5x18 mm, bal. 10 ks	10	0,049
222612	5x25 mm, bal. 10 ks	10	0,049

Čepel náhradná



kód	popis		
222983	19x61x0,6 mm	10	0,043

Nôž odlamovací, AluBody



kód	popis		
222806	čepel 22 mm	1	
222785	čepel 25 mm	1	

Nôž odlamovací, AluBody



kód	popis		
222807	čepel 18 mm	1	

Nôž odlamovací, AluBody



kód	popis		
222808	čepel 18 mm	1	

Nôž odlamovací, AluBody



kód	popis		
222810	čepel 18 mm	1	

Nôž odlamovací, AluBody

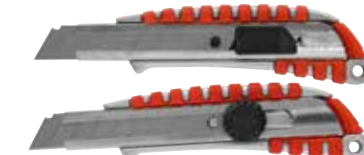

kód	popis		
222058	A) čepel 18 mm, s posúvnikom	12	0,104
222634	B) čepel 18 mm, s kolieskom	12	0,104

Nôž odlamovací, pvc



kód	popis		
222321	čepel 18 mm	1	

Škrabka maliarská



kód	popis		
222814	150 mm / rúčka 400 mm	1	0,291
2160736	Náhradná čepel 150 mm	10	0,069

Nôž odlamovací, sada



kód	popis		
222379	veľký 160 mm / malý 130 mm	12	0,076

Sada odlamovacích nožov



kód	popis		
212314	6 dielna	25	0,140

Nôž dielenský



kód	popis		
222760	čepel 2.0 mm, nerez	1	

Sada odlamovacích nožov



kód	popis		
222927	A) 24ks / čepel 18 mm	6	3,500
222926	B) 24ks / čepel 18 mm	6	3,500

Sada odlamovacích nožov



kód	popis		
222925	24ks / čepel 09 mm	6	2,040

Sada odlamovacích nožov



kód	popis		
217478	3 dielna v kufríku čepel 18 mm čepel 19 mm čepel 09 mm	1	0,685

Nôž na rezanie izolácie



kód	popis		
222819	280x1.5 mm, nerezová oceľ	1	0,180

Nôž na sklenenú vat



kód	popis		
222766	35 cm, 1.5 mm čepel, nerez	1	

Nôž na káble, krátky



kód	popis		
222765	čepel 2.0 mm, nerez	1	

Nôž na koberce



kód	popis		
217998	195 mm, nerezový	1	0,200

Nôž elektrikársky



kód	popis		
212169	A) rovný, 170 mm	24	0,150
212839	B) zahnutý, 170 mm	24	0,150

Nôž elektrikársky, káblový



kód	popis		
222372	08-28 mm	10	0,110

Nôž elektrikársky, káblový



kód	popis		
222999	08-28 mm	10	0,110

Sada skalpelov



kód	popis		
212317	17 dielna	10	0,170

Brašňa na náradie



kód	popis		
212853	400x200x300 mm	1	1,850

Textilná brašňa na náradie zatvárateľná so zipsom a ramenným popruhom.

Brašňa na náradie



kód	popis		
212273	370x270x420 mm	1	2,120

Textilná brašňa na náradie, s kovovou rúčkou a ramenným popruhom.

Brašňa na náradie



kód	popis		
212781	470x295x250 mm	15	1,470

Textilná brašňa na náradie zatvárateľná so zipsom a ramenným popruhom.

Brašňa na náradie



kód	popis		
212640	410x200x260 mm	6	1,420

Textilná brašňa na náradie, s kovovou rúčkou a ramenným popruhom.

Opasok na náradie



kód	popis		
212136	360x155 mm	50	0,160

Brašňa na náradie



kód	popis		
212165	410x225x222 mm	1	1,417

Textilná brašňa na náradie, s plastovou rúčkou a ramenným popruhom.

Opasok na náradie



kód	popis		
212135	300x380 mm	30	0,480

Púzdro na náradie



kód	popis		
212133	385x280 mm	50	0,430

Opasok na náradie



kód	popis		
212128	TAPEHOLDER	50	0,610

Opasok na náradie



kód	popis		
212125	A) TAPEHOLDER	10	0,360
212211	B) TAPEHOLDER, 340x250 mm	1	0,210

Opasok na náradie



kód	popis		
212854	1150x900x100 mm	1	1,050

Opasok na náradie



kód	popis		
212176	550x360 mm	1	0,463

Opasok na náradie



kód	popis		
212150	950x75 mm	1	0,118

Púzdro na opasok



kód	popis		
212158	A) 240x165 mm	1	0,075
212163	B) 245x165 mm	1	0,120

Púzdro na opasok



kód	popis		
212160	305x155 mm	1	0,175

Púzdro na opasok



kód	popis		
212148	A) na opasok	1	0,118
212215	B) 95x125 mm	10	0,088

Stojan na krabice - zásobník

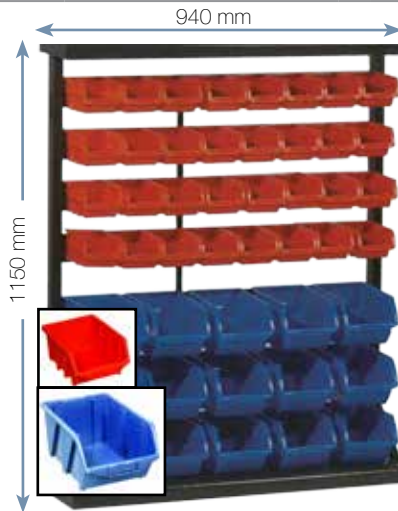

kód	popis		
239382	1150x940mm, konštrukcia kovová 32 malých a 15 veľkých krabíc	2	24

Stojan na krabice - zásobník



kód	popis		
239383	1500x940mm, konštrukcia kovová 28 extra veľkých krabíc	1	36

Plastový box na spojovací materiál



kód	popis		
239436	060x080x115 mm	36	
239274	070x100x155 mm	33	
239438	090x120x195 mm	28	
239341	120x160x230 mm	16	
239231	150x200x290 mm	15	
239437	180x240x390 mm	10	

Organizér zásuvkový



kód	popis		
239181	44 zásuviek/500x160x390 mm	4	3,250

Organizér



kód	popis		
239360	24 zásuviek/500x160x390 mm	4	3,250

Organizér zásuvkový



kód	popis		
239233	30 zásuviek/500x160x230 mm	4	2,250

Organizér



kód	popis		
239370	40 zásuviek/500x160x250 mm	4	2,250

Drevený pracovný stôl



kód	popis		
2170709	L1640xW500xH820 mm Stôl: L1520xW500mm Hrúbka tabuľky: 18mm Noha: 60x60mm Materiál: drevo	1	48,000

Brašňa montérska



kód	popis		
212827	kožená, 400x260x100 mm	1	0,500

Brašňa elektrikárska



kód	popis		
212855	kožená, 310x220x150 mm	1	0,500

Organizér zásuvkový



kód	popis		
239122	A) 12 zásuviek/265x160x235 mm	8	1,180
239312	B) 6 zásuviek / 265x160x235mm	1	1,180

BOXY NA NÁRADIE A ORGANIZÉRY

Box na náradie, nerezový

Nerez



kód	popis		
239040	57x35x83 cm, s kolieskami	1	16,000

Organizér kufrikový, plastový



kód	popis		
239440	06x / 380x340x110 mm / 23kg	8	1,750

Kufor na náradie, plechový



kód	popis		
239189	430x200x160 mm, 3 dielny	6	3,330
239156	430x200x200 mm, 5 dielny	4	4,250
239435	530x200x160 mm, 3 dielny	6	1,000
239434	530x200x200 mm, 5 dielny	4	1,000

Kufor na náradie, hliníkový



kód	popis		
113422	450x330x150 mm	5	2,700

Box na náradie, plastový



kód	popis		
239232	66x30x32 cm, s kolieskami	4	4,250

Box na náradie, plastový



kód	popis		
239176	Sada, 3 dielna - 54, 45, 40 cm	8	2,500

Box na náradie, plastový



kód	popis		
239254	500x240 mm, max. 12 kg	6	2,000

Box na náradie, plastový



kód	popis		
239223	560x320x290 mm, max. 20 kg	4	3,130

Box na náradie "Roller", plastový



kód	popis		
239094	na kolieskach, 45x26x62 cm	2	6,000

Organizér kufrikový, plastový



kód	popis		
239443	09x / 460x170x95 mm / 9kg	24	0,583

Organizer, plastový



kód	popis		
239154	385x350 mm 30 zásuviek, max. 12 kg	8	2,125

Organizer, plastový



kód	popis		
239145	405x305x65 mm 36 zásuviek, max. 25 kg	8	2,000

TOOL BOXES AND ORGANIZERS

Box na náradie, plastový



Hliník

kód	popis		
239444	45,8x24,5x25,7 cm	1	
239445	55,0x27,7x26,7 cm	1	
239446	59,8x32,7x28,6 cm	1	

Box na náradie, plastový



Hliník

kód	popis		
239447	45,8x22,7x25,7 cm	1	

Box na náradie, plastový



Hliník

kód	popis		
239448	55,0x27,7x26,7 cm	1	

Box na náradie, plastový



Hliník

kód	popis		
239449	59,8x32,7x28,6 cm	1	

Box na náradie, plastový



kód	popis		
239211	398x200x186 mm	6	
239253	458x257x227 mm	6	1,330
239153	550x257x227 mm	2	1,500

Organizér kufrikový, plastový



kód	popis		
239454	390x290x130 mm	1	
239455	490x390x130 mm	1	

Organizér kufrikový, plastový



kód	popis		
239450	350x155x195 mm	1	
239451	350x195x290 mm	1	

Organizér kufrikový, plastový

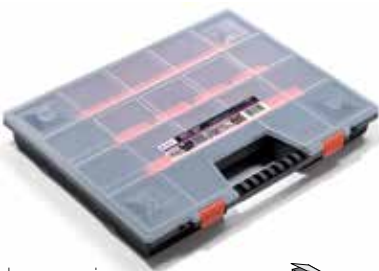

kód	popis		
239452	650x290x390 mm	1	
239453	490x390x650 mm	1	

Organizér kufrikový, plastový



kód	popis		
239457	85x150x245 mm	1	

Organizér kufrikový, plastový



kód	popis		
239459	85x238x359 mm	1	
239460	85x298x400 mm	1	

Organizér kufrikový, plastový



kód	popis		
239456	45x117x198 mm	1	

Box a veko na box, plastový



kód	popis		
239461	A) 300x200x160 mm	1	
239462	A) 400x300x200 mm	1	
239463	A) 600x400x260 mm	1	
239464	B) 300x200x020 mm	1	
239465	B) 400x300x030 mm	1	
239466	B) 600x400x035 mm	1	

Organizér kufrikový, plastový



kód	popis		
239442	15x / 315x255x55 mm / 7kg	20	0,550
239441	21x / 380x315x60 mm / 12.5kg	20	0,850

Palica gumová, rúčka kovová s TPR



kód	popis		
230191	450 g, 31.5 cm	36	0,560
230192	680 g, 33 cm	40	0,830
230193	900 g, 36 cm	25	1,040

Palica gumová, rúčka drevená



kód	popis		
230310	340 g, 31 cm		0,380
230112	450 g, 33 cm	40	0,540
230002	680 g, 36 cm	24	0,830
230058	900 g, 36 cm	25	1,080

Palica gumová, rúčka kovová s TPR



kód	popis		
230137	340 g, 30 cm	60	0,544
230138	450 g, 32.5 cm	50	0,694
230139	680 g, 34 cm	30	0,917
230140	900 g, 34 cm	25	1,250

Palica gumová, B/W, kovová s TPR



kód	popis		
230224	450 g, 36 cm	36	0,720
230225	680 g, 36 cm	6	0,950
230226	900 g, 36 cm	6	1,250

Palica gumová, B/W, rúčka drevená



kód	popis		
230260	340 g, 33 cm	36	0,700
230261	450 g, 30 cm	6	0,555
230262	560 g, 35 cm	36	0,750
230263	680 g, 32 cm	36	1,000
230264	910 g, 38 cm	6	1,166

Palica drevená



kód	popis		
221392	12x29 cm	12	2,990

Palica gumová



VysokoKvalitná
100% GUMA

kód	popis		
230351	340 g, 31 cm, drevená rúčka	1	0,380
230352	450 g, 33 cm, drevená rúčka	1	0,540
230353	680 g, 36 cm, drevená rúčka	1	0,830
230354	900 g, 36 cm, drevená rúčka	1	1,080

Palica gumová, rúčka drevená



kód	popis		
230141	340 g, 29.5 cm	60	0,400
230182	450 g, 29.5 cm	50	0,542
230142	680 g, 33 cm	30	0,833
230143	900 g, 35 cm	6	1,220

Palica gumová, rúčka kovová s TPR



kód	popis		
230214	340 g, 29 cm	50	0,420
230287	450 g, 34 cm	45	0,520
230215	680 g, 34 cm	30	0,760
230216	900 g, 36.5 cm	25	1,050

Palica silikónová, rúčka kovová s TPR



kód	popis		
230220	35 mm, 29.5 cm	48	0,458
230245	náhradná hlava silikón, žltá	1	
230247	náhradná hlava guma, čierna	1	

Palica silikónová, rúčka kovová s TPR



kód	popis		
230060	40 mm, 29.5 cm	48	0,480
230245	náhradná hlava silikón, žltá	1	

Palica sklolaminátová s TPR



kód	popis		
230222	3000 g, 80 cm	6	4,000
230163	4000 g, 85 cm	4	5,250
230164	5000 g, 93 cm	4	6,000
230165	6000 g, 92 cm	4	7,000
230249	8000 g, 90 cm	2	9,250

Palica



ergonomická drevená rukoväť
vyrobená s kmeňa stromu Hickory.
Hickory WOOD

**PROFI
náradie**

kód	popis		
230342	1000 g, 25.5 cm	1	1,260
230343	1500 g, 28 cm	1	1,700
230344	2000 g, 30 cm	1	2,290

Palica s drevenou rúčkou



kód	popis		
230300	1000 g	1	1,260
230301	1500 g	1	1,700
230302	2000 g	1	2,290

Palica s drevenou rúčkou



kód	popis		
230205	1000 g, 26.5 cm	12	1,120
230085	1250 g, 25 cm	1	1,500
230206	1500 g, 27.5 cm	12	1,750
230207	2000 g, 30 cm	6	2,290
230208	3000 g, 60 cm	6	3,830
230209	4000 g, 70 cm	4	5,000
230210	5000 g, 80 cm	4	5,780
230211	6000 g, 90 cm	4	7,250
230212	8000 g, 90 cm	2	9,500
230266	10000 g, 89.5 cm	2	11,000

Kladivo s drevenou rúčkou



kód	popis		
230111	3000 g, 80 cm	6	4,000
230213	4000 g, 90 cm	4	4,520
230100	5000 g, 80 cm	4	6,750
230061	6000 g, 80 cm	4	6,750
230062	8000 g, 90 cm	2	8,500
230014	10000 g, 90 cm	2	10,450

Palica sklolaminátová s TPR





kód	popis		
230161	1000 g, 25.5 cm	24	1,250
230162	1500 g, 30 cm	6	1,700
230221	2000 g, 30 cm	6	2,250

HAMMERS AND MALLETS

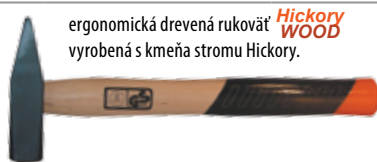
Kladivo zámočnicke





ergonomická drevená rukoväť *Hickory WOOD*
vyrobená s kmeňa stromu Hickory.

kód	popis		
230332	100g, 26 cm	1	0,170
230333	200g, 28 cm	1	0,291
230334	300g, 30 cm	1	0,480
230335	400g, 32 cm	1	0,520
230336	500g, 32 cm	1	0,580
230337	600g, 32,5 cm	1	0,720
230338	800g, 34,5 cm	1	0,960
230339	1000g, 36 cm	1	1,250
230340	1500g, 38 cm	1	1,790
230341	2000g, 40 cm	1	2,333



Kladivo zámočnicke, drevená rúčka



kód	popis		
230289	0100 g, 26 cm	1	0,171
230290	0200 g, 28 cm	1	0,286
230291	0300 g, 29 cm	1	0,400
230293	0400 g, 30 cm	1	0,533
230294	0500 g, 31 cm	1	0,644
230295	0600 g, 33 cm	1	0,756
230296	0800 g, 35 cm	1	0,924
230297	1000 g, 36 cm	1	1,176
230298	1500 g, 37 cm	1	1,764
230299	2000 g, 40 cm	1	2,352

Kladivo zámočnicke, drevená rúčka



kód	popis		
230131	0100 g, 26 cm	12	0,170
230133	0200 g, 28 cm	6	0,291
230134	0300 g, 29 cm	6	0,480
230149	0400 g, 30 cm	6	0,520
230132	0500 g, 31 cm	6	0,580
230135	0600 g, 32 cm	12	0,720
230150	0800 g, 35 cm	6	0,960
230151	1000 g, 36 cm	6	1,250
230152	1500 g, 37 cm	6	1,790
230153	2000 g, 39 cm	6	2,333



Kladivo sklaminátové s TPR



kód	popis		
230176	3000 g, 92 cm	1	12,00
230179	4000 g, 90 cm	6	5,100
230178	5000 g, 90 cm	6	5,330
230177	6000 g, 90 cm	6	7,000
230250	8000 g, 100 cm	1	9,500



Kladivo zámočnicke, rúčka kovová s TPR



kód	popis		
230118	0100 g, 27 cm	6	0,266
230120	0200 g, 29 cm	6	0,380
230119	0300 g, 30 cm	6	0,580
230122	0400 g, 31 cm	12	0,710
230121	0500 g, 33 cm	6	0,722
230123	0600 g, 33 cm	6	0,780
230125	0800 g, 36 cm	6	0,890
230124	1000 g, 36 cm	6	1,280
230126	1500 g, 40 cm	6	1,917
230127	2000 g, 39,5 cm	6	2,420
230128	3000 g, 79 cm	6	4,370

Kladivo zámočnicke, sklaminátové s TPR



kód	popis		
230167	0100 g, 26 cm	12	0,240
230168	0200 g, 28 cm	1	0,361
230171	0300 g, 30 cm	12	0,500
230170	0400 g, 31 cm	12	0,625
230169	0500 g, 34 cm	12	0,756
230172	0600 g, 34,5 cm	12	0,861
230195	0800 g, 36 cm	24	1,125
230173	1000 g, 35 cm	12	1,370
230175	1500 g, 38 cm	12	1,750
230174	2000 g, 40 cm	12	2,333

Kladivo murárske, rúčka kovová s TPR



kód	popis		
230189	600 g, 32 cm	36	0,046



Kladivo murárske, rúčka kovová s TPR



kód	popis		
230104	600 g, 32 cm	6	1,000



Kladivo murárske, s drevenou rúčkou



kód	popis		
230200	700 g / 43,5 cm	24	0,710



Kladivo obuvnicke, sklaminátové s TPR



kód	popis		
230198	450 g, 33,5 cm	12	0,722



Kladivo murárske



kód	popis		
230347	600 g, 33,5 cm, mäkká rúčka SOFT	1	



Kladivo tesárske



kód	popis		
230346	600 g, 34 cm, mäkká rúčka SOFT	1	

Kladivo obuvnicke



kód	popis		
230345	600 g, 34 cm, mäkká rúčka SOFT	1	

Kladivo fajrontové

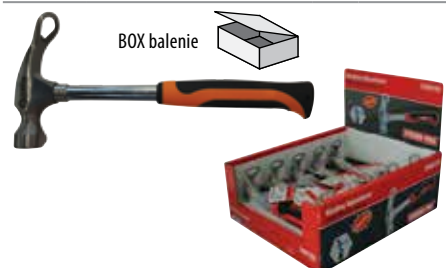

BOX balenie

kód	popis		
212586	600 g / s otvarákom, 22,5 cm	10	

Kladivo tesárske, sklaminátové



kód	popis		
230265	600 g, 34 cm	6	0,974

Kladivo tesárske, rúčka kovová s TPR



kód	popis		
230190	600 g, 32 cm	12	0,570

Kladivo tesárske, sklaminátové s TPR



kód	popis		
230160	600 g, 34 cm	6	0,966

Pilník plochý

PROFI **Filex**



kód	popis		
227435	150 mm, s2	5	
227564	200 mm, s2	5	
227437	250 mm, s2	5	
227438	300 mm, s2	5	
227565	350 mm, s2	5	

Pilník 3-hranný

PROFI **Filex**



kód	popis		
227577	150 mm, s2	5	
227578	200 mm, s2	5	
227451	250 mm, s2	5	

Pilník 4-hranný

PROFI **Filex**



kód	popis		
227570	150 mm, s2	5	
227571	200 mm, s2	5	
227446	250 mm, s2	5	
227572	300 mm, s2	5	

Pilník polkruhový

PROFI **Filex**



kód	popis		
227566	150 mm, s2	5	
227444	200 mm, s2	5	
227567	250 mm, s2	5	
227568	300 mm, s2	5	

Pilník kruhový

PROFI **Filex**



kód	popis		
227573	150 mm, s2	5	
227574	200 mm, s2	5	
227575	250 mm, s2	5	
227576	300 mm, s2	5	

Pilník na reťazové píly

PROFI **Filex**



kód	popis		
227517	200 mm, s3, 3.5 mm	3	
227518	200 mm, s3, 4.3 mm	3	
227520	200 mm, s3, 4.8 mm	3	
227519	200 mm, s3, 5.5 mm	3	

Pilník 4-hranný



kód	popis		
227447	150 mm, s2	10	0,110
227448	200 mm, s2	10	0,180
227449	250 mm, s2	10	0,150
227450	300 mm, s2	5	0,270

Pilník plochý



kód	popis		
227409	150 mm, s2	10	0,120
227412	200 mm, s2	10	0,280
227415	250 mm, s2	10	0,380
227418	300 mm, s2	10	0,500
227421	350 mm, s2	10	0,720

Pilník polkruhový



kód	popis		
227424	150 mm, s2	10	0,140
227427	200 mm, s2	10	0,250
227430	250 mm, s2	10	0,370
227433	300 mm, s2	10	0,440

Pilník kruhový



kód	popis		
227436	150 mm, s2	10	0,200
227439	200 mm, s2	10	0,170
227442	250 mm, s2	10	0,240
227445	300 mm, s2	10	0,340

Pilník 3-hranný



kód	popis		
227452	150 mm, s2	10	0,100
227455	200 mm, s2	50	0,200
227458	250 mm, s2	10	0,440
227461	300 mm, s2	50	0,360

Rašpľa plochá



kód	popis		
227463	200 mm	10	0,260
227464	250 mm	10	0,350

Rašpľa polkruhová



kód	popis		
227465	200 mm	10	0,250
227466	250 mm	10	0,270

Rašpľa kruhová



kód	popis		
227467	200 mm	10	0,180
227468	250 mm	10	0,260

Sada pilníkov



kód	popis		
227290	200 mm, 5 dielna v kufríku	1	1,500

1x kruhový, 1x úsečový, 1x trojuholníkový, 1x štvorcový, 1x plochý

Sada ihlových pilníkov



kód	popis		
227291	3x150 mm, 6 dielna	1	1,370

1x úsečový, 1x kruhový, 1x plochý, 1x štvorcový, 1x plochý, 1x trojuholníkový

227386	4x170 mm, 6 dielna	6	0,280
--------	--------------------	---	-------

1x úsečový, 1x kruhový, 1x plochý, 1x štvorcový, 1x plochý, 1x trojuholníkový

Sada rašplí



kód	popis		
227514	200 mm, 3 dielna v obale	20	0,750

1x úsečový, 1x kruhový, 1x plochý

Sada pilníkov



kód	popis		
227146	200 mm, 3 dielna v obale	5	3,230

1x úsečový, 1x kruhový, 1x plochý

Sada pilníkov



kód	popis		
227205	200 mm, 3 dielna	1	

1x úsečový, 1x kruhový, 1x plochý

Rukoväť na pilník, drevo, buk



kód	popis		
227482	080 mm	1	0,017
227483	090 mm	1	0,023
227484	100 mm	1	0,029
227485	110 mm	1	0,033
227486	120 mm	1	0,043
227487	130 mm	1	0,056
227488	140 mm	1	0,077
227489	150 mm	1	0,083

Huba KONNER S92 - AluOxide



kód	popis		
243470	100x70x25mm, G060	1	0,029
243471	100x70x25mm, G080	1	0,020
243472	100x70x25mm, G100	1	0,020
243473	100x70x25mm, G120	1	0,020
243474	100x70x25mm, G180	1	0,026
243475	100x70x25mm, G220	1	0,026



Brúsny papier Sandpap145



kód	popis		
243252	P036	50	1,900
243262	P040	50	1,700
243409	P046	50	0,030
243320	P060	50	1,083
243253	P080	50	1,150
243254	P100	50	0,950
243255	P120	50	0,850
243256	P150	50	0,800

Papier Sicpap 166

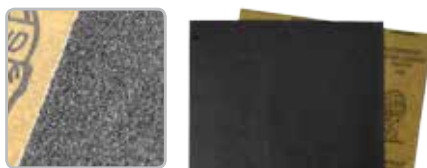

kód	popis		
243486	280/230mm, P060	50	0,036
243487	280/230mm, P080	50	0,031
243488	280/230mm, P100	60	0,027
243489	280/230mm, P120	50	0,022
243490	280/230mm, P150	50	0,020

Brúsne plátno KONER AluOxi



kód	popis		
243101	P036, 280/230 mm	50	0,085
243109	P040, 280/230 mm	50	0,068
243108	P046, 280/230 mm	50	0,058
243117	P060, 280/230 mm	50	0,056
243080	P080, 280/230 mm	50	0,054
243113	P100, 280/230 mm	50	0,046
243115	P120, 280/230 mm	50	0,044
243114	P150, 280/230 mm	50	0,042
243039	P180, 280/230 mm	50	
243528	P220, 280/230 mm	50	
243027	P240, 280/230 mm	50	
243529	P280, 280/230 mm	50	
243530	P320, 280/230 mm	50	
243031	P400, 280/230 mm	50	

Pás KONER R10 - AluOxide



kód	popis		
243460	150mm, L-50m, P040	1	6,000
243461	150mm, L-50m, P060	1	5,500
243462	150mm, L-50m, P080	1	4,250
243463	150mm, L-50m, P100	1	3,750
243464	150mm, L-50m, P120	1	3,750
243465	150mm, L-50m, P150	1	3,500
243466	150mm, L-50m, P180	1	3,000

Výsek KONNER



kód	popis		
243041	125 mm, P036, AluOxide	50	0,012
243177	125 mm, P040, AluOxide	50	0,010
243049	125 mm, P060, AluOxide	50	0,013
243476	125 mm, P080, AluOxide	50	0,012
243477	125 mm, P100, AluOxide	50	0,010
243478	125 mm, P120, AluOxide	50	0,009
243479	125 mm, P150, AluOxide	50	0,008

Vysek KONER D38, 8 dier

NOVINKA



kód	popis		
243048	125 mm, P040, 10ks	10	
243444	125 mm, P060, 10ks	10	
243453	125 mm, P080, 10ks	10	
243441	125 mm, P100, 10ks	10	
243395	125 mm, P120, 10ks	10	

Brúsny pás KONER SB53/SB45

NOVINKA



kód	popis		
2430006	75x457 mm, P040	3	
2430007	75x457 mm, P060	3	
2430008	75x457 mm, P080	3	
2430009	75x457 mm, P100	3	
2430010	75x457 mm, P120	3	
2430001	75x533 mm, P040	3	
2430002	75x533 mm, P060	3	
2430003	75x533 mm, P080	3	
2430004	75x533 mm, P100	3	
2430005	75x533 mm, P120	3	

Sada brúsnych papierov, 8 dier

NOVINKA



kód	popis		
2430016	93x230 mm, P040, 10ks	10	
2430017	93x230 mm, P060, 10ks	10	
2430018	93x230 mm, P080, 10ks	10	
2430020	93x230 mm, P120, 10ks	10	
2430011	115x230 mm, P040, 10ks	10	
2430012	115x230 mm, P060, 10ks	10	
2430013	115x230 mm, P080, 10ks	10	
2430014	115x230 mm, P100, 10ks	10	
2430015	115x230 mm, P120, 10ks	10	

Kotúč lamelový

NOVINKA

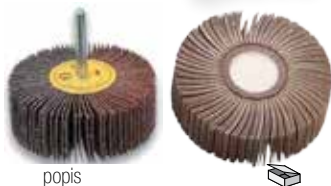

kód	popis	kg
243504	40x20 mm, P40	10
243503	40x20 mm, P60	10
243652	40x20 mm, P80	10
243197	60x30 mm, P40	10
243198	60x30 mm, P60	10
243199	60x30 mm, P80	10
243196	80x30 mm, P40	10
243194	80x30 mm, P60	10
243195	80x30 mm, P80	10

Kotúč biely, korund

TYROLIT



kód	popis	kg
223392	100x20x20 mm, A46	
223476	150x20x20 mm, A60	
223010	150x20x20 mm, A80	
223402	175x20x20 mm, A46	
223018	175x20x20 mm, A80	

Kotúč ružový, korund

TYROLIT



kód	popis	kg
223020	150x20x20 mm, A46	
223981	150x20x20 mm, A60	
223119	175x20x20 mm, A46	
223035	175x20x32 mm, A98	

Kotúč tmavý, korund

TYROLIT



kód	popis	kg
243460	150x20x20 mm, C60	
243461	150x20x20 mm, C240	
243462	175x20x20 mm, C80	
243463	175x20x20 mm, C240	

Kotúč vejarový, Zirkónový

NOVINKA



kód	popis	kg
2230476	115x22 mm, A040	10
2230477	115x22 mm, A060	10
2230478	115x22 mm, A080	10
2230479	115x22 mm, A100	10
2230480	115x22 mm, A120	10
2230487	125x22 mm, A040	10
2230488	125x22 mm, A060	10
2230489	125x22 mm, A080	10
2230490	125x22 mm, A100	10
2230492	125x22 mm, A120	10
2230493	150x22 mm, A040	10
2230494	150x22 mm, A060	10
2230499	150x22 mm, A080	10
2230500	150x22 mm, A100	10
2230503	150x22 mm, A120	10

Kotúč KONER, nylonový

NOVINKA



kód	popis	kg
243505	115 mm	1
243506	125 mm	1
243507	150 mm	1

Kotúč brusný na reťaz



kód	popis	kg
223180	145x3,2x22,3 mm	1
223027	145x6,0x22,3 mm	1
223452	145x4,7x22,3 mm	1

Brúsny kameň

TYROLIT



kód	popis	kg
223286	50x25x200 mm	1

Kotúč - AluOxide, vejárový



kód	popis	kg
2230116	D22, 115x22mm, A040	0,100
2230117	D22, 115x22mm, A060	0,065
2230118	D22, 115x22mm, A080	0,100
2230120	D22, 115x22mm, A100	0,100
2230121	D22, 115x22mm, A120	0,060
2230122	D22, 125x22mm, A040	0,110
2230123	D22, 125x22mm, A060	0,070
2230124	D22, 125x22mm, A080	0,070
2230125	D22, 125x22mm, A100	0,070
2230126	D22, 150x22mm, A040	0,130
2230127	D22, 150x22mm, A060	0,140
2230128	D22, 150x22mm, A080	0,140

Konner D22

Unášač brúsneho papiera



kód	popis	kg
222337	so stopkou / 125 mm	0,100

Unášač brúsneho papiera



kód	popis	kg
222443	s maticou / 115 mm	0,120
222336	s maticou / 125 mm	0,130

Unášač brúsneho papiera



kód	popis	kg
222312	115 M14, suchý zips, matica	0,130
222313	125 M14, suchý zips, matica	0,130

Unášač brúsneho papiera



kód	popis	kg
222315	115 M14, so stopkou 8mm	0,150
222317	125 M14, so stopkou 8mm	0,190

Vrták do betónu, 4-hrotový, S4



kód	priemer	pracovná dĺžka	celková dĺžka		
4200499	4,0 mm	50 mm	110 mm	1	0,034
4200500	5,0 mm	50 mm	110 mm	1	0,036
4200501	6,0 mm	50 mm	110 mm	1	0,038
4200502	6,0 mm	100 mm	160 mm	1	0,044
4200503	6,0 mm	150 mm	210 mm	1	0,060
4200504	6,0 mm	200 mm	260 mm	1	0,064
4200505	8,0 mm	50 mm	110 mm	1	0,046
4200506	8,0 mm	100 mm	160 mm	1	0,070
4200507	8,0 mm	150 mm	210 mm	1	0,100
4200508	8,0 mm	200 mm	260 mm	1	0,090
4200509	10,0 mm	100 mm	160 mm	1	0,058
4200510	10,0 mm	150 mm	210 mm	1	0,085
4200511	10,0 mm	200 mm	260 mm	1	0,100
4200512	10,0 mm	300 mm	350 mm	1	0,150
4200513	10,0 mm	400 mm	450 mm	1	0,180
4200514	10,0 mm	550 mm	600 mm	1	0,220
4200515	10,0 mm	950 mm	1000 mm	1	0,360
4200516	12,0 mm	50 mm	110 mm	1	0,100
4200517	12,0 mm	100 mm	160 mm	1	0,066
4200518	12,0 mm	150 mm	210 mm	1	0,100
4200519	12,0 mm	200 mm	260 mm	1	0,128
4200520	12,0 mm	300 mm	350 mm	1	0,100
4200521	12,0 mm	400 mm	450 mm	1	0,190
4200522	12,0 mm	550 mm	600 mm	1	0,300
4200523	12,0 mm	950 mm	1000 mm	1	0,400
4200524	14,0 mm	100 mm	160 mm	1	0,083
4200525	14,0 mm	200 mm	260 mm	1	0,160
4200526	14,0 mm	300 mm	350 mm	1	0,200
4200527	14,0 mm	400 mm	460 mm	1	0,280
4200528	14,0 mm	550 mm	600 mm	1	0,360
4200529	14,0 mm	950 mm	1000 mm	1	0,560
4200530	16,0 mm	100 mm	160 mm	1	0,100
4200531	16,0 mm	150 mm	210 mm	1	0,160
4200532	16,0 mm	200 mm	260 mm	1	0,190
4200533	16,0 mm	300 mm	350 mm	1	0,230
4200534	16,0 mm	400 mm	460 mm	1	0,340
4200535	16,0 mm	550 mm	600 mm	1	0,440
4200536	16,0 mm	950 mm	1000 mm	1	0,760
4200537	18,0 mm	200 mm	260 mm	1	0,240
4200538	18,0 mm	400 mm	450 mm	1	0,420
4200539	18,0 mm	550 mm	600 mm	1	0,600
4200540	18,0 mm	950 mm	1000 mm	1	0,880
4200541	20,0 mm	400 mm	450 mm	1	0,560
4200542	20,0 mm	550 mm	600 mm	1	0,680
4200543	22,0 mm	400 mm	450 mm	1	0,640
4200544	22,0 mm	550 mm	600 mm	1	0,760
4200545	24,0 mm	400 mm	450 mm	1	0,760
4200546	24,0 mm	550 mm	600 mm	1	0,920

Vrták do dreva



kód	popis		
420571	08x400 mm	1	0,092
420572	10x400 mm	1	0,096
420573	12x400 mm	1	0,098
420574	16x400 mm	1	0,104

Vrták do betónu 2-hrotový, S2



kód	priemer	pracovná dĺžka	celková dĺžka		
4200483	4,0 mm	50 mm	110 mm	10	
4200484	5,0 mm	50 mm	110 mm	10	
4200488	6,0 mm	50 mm	110 mm	10	
4200485	6,0 mm	150 mm	210 mm	10	
4200489	6,0 mm	200 mm	260 mm	10	
4200491	8,0 mm	100 mm	160 mm	10	
4200490	8,0 mm	150 mm	210 mm	10	
4200486	8,0 mm	200 mm	260 mm	10	
4200487	10,0 mm	100 mm	160 mm	10	
4200492	10,0 mm	150 mm	210 mm	10	
4200493	12,0 mm	100 mm	160 mm	10	
4200494	12,0 mm	200 mm	260 mm	10	
4200495	12,0 mm	400 mm	460 mm	10	
4200496	14,0 mm	100 mm	160 mm	10	
4200497	14,0 mm	200 mm	260 mm	10	
4200498	14,0 mm	400 mm	460 mm	10	

Vrták do betónu, s válcovou stopkou



kód	popis		
4200688	03 mm	1	
4200689	04 mm	1	
4200690	05 mm	1	
4200691	06 mm	1	
4200692	08 mm	1	
4200693	10 mm	1	
4200694	12 mm	1	

Vrták do dreva



kód	popis		
420657	08x400 mm	1	
420695	08x600 mm	1	
420089	10x400 mm	1	
420675	10x600 mm	1	
420432	12x400 mm	100	0,251
420716	12x600 mm	100	0,360
420408	14x400 mm	100	0,195
420723	14x600 mm	1	
420522	16x400 mm	100	0,215
420138	16x600 mm	100	0,210
420033	18x400 mm	1	
420440	18x600 mm	1	

Vrták do dreva - ploché



kód	popis		
420155	08x400 mm	1	
420156	10x400 mm	1	
420160	12x400 mm	1	
420168	16x400 mm	1	

Nástavec na vrtačku



kód	popis		
212207	90° / 0,8-10 mm	1	0,541

Stojan na vrtačku



kód	popis		
113015	stojan	6	2,167
113016	stojan + rohová zvierka	6	2,330

Skľučidlo s kľúčikom



kód	popis		
212464	10 mm, kľúčik	75	0,240
212474	13 mm, kľúčik	5	0,380

Skľučidlo rýchlopínacie



kód	popis		
212880	10 mm	75	0,190
212517	13 mm	5	0,300

Kľúč do skľučidla



kód	popis		
212646	10 mm	100	0,050
212647	13 mm	50	0,520

Vrtačka, kolovrátok

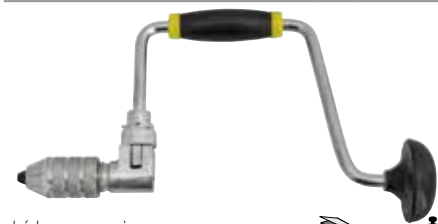

kód	popis		
4209151	do 8 mm, dĺžka 300 mm	1	1,000

Vrták do kovu / 4241 / DIN338



Triada Standard

STREND PRO[®] temer

kód	priemer	ks
4200553	1,0 mm	10
4200554	1,5 mm	10
4200555	2,0 mm	10
4200556	2,5 mm	10
4200557	3,0 mm	10
4200558	3,2 mm	10
4200559	3,5 mm	10
4200560	4,0 mm	10
4200561	4,1 mm	10
4200562	4,2 mm	10
4200563	4,3 mm	10
4200564	4,4 mm	10
4200565	4,5 mm	10
4200566	4,6 mm	10
4200567	4,7 mm	10
4200568	4,8 mm	10
4200569	4,9 mm	10
4200570	5,0 mm	10
4200571	5,1 mm	10
4200572	5,2 mm	10
4200573	5,3 mm	10
4200574	5,4 mm	10
4200575	5,5 mm	10
4200576	5,6 mm	10
4200577	5,7 mm	10
4200578	5,8 mm	10
4200579	5,9 mm	10
4200580	6,0 mm	10
4200581	6,1 mm	10
4200582	6,2 mm	10
4200583	6,3 mm	10
4200584	6,4 mm	10
4200585	6,5 mm	10
4200586	6,6 mm	10
4200587	6,7 mm	10
4200588	6,8 mm	10
4200589	6,9 mm	10
4200590	7,0 mm	10
4200591	7,1 mm	5
4200592	7,2 mm	5
4200593	7,3 mm	5
4200594	7,4 mm	5
4200595	7,5 mm	5
4200596	8,0 mm	5
4200597	8,1 mm	5
4200598	8,2 mm	5
4200599	8,3 mm	5
4200600	8,4 mm	5
4200601	8,5 mm	5
4200602	8,6 mm	5
4200603	8,7 mm	5
4200604	8,8 mm	5
4200605	8,9 mm	5
4200606	9,0 mm	5
4200607	9,2 mm	5
4200608	9,5 mm	5
4200609	10,0 mm	5
4200610	10,2 mm	5
4200611	10,5 mm	5
4200612	11,0 mm	5
4200613	11,5 mm	5

Vrták do kovu / 4241 / DIN338

kód	priemer	ks
4200614	12,0 mm	5
4200615	12,5 mm	5
4200616	13,0 mm	5
4200617	14,0 mm	1
4200618	15,0 mm	1
4200619	16,0 mm	1

Vrták do kovu / M2 / DIN338



Triada Industrial

STREND PRO[®] temer

kód	priemer	ks
4200620	1,0 mm	10
4200621	1,5 mm	10
4200622	2,0 mm	10
4200622	2,4 mm	10
4200623	2,5 mm	10
4200624	3,0 mm	10
4200625	3,2 mm	10
4200666	3,3 mm	10
4200654	3,4 mm	10
4200626	3,5 mm	10
4200664	3,9 mm	10
4200627	4,0 mm	10
4200657	4,1 mm	10
4200628	4,2 mm	10
4200670	4,3 mm	10
4200667	4,4 mm	10
4200629	4,5 mm	10
4200656	4,8 mm	10
4200630	5,0 mm	10
4200671	5,1 mm	10
4200658	5,2 mm	10
4200631	5,5 mm	10
4200632	6,0 mm	10
4200665	6,1 mm	10
4200661	6,2 mm	10
4200668	6,4 mm	10
4200633	6,5 mm	10
4200634	7,0 mm	10
4200676	7,1 mm	10
4200635	7,5 mm	5
4200636	8,0 mm	5
4200663	8,1 mm	10
4200655	8,2 mm	10
4200669	8,4 mm	10
4200637	8,5 mm	5
4200659	8,6 mm	10
4200638	9,0 mm	5
4200660	9,1 mm	10
4200639	9,5 mm	5
4200640	10,0 mm	5
4200641	10,5 mm	5
4200642	11,0 mm	5
4200643	11,5 mm	5
4200644	12,0 mm	5
4200645	12,5 mm	5
4200646	13,0 mm	5
4200672	15,0 mm	10
4200673	16,0 mm	10
4200674	17,0 mm	10
4200675	18,0 mm	10
4200677	20,0 mm	10



Vrták stupňovitý

Triada Standard

STREND PRO[®]



kód	popis	ks	kg
4200552	4-20 mm / TiN	1	0,010

Vrták stupňovitý

Triada Industrial

STREND PRO[®]



kód	popis	ks	kg
4202551	5-35 mm / TiN	1	0,010

Sada stupňovitých vrtákov

Triada Standard

STREND PRO[®]

Triada Industrial

STREND PRO[®]



kód	popis	ks	kg
4200696	Triada Standard 4-12 / 4-20 / 4-32 mm	1	
421172	Triada Industrial 4-12 / 4-20 / 4-32 mm	1	

Sada vrtákov do kovu HSS / DIN338



kód	popis		
4200547	19 dielna / 1-10 mm	1	0,500
4200548	25 dielna / 1-13 mm	1	0,500

Sada vrtákov do kovu HSS / DIN338



kód	popis		
4200549	19 dielna / 1-10 mm	1	0,500
4200550	25 dielna / 1-13 mm	1	0,500

Sada vrtákov do kovu



kód	popis		
420425	10 dielna, 1-2-3-4-5-6-7-8-9-10 mm	50	0,400

Sada vrtákov do kovu



kód	popis		
420157	A) 13 dielna, 1-10 mm	1	0,950
420583	B) 19 dielna, 1-10 mm	1	0,950

Sada vrtákov do kovu



kód	popis		
420141	19 dielna 1-1.5-2-2.5-3-3.5-4-4.5-5-5.5-6-6.5-7-7.5-8-8.5-9-9.5-10 mm	10	1,000

Sada vrtákov do kovu



kód	popis		
4200320	13 dielna 1.5-2-2.5-3-3.2-3.5-4-4.5-4.8-5-5.5-6-6.5 mm	1	0,542

Sada vrtákov do muriva



kód	popis		
420099	5 dielna, 4-5-6-8-10 mm	50	0,140
420050	8 dielna, 3-4-5-6-7-8-9-10 mm	50	0,170

Sada vrtákov do muriva SDS+



kód	popis		
420584	6 dielna, 2x 6-8-10 mm	50	0,340

Sada vrtákov do kovu, SDS+

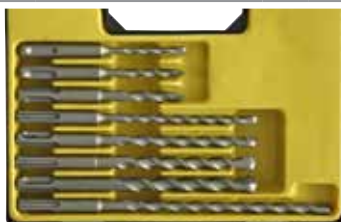

kód	popis		
420470	8 dielna, vrtáky - 5x110, 6x110, 8x110, 6x160, 8x160, 10x160, 12x160, 8x210mm	1	0,500

Sada vrtákov 3v1, kov-drevo-betón



kód	popis		
420603	15 dielna Drevo: 4-5-6-8-10 / Kov: 4-5-6-8-10 / Betón: 4-5-6-8-10	25	0,440

Sada vrtákov 3v1, kov-drevo-betón



kód	popis		
420609	9 dielna, 3x 5-6-8 mm	100	0,280

Sada vrtákov do dreva



kód	popis		
420546	5 dielna, 4-6-8-9-10 mm	50	0,600
420413	8 dielna, 3-4-5-6-7-8-9-10 mm	100	0,160

Ostrič vrtákov



kód	popis		
212558	M3,5-M10mm	6	0,370

SET OF DRILLS AND SCREW-CUTTERS

Sada vrtákov a dlát, SDS+

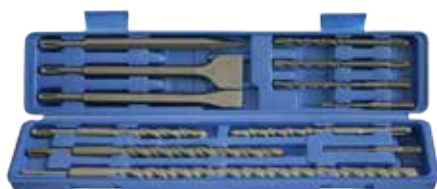

kód	popis		
420673	12 dielna 4x110, 6x110 mm / 8x160, 10x160, 12x16 mm 14x210, 16x210 mm / 18x300 mm špicatý sekáč-14x250 mm plochý sekáč-14x250x20 mm, 14x250x40 mm	10	2,600

Sada vrtákov, SDS+



kód	popis		
420471	13 dielna vrtáky - 6x160, 8x160, 10x160, 8x210, 10x210, 12x210, 10x260, 12x260, 14x260 mm / špicatý sekáč-250 mm plochý sekáč-20x250, 40x250mm / drážkovací sekáč-250mm	1	2,600

Sada vrtákov a hmoždieniek



kód	popis		
420662	vrtáky, hmoždinky, bity	10	1,100

Sada vrtákov a hmoždieniek



kód	popis		
420847	Hmoždinky: 10mm, 8mm, 6mm, 5mm; Magnetický držiak; Špirálovitá vrták: 10-8-6-5-4-2; 10-8-6-5-4 Špirálovitá vrták na drevo: 10-8-6-5-4 Bity: PL 4.5+6 / PH 1+2 / PZ 1+2	10	0,700

Sada závitnic



kód	popis		
222201	3 dielna sada, 1/2"-1"	1	4,500
222682	5 dielna sada, 3/8"-1 1/4"	1	5,500
222681	7 dielna sada, 3/8"-2"	1	13,500

Závitová hlava



kód	popis		
212375	1/2"	20	0,500
212162	3/4"	20	0,620
212402	1"	20	0,770
212406	1/4"	6	0,600
212404	3/8"	50	0,550
212408	1 1/2"	1	2,000
212409	1 1/4"	1	0,720
212410	2"	1	2,000

Hlava rače do závitnice



kód	popis		
224759	Ø 90 mm	1	

Čeľusť do závitnice



kód	popis		
212600	1" - 4 ks	12	0,320
212246	1/2"	12	0,080
212312	2"	12	0,360
212309	3/4"	12	0,110

Sada závitníkov



kód	popis		
222904	6 dielna Hlavice: 1/2" 3/4" 1" 1-1/4" 1ks račňová hlava / 1ks rukoväť / 1ks nádstavec na rukoväť	1	5,375

Sada závitníkov



kód	popis		
222974	7 dielna Hlavice: 1/2" 3/4" 1" 1-1/2" 2" 1ks račňová hlava / 1ks rukoväť / 2ks nádstavec na rukoväť	1	10,000

Závitová hlava



kód	popis		
222159	3/4"	20	0,500
222354	1"	20	0,620
222156	1/2"	20	0,770

Sada fréz do dreva, 12 dielna



kód	popis		
228568	stopka 8 mm, drevený kazeta	1	

Sada fréz do dreva, 35 dielna



kód	popis		
212556	stopka 8 mm, hliníkový kufrik	1	

Sada vyťahovákov, skrutiek



kód	popis		
212219	5 dielna, 3-19 mm	12	0,140

Sada vyťahovákov, HSS 4241



kód	popis		
212606	4 dielna, 8 mm	1	

Sada závitníkov a očiek



kód	popis		
224701	33 dielna	1	1,000

vrátdlo, vrátdlo typu T, závitníková račna
závitové mierky, skrutkovač
5 ks závitníkov typu UNC: 1/4"; 5/16"; 3/8"; 7/16"; 1/2"
5 ks závitových očiek typu UNC: 1/4"; 5/16"; 3/8"; 7/16"; 1/2"
2 ks závitníkov typu BSP: 1/8"; 1/4"
2 ks závitových očiek typu BSP: 1/8"; 1/4"
7 ks závitníkov typu MM: 3x0,5; 4x0,7; 5x0,8; 6x1,0; 8x1,25; 10x1,5; 12x1,75
7 ks závitových očiek typu MM: 3x0,5; 4x0,7; 5x0,8; 6x1,0; 8x1,25; 10x1,5; 12x1,75

Sada závitníkov a očiek



kód	popis		
224038	33 dielna, HOBBY,	10	1,400

Sada závitníkov HSS



kód	popis		
224667	16 dielna, HOBBY	1	0,600



VYKRUŽOVAČE A UNÁŠAČE

Sada vyrezávačov



PROFI
náradie

kód	popis		
212548	16 dielna / Ø 19-127 mm	1	

vyrezávače: 19,22,29,32,38,44,51,54,76,89,102,127 mm
1ks kľúč HEX / 1ks unášač
Použitie: tvrdé drevo, PVC/PE, preglejka, nerez, drevo s klíncami

Sada vyrezávačov



PROFI
náradie

kód	popis		
212417	9 dielna / Ø 22-73 mm	1	

vyrezávače: 22, 29, 38, 44, 67, 73 mm / 2ks adaptérov
Použitie: tvrdé drevo, PVC/PE, preglejka, nerez, drevo s klíncami

Sada vyrezávačov, BiMetal



kód	popis		
212643	9 dielna, BiMetal Ø 22; 29; 35; 44; 51; 64 mm	10	0,190

Sada vyrezávačov



kód	popis		
212038	Ø 64 - 127 mm	20	0,850

Sada vyrezávačov



kód	popis		
212040	Ø 19 - 64 mm	40	0,400

Vyrezávač diamantový



kód	popis		
222872	Ø 05 mm	1	
222841	Ø 06 mm	1	
222886	Ø 08 mm	1	
222351	Ø 10 mm	1	
222450	Ø 12 mm	1	
222403	Ø 20 mm	1	
222933	Ø 25 mm	1	

Vyrezávač Bi-Metal



kód	popis		
226146	Ø 22 mm	1	
226096	Ø 25 mm	1	
226021	Ø 35 mm	1	
226089	Ø 60 mm	1	
226172	Ø 68 mm	1	

Vyrezávač



kód	popis		
222688	Ø 25 mm / 26-63 mm	10	0,150
222687	Ø 50 mm / 26-63 mm	10	0,160

Vyrezávač s krytom



kód	popis		
2160344	Ø 120 mm, na keramické obklady	10	0,400

Vyrezávač dier



kód	popis		
2160343	na keramické obkladačky	6	0,100

Unášač pre vyrezávač Bi-Metal



kód	popis		
212183	Ø 6,5x50 mm	1	0,100

Vrták korunkový s SK plátkami



kód	popis		
4200429	priemer 73 mm	20	0,500
4200695	priemer 100 mm	20	0,500

Vyrezávač dier, nastaviteľný

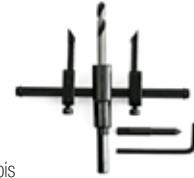

kód	popis		
420934	Ø 30-120 mm do drevotriesky, preglejky, plastových dosiek, sadrokartónu	50	0,200

Korunka na dlažbu



kód	popis		
4200088	Ø 33 mm	1	
4200090	Ø 53 mm	1	
4200086	Ø 67 mm	1	0,150
4200091	Ø 73 mm	1	
4200092	Ø 83 mm	1	

Sada koruniiek



kód	popis		
420076	7 dielna, 33/53/63/73/83 mm	20	0,950

Sada koruniiek



kód	popis		
420013	9 dielna, kufor Ø 33; 53; 67; 73; 83 mm	10	1,800

Unášač pre vyrezávač



kód	popis		
420845	Ø 22x110 mm; SDS+	1	

Zvierka Zn, račňová



kód	popis		
212812	120x1000 mm	1	2,000

Zvierka stolárska



kód	popis		
212980	050x0150 mm	50	0,300
212971	050x0200 mm	50	0,320
212541	050x0250 mm	50	0,340
212972	050x0300 mm	50	0,360
212974	050x0400 mm	25	0,380
212485	120x0300 mm	20	1,200
212166	120x0500 mm	10	1,800

Zvierka stolárska Quick, plast



kód	popis		
212185	150x63 mm	12	0,525
212191	200x63 mm	12	0,575
212258	250x63 mm	12	0,625
212197	300x63 mm	12	0,675
212701	450x63 mm	12	0,825

Zvierka METALKOV, stolárska



kód	popis		
212552	0150 mm	1	1,300
212555	0200 mm	1	1,530
212564	0250 mm	1	1,700
212923	0300 mm	1	2,050
212925	0350 mm	1	2,250
212452	0400 mm	1	2,750
212264	0500 mm	1	3,250
212642	0600 mm	1	3,500
212737	0800 mm	1	4,400
212262	1000 mm	1	4,900
212571	1250 mm	1	5,550
212572	1500 mm	1	6,350

Zvierka Zn, račňová



kód	popis		
212690	200 mm	12	0,200
212838	230 mm	12	0,240

Zvierka, Nylon



kód	popis		
212266	200 mm	12	
212267	250 mm	12	

Zvierka stolárska G



kód	popis		
212261	075 mm	1	
212270	100 mm	1	
212279	150 mm	1	



kód	popis		
212098	3 dielna, 1", 1", 2"	12	0,320

Svorka rúčná



kód	popis		
222239	100 mm	10	0,294
222241	125 mm	10	0,441
222234	150 mm	1	0,570

Svorka rúčná



kód	popis		
222788	050 mm	12	0,830

Držiak magnetický, uhlový



kód	popis		
222883	111x095x25 mm, 12kg, on/off	1	0,528
222884	152x130x38 mm, 25kg, on/off	1	1,000
222908	95x095x025 mm, 12kg, on/off	1	0,667
222909	127x127x38 mm, 25kg, on/off	1	1,250

Držiak magnetický, uhlový

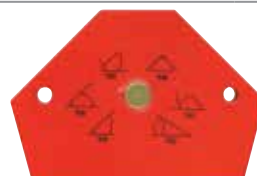

kód	popis		
222910	095x063 mm, 10kg	1	0,175
222917	108x089 mm, 20kg	1	0,639
222918	140x108 mm, 30kg	1	1,125

Držiak magnetický, uhlový



kód	popis		
222880	076 mm, 10kg	1	0,300

Držiak magnetický, uhlový



kód	popis		
222325	102 mm, 20kg	6	0,556
222882	127 mm, 30kg	1	1,167

Zverák York® Standard **YORK**



kód	popis		
222673	Šírka čelusti 63mm Dĺžka upnutia 55mm	1	4,000
222127	Šírka čelusti 80mm Dĺžka upnutia 70mm	1	6,000
222128	Šírka čelusti 100mm Dĺžka upnutia 105mm	1	12,500
222194	Šírka čelusti 125mm Dĺžka upnutia 115mm	1	20,000
222129	Šírka čelusti 150mm Dĺžka upnutia 125mm	1	30,000

Čeluste z vysoko kvalitnej oceli kalené na 52-54 HRC

Náhradná čelusť York®



kód	popis		
222172	063 mm	1	
222173	080 mm	1	
222174	100 mm	1	
212322	125 mm	1	
212757	150 mm	1	

Zverák na trúbky



kód	popis		
212300	do 60 mm	4	5,500

Zverák upínací



kód	popis		
222326	40 mm	20	0,675
222853	50 mm	20	0,750
222854	60 mm	20	1,225

Zverák zámočnický **STREND PRO**



80/100/125/150 mm

180°

NOVINKA



kód	popis		
222083	080 mm	1	
222084	100 mm	1	
222399	125 mm	1	
222087	150 mm	1	

Základňa otočná o 180°

Zverák QUICK



kód	popis		
113430	70 mm	20	0,600

Svorka rohová



kód	popis		
212981	100 mm	1	0,233

Zverák na trúbky Pioneer



kód	popis		
212112	073 mm	6	4,400
212113	090 mm	4	6,250
212122	115 mm	2	9,500
212121	165 mm	1	8,000

Zverák York® Pioneer **YORK**



kód	popis		
222798	stolový	1	4,500

Zverák zámočnický Standard



kód	popis		
212120	080 mm	1	5,050
212013	100 mm	1	9,000
212205	125 mm	1	15,000
212206	150 mm	1	17,000

Tyč rozpínacia



NOVINKA

kód	popis		
216320	50-115 cm, nos. 30 kg	1	
216318	115-290 cm, nos. 30 kg	1	

Zverák York® Pioneer **YORK**



kód	popis		
222045	stojanový, rozsah do 3"	1	16,000

Zdvihák pojazdný



kód	popis		
112413	nosnosť 3 tony, 140-490mm	1	

Zdvihák hydraulický, pojazdný



kód	popis		
112400	nosnosť 2 tony, zdvih 13-34,5 cm	1	10,400

Zdvihák hydraulický, pojazdný



kód	popis		
112414	nosnosť 2.5 tony, zdvih 13-41 cm	1	21,000

Sada podpier s zdvihákom



kód	popis		
112407	nosnosť 2 tony	1	19,000

Podpera



kód	popis		
112385	nosnosť 2 tony, 275-428 mm	1	6,200
112386	nosnosť 3 tony, 288-430 mm	1	7,800

Zdvihák hydraulický



kód	popis		
112420	nosnosť 02 ton	1	3,500
112408	nosnosť 03 ton	1	4,300
112043	nosnosť 04 ton	1	4,300
112409	nosnosť 05 ton	1	5,500
112423	nosnosť 08 ton	1	6,600
112424	nosnosť 10 ton	1	7,100
112366	nosnosť 12 ton	1	8,300
112350	nosnosť 15 ton	1	9,300

Zdvihák nožnicový

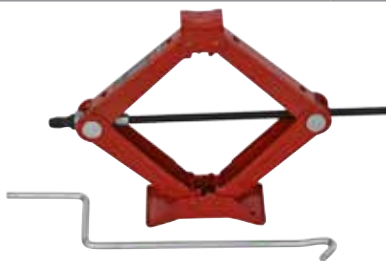

kód	popis		
112039	nosnosť 1 tona, 88-383 mm	1	2,800
112378	nosnosť 2 tony, 90-380 mm	1	3,100

Zdvihák reťazový



kód	popis		
112410	nosnosť 0500 kg	1	9,600
112411	nosnosť 1000 kg	1	9,800
112412	nosnosť 2000 kg	1	12,900

Lehátko pojazdné



kód	popis		
217168	červené, 930x440x105 mm	1	7,000

Napínák lanový



kód	popis		
112357	nosnosť 1 tona, lano 1m, Ø5 mm	10	2,100
112159	nosnosť 2 tony, lano 1m, Ø5 mm	10	2,200
112153	nosnosť 4 tony, lano 1m, Ø5 mm	6	5,500

Naviják



kód	popis		
112119	nosnosť 400 kg, lano 8m, Ø4.5 mm		
112118	nosnosť 800 kg, lano 10m, Ø4.8 mm		
112125	nosnosť 1300 kg, lano 10m, Ø5.0 mm		

Sťahovák dvojramenný



kód	popis		
222377	075 mm	60	0,450
222802	100 mm	40	0,415
222344	150 mm	20	0,700
222345	200 mm	20	0,850
222584	250 mm	20	1,350
222586	300 mm	6	1,980

Sťahovák trojramenný



kód	popis		
222699	075 mm	40	0,380
222698	100 mm	30	0,590
222481	150 mm	16	1,290
222101	200 mm	1	1,400
222231	250 mm	1	2,240
222482	300 mm	1	3,000

HYDRAULIC JACKS, PUMPS AND SHOVELS

Pumpa nožná s tlakomerom 7 bar



kód	popis		
256100	dvojpíestová, píest 55x120 mm Príslušenstvo: adaptéry pre: 1. lopty 2. bicykle 3. matrace...	10	1,330

Pumpa nožná s tlakomerom 7 bar



kód	popis		
221102	jednopíestová, píest 55x120 mm kovový pedál	12	1,250

Pumpa ručná



kód	popis		
256108	A) 38x500 mm	15	1,260
221100	B) 38x500 mm	20	0,800

Hasiaci prístroj



kód	popis		
217321	1kg, 5A, 34B, C / práškový	1	

Pumpa mini



kód	popis		
221103	30x315 mm	100	0,150

Pumpa mini



kód	popis		
221104	25x215 mm	100	0,130

Maznica olejová, ručná



kód	popis		
235110	500cc / 600psi	1	1,300

Manometer



kód	popis		
115290	digitálny	1	0,100

Autoplachta, modrá, PE



kód	popis		
2170086	S - 406x165x119 cm	1	1,100
2170176	M - 432x165x119 cm	1	1,200
2170177	L - 457x165x119 cm	1	1,300
2170178	XL - 482x165x119 cm	1	1,400
2170179	XXL - 508x165x119 cm	1	1,500

Autoplachta, strieborná, PE



kód	popis		
2170180	S - 234x147x51 cm	1	0,400
2170181	M - 259x147x51 cm	1	0,430
2170182	L - 292x147x51 cm	1	0,460
2170183	XL - 317x147x51 cm	1	0,500

Autolopata skladacia 3v1



kód	popis		
2170847	250-620 mm	1	0,955

S textilným obalom. Možnosti: lopata, motyka, pílika. Výrobok vhodný do každého auta. Ľahko zložitelný a skladný.

Autolopata skladacia



kód	popis		
211753	225x340x720 mm	1	

Autolopata skladacia



kód	popis		
2170250	340x265x825 mm	1	
2170254	320x300x800-1000 mm	1	

RUKAVICE

Rukavice "BETTA"



kód	popis		velkosť
313231	10"	12	10

Rukavice



A



B



C



D

kód	popis		velkosť
313561	A) 9" / Carp	12	9
313562	B) 9" / Elver	12	9
313563	C) 9" / Garpike	12	9
313564	D) 9" / Lagena	12	9

Rukavice "CORMORAN"



kód	popis		velkosť
313335	Šitý jemný bielený bavlnený úplet, pružná manžeta.	300	08
313498			10

Rukavice "MORA"



kód	popis		velkosť
313565	9" / zelené	12	9
313566	9" / červené	12	9

Rukavice "DANIO"



kód	popis		velkosť
313534	8"	12	8
313568	9"	12	9

Rukavice "LIMIA"



kód	popis		velkosť
313533	8"	12	8
313569	9"	12	9

Rukavice "AVOCET"



kód	popis		velkosť
313160	Rukavice šité z pestrej bavlnenej tkaniny, dlaň a prsty s farebnými PVC bodkami.	12	09

Rukavice "SAUGER"

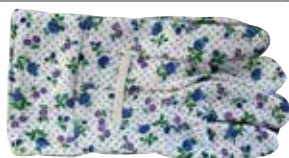

kód	popis		velkosť
313567	9"	12	9

Rukavice "LOON"



kód	popis		velkosť
313523	latexové, jednorázové,	100	L
313522	potravinárske		M
313521			S

Rukavice "BLUETAIL"



kód	popis		velkosť
313550	akryl, polomáčané, latex	12	08
313518			10

Rukavice "BUSTARD"



kód	popis		velkosť
313710	Šitý a bielený bavlnený úplet,	600	07
313708	bez manžety, pružinka na		08
313709	chrbate ruky, dlaň a prsty s		09
313078	drobnými bielymi PVC terčikmi.		10

Rukavice "BULBUL"



kód	popis		velkosť
313628	Bezšvový úplet nylon/bavlna,	300	08
313033	šedo-biely melír.		10

Rukavice "BUNTING", nylon



kód	popis	farba	velkosť
313489	Bezšvový úplet z jemného	čierna	07
313378	bieleho nylonu, pružná	čierna	08
313488	manžeta, dlaň a prsty	čierna	09
313538	pokryté tenkou vrstvou	čierna	10
313868	bieleho polyuretánu.	čierna	11
313487		biela	06
313486		biela	07
313485		biela	08
313206		biela	09
313170		biela	10

Rukavice "DIPPER"



kód	popis		velkosť
313499	Bezšvový úplet s pružným zápästím, polomáčaný v prírodnom zelenom latexe, protišmyková úprava povrchu dlane a prstov.	12	08
313419			09
313343			10

Rukavice "TWITE"



kód	popis		velkosť
313185	Bavlnené rukavice s pružným nápletom na zápästí, polomáčané v žitom prírodnom latexe, protišmyková úprava povrchu dlane a prstov.	120	10

Rukavice "PALAWAN"



kód	popis		velkosť
313420	latexové, nylon	100	07
313524			08
313517			09
313816			10
313421			11

Rukavice "STARLING"



kód	popis		velkosť
313032	Latexové rukavice pre domácnosť, veľúrovňová	120	L
313017	úprava vnútorného povrchu, protišmyková úprava na dlani, žltá farba.		M
313422			S
313279			XL

Rukavice "PLOVER"



kód	popis		velkosť
313775	Bezšvový biely polyesterový úplet s pružným zápästím, dlaň a prsty s modrými PVC terčíkmi.	300	09
313043			10

Rukavice "OSPREY"



kód	popis		velkosť
313205	bavlnené s bodkami z PVC	300	10

Rukavice "REDWING"



kód	popis		velkosť
313377	polomáčané v latexe	1	09
313120			10
313774			11

Rukavice "PELICAN"



kód	popis		velkosť
313395	kombinované, polyester	120	07
313478			08
313394			09
313380			10
313393			11

Rukavice "REDSTART"



kód	popis		velkosť
313712	Šitý bavlnený úplet máčaný	120	27 cm
313036			35 cm
313858			35 cm
313658			45 cm

Rukavice "REDPOL"



kód	popis		velkosť
313244	Šitý bavlnený úplet polomáčaný v PVC, pružná manžeta.	12	10

Rukavice "HARRIER"



kód	popis		velkosť
313630	Bavlnené rukavice polomáčané v nitrile, pružný výplet na zápästí, modrá farba.	12	07
313552			08
313559			09
313171			10
313952			11

Rukavice "KITTIWAKE"



kód	popis		velkosť
313629	Šitý bavlnený úplet, polomáčaný v silnej vrstve nitrilu, pružný náplet na zápästí, farba modrá.	120	09
313191			10
313369			11

Plášť



kód	popis		
313044	A) Ochranný plášť s kapucňou v praktickom balení, polyester/PVC, ochrana proti klimatickým vplyvom.	1	0,750
313132	B) PE pláštenka na ochranu pred dažďom, na opakované použitie, univerzálna veľkosť	1	0,050
313304	C) Ochranný plášť s kapucňou v praktickom balení, polyester/PVC, ochrana proti klimatickým vplyvom.	1	0,750

Rukavice "MAGPIE"



kód	popis		velkosť
313229	Kombinované rukavice, zdvojená dľaň zo šedej a zelenej hovädzej štiepenky, chrbát a tuhá manžeta z bielej bavlnenej tkaniny, podšívka v dlani.	12	10

Rukavice "GULL"



kód	popis		velkosť
313243	Kombinované rukavice, vystužená dľaň zo šedej hovädzej štiepenky, chrbát a manžeta z pruhovanej bavlnenej tkaniny, podšívka v dlani.	12	10
313392			11

Rukavice "EIDER"



kód	popis		velkosť
313317	Kombinované rukavice, nedelená dľaň z jedného kusu silnej šedej hovädzej štiepenky, chrbát a manžeta zo žltej bavlnenej tkaniny, podšívka v dlani.	12	10

Rukavice FIREFINCH



kód	popis		velkosť
313219	kombinované, zimné	12	11

Rukavice "TERN"



kód	popis		velkosť
313314	Kombinované rukavice, dľaň zo žltej hovädzej štiepenky, chrbát a manžeta z pruhovanej bavlnenej tkaniny, podšívka v dlani, ekonomická varianta.	12	09
313061			10
313391			11

Rukavice "PIGEON"



kód	popis		velkosť
313626	Celokožené rukavice, žltá bravčová štiepenka, bez podšívky, pružinka na zápästí.	12	09
313224			10
313627			11

Rukavice "FRANCOLIN"



kód	popis		velkosť
313184	celokožené	12	10

Rukavice "HERON"



kód	popis		velkosť
313396	celokožené	12	09
313357			10
313625			11

Rukavice "PALAWAN"



kód	popis	farba	velkosť
3130133	Zateplené pletené bezšvové nylonové rukavice s vrstvou mikroporézneho paropriepustného latexu v dlani a na prstoch	oranžové	09
3130134		oranžové	10
3130135		oranžové	11
3130131		žlté	09
3130130		žlté	10
3130132	pružný úplet na zápästí	žlté	11

Rukavice "SANDPIPER"



kód	popis		velkosť
313162	Celokožené zväračské rukavice, čierna hovädzia štiepenka, dĺžka 35 cm, kryté švy, bavlnená podšívka.	12	10

Rukavice "MERLIN"



kód	popis		velkosť
313204	Celokožené zväračské rukavice, šedá hovädzia štiepenka, manžeta 15 cm, bez podšívky.	12	11

Rukavice "SNIPE"



kód	popis		velkosť
313203	Celokožené zväračské rukavice, šedá hovädzia štiepenka, tuhá manžeta 7 cm, bez podšívky.	12	11

Obuv lepená 01L



kód	veľkosť		
313452	38	1	1,600
313453	39		
313454	41		
313455	42		
313456	43		
313457	45		
313451	46		
313302	47		
313450	48		



Obuv prešivaná 01P



kód	veľkosť		
313400	39	1	1,700
313025	41		
313398	42		
313399	43		
313397	45		
313403	46		
313402	47		
313401	48		



Sandále Crocks



kód	veľkosť		
211840	veľkosť 36	40	0,261
211876	veľkosť 37	40	0,261
211841	veľkosť 38	40	0,261
211877	veľkosť 39	40	0,261
211842	veľkosť 40	40	0,261
211879	veľkosť 41	40	0,261
211880	veľkosť 43	40	0,261
211881	veľkosť 45	40	0,261

Reflexná vesta "LYNX"



kód	popis		
313238	oranžová farba	100	0,130
313074	žltá farba	100	0,130

Čižmy Ginocchio, gumové



kód	popis		veľkosť
313464-37	Čierne vysoké čižmy,	1	37
313662-38	vyššia odolnosť proti teplu,		38
313012-39	očúchaniu, prepíchnutiu		39
313088-40	a prerezaniu oproti		40
313172-41	obdobným výrobkom z		41
313103-42	PVC, ochrana pred		42
313153-43	klimatickými vplyvmi,		43
313340-44	ktoré niesu výnimočné ani		44
313236-45	extrémne. Zvršok odolný		45
313889-46	vode		46
313890-47			47

Čižmy Kraken, gumové



kód	popis		veľkosť
313462-39	Čižmy vysoké gumové,	1	39
313135-40	vyššia odolnosť proti teplu,		40
313136-41	očúchaniu, prepíchnutiu a		41
313404-42	prerezaniu oproti obdobným		42
313405-43	výrobkom z PVC, ochrana		43
313406-44	pred klimatickými vplyvmi,		44
313407-45	ktoré niesu výnimočné ani		45
313408-46	extrémne.		46
313409-47			47

Čižmy PVC, zelené



kód	popis		
313659	39	10	1,480
313660	41	10	1,500
313728	42	10	1,500
313661	43	10	1,580
313662	45	10	1,580

Chránič kolien NOVINKA



kód	popis		
313828	PVC / TPR, EVA pena	1	

Podporný bedrový pás na telo



kód	popis		
313695	A) veľkosť M	1	0,230
313696	A) veľkosť XL	1	0,230
313693	B) veľkosť M	1	0,254
313694	B) veľkosť XL	1	0,254

Chránič kolien, komfort



kód	popis		
313233	160x200 mm vnútorná časť: pena vonkajšia časť: guma	20	0,650

Chránič kolien



kód	popis		
313196	135x120 mm, gumenné	1	0,450

Chránič kolien NOVINKA



kód	popis		
313829	PVC, EVA pena	1	

Chránič kolien NOVINKA



kód	popis		
313830	PVC, EVA pena	1	

OCHRANNÉ POMÔCKY

Ochranné okuliare



kód	popis		
313573	A) číre ochranné okuliare	12	0,060
313574	B) žlté ochranné okuliare	12	0,060
313575	C) tmavé ochranné okuliare	12	0,060
313576	D) strieborné/zrkadlové okuliare	12	0,060

Ochranné okuliare



kód	popis		
313008	číre	12	0,146

Ochranné okuliare



kód	popis		
313124	plastové	200	0,110

Ochranné okuliare



kód	popis		
313330	číre, plastové	12	0,177

Respirátor • jednorázový



kód	popis		
313056	Tvarovaný respirátor R1085	50	0,005

Ochranné okuliare



kód	popis		
313009	A) číre ochranné okuliare	12	0,058
313570	B) žlté ochranné okuliare	12	0,060
313571	C) šedé ochranné okuliare	12	0,060
313572	D) modré, zrkadlové okuliare	12	0,060

Ochranné okuliare



kód	popis		
313128	číre	12	0,104
313331	žlté	12	0,104

Zváračské okuliare



kód	popis		
313337	s odklapacími zorníkmi	12	0,153

Ochranné okuliare



kód	popis		
313299	číre, nastaviteľné	12	0,094

Respirátor



kód	popis		
313577	A) s výdychovým ventilom	50	0,050
313280	B) skladací, s výdychovým ventilom	1	0,010

Ochranné okuliare



kód	popis		
313198	A) červené, nastaviteľná dĺžka stráníc	12	0,048
313332	B) číre, nastaviteľná dĺžka stráníc	12	0,105
313237	C) žlté, nastaviteľná dĺžka stráníc	12	0,060

Stojan na okuliare



kód	popis		
2170137	5x vešička / plast	1	

Súprava ochranná



kód	popis		
313697	okuliare, chránič sluchu, respirátor	1	0,333

Chránič sluchu E-A-R



kód	popis		
313113	A) Classic	250	0,004
313023	B) Soft	250	0,008

Štít ochranný



kód	popis		
313579	A) nastaviteľný	40	0,388
313151	B) nastaviteľný / PC-20	40	0,350

Ochranný štít



kód	popis		
313301	A) s drátenou mriežkou	50	0,361
313302	B) s bielym plexisklom	50	0,280

Štít ochranný



kód	popis		
313049	ŠP 28 / 220 mm	5	0,250
313050	ŠP 29 / 330 mm	5	0,300

Ochranný štít PROFESSIONAL



kód	popis		
313907	s prilbou a chráničom sluchu	1	1,000

Ochranná prilba Lasogard LP 2017



kód	popis		
313070	modrá	50	0,440
313207	žltá	50	0,440
313336	oranžová	50	0,440
313303	biela	50	0,440
313213	červená	50	0,440
313713	zelená	50	0,440

vhodná pre prácu do 1000V / hmotnosť 310 g, 52-62

Chránič sluchu SNR 27dB



kód	popis		
313281	montovateľný na prilbu	1	0,583
313474	náhradný držiak na chránič sluchu	1	

Chránič sluchu SNR 21dB



kód	popis		
313578	nastaviteľné	60	0,166

Chránič sluchu Lasogard LA 3001



kód	popis		
313109	ZELENÝ / SNR 25dB	60	0,166
313328	MODRÝ / SNR 25dB	60	0,166

Kukla zvaračská, PP



kód	popis		
116162	sklo 90x110 mm	20	0,500

Kukla zvaračská



kód	popis		
116162	sklo 110x50 mm	20	0,500
116050	náhradné sklo 11x5 cm	1	0,050

Kukla Trio 98/1



kód	popis		
116018	sklo 110x90 mm / fibrová	1	0,500

Náhradné sklo



kód	popis		
217679	číre, 110x90 mm	1	
217159	08, 110x90 mm	1	
217160	09, 110x90 mm	1	
217161	10, 110x90 mm	1	
217162	11, 110x90 mm	1	
217026	12, 110x90 mm	1	
217994	13, 110x90 mm	1	

Kukla samostmievacia

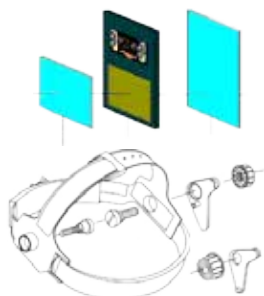

116011

116205

116206

116207

116208

kód popis

220563	Náhradné samostmievacie sklíčko
220561	Predné ochranné sklíčko, 109x93 mm
220562	Vnútorne ochranné sklíčko, 95x43mm
220564	Hlavové popruhy

Rozmer filtra:	110×90×9mm	110×90×9mm
Rozmer zorného poľa:	90×40mm	90×40mm
Rozmer tekutého kryštalu:	96x48mm	96x48mm
Rozmery solarného panelu:	106x28mm	106x28mm
Nastavenie zatemnenia:	Vnútorný gombík	Vonkajší gombík
Tmavé zatemnenia:	DIN9-13	DIN9-13
Svetlé zatemnenie:	DIN4	DIN4
Optické senzory:	2	2
Nahraditeľná lithiova batéria:	Nie	Nie
Indikátorom slabej batérie:	Nie	Nie
Detekcia nízkeho objemu:	Nie	Nie
Funkcia brúsenia:	Nie	Nie
Nastavenie citlivosti:	Áno	Áno
Nastavenie omeškania:	Nie	Áno

Prenosová rýchlosť UV žiarenia:	313-365nm<3.4x10-6%
Prenosová rýchlosť IR žiarenia:	780-1300nm<0.0027% 1300-2000nm<0.0097%
Ochrana proti UV/IR žiareniu:	DIN16
Prepnací čas:	1/20000s z tmavého na svetlé
Čas obnovenia:	0.1s to 0.8s z tmavého na svetlé
Napájanie:	Solárne články
Automatické Vypnutie/Zapnutie:	Áno



Kecky okružné, hobby



kód	popis		
253371	3 dielna	1	0,340
253370	6 dielna	1	0,267

Sada brúsnych teliesok



kód	popis		
253369	10 dielna	25	0,044

Sada brúsnych teliesok



kód	popis		
253372	105 dielna	1	0,170

Sada brúsnych teliesok



kód	popis		
2230049	116 dielna	10	0,400

Sada brúsnych teliesok



kód	popis		
2230048	24 dielna	12	0,189

Sada brúsnych teliesok



kód	popis		
223474	5 dielna	12	0,140

Sada rašplí, rotačné



kód	popis		
223687	5 dielna	20	0,130

Kecka na hrdzu, mosadzná



kód	popis		
253244	250 mm, úzka, kútová	12	0,100

Kecka na hrdzu, oceľová

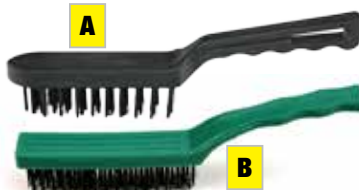

kód	popis		
253286	255 mm / 4 radová, plastová	12	0,150
253263	275 mm / 4 radová, plastová	12	0,100

Sada kartáčov



kód	popis		
227033	4 dielna, 2x175mm a 2x225mm	20	0,210

Kecka na hrdzu, drevená rúčka



kód	popis		
253174	A) 4 radová, oceľová	1	0,133
253131	A) 5 radová, oceľová	12	0,130
253542	B) 4 radová, mosadzná	1	0,125

Kecka na zámkovú dlažbu



kód	popis		
253487	100x40x35 mm / nerezové štetiny / násada 140cm	1	0,222

Kecka na hrdzu



kód	popis		
2160468	160 mm	6	0,139

Kecka oceľová



kód	popis		
253061	4 radová, 255mm, PP+TPR	6	0,167

Kecka mosadzná



kód	popis		
253546	4 radová, 255mm, PP+TPR	24	0,167

Kecka oceľová so škrabkou



kód	popis		
253547	3 radová, 355mm, PP+TPR	12	0,194

Sada, oceľová kecka 2ks



kód	popis		
253545	teleskopická násada 0.8-1.4 m	12	0,583

Kecka oceľová so škrabkou



kód	popis		
253549	4 radová, PP+TPR	12	0,239

Sada na úpravu škár



kód	popis		
253548	4ks, na silikón	12	0,222

Mini sada kefiiek



kód	popis		
253550	oceľ, mosadz, nylon	12	0,111

Kefa okružná, vlnitá oceľ



kód	popis		
253354	100 mm / Ø drôtu 0,30 mm	100	0,225
253355	125 mm / Ø drôtu 0,30 mm	50	0,300
253356	150 mm / Ø drôtu 0,30 mm	1	0,340
253357	175 mm / Ø drôtu 0,30 mm	1	0,340
253358	200 mm / Ø drôtu 0,30 mm	1	0,340

Kefa okružná, vlnitá oceľ



kód	popis		
253136	050 mm / Ø drôtu 0,30 mm	50	0,060
253241	063 mm / Ø drôtu 0,30 mm	200	0,080
253242	075 mm / Ø drôtu 0,30 mm	100	0,100
253243	100 mm / Ø drôtu 0,30 mm	125	0,170

Kefa okružná, nylonová



kód	popis		
253398	50x9 mm	1	0,220
253399	100x12 mm	1	0,220

Kefa misková, 100 mm, M14x2



kód	popis		
253110	A) vlnitá / Ø drôtu 0,30 mm	100	0,260
253171	B) vrkočová / Ø drôtu 0,30 mm	100	0,280

Kefa vrkočová, na stopke



kód	popis		
253125	A) 75 mm / Ø drôtu 0,35 mm	50	0,100
253130	B) 75 mm / Ø drôtu 0,35 mm	1	0,190

Kefa radiálna, vrkočová 100 mm



kód	popis		
253361	M14x2 / Ø drôtu 0,35 mm	1	0,340

Kefa hrncová, vrkočová oceľ



kód	popis		
253129	75 mm / Ø drôtu 0,35 mm	100	0,150

Kefa hrncová, vlnitá oceľ



kód	popis		
253397	050 mm / Ø drôtu 0,30 mm	100	0,089
253365	063 mm / Ø drôtu 0,30 mm	160	0,140
253366	075 mm / Ø drôtu 0,30 mm	100	0,026
253342	100 mm / Ø drôtu 0,30 mm	100	0,060

Kefa hrncová, vrkočová oceľ, M14x2



kód	popis		
253133	065 mm / Ø drôtu 0,35 mm	100	0,300
253134	080 mm / Ø drôtu 0,35 mm	100	0,500
253135	100 mm / Ø drôtu 0,35 mm	50	0,800
253400	120 mm / Ø drôtu 0,35 mm	30	0,600

Kefa hrncová, M14x2, vlnitá oceľ



kód	popis		
253152	075 mm / Ø drôtu 0,30 mm	100	0,270
253175	100 mm / Ø drôtu 0,30 mm	50	0,500
253013	125 mm / Ø drôtu 0,30 mm	1	0,200

Kefa okružná



kód	popis		
253362	100x6 mm / nylon	1	0,400

Kefa koncová, vrkočová



kód	popis		
253395	A) 24 mm / nylon	1	0,220
253396	B) 50 mm / nylon	1	0,220

Sada kartáčov, 3ks, 50-65-75 mm



kód	popis		
212447	2x šrubovacia stopka	1	0,100
212423	3x pevná stopka	1	0,100

Sada kartáčov, 3ks



kód	popis		
212715	2x75 mm / 2x kotúč, 1x kefa	1	0,100

Sada kartáčov, 6ks



kód	popis		
253370	okružná 2x38 mm okružná 50-63-75 mm hrncová 1x50 mm	1	0,267

Sada kartáčov, 5ks



kód	popis		
212484	2x hrncová 50-70 mm 2x okružná 60-75 mm 1x koncová 25 mm	1	0,100

Kefa koncová, vrkočová oceľ



kód	popis		
253363	19x22 mm / Ø drôtu 0,35 mm	1	0,340
253364	22x25 mm / Ø drôtu 0,35 mm	1	0,340
253394	28x25 mm / Ø drôtu 0,35 mm	100	0,086

Kefa koncová, vlnitá oceľ



kód	popis		
253124	12x20 mm / Ø drôtu 0,30 mm	500	0,040
253127	17x22 mm / Ø drôtu 0,30 mm	250	0,050
253126	25x25 mm / Ø drôtu 0,30 mm	250	0,080
253393	30x25 mm / Ø drôtu 0,30 mm	1	0,220

OCEĽ/NEREZ

NEREZ

OCEĽ

KAMEŇ

Tenký rezný kotúč, vystužený ***

2230283	115x1.0x22.2 mm
2230279	115x1.6x22.2 mm
2230168	125x1.0x22.2 mm
2230280	125x1.6x22.2 mm
2230275	125x2.0x22.2 mm
2230276	125x2.5x22.2 mm
2230170	150x1.6x22.2 mm
2230277	150x2.5x22.2 mm
2230281	180x1.6x22.2 mm
2230282	230x1.9x22.2 mm
2230278	230x2.5x22.2 mm

Balenie: 25 ks | Vysoko výkonné kotúče na oceľ a nerez

Rezný kotúč, vystužený ***

2230166	115x1.0x22.2 mm
2230167	115x1.6x22.2 mm
2230225	125x1.0x22.2 mm
2230169	125x1.6x22.2 mm
2230226	150x1.6x22.2 mm
2230171	180x1.6x22.2 mm
2230172	230x1.9x22.2 mm

Balenie: 25 ks | Univerzálne rezanie nerez

Brúsny kotúč, vystužený ***

2230173	115x6.0x22.2 mm
2230174	125x6.0x22.2 mm
2230175	150x6.0x22.2 mm
2230176	180x6.0x22.2 mm
2230177	230x6.0x22.2 mm

Balenie: 10 ks | Univerzálne brúsenie na oceľ

Tenký rezný kotúč, vystužený ***

2230178	115x2.5x22.2 mm
2230179	125x2.5x22.2 mm
2230180	150x2.5x22.2 mm
2230181	180x3.0x22.2 mm
2230182	230x3.0x22.2 mm

Balenie: 25 ks | Univerzálne rezné kotúče na prírodný a umelý kameň

Tabuľka materiálov pre brusné a rezné kotúče T41/T42 Ø115-230 mm

- vysoko vhodné
- menej vhodné

	Štrukturovaná oceľ	Nerezová oceľ	* teplotodolné a CrNi povlakané	* titánové zliatiny	* poniklované zliatiny	Šedá liatina	Tvrhá liatina	Tvárna liatina	Temperovaná liatina	Zliatiny	Prírodný a umelý kameň	* suché rezanie	* suché a mokré rezanie	Plasty
OCEĽ / NEREZ	●	●	●	●	●	●	●	●	●	●				
OCEĽ	○	●	●	●	●	●	●	●	●	●				
KAMEŇ											●	●	●	●

Kotúč KONER D603 - na kov

kód	popis	kg
2230129	115x1,0x22 mm	25
2230130	115x1,6x22 mm	25
2230131	125x1,0x22 mm	25
2230132	125x1,6x22 mm	25
2230133	150x1,6x22 mm	25
2230134	180x1,6x22 mm	25
2230135	230x2,0x22 mm	25

Kotúč flexOvit - na oceľ/nerez

kód	popis	kg
2230006	115x1,0 mm, oceľ/nerez	25
2230007	115x1,6 mm, oceľ/nerez	25
2230008	125x1,0 mm, oceľ/nerez	25
2230009	125x1,6 mm, oceľ/nerez	25
2230010	150x1,6 mm, oceľ/nerez	25
2230011	180x1,6 mm, oceľ/nerez	25
2230021	230x1,9 mm, oceľ/nerez	25
2230002	115x2,0 mm, oceľ	25
2230003	125x2,0 mm, oceľ	25
2230154	115x2,5 mm, oceľ	25
2230004	150x2,5 mm, oceľ	25
2230020	180x2,5 mm, oceľ	25
2230005	230x2,5 mm, oceľ	25
2230024	230x1,9 mm, oceľ	25
2230013	115x6,5 mm, oceľ	25
2230014	125x6,5 mm, oceľ	25
2230012	150x6,5 mm, oceľ	25
2230015	180x6,5 mm, oceľ	25
2230016	230x6,5 mm, oceľ	25
2230026	300x2,8 mm, oceľ	10

Kotúč NORTON - na oceľ/nerez

kód	popis	kg
2230038	115x1,0x22	25
2230036	115x1,6x22	25
2230042	115x6,4x22	10
2230047	125x1,0x22	25
2230035	125x1,6x22	25
2230043	125x6,4x22	10
2230100	150x1,0x22	25
2230146	150x1,6x22	25
2230037	150x2,0x22	25
2230044	150x6,4x22	10
2230039	180x2,0x22	25
2230045	180x6,4x22	10
2230040	230x1,9x22	25
2230162	230x2,0x22	25
2230041	230x2,5x22	25
2230046	230x6,4x22	10
2230032	300x3,0x32	10
2230033	350x3,5x32	10
2230034	400x4,0x32	10

Kotúč DIAMANT - plný



kód	popis		
223917	115 mm	50	0,120
223918	125 mm	50	0,140
223919	150 mm	60	0,300
223920	180 mm	50	0,280
223921	230 mm	25	0,640

Kotúč DIAMANT - turbo +



kód	popis		
223914	115 mm	50	0,120
223915	125 mm	50	0,140
223999	150 mm	50	0,300
223998	180 mm	25	0,640
223916	230 mm	25	0,620

Kotúč DIAMANT - segmentový



kód	popis		
223922	115 mm	50	0,120
223923	125 mm	50	0,140
223924	150 mm	50	0,300
223925	180 mm	50	0,380
223926	230 mm	25	0,640

Sada adaptérov na uhlovú brúsku



kód	popis		
253359	060-125 mm, 4 ks	1	
253360	150-200 mm, 10 ks	1	

Kotúč KONER



kód	popis		
223121	A) 115 mm, segment	50	0,120
223034	A) 125 mm, segment	50	0,130
223013	A) 150 mm, segment	10	0,220
223064	A) 180 mm, segment	10	0,380
223051	A) 230 mm, segment	25	0,680
223388	B) 115 mm, plný	50	0,120
223117	B) 125 mm, plný	10	0,180
223114	B) 150 mm, plný	10	0,220
223372	B) 180 mm, plný	10	0,380
223241	B) 230 mm, plný	5	0,680

Kotúč KONER

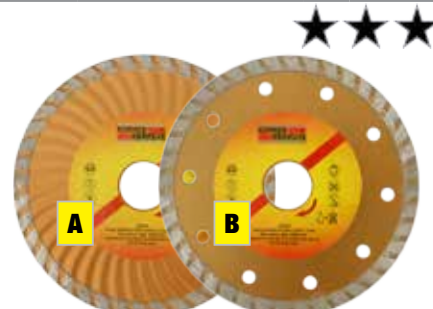

kód	popis		
223120	A) 115 mm, turbo	10	0,240
223341	A) 125 mm, turbo	10	0,260
223263	A) 150 mm, turbo	10	0,220
223376	A) 180 mm, turbo	10	0,380
223368	A) 230 mm, turbo	5	0,680
223527	B) 115 mm, turbo +	5	0,120
223259	B) 125 mm, turbo +	10	0,180
223363	B) 150 mm, turbo +	10	0,220
223377	B) 180 mm, turbo +	10	0,380
223375	B) 230 mm, turbo +	5	0,680

Kotúč KONER - Ultra tenký, 1,2 mm



kód	popis		
223461	115x22.2 mm, diamant	10	
223549	125x22.2 mm, diamant	10	
223462	115x22.2 mm, diamant	10	
223384	115x22.4 mm, diamant	10	

Kotúč KonaFlex - Segment DryCut



kód	popis		
223382	115x1,9x22 mm, Segment	50	0,120
223113	125x1,9x22 mm, Segment	50	0,130
223320	150x1,9x22 mm, Segment	10	0,220
223489	180x2,2x22 mm, Segment	10	0,380
223490	230x2,4x22 mm, Segment	25	0,680

Kotúč KonaFlex - WetCut, plný



kód	popis		
223369	115x1,9x22 mm	10	0,240
223370	125x1,9x22 mm	10	0,260
223240	150x1,9x22 mm	10	0,220
223266	180x2,2x22 mm	10	0,380
223265	230x2,4x22 mm	5	0,680

Kotúč na betón - TurboCup



kód	popis		
223309	B) 115 mm	1	
223566	B) 125 mm	1	
223638	B) 150 mm	1	

Kotúč na betón - 2rowsCup



kód	popis		
2230104	115 mm	1	
2230105	125 mm	1	
2230106	150 mm	1	

Nástroj, rašpľa karbidová



kód	popis		
119264	80 mm, G040	1	

Nástroj, rašpľa karbidová



kód	popis		
119265	35 mm, G040	1	

Nástroj, kotúč karbidový



kód	popis		
119263	65 mm, G050	1	

Nástroj, kotúč na drevo



kód	popis		
119253	87 mm, CrV	1	

Nástroj, píłka na drevo



kód	popis		
119248	10 mm, CrV	1	
119249	22 mm, CrV	1	
119250	34 mm, CrV	1	
119251	68 mm, CrV	1	

Výsek, bal 5ks.



kód	popis		
243951	P60/80/120/180/240	5	

Sada nástrojov



kód	popis		
119268	keramika a dlažba	1	

Nástroj, škrabka



kód	popis		
119260	52x26 mm, SK7	1	

Nástroj, škrabka



kód	popis		
119261	50x75 mm, CrV	1	

Nástroj, kotúč univerzálny



kód	popis		
119259	87 mm, CrV	1	

Nástroj, píłka univerzálna



kód	popis		
119254	32 mm, Bi-Metal	1	

Nástroj, držiak Velcro



kód	popis		
119267	80 mm	1	
119266	93 mm	1	

Sada nástrojov



kód	popis		
119269	drevo a podlaha	1	

Sada nástrojov



kód	popis		
119270	univerzálna	1	

List do chvostovej píly



kód	popis		
226408	455/1.5 mm, tehla	1	

List do chvostovej píly



kód	popis		
226210	150/0.9 mm, kov / BIM	1	

List do chvostovej píly



kód	popis		
226209	225/0.9 mm, kov / BIM	1	

List do chvostovej píly



kód	popis		
226446	225/0.9 mm, kov&drevo / BIM	1	

List do chvostovej píly



kód	popis		
226345	150/1.25 mm, drevo / HCS	1	
226447	300/1.25 mm, drevo / HCS	1	

Spájkovacia súprava



kód	popis		
217559	1.6 kW, PIEZO zapaľovanie Používa kartuše KP02002. - kartuš na ventil	1	

Lampa SuperKit



kód	popis		
217402	170g / kartuš na závit 300ml	1	0,420

Lampa



kód	popis		
217405	PIEZO zapaľovanie závitový ventil 7/16" / max. teplota 2100°C / kartuš na ventil	1	0,400

Klmpiarská pájka



kód	popis		
220635	bez hadice	1	0,830
220636	s hadicou 1,5m	1	1,000

na propán-bután / 4,2 kW / tryska Ø 20 mm

Horák



kód	popis		
220199	bez hadice	1	0,580
220634	s hadicou 1,5m	1	0,670

na propán-bután / 4,2 kW / tryska Ø 20 mm

Horák

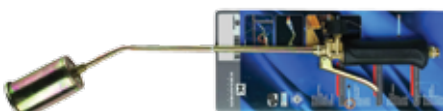

kód	popis		
220638	60x860 mm	1	1,330
220637	60x630 mm	1	2,000

na propán-bután / 79kW

Lampa, Piezo zapaľovanie



kód	popis		
217444	Výkon: 1,37 kW Max. spotreba: 105 g/hod Závitové kartuše: 7/16" Dosiagnuteľná teplota: 1900°C	1	0,500

Spájkovacia súprava



kód	popis		
222824	brašňa	1	

S touto súpravou je možné vykonávať mäkké spájkovanie cínom, spájkovanie natvrdo drobných predmetov. Je vhodná na opaľovanie starých náterov a pre rôzne druhy ohrevu. Je pripojená pomocou ventilu a hadice k 2 kg propán-butanovej fľaši.

Kartuš



kód	popis		
217344	A) 390ml / 227g / bután - ventilová	1	0,360
217254	B) 600ml / 330g / propán-bután - závitová	1	0,460

Plyn



kód	popis		
217835	150ml / bután / balenie 20ks	20	0,150

Hubica so závitom



kód	popis		
220098	45 mm	1	0,240
220099	60 mm	1	0,400

Vypaľovačka do dreva



kód	popis		
217730	10 dielna	1	0,600

Elektrická odporová spájka vhodná pre rytie, gravírovanie, spájkovanie (drevo, korok, koža, plasty, papier, rezanie šablón, klasické spájkovanie cínom apod ..) / Prepínateľný výkon: 20 alebo 40 W
Dĺžka privádzajúceho kábla 110 cm / Napájanie: 230 V
Teplota hrotu 20W = cca 380 ° C / Teplota hrotu 40W = cca 480 ° C
Bez časového obmedzenia práce s prístrojom

Pajka



kód	popis		
217934	7 dielna / mikro-spájkovacia súprava	1	0,470

Plynová mikropájací sada s otvoreným a uzavretým plameňom v praktickej a odolnej plastovej krabičke. Plynulá regulácia plameňa. Spájka je vybavená podstavcom pre odloženie spájky. Balenie obsahuje: katalytický hrot, tvarovacie nôž, 2ks spájkovacie hroty-nástavce, spájkovacia Spongia, cievku cínu. Odporúčame plniť plničom do mikropájek prípadne do zapaľovačov. Doba prevádzky na jedno naplnenie: cca 60 min. Kapacita zásobníka plynu: 8 ml / Teplota plameňa 1300 ° C / Teplota hrotu 400 ° C / Zapaľovanie: manuálne / Rozmer spájky: Ø20 x 176 mm

Zapaľovač, Flexi, 27,5 cm



kód	popis		
217971A	PIEZO zapaľovanie	16	0,090

flexibilný nástavec, detská poistka, regulácia plameňa

Zapaľovač, Pevný, 27,5 cm



kód	popis		
217256A	PIEZO zapaľovanie	16	0,090

detská poistka, regulácia plameňa

Zvárační drát



kód	popis		
214239	0,6 mm / 5 kg, OK Autrod		1
214368	0,8 mm / 5 kg, OK Autrod		1
214999	1,0 mm / 5 kg, OK Autrod		1
214990	0,8 mm / 15 kg, WELD G3Si1		1
214886	0,8 mm / 15 kg, OK Autrod		1
214991	1,0 mm / 15 kg, WELD G3Si1		1
214869	1,2 mm / 15 kg, WELD G3Si1		1
214217	1,2 mm / 18 kg, OK Autrod		1
214347	1,2 mm / 15 kg, ER70S-6		1

Drôt na zvaranie

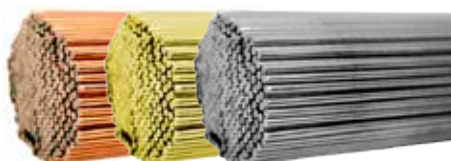

kód	popis		
214419	pomedený / 1,60 mm / Gill-104	1	
214690	pomedený / 2,00 mm / Gill-104	1	
214689	pomedený / 2,50 mm / Gill-104	1	
214688	pomedený / 3,20 mm / Gill-104	1	
214693	pomedený / 4,00 mm / Gill-104	1	
214022	mosadzný / 2,00 mm	1	
214008	mosadzný / 2,50 mm	1	
214023	mosadzný / 3,15 mm	1	
214074	mosadzný / 4,00 mm	1	
214062	čierny / 1,60 mm / GI-102	1	
214685	čierny / 2,00 mm / GI-102	1	
214686	čierny / 2,50 mm / GI-102	1	
214687	čierny / 3,20 mm / GI-102	1	
214039	čierny / 4,00 mm / GI-102	1	

Držiak elektród



kód	popis		
116055	200 A	1	0,440
116024	300 A	1	0,513
116074	400 A	1	0,525
116035	500 A	1	0,600

Šírka svorky 6,35 mm; Dĺžka 250 mm

Kliešte uzemňovacie



kód	popis		
116002	315 A	100	0,180
116134	400 A	100	0,130
116142	500 A	50	0,340

Elektródy



kód	popis		
214363	E-R 117 / 2,0x300 mm	410	0,011
214364	E-R 117 / 2,5x350 mm	250	0,020
214359	E-R 117 / 3,2x350 mm	180	0,030
214087	E-R 117 / 4,0x350 mm	120	0,047
214102	E-B 121 / 2,0x300 mm	258	0,013
214107	E-B 121 / 2,5x350 mm	171	0,022
214783	E-B 121 / 3,2x350 mm	124	0,031
214132	E-B 121 / 3,2x450 mm	124	0,041
214126	E-B 121 / 4,0x450 mm	86	0,063
214764	E-B 121 / 5,0x450 mm	56	0,094
214522	OK-Ni-CI / 2,5x300 mm	41	0,017
214523	OK-Ni-CI / 3,2x350 mm	24	0,033
214941	OK-NiFe-CI-A / 5,0x450 mm	43	0,017
214204	OK 48.00 / 1,6x300 mm	172	0,009
214134	OK 48.00 / 2,5x350 mm	171	0,026
2140008	OK 48.00 / 4,0x450 mm	86	0,074
214232	OK 61.85 / 2,5x300 mm	43	0,016
214290	OK 61.85 / 3,2x350 mm	53	0,032
214123	OK 63.80 / 2,0x300 mm	48	0,013
214124	OK 63.80 / 2,5x300 mm	38	0,019
214017	OK 63.80 / 3,2x350 mm	46	0,037
214478	OK 63.85 / 2,5x300 mm	46	0,018
214360	OK 63.85 / 3,2x350 mm	51	0,034
214361	OK 63.85 / 4,0x350 mm	33	0,052

Elektródy rutilové AWS



kód	popis		
214860	E6013 / 2,0 mm, bal. 25ks	25	0,280
214861	E6013 / 2,5 mm, bal. 25ks	25	0,410
214862	E6013 / 3,2 mm, bal. 15ks	15	0,395
214864	E7018 / 2,5 mm, bal. 25ks	25	0,410
214865	E7018 / 3,2 mm, bal. 15ks	15	0,395

Kliešte samosvorné



kód	popis		
229611	3 dielna	10	0,325

4 1/4" kliešte so zahnutými čelustami; 4 3/4" kliešte s C-zvierkovými čelustami; 5" kliešte s ihlovými čelustami; protišmyková rúčka; kovaná zliatina

Kladivo zváračské



kód	popis		
230101	500 g	1	0,100

Cín PbSn 60%, tyčový



kód	popis		
214084	M	1	

Cín návin S-Sn60Pb k spájkovaniu



kód	popis		
214211	1,00 mm / 100g	1	
214263	1,50 mm / 100g	1	
214152	2,00 mm / 100g	1	
214824	2,00 mm / 500g	1	

Kalafonia Rosin k spájkovaniu



kód	popis		
215399	40 g	1	
214089	100 g	1	

Pasta Felder k spájkovaniu



kód	popis		
243213	A) 50g	1	
243212	A) 100g	1	
243214	A) 250g	1	
A) k spájkovaniu medi a zliatin medi, niklu, zliatin niklu			
243092	B) 250g	1	
243091	B) 500g	1	
B) pre tvrdé spájkovanie medi a ich zliatin, ocele a mosadze			

Tetraboritan sodný, Borax



kód	popis		
214242	500g	1	

Borax sa používa na rôzne technické účely v poľnohospodárstve, pri spracovaní koží, pre impregnáciu dreva, ako tavidlo atď...

Kresadlo



kód	popis		
2170531	GD14001	1	

Kresadlo z magnéziovej zliatiny. Umožní urobiť oheň kedykoľvek, bez obáv o zvlhnutiu zápalek alebo nefunkčnosti zapalovača

Kartuše 190g, 230g, 460g



kód	popis		
217713	A) propán-bután (prepichovacia)	1	0,100
217714	B) propán-bután (štandardný závit) Určené pre variče ATOS a APOLLO	1	0,100
217722	C) propán-bután (štandardný závit) Určené pre variče ATOS a APOLLO	1	0,100

Variče ATOS



kód	popis		
217529	na kartuše s ventilom a závitom.(KP02006 a KP02007).	1	3,000

Variče ATOS



kód	popis		
217704	B) Piezo zapalovanie	1	3,000

Varič PICAMP



kód	popis		
217790	dvojhorákový	1	3,000

Campingový varič na propán-bután je určený pre turistické použitie na prípravu jedál. Je pripojený priamo na propan butanovú fľašu s prevádzkovým tlakom max. 1,7 Mpa. **Plynová fľaša nie je súčasťou výrobu.**



Varič SPARK



kód	popis		
2170528	2.6 kW	1	

Varič je dodávaný v praktickom cestovnom púzdre. Používa kartuše s ventilom a závitom. (KP02006 a KP02007). **Plynová fľaša nie je súčasťou výrobu.**

Varič MAGNUM



kód	popis		
2170527	2.1 kW	1	

pripája sa k 2 kg LPG fľaši cez jednocestný ventil 2156A

Varič SOLO



kód	popis		
217531	jednohorákový	1	3,000

Kempingový varič na propán bután je určený pre turistické účely k príprave pokrmov. Je pripojený priamo k 2 kg propán-butánovej fľaši. **Plynová fľaša nie je súčasťou výrobu.**

Varič SPIDER



kód	popis		
2170529	3 kW	1	

Varič je vďaka svojej konštrukcii veľmi stabilný, maximálne zaťaženie roštu je 10 kg. Používa kartuše s ventilom a závitom (KP02006 a KP02007). **Plynová fľaša nie je súčasťou výrobu.**

Varič FOCUS



kód	popis		
217691		1	3,000

Vysoko kvalitný turistický varič, dlhá životnosť. Používa jednorázové prepichovacie kartuše (KP02001)

Teplomet



kód	popis		
221858	propán-bután	1	2,000

Teplomet na propán bután je určený pre nárazové zvýšenie teploty v miestnostiach. Nie je určený pre dlhodobé vytápanie. Je pripojený k propán butánovej fľaši s prevádzkovým tlakom max. 1,7 MPa. **Propán-butánová fľaša nie je súčasťou výrobu.**

Varič kempingový



kód	popis		
2171100	Výkon: 2,2 kW Max. spotreba: 160 g/hod Rozmery: 33x28x9 cm Čas varu: 5 min 30s Čas prevádzky: 1h 15 min Typ kartuše: ventilová 250 g Váha: 1,43 kg - piezoelektrické zapalovanie - prenosný kufrik - plechový rošt	1	

Varič THUNDER, kempingový



kód	popis		
2170530	2 kW Prenosný varič. Piezo elektrické zapalovanie. Praktické balenie v cestovnom kufriku. Používa ventilové kartuše KPO2002. Plynová fľaša nie je súčasťou výrobu.	1	

Varič CHELSEA, stolový



kód	popis		
2171094	dvojhorákový Max. spotreba: 277 g/h Výkon: 2,9 kW - ľavý horák: 1,2 kW / spotreba: 87 g/hod - pravý horák: 1,7 kW / spotreba: 124 g/hod - použitie s propán butánovou fľašou - regulátor a hadica PVC 0.8m - odnímateľný kryt - výborna kvalita, ľahké čistenie, odnímateľné rošty - vhodné pre kempovanie, rabačku, túry do hôr - typ plynu propán, bután a ich kombinácia	1	

Varič SPORT, stolový



kód	popis		
217690	stolový Stolový kempingový varič na propánbután je určený pre turistické účely k príprave pokrmov. Je vhodný i pre použitie v domácnosti. Varič je pripojený pomocou ventilu a hadice k propán-butánovej fľaši 2 kg. Plynová fľaša nie je súčasťou výrobu.	1	1,900

Varič priemyselný, 7,5 kW

NOVINKA



kód	popis		
2171099	Výkon: 7,5 kW Max. spotreba: 540 g/hod Maximálne zaťaženie roštu: 100 kg Rozmery: 40x40x18 cm Váha: 7 kg - používať len v dobre vetraných priestoroch - železný horák - hrúbka rámu 2,5 mm - použitie s propán butánovou fľašou - piezoelektrické zapalovanie	1	

Varič priemyselný, 5,5 Kw



kód	popis		
2170118	5,5kW / priemyselný varič	1	5,250

Varič priemyselný, 7,5 kW



kód	popis		
2171098	Výkon: 7,5 kW Max. spotreba: 540 g/hod Maximálne zaťaženie roštu: 100 kg Rozmery: 40x40x18 cm Váha: 6 kg - používať len v dobre vetraných priestoroch - železný horák a nožičky - použitie s propán butánovou fľašou - bez hadice a regulátora	1	

Varič priemyselný, 5,5 Kw



kód	popis		
2170003	5,5kW / priemyselný varič / liatina	1	4,000

Lampa, Piezo zapalovanie



kód	popis		
2171103	Výkon: 1,5 kW Max. spotreba: 110 g/hod Ø trysky: 0.25 mm - piezoelektrické zapalovanie - nastavenie intenzity plameňa - ergonomicky tvarovaná rukoväť s jednoduchým ovládaním	1	

Lampa



kód	popis		
217299	PIEZO zapalovanie / kovová kazeta patentovaný bezpečnostný systém proti odblokovaniu kazety 0,670kg, kartuš prepichovacia	1	
217342	PIEZO zapalovanie / plastová kazeta patentovaný bezpečnostný systém proti odblokovaniu kazety 0,590kg, kartuš prepichovacia	1	
217827	MANUAL / plastová kazeta patentovaný bezpečnostný systém proti odblokovaniu kazety 0,590kg, kartuš prepichovacia	1	

Spájkovacia súprava



kód	popis		
217126	PIEZO zapalovanie Výkon: 1760 W Spotreba: 127 g/hod - kartuš prepichovacia	1	0,600

Súprava opaľovacia



kód	popis		
222670	Výkon: 1,5 kW Spotreba: 112 g/h Hmotnosť bez fľaši: 0,9 kg Stredná teplota: 900 °C	1	0,100

Súprava opaľovacia



kód	popis		
222729	Výkon: 1,2 kW Spotreba: 80 g/h Hmotnosť bez fľaši: 0,9 kg Stredná teplota: 970 °C	1	0,100
222730	Výkon: 3,5 kW Spotreba: 238 g/h Hmotnosť bez fľaši: 0,9 kg Stredná teplota: 1170 °C	1	0,100

Horák opaľovací



kód	popis		
220296	Výkon: 79kW Dĺžka nadstavca: 350 mm Celková dĺžka: 860 mm Priemer hubice: 60 mm Nastaviteľný tlak: 0,5-3 bar Dĺžka hadice: 5 m	1	1,000

Hadica s koncovkami



kód	popis		
220617	2x koncovka M9x0,75; 1,2 m	1	
220618	2x koncovka M9x0,75; 1,7 m	1	
220619	2x koncovka M9x0,75; 2,5 m	1	
220329	2x koncovka G1/4" L; 1,5 m	1	

Hadicová rozdvojka



kód	popis		
2170534	80x5 mm	1	

Regulátor tlaku



kód	popis		
217728	A) C30 / UK8mm / EN12864	1	
2170134	B) C30 / G1/4"LH / EN12864	1	
217479	C) 0-4 bar.	1	

Nátrubok s maticou



kód	popis		
2170532	A) 8 mm; G 3/8" L	1	
2170533	B) 8 mm; G 1/4" L	1	
217491	C) 8 mm; W 21,8 LH	1	
2170535	D) 9 mm; 0,75 mm	1	

Jednocestný ventil



kód	popis		
212885	A) G 3/8" L	1	
212828	A) W 21,8 L	1	
212822	B) M9x0,75 mm	1	
212886	C) W 21,8 L; bočný	1	

Horák opaľovací



kód	popis		
220009	55 cm / 60 mm / bez hadice	10	0,900
220577	55 cm / 60 mm + hadica 1.5 m	10	0,950

Horák opaľovací



kód	popis		
220588	35 cm / 30-40-50 mm + hadica	1	0,700

Horák opaľovací



kód	popis		
220589	35 cm / 12-15-17 mm + hadica	1	1,050

Hadica Cellfast LPG



kód	popis		
256448	9,0x3,0 mm - na prepravu zemného plynu, (propán-bután) - extrémne odolná voči poškodeniu s horúcim predmetom - osvedčenie o bezpečnosti - farba vonkajšia - orange, vnútorna - black - teplotný rozsah -10 / +50 °C	50 m	0,154

Hadica LPG



kód	popis		
220258	9,0x15,0 mm - na prepravu zemného plynu, (propán-bután) - extrémne odolná voči poškodeniu s horúcim predmetom - teplotný rozsah -10 / +50 °C	50 m	0,154

Hadica Cellfast ACETYLENE



kód	popis		
256449	9,0x3,0 mm - na prepravu acetylénu - extrémne odolná voči poškodeniu s horúcim predmetom - osvedčenie o bezpečnosti - farba vonkajšia - orange, vnútorna - black - teplotný rozsah -15 / +50 °C	50 m	0,154

Hadica Cellfast OXYGEN



kód	popis		
256450	6,0x3,0 mm - na prepravu kyslíka - extrémne odolná voči poškodeniu s horúcim predmetom - osvedčenie o bezpečnosti - farba vonkajšia - blue, vnútorna - black - teplotný rozsah -15 / +50 °C	50 m	0,120

Pilový list do záhradných píl "5261"



kód	popis		
226127	300 mm	1	

- Pre píly 22 5263, 22 5265 a 22 5267
- List so šikmým nekaleným zubom pre rezanie suchého dreva

Pilový list do záhradných píl "5277"



kód	popis		
226098	A) 500 mm	1	
226069	B) 500 mm	1	
226070	C) 500 mm	1	

- A) stolársky list so šikmým ozubením pre pozdĺžne i priečne rezanie väčších drevených dielov
- B) osadzovací list so šikmým ozubením pre pozdĺžne i priečne rezanie menších a stredných drevených dielov
- C) vykružovací list so šikmým ozubením pre vyrezávanie tvarových otvorov do drevených dielov

Rám lupienkovej píly



kód	popis		
226168	120 mm	1	

Rám píly na kov



kód	popis		
212509	300 mm	1	

Pokosnica drevená



kód	popis		
212999	250x97/65 mm	5	0,590

Pilový list do obloukových píl "5244"



kód	popis		
226439	610 mm	1	
226076	760 mm	1	
226138	800 mm	1	
226278	900 mm	1	
226097	914 mm	1	
226109	1000 mm	1	

- Hoblňovacie ozubenie na rezanie suchého i surového dreva
- Kalené hroty zubov s predĺženou životnosťou

Pilový list do záhradných píl "5260"



kód	popis		
226067	300 mm	1	

- Pro píly 22 5263, 22 5265 a 22 5267
- list s rovným nekaleným zubom na rezanie surového dreva

Pilový list do mäsiarskej píly "5256"



kód	popis		
226128	450 mm	1	

- Optimálne zvolená zubová medzera pre jednoduchý rez

Pilový list na kov • obojstranný



kód	popis		
226145	300 x 20 x 0,65 mm	1	

- Pilový list na kov z legovanej ocele
- Kalené jednostranné ozubenie a vlnovitý rozvod zubov
- Vhodný k rezaniu ocele, farebných kovov a plastov

Pilový list na kov • jednostranný



kód	popis		
226007	300 x 13 x 0,65 mm	1	

- Pilový list na kov z legovanej ocele
- Kalené jednostranné ozubenie a vlnovitý rozvod zubov
- Vhodný k rezaniu ocele, farebných kovov a plastov

Pilový kotúč na drevo 5310 - 56KV25°



kód	popis		
223571	200 x 1,2 x 25 mm	1	
223100	200 x 1,6 x 25 mm	1	
223625	250 x 1,8 x 25 mm	1	
223102	300 x 1,6 x 30 mm	1	
223422	300 x 2,0 x 30 mm	1	
223149	350 x 2,2 x 30 mm	1	
223185	350 x 2,8 x 30 mm	1	
223485	400 x 2,0 x 30 mm	1	
223147	400 x 2,5 x 30 mm	1	
223244	400 x 3,0 x 30 mm	1	
223424	450 x 2,8 x 30 mm	1	
223356	500 x 2,5 x 30 mm	1	
223423	500 x 3,0 x 30 mm	1	
223988	550 x 3,0 x 30 mm	1	
223084	600 x 2,8 x 30 mm	1	
223085	600 x 3,5 x 30 mm	1	
223105	700 x 3,2 x 35 mm	1	
223328	700 x 3,5 x 35 mm	1	

- Pilový kotúč s vličím ozubením.
- Pozitívny uhol čela 25°.
- Na priečne i pozdĺžne rezanie mäkkého i tvrdého dreva.
- Maximálny rozvod - 1/3 hrúbky kotúča na každú stranu.

Oblúková píla "5254"



kód	popis		
226024	530 mm	1	
226025	610 mm	1	
226026	760 mm	1	
226099	800 mm	1	
226027	914 mm	1	

- Univerzálna píla na rezanie suchého i surového dreva
- Vymeniteľný list s hoblňovacím ozubením 22 5244.1
- Kalené hroty zubov s predĺženou životnosťou

Píla na pórobetón



kód	popis		
226273	450 mm, 11z	5	0,550
226316	450 mm, 22z	5	0,550

Záhradná prerezávacía pilka



kód	popis		
226030	165 mm 22 5264	1	

- Pilka s jemným ozubením k prerezávaniu rýbeží a ruží
- Pevný rám s plastovou rukoväťou
- Náhradný list 22 5264.1, šírka 7,5 mm

Záhradná prerezávacía pilka



kód	popis		
226031	300 mm 22 5265	1	

- Záhradnícka pilka k prerezávaniu ovocných stromov a kríkov
- Vhodné na rezanie konárov malých a stredných priemerov

Prerezávacía pilka na násadu



kód	popis		
226032	300 mm 22 5267	1	

- Pilka k nasadeniu na tyč k prerezávaniu vetiev v korunách stromov
- Kvalitné napnutie listu zaručené napínacou pákou a tuhým rámom z plochej ocele
- Rýchle a jednoduché natočenie a výmena listu, voliteľný uhol rezu

Záhradnícka píla natáčacia s napínacou páčkou



kód	popis		
226029	300 mm	1	

- Záhradnícka pilka k prerezávaniu ovocných stromov a kríkov
- Kvalitné napnutie listu zaručené napínacou pákou a tuhým rámom z plochej ocele
- Voliteľný uhol rezu
- Rýchla výmena a otočenie listu

Pilka prerezávacía



kód	popis		
226012	170 mm, sklápacia	1	0,27

Pilka prerezavacia s tulejou



kód	popis		
226046	300 mm	10	0,250

Čapovka rovná



kód	popis		
226035	250 mm 22 5280	1	

- Stolárska pilka na rezanie pod uhlom a naprieč vláknami
- Jemné, nekalené zuby pre hladký a priamy rez
- Vystužený chrbát, vhodná na rezanie v pokosnici

Čapovka s vyhnutou rukoväťou



kód	popis		
226169	250 mm 22 5281	1	

- Stolárska pilka s vyhnutou rukoväťou umožňujúca úrovňové rezanie s hladkým rezom
- Jemné nekalené zuby pre hladký a priamy rez
- Vysoká tuhosť pítky zaručená oceľovou výstužou chrbta

Čapovka s preklápaciou rukoväťou



kód	popis		
226170	165 mm 22 5282	1	

- Pilka s jemným ozubením k prerezávaniu rýbeží a ruží
- Pevný rám s plastovou rukoväťou
- Náhradný list 22 5264.1, šírka 7,5 mm

Mäsiarska pilka "5257"



kód	popis		
226028	450 mm	1	

- mäsiarska pilka na rezanie kostí v mäsovom priemysle
- rám z masívnej plochej ocele
- chrómované spojovacie diely
- lakovaná drevená, ergonomicky tvarovaná rukoväť
- vymeniteľný oceľový list 22 5256

Chvostovka s chrbtom



kód	popis		
226048	250 mm	1	
226036	315 mm	1	

- Výkonná píla na rezanie dreva a plastu
- drevená, ergonomicky tvarovaná rukoväť
- Kalené zuby pre jednoduchý rez

Rám na kov



kód	popis		
226301	300 mm, ALU profi	1	0,660

Dierovka



kód	popis		
226085	250 mm 22 5291A	1	
226158	315 mm 22 5291A	1	

- Píla na rezanie tvarových otvorov v drevených alebo plastových dieloch
- Otvorená plastová ergonomicky tvarovaná rukoväť
- Kalené zuby s 3 reznými hranami pre jednoduchý rez

Chvostovka s uzavretou rukoväťou



kód	popis		
226039	400 mm 22 5286.1A	1	
226040	500 mm 22 5286.1A	1	

- Výkonná píla na rezanie dreva a plastu
- Uzatvorená ergonomicky tvarovaná plastová rukoväť
- Kalené zuby s 3 reznými hranami pre jednoduchý rez
- Možnosť odmeriavať uhol 45° a 90° pomocou rukoväti

Chvostovka s otvorenou rukoväťou



kód	popis		
226037	250 mm 22 5285.1A	1	
226038	315 mm 22 5285.1A	1	

- Výkonná píla na rezanie dreva a plastu
- Otvorená plastová ergonomicky tvarovaná rukoväť
- Zuby s 2 reznými hranami pre rýchly a jednoduchý rez

Chvostovka s uzavretou rukoväťou



kód	popis		
226159	400 mm 22 5286.1B	1	
226092	500 mm 22 5286.1B	1	

- Výkonná píla na rezanie dreva a plastu
- Tradičná drevená, ergonomicky tvarovaná rukoväť
- Kalené zuby s 3 reznými hranami pre jednoduchý rez

Pilka na izolačné materiály



kód	popis		
226141	400 mm	1	
226205	450 mm	1	

Kotúč pílový SuperSaw NWP



kód	popis		
2230062	160x2,5x20 z24	10	0,290
2230063	200x2,5x20 z32	10	0,840
2230064	250x3,2x30 z40	10	0,840
2230065	300x3,2x30 z48	10	0,840
2230066	350x3,6x30 z54	10	0,840
2230067	400x3,6x30 z64	10	0,840

Kotúč pílový SuperSaw NWS



kód	popis		
2230054	160x2,5x20 z48	10	1,890
2230055	200x2,5x20 z64	10	1,890
2230056	250x3,2x30 z72	10	2,470
2230057	300x3,2x30 z96	10	2,470

Kotúč pílový SuperSaw NWG



kód	popis		
2230068	160x2,5x20 z16	10	0,290
2230069	200x2,5x20 z24	10	1,220
2230070	250x3,2x30 z32	10	1,220
2230071	300x3,2x30 z36	10	1,220
2230073	400x3,6x30 z48	10	1,890

Kotúč pílový CW



kód	popis		
2230074	200x1,6x25 z56	10	0,400
2230075	250x1,6x25 z56	10	0,620
2230087	250x1,8x25 z56	10	0,690
2230076	250x2,2x25 z56	10	0,840
2230077	300x1,6x30 z56	10	0,890
2230078	300x1,8x30 z56	10	1,000
2230079	300x2,0x30 z56	10	1,110
2230080	350x2,2x30 z56	10	0,670
2230081	400x3,0x30 z56	10	0,300
2230082	450x2,8x30 z56	10	3,500
2230083	500x3,0x30 z56	10	4,640
2230084	550x3,0x30 z56	10	5,600
2230085	600x2,8x30 z56	10	6,220
2230086	600x3,5x30 z56	10	7,770

Kotúč pílový SuperSaw NW



kód	popis		
2230050	200x2,5x20 z16	10	0,250
2230051	250x3,2x30 z20	10	0,250
2230052	300x3,2x30 z24	10	0,250
2230053	350x3,6x30 z28	10	0,250

Kotúč pílový SuperSaw NWC



kód	popis		
2230058	160x2,5x20 z36	10	0,290

List na priamočiaru pílu, úchyt T



kód	popis		
226537	A) zub 4.0 mm, 8x100 mm, bal. 5ks	5	0,011
226536	B) zub 2.5 mm, 8x100 mm, bal. 5ks	5	0,011

použitie: drevo

List na priamočiaru pílu, úchyt T

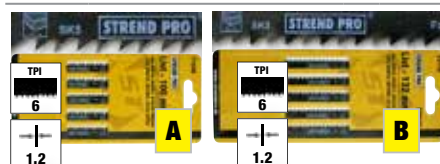

kód	popis		
226538	A) zub 4.0 mm, 8x100 mm, bal. 5ks	5	0,011
226547	B) zub 4.0 mm, 8x132 mm, bal. 5ks	5	0,011

použitie: drevo

List na priamočiaru pílu, úchyt T

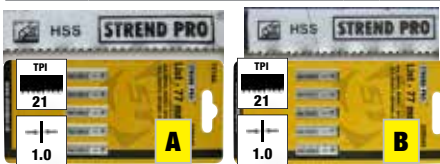

kód	popis		
226545	A) zub 1.2 mm, 6x77 mm, bal. 5ks	5	0,011
226544	B) zub 1.2 mm, 8x77 mm, bal. 5ks	5	0,011

použitie: kov, nerez, plech

List na priamočiaru pílu, úchyt T



kód	popis		
226546	zub 3 mm, 8x100 mm, bal. 5ks	5	0,011

použitie: kov, plast, plech

Kotúč pílový SuperSaw NWZ



kód	popis		
2230059	250x3,2x30 z48	10	0,400
2230060	300x3,2x30 z64	10	0,400

MAXIMÁLNY DOSAH MERANIA:

- vnútri - 30 m
- vonku - 10 m
(s použitím detektora)

- Meranie najkratšej vzdialenosti k cieľu s kontinuálnym meracím režimom.
- Režim nepriameho merania pomocou Pythagorovej vety na výpočet nedostupných miest
- Vnútoraná pamäť uchováva 20 meraní.
- Výber 2 referenčných bodov.
- Výber 5 meracích jednotiek.
- Podsvietený LCD displej.
- Ukazovateľ životnosti batérií

OBSAH BALENIA:

- Zariadenie
- 2x batérie typu AAA
- Návod na použitie



Int. kód
213795

Laser Prolaser® Beamfinder™

Laser KAPRO® 862

Prolaser®



- Automatické určenie horizontálnej a vertikálnej polohy
- Laser premieta pretínajúce sa horizontálne a vertikálne lúče
- Manuálny režim pre prácu v akomkoľvek sklone
- Vizually upozornenie ak je nerovne upevnený laser
- Uzamykací mechanizmus na ochranu počas prepravy
- Možnosť zavesenia
- 2 magnety na zadnej časti zariadenia

PRESNOSŤ:

- $\pm 0.3\text{mm/m}$

MAXIMÁLNY DOSAH LASERA:

- vnútri - 20m

TRIEDA LASERA:

- II.

BATÉRIE:

- 2x AAA (nie sú súčasťou balenia)

POUŽITIE:

- Vešanie policí a skriň
- Pokladanie podláh a dlaždíc
- Dekoračné práce

OBSAH BALENIA:

- Prenosné vrecko
- 1/4" adaptér trojnožky

Int. kód

213770

Laser KAPRO® 883N

Prolaser®, 3D All-lines



- Automatické určenie horizontálnej a vertikálnej polohy
- Zariadenie emituje 1 horizontálny 360° a 2 kolmé vertikálne 360° lúče pretínajúce sa na 4 stenách, podlahe a stropce.
- Manuálny režim pre prácu v akomkoľvek sklone
- Uzamykací mechanizmus na ochranu počas prepravy

MAXIMÁLNY DOSAH LASERA:

- vnútri - 20m
- vonku - 60m
(s použitím detektora)

POUŽITIE:

- Vešanie policí a skriň
- Pokladanie podláh a dlaždíc
- Inštalátorské práce
- Presné meranie uhlov pri montáži plotov, brán, plošín a besiedok
- Meranie sklonu schodov, zábradlia, striech atď.

OBSAH BALENIA:

- Pevné plastové puzdro
- Viacúčelový magnetický držiak
- Zameriavač

Int. kód

213703

PRESNOSŤ:

- $\pm 0.2\text{mm/m}$

TRIEDA LASERA:

- II.

BATÉRIE:

- 4x AAA

Laser KAPRO® 872S

Prolaser®, Plus



- Prekřížené horizontálne a vertikálne lúče pod uhlom 90°
- Manuálny režim pre prácu v akomkoľvek sklone
- Pevné nohy pre nastavenie uhla a výšky
- Vizually upozornenie ak je nerovne upevnený laser
- Samonivelizačný rozsah $\pm 5^\circ$

Int. kód

213518

TRIEDA LASERA:

- II.

PRESNOSŤ:

- $\pm 0.2\text{mm/m}$

MAXIMÁLNY DOSAH LASERA:

- vnútri - 20m
- vonku - 50m
(s použitím detektora)

POUŽITIE:

- Zarovňavanie dlaždíc, skriň, lišt a obrúb
- Pokladanie podláh
- Montáž dverí a okien
- Práce v domácnosti (napríklad. vešanie policí, obrázkov a iné)

OBSAH BALENIA:

- Prenosné vrecko
- 1/4" adaptér trojnožky

BATÉRIE:

- 3 AA (nie sú súčasťou balenia)

Laser KAPRO® 872G

Prolaser®, Plus



- Prekřížené horizontálne a vertikálne lúče pod uhlom 90°
- Manuálny režim pre prácu v akomkoľvek sklone
- Pevné nohy pre nastavenie uhla a výšky
- Vizually upozornenie ak je nerovne upevnený laser
- Samonivelizačný rozsah $\pm 5^\circ$

Int. kód

213774

TRIEDA LASERA:

- II.

PRESNOSŤ:

- $\pm 0.2\text{mm/m}$

MAXIMÁLNY DOSAH LASERA:

- vnútri - 20m
- vonku - 60m
(s použitím detektora)

POUŽITIE:

- Zarovňavanie dlaždíc, skriň, lišt a obrúb
- Pokladanie podláh
- Montáž dverí a okien
- Práce v domácnosti (napríklad. vešanie policí, obrázkov a iné)

OBSAH BALENIA:

- Prenosné vrecko

BATÉRIE:

- 3 AA (nie sú súčasťou balenia)

Merač Kaprometer K1

Prolaser®

- Meranie vzdialeností v miestnosti až do 30 m
- LCD displej
- Meria plochu aj objem
- Nepriame meranie pomocou Pythagorovej vety
- 2 meracie referenčné body
- Pamätové funkcie
- Presnosť $\pm 2\text{mm}/30\text{m}$
- Merací rozsah 0,5-30 m
- Rozlíšenie 0,001 m

Int. kód Vzdialenosť

2160758 max. 30 m



- Laser trieda II, 635nm
- Batérie 2x AAA
- Životnosť batérií do 5000 meraní
- Prevádzková teplota -10°C až 40°C
- Automatické vypnutie lasera 20 sekúnd

POUŽITIE:

- Rámovanie
- Podlaha
- Sadrokartóny
- Interiér

- 4 vertikálne čiaru a 1 vertikálna priečna čiara, lineárne značenie so stopom a olovnicu.
- Výškovo nastaviteľný statív a adaptér (5/8").
- Vizually upozornenie "mimo úrovne"
- 360° mikro-nastaviteľná rotácia.
- Vstavaný ochranný uzamykací mechanizmus.
- Pulzný režim pre vonkajšie použitie s detektorom (nie je súčasťou balenia).
- Presnosť: 0,2 mm / 1 m
- Samonivelizačný rozsah $\pm 2,5^\circ$
- Rozsah lasera:
- v interiéru do 10 m
- v exteriéri s detektorom do 30 m

Laser Prolaser® Beamfinder™

Int. kód
213460



- Trieda lasera: II.
- Batérie: 3x AA
- Balenie: statív, okuliare, kufrík

Príslušenstvo k zariadeniu Laser Prolaser®

Prijímač laserového lúča / Detektor

- Samonivelizačný rozsah $\pm 4^\circ$
- Vizually a zvuková výstraha pre polohu "z úrovne"
- Dosah až: - 65 "(20 m), vnútorný
- 130 "(40 m), vonku s detektorom

Int. kód
213498



Stojan Kapro kovový

Int. kód ks
2160218 24

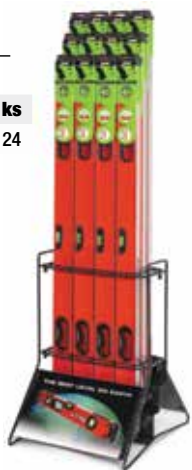

Statívy pre Laser

Int. kód Dĺžka
2160760 1.20 m
2160759 2.32 m



- Láhky statív
- s líbelou - až 1,2 metra

- Profesionálny statív s rozsahom a líbelou - až 2,32 m

Vodováha Int. kód Dĺžka

Digiman® 2160704 60 cm

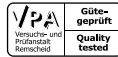

- Digitálna nivelácia: 360°
- LCD: 360° čitateľné - otočiteľný displej. Široký LED displej s LED podsvietením
- Funkcie a tlačidlá: Hold funkcia; Funkcia režimov - stupne, percentá, palce/stopy a mm/m; Pamäť na 9 nameraných hodnôt s prehliadaním; Rekalibračná funkcia; Referenčný uhol ("Falošná 0"); Funkcia zvukového signálu pri uhloch 0°, 45°, 90° s možnosťou vypnutia.
- Elektrická meracia presnosť: +/- 0,2° id 2° do 89°
- Presnosť líbely: +/- 0,5 mm/m
- Napájanie: 9 V batéria (nie je súčasťou balenia)
- Životnosť batérie: cca 8 hodín nepretržitej práce
- Automatické vypnutie: po 10 minútach
- Izolácia: v súlade so štandardmi IP54
- Dva jemne frézované plochy s magnetmi



Vodováha Exodus

- 3 ľahko čitateľné líbely (horizont, vertikál, 45°)
- Právtko pozdĺž profilu
- Spenený profil, robustné bočné gumenné nárazníky, jemný brúsený povrch.
- Presnosť: 0,5 mm/m
- Funkcia Wall Grip



Int. kód Dĺžka
2160755 600 mm
2160756 1000mm

Vodováha Int. kód Dĺžka

Digiman® 2160771 60 cm
2160772 80 cm

- Popis ako pri vodováhe 2160704
- + laserové ukazovátka – zrovnáva úroveň bodov do vzdialenosti až 50 m



Profesionálna vodováha systém OptiVision™

Patented



Int. kód Dĺžka
2160703 400mm
2160194 600mm
2160195 800mm
2160196 1000mm
2160197 1200mm
2160198 1800mm
2160209 2000mm



- 2 pevné akrylické nárazuvzdorné vialy
- OPTIVISION Red horizontálna viala vytvára vysokoviditeľnú bublinku, pre presné zameranie medzi čítagami čiarokami a optimalizuje videnie v príliš svetlom a pri nízkom svetle.
- Naklonená horizontálna viala s priamym náhľadom línie pre ľahké čítanie
- Bočné Duálne videnie vialy s červeným efektom pre čisté videnie
- Presnosť 0,5mm/m
- Spenený profil, robustné bočné gumenné nárazníky, ergonomické rukoväte, jemný brúsený povrch.

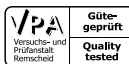

Vodováha inštalátorská

Plumbing Installation



- 2x epoxidová uzamknutá pevná akrylová líbela: 1 vertikálna líbela / 1 horizontálna líbela
- 5 značkových bodov na profile vodováhy určených pri štandardných montážach:
- 280 mm pre pripevnenie umývadla na stenu
- 150 mm pre umiestnenie vodovodnej batérie
- 75 mm pre vodovodné potrubie pod drezom
- Presnosť: 0,5 mm/m
- Tlmiace gumenné nárazníky
- Zosilnený hliníkový profil



Int. kód Dĺžka
2160757 700 mm



Vodováha DRYWALL

PlumbSite®



- Vodováha z hliníkového profilu s kužeľovými drážkami a značkovačmi pre 40 a 60 cm štandardný rozstup profilov
- Sloty pre profily s magnetmi zo vzácných zemín - vložíte a udržíte ľahko kovové profily pre rýchlu a jednoduchú manipuláciu a nastavenie
- Vyhľadávanie kovových profilov za sadrokartónovými doskami pomocou rozvrhnutých značiek na strane vodováhy
- 2 epoxidové zapustené, pevné akrylové líbely:
- 1 Plumb Site® Dual-View™ vertikálna líbela, 1 horizontálna líbela
- frézovaný povrch
- nárazu vzdorné koncové uzávery
- Presnosť: < (0,5 mm / m)



Int. kód Dĺžka
2160754 900 mm

STREND PRO® PREMIUM® Vodováha



Vodováha s magnetom

Int. kód	Dĺžka
2160706	400mm
2160707	600mm
2160708	800mm
2160709	1000mm
2160710	1200mm
2160711	1500mm
2160712	1800mm
2160713	2000mm

Vodováha bez magnetu

Int. kód	Dĺžka
2160726	200mm
2160705	400mm
2160696	600mm
2160697	800mm
2160698	1000mm
2160700	1200mm
2160699	1500mm
2160701	1800mm
2160702	2000mm



- DOŽIVOTNÁ ZÁRUKA
- PRESNOSŤ
- ODOLNÁ NÁRAZU
- UV OCHRANA
- ELEKTRONICKY TESTOVANÉ

Vodováha Topcast®

Int. kód Dĺžka
2160719 600 mm

- 2 pevné akrylické vialy
- Frézovaný povrch
- Presnosť 0,5mm/m



Stojan Kapro kovový

Int. kód ks
2160739 12



Stojan Kapro kartonový

- Pri objednávke vodováh KAPRO nad 100€ stojan zdarma

Int. kód ks
2160219 12



Držiak na stenu

univerzálny

- magnetický

Int. kód
216158



Vodováha

Vulcan

- 3 pevné nárazuvzdorné vialy
- Spevnený profil, robustné bočné gumenné nárazníky, ergonomické rukoväte, jemný brúsený povrch.
- Presnosť 0,5mm/m

Int. kód	Dĺžka
2160774	600 mm
2160775	800 mm
2160776	1200 mm
2160777	1800 mm
2160778	2000 mm

Vodováha

Optivision™ Red Torpedo

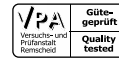

- 3 pevné akrylické nárazuvzdorné vialy
- OPTIVISION Red horizontálna viala vytvára vysokoviditeľnú bublinku
- Naklonená horizontálna viala
- Presnosť 0,5mm/m
- Spevnený profil, robustné bočné gumenné nárazníky, ergonomické rukoväte, jemný brúsený povrch.

Int. kód Dĺžka
2160773 250 mm



- Bočné Duálne videnie vialy
- 2 pevné akrylické vialy
- Epoxidovo-uchytená horizontálna viala
- Leštený povrch
- Robustná konštrukcia z liateho hliníka
- Nákovky z gumy pre absorpciu úderov.
- Presnosť 0,5mm/m

Vodováha Shark Dual-View™

Patented

Int. kód	Dĺžka
2160211	400mm
2160212	600mm
2160213	800mm

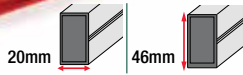
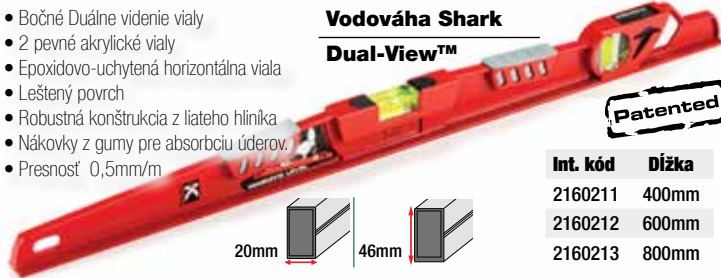

Vodováha ToolBox

Int. kód Dĺžka
2160215 250mm

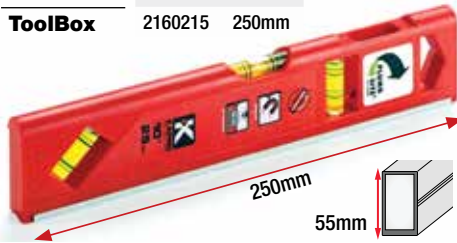

- Vhodná do boxov na náradie
- Pevný vnútorný ALU rám
- Bočné Duálne videnie vialy Dual-View™
- 3 ľahko čitateľné vialy (horizont, vertikál, 45°)
- Bočné Duálne videnie vialy
- Vyrovnávací lišta pre dlažbu a parapety
- V-drážka s magnetickým páskom

Vodováha ValueCast

Int. kód Dĺžka
2160695 250 mm



- DOŽIVOTNÁ ZÁRUKA NA LIBELU
- PRESNOSŤ
- UV OCHRANA
- ELEKTRONICKY TESTOVANÉ

Vodováha 230 mm

Int. kód Dĺžka
2160214 230mm



- Bočné Duálne videnie vialy Dual-View™
- 3 pevné akrylické vialy
- Epoxidovo-uchytená horizontálna viala
- Pevný vnútorný ALU rám
- V-drážka pre rúrky
- Silné magnety
- Presnosť 0,5mm/m

Sada vodováh, 5ks 15,20,25,32,50 mm

- Pre štandardné rozmery kovových a plastových rúr
- Pružné uloženie pre ľahké usadenie
- 2 ľahko čitateľné vialy (horizont, vertikál)



Balenie
5 ks
Int. kód
2160216



Balenie
10 ks

Int. kód
2160210

Vodováha 100 mm



- Skladacia stípková vodováha
- Úplné zatvorenie a roztvorenie
- Zaklapnutie každých 15°
- Nastaviteľný pružný pás pre nemagnetické povrchy
- 4 silné magnety pre nemagnetické povrchy
- Vhodné pre všetky stípy, rúry a značky

Vodováha Postrite[®]

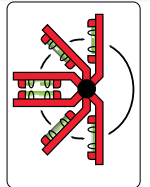

Int. kód
2160217

A) Púder

113g
226g



B) Šnúra 30m + púder 113g

Int. kód	Farba	Veľkosť
A) 2160658	červený	113g
A) 2160659	červený	226g
B) 216554	modrý	113g



Int. kód
212180

Uholník nastaviteľný

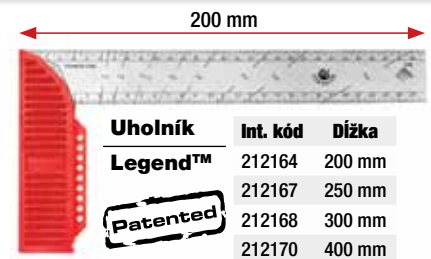

Uholník Legend™	Int. kód	Dĺžka
	212164	200 mm
	212167	250 mm
	212168	300 mm
	212170	400 mm



Int. kód
216494



Šnúra s pevným úchopom a vodováhou / 30 m

- Integrovaná rovinová viala a EXTRA rýchly navijač.
- Pevná rúčka s ergonomickým úchopom
- Výsuvná rovinová viala zasúvacia do navijača
- 6-násobne rýchlejšie navijanie X6
- Univerzálny háčik, drží na klínoch a výstupkoch, pripája sa k sadrokartónu.
- Háčikový kotviaci bod

Vodováha • MassyPrecision

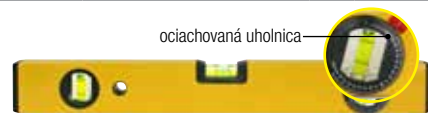

kód	popis		
2160313	400 mm	60	0,300
2160314	600 mm	60	0,367
2160315	800 mm	60	0,450
2160316	1000 mm	30	0,600
2160317	1200 mm	10	0,430
2160318	1500 mm	20	0,530

Vodováha murárska



kód	popis		
2160193	0400 mm	60	
2160169	0600 mm	20	0,450
2160170	0800 mm	20	0,600
2160171	1000 mm	1	0,600
2160172	1200 mm	1	0,750
2160173	1500 mm	1	0,800
2160174	1800 mm	1	1,100
2160175	2000 mm	1	1,200

Vodováha murárska



kód	popis		
2160101	0400 mm	1	0,500
2160102	0600 mm	1	0,600
2160103	0800 mm	1	0,800
2160104	1000 mm	1	0,900
2160539	1200 mm	1	
2160540	1500 mm	1	1,200
2160541	1800 mm	1	1,300
2160542	2000 mm	1	1,500

Lata zrovnávacia 20D4, 2-libelová



kód	popis		
2160095	1500 mm	10	1,100
2160096	1800 mm	20	1,550
2160097	2000 mm	20	1,700
2160098	2500 mm	10	2,200

Lata zrovnávacia



kód	popis		
2160082	A) 1200 mm, trapézová	6	0,900
2160083	A) 1500 mm, trapézová	20	1,100
2160084	A) 1800 mm, trapézová	6	1,300
2160085	A) 2000 mm, trapézová	20	1,400
2160086	A) 2500 mm, trapézová	6	1,800
2160091	B) 1500 mm, bez libely	20	1,350
2160092	B) 1800 mm, bez libely	10	1,600
2160093	B) 2000 mm, bez libely	20	1,700
2160094	B) 2500 mm, bez libely	10	2,200

Lata zrovnávacia 20D3, 2-libelová



kód	popis		
2160087	1500 mm	6	1,100
2160088	1800 mm	6	1,300
2160089	2000 mm	6	1,600
2160090	2500 mm	10	1,900

Uholník Alu



kód	popis		
2160661	250 mm	8	0,250
2160558	300 mm	8	0,271
2160559	350 mm	8	0,313
2160560	400 mm	8	0,333
2160662	450 mm	8	0,354
2160663	500 mm	8	0,375
2160664	550 mm	8	0,396
2160561	600 mm	6	0,417

Uholník Alu



kód	popis		
2160455	300 mm	20	0,175
2160456	350 mm	12	0,250
2160457	400 mm	12	0,347

Uholník Alu



kód	popis		
2160673	250 mm	12	0,229
2160450	300 mm	12	0,250
2160674	350 mm	12	0,271
2160675	400 mm	12	0,292
2160451	400 mm	12	1,000
2160452	500 mm	12	1,000

Uholník



kód	popis		
2160099	0300x0500 mm	12	0,500
2160100	0400x0600 mm	12	0,500

Uholník Alu



kód	popis		
2160665	250 mm	1	0,188
2160666	300 mm	1	0,208
2160667	350 mm	1	0,313
2160668	400 mm	1	0,333
2160669	450 mm	1	0,354
2160670	500 mm	1	0,375
2160671	550 mm	1	0,396
2160672	600 mm	1	0,417

Uholník Alu



kód	popis		
2160681	250 mm	1	0,208
2160682	300 mm	1	0,229
2160683	350 mm	1	0,250
2160684	400 mm	1	0,271

Uholník Alu



kód	popis		
2160676	200 mm	1	0,125
2160677	250 mm	1	0,146
2160678	300 mm	1	0,167
2160679	350 mm	1	0,208
2160680	400 mm	1	0,250

Uholník stolársky YB-Alu



kód	popis		
222626	150 mm	12	0,150
222624	200 mm	10	0,150
222631	250 mm	12	0,150
222619	300 mm	12	0,150
222074	350 mm	12	0,160
222628	400 mm	12	0,179

Uholník Alu



kód	popis		
2160453	40x1000 mm	12	0,780
2160454	40x1250 mm	12	1,000

Meter ocelový

GIAN'TOP

kód	popis		
2160750	3,0 m / 16 mm / ABS	12	1,300
2160751	5,0 m / 19 mm / ABS	12	2,250

3x vyššia životnosť / 20% hrubšia páska

Meter ocelový

GIAN'TOP Pro

kód	popis		
2160746	2,0 m / 16 mm / ABS	12	0,116
2160747	3,0 m / 16 mm / ABS	12	0,145
2160748	5,0 m / 19 mm / ABS	12	0,237
2160749	8,0 m / 25 mm / ABS	12	0,437

3x vyššia životnosť / 20% hrubšia páska / pochromované a pogumované telo

Meter ocelový, mini

GIAN'TOP

kód	popis		
2160809	2,0 m / 8 mm / pvc	1	

Meter ocelový



kód	popis		
2160638	3,0 m / 16 mm / ABS	28	0,122
2160639	5,0 m / 19 mm / ABS	42	0,150

Meter ocelový



kód	popis		
2160640	2,0 m / 13 mm / ABS	10	0,092
2160641	3,0 m / 13 mm / ABS	21	0,111
2160642	5,0 m / 19 mm / ABS	42	0,183

Meter ocelový



kód	popis		
2160636	3,0 m / 19 mm / AutoStop / magnet	28	0,144
2160637	5,0 m / 19 mm / AutoStop / magnet	42	0,233
2160717	7,5 m / 25 mm / AutoStop / magnet	42	0,183
2160718	10 m / 25 mm / AutoStop / magnet	42	0,183

Meter ocelový

GIAN'TOP

kód	popis		
2160123	02,0 m / 16 mm / AutoStop	12	0,166
2160122	03,0 m / 16 mm / AutoStop	12	0,167
2160121	05,0 m / 19 mm / AutoStop	12	0,233
2160232	07,5 m / 25 mm / AutoStop	6	0,420
2160233	10,0 m / 25 mm / AutoStop	6	0,563

Meter ocelový

GIAN'TOP

kód	popis		
2160568	2,0 m / 16 mm / magnet	12	0,116
2160569	3,0 m / 16 mm / magnet	12	0,141
2160570	5,0 m / 19 mm / magnet	12	0,216
2160571	8,0 m / 26 mm / magnet	6	0,433

Meter ocelový



kód	popis		
2160643	3,0 m / 16 mm / pvc	28	0,100
2160644	5,0 m / 19 mm / pvc	42	0,175

Pravítko ocelové



kód	popis		
222478	300 mm	1	0,067
222477	600 mm	1	0,128
222412	1000 mm	1	0,307

Meter ocelový



kód	popis		
2160148	2 m	1	0,066
2160149	3 m	1	0,083
2160150	5 m / 16 mm	1	0,150
2160151	7 m	1	0,300

Meter ocelový



kód	popis		
2160152	2,0 m	1	0,075
2160153	3,0 m	1	0,092
2160154	5,0 m	1	0,158

Meter skladací, MINI



kód	popis		
216618	plastový / 1 m	200	

Meter skladací



kód	popis		
216638	plastový / 1 m	1	0,200
216651	plastový / 2 m	1	0,300

Meter skladací



kód	popis		
216081	drevený / 1 m	1	0,056
216082	drevený / 2 m	1	0,087

Meter skladací

STREND PRO
NOVINKA

kód	popis		
216184	1 m, drevený, Class 3, CE, Presnosť: ±1 mm		
216112	2 m, drevený, Class 3, CE, Presnosť: ±1.4 mm		

METERS

Meracie pásmo, oceľ

GIANTOP



3:1



kód	popis		
2160802	15 m / 13 mm / 3:1	50	
2160803	20 m / 13 mm / 3:1	30	
2160804	30 m / 13 mm / 3:1	30	
2160805	50 m / 13 mm / 3:1	20	

Meracie pásmo, oceľ

GIANTOP



3:1



kód	popis		
2160806	30 m / 13 mm / 3:1	30	
2160807	50 m / 13 mm / 3:1	20	

Meracie pásmo, oceľ

GIANTOP



Mini

kód	popis		
2160808	1 m / 6 mm / MINI	36	

Meracie pásmo

GIANTOP



kód	popis		
2160106	20 m / 13 mm / sklolaminát	60	0,300
2160107	30 m / 13 mm / sklolaminát	60	0,400
2160108	50 m / 13 mm / sklolaminát	20	0,733

Meradlo posuvné

STREND PRO
PREMIUM



NOVINKA

kód	popis		
222294	150 mm Delenie: 0.01 mm Presnosť: ±0.03 mm		

Meradlo posuvné, Digital



kód	popis		
222946	150 mm	50	0,420

Meracie pásmo, oceľ

GIANTOP



kód	popis		
216454	20 m / 10 mm	60	0,266
216422	30 m / 10 mm	60	0,366
216579	50 m / 10 mm	30	0,600

Meracie pásmo, oceľ



kód	popis		
216074	20 m	10	0,700
216577	30 m	20	0,550
216578	50 m	10	0,900

Uholník nastaviteľný

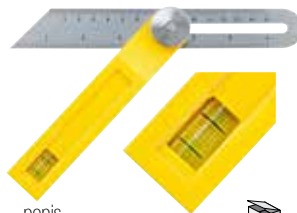

kód	popis		
222653	200 mm	12	0,133

Koliesko meracie

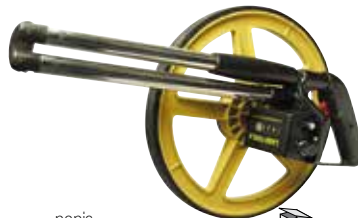

kód	popis		
216214	krokovacie	4	0,200

Meradlo posuvné

STREND PRO
PREMIUM



NOVINKA

kód	popis		
222747	150 mm, digitálny, Delenie: 0.05 mm Presnosť: ±0.05 mm		

Meradlo posuvné



kód	popis		
222693	150 mm	10	0,320
222680	200 mm	10	0,380



Nádržka do vodováhy, plastová



kód	popis		
216708	so skrutkou	50	0,040

Vodováha hadicová



so zátkou

kód	popis		
216574	10 m	20	1,000
216844	15 m	10	1,500

Vodováha hadicová



kód	popis		
216852	20 m	50	

Škármer Expert®



kód	popis		
212222	0.04-1 mm, metrické	1	

Hladítko, huba Soft



PLAST



kód	popis		
216882	260x120x22 mm	1	0,100

Hladítko, huba Porex



PLAST



kód	popis		
216883	260x120x22 mm	1	0,100

Hladítko, huba



PLAST



kód	popis		
216525	260x120x40 mm / German	1	0,100

Hladítko, huba Hydro



PLAST



kód	popis		
216558	260x120x30 mm	1	0,100

Hladítko, špongia



PLAST



kód	popis		
216885	260x120x18 mm	1	0,100

Hladítko, molitan



PLAST



kód	popis		
216409	260x120x22 mm / Soft	1	0,100

Hladítko, guma



PLAST



kód	popis		
216884	260x120x08 mm	1	0,100
2160005	náhradná guma 250x130 mm	48	0,100

Hladítko, guma Soft



PLAST



kód	popis		
216591	260x120x08 mm	1	0,100

Hladítko, guma



PLAST



kód	popis		
216629	260x120x08 mm / Hardyx	1	0,100

Hladítko, plst' biela



PLAST



kód	popis		
216443	260x120x08 mm	1	0,100

Hladítko, plst', rúčka plast



kód	popis		
2160350	140 x 280 x 10 mm, plst' hnedá	12	0,270

Hladítko, huba, rúčka plast



kód	popis		
216950	280x140 mm	10	0,254
216949	náhradná špongia 10 mm	24	0,150

Hladítko, molitan, rúčka plast



kód	popis		
216943	280x140/15 mm molitan žltý rezaný	40	0,250

Hladítko, molitan, rúčka plast



kód	popis		
216790	280x140x30 mm molitan biely rezaný	40	0,275

Hladítko, špongia, rúčka plast



kód	popis		
216315	280x140x10mm	40	0,375

Hladítko, špongia, rúčka plast



kód	popis		
216742	280x140x25 mm	12	0,270
216944	náhradná špongia 30 mm	1	0,100

Hladítko, huba, rúčka plast



kód	popis		
2160517	250x130x20 mm	1	0,100

Hladítko, huba, rúčka plast



kód	popis		
2160516	250x130x09 mm	1	0,100

Hladítko gumové, bez držiaka



kód	popis		
2160790	250x110x10 mm	12	

Hladítko špongia, bez držiaka

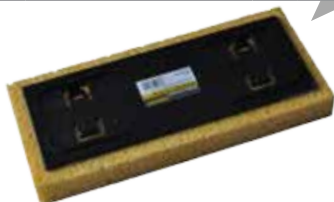

kód	popis		
2160792	270x120x30 mm	12	

Hladítko ABS, Duren



kód	popis		
216907	250x130x20 mm; rúčka plast	1	
216584	280x140x20 mm; rúčka plast	1	

Hladítko ABS, rúčka plast



kód	popis		
2160496	270x130 mm, zub. 06 mm	1	0,100
2160497	270x130 mm, zub. 08 mm	1	0,100
2160498	270x130 mm, zub. 10 mm	1	0,100

Plst' náhradná



kód	popis		
216327	biela, 240x140 mm	50	0,110
2160206	biela, 270x130x05 mm	48	0,100
2160014	biela, 270x130x10 mm	48	0,121
216261	hnedá, 240x140 mm	50	0,114

Držiak na hladítko, plastové

UNI SYSTÉM



kód	popis		
2160789	220x68 mm	12	

Hladítko, EVA, bez držiaka



kód	popis		
2160791	270x120x8 mm	12	

Hladítko, plst' hnedá



kód	popis		
216385	275x135x10 mm	12	0,400

Hladítko huba rohová



kód	popis		
2160050	350x50x50x50 mm	1	

Hladítko duroplast, biely



kód	popis		
216900	280x140 mm	1	
216901	400x180 mm	1	

Hladítko plastové



kód	popis		
216887	400x180 mm	1	0,360
216096	400x180 mm, vyztužené	1	0,370

Hladítko špongia, bez držiaka



kód	popis		
2160793	270x120x30 mm	12	

Hladítko filcové, bez držiaka



kód	popis		
2160794	250x120x20 cm	12	

Hladítko ABS



kód	popis		
216250	260x120 mm, 2 mm	12	0,240
216252	280x140 mm, 3 mm	12	0,280

Hladítko ABS, plastové



kód	popis		
2160511	250x130 mm, ABS, plast	1	0,100

Hladítko polyuretánové, PU



kód	popis		
216516	140x280 mm	10	0,206
216947	180x320 mm	12	0,310
216948	200x350 mm	12	0,540

Hladítko polystyrénové



kód	popis		
216145	140x0248 mm	1	
216147	140x0500 mm	1	
216148	140x0700 mm	1	
216987	130x1000 mm	1	

HLADÍTKA / BRICKLAYING TROWEL

Hladítko, mäkká rúčka **STREND PRO**® PREMIUM

NEREZ



kód	popis		
216991	zub 4x4 / 270x130x0,7 mm	1	0,100
216992	zub 6x6 / 270x130x0,7 mm	1	0,100
216993	zub 8x8 / 270x130x0,7 mm	1	0,100
216995	zub 10x10 / 270x130x0,7 mm	1	0,100
216996	zub 12x12 / 270x130x0,7 mm	1	0,100

Hladítko, mäkká rúčka **STREND PRO**® PREMIUM

NEREZ



kód	popis		
216990	270x130x0,7 mm	1	0,100

Hladítko, rúčka plast **STREND PRO**® PREMIUM

NEREZ



kód	popis		
2160116	280x120 mm, zub 04 mm	12	0,360
2160114	280x120 mm, zub 06 mm	12	0,358
2160115	280x120 mm, zub 08 mm	12	0,355
2160119	280x120 mm, zub 10 mm	12	0,350

Hladítko, rúčka drevo **STREND PRO**® PREMIUM

NEREZ



kód	popis		
216880	380x130x0,7 mm	1	0,100
216881	480x130x0,7 mm	1	0,100

Hladítko, rúčka drevo **STREND PRO**® PREMIUM

NEREZ



kód	popis		
216939	480x130 mm	10	0,780

Hladítko, ocelové, rúčka drevo



kód	popis		
2160142	480x130 mm	6	0,556

Hladítko, rúčka drevo



kód	popis		
216264	280x130 mm, e04 / nerez	12	0,358
216263	280x130 mm, e06 / nerez	12	0,353
2160202	280x130 mm, e08 / nerez	12	0,350
216265	280x130 mm, e10 / nerez	12	0,341
2160203	280x130 mm, e10 / nerez	12	0,400
2160361	280x130 mm, e04 / ocel	12	0,363
2160190	280x130 mm, e06 / ocel	12	0,360
2160200	280x130 mm, e08 / ocel	12	0,357
2160201	280x130 mm, e10 / ocel	12	0,353

Hladítko, rúčka drevo



kód	popis		
216524	280x130 mm / ocel	12	0,348
216053	280x130 mm / nerez	12	0,353

Hladítko, rúčka plast



kód	popis		
2160204	280x130 mm, ocel	12	0,370
216938	280x130 mm, nerez	12	0,373

Hladítko nerezové, rúčka plast



kód	popis		
216734	280x130/04 mm	12	0,288
216735	280x130/06 mm	12	0,285
216736	280x130/08 mm	12	0,283
216737	280x130/10 mm	12	0,280
216445	280x130/12 mm	12	0,350

Hladítko nerezové, rúčka plast



kód	popis		
216230	280x130 mm, rovné	12	0,319

Hladíto ocelové, rúčka plast



kód	popis		
216816	280x130 mm, zub 04 mm	1	0,330
216812	280x130 mm, zub 06 mm	12	0,320
216817	280x130 mm, zub 08 mm	12	0,310
216818	280x130 mm, zub 10 mm	12	0,300

Hladítko ocelové, rúčka plast



kód	popis		
216815	280x130 mm	12	0,330

Sito prehadzovacie

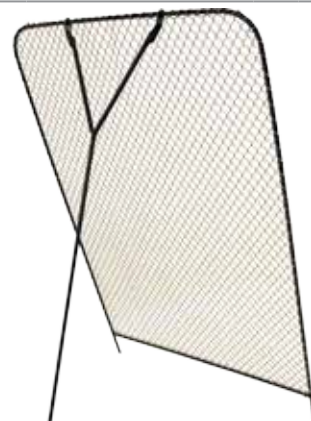

kód	popis		
217243	08 mm, L-1 m	5	7,000
217896	10 mm, L-1 m	5	6,700
217596	15 mm, L-1 m	5	6,300
217597	20 mm, L-1 m	5	6,000

Ohrablo na maltu



kód	popis		
216061	bez násady	10	0,800
216940	s násadou	1	0,900

Drážkovač na Ytong

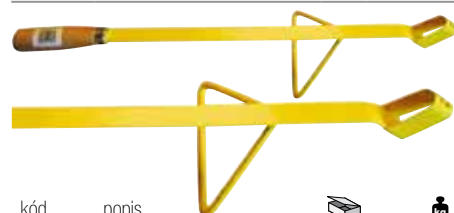

kód	popis		
216908	drevená rúčka	1	0,750

Struhadlo na polystyrén



kód	popis		
2160883	400x180 mm, plastové	1	

Struhadlo na polystyrén



kód	popis		
216848	400x180 mm, drevené	1	

Hladítko brusné na polystyrén



kód	popis		
2160880	275x135 mm / zrnitosť 16	1	

Hladítko brusné na polystyrén



kód	popis		
2160881	353x183 mm, bez papiera	1	
2160879	400x180 mm, bez papiera	1	
2160882	553x278 mm, bez papiera	1	

Hladítko brusné



kód	popis		
216984	350x160 mm; s papierom	1	0,100

Škrabák mrežový



kód	popis		
2160811	450x90x30 mm	1	

Škrabák mrežový



kód	popis		
2160329	290x150x22 mm	18	0,833

Škrabák mrežový, so zúbkami

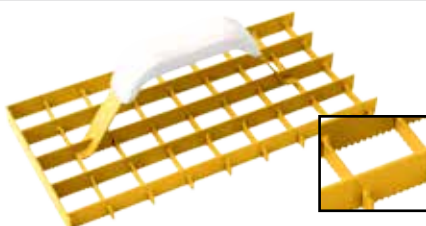

kód	popis		
216140	290x150x22 mm, so zúbkami		

Škrabák na staré omietky



kód	popis		
216559	plastové, plech	10	0,620

Škrabak



kód	popis		
216166	250x140 mm		

Škrabak na Ytong



kód	popis		
2160510	260x85 mm	1	0,515

Škrabák na Ytong



kód	popis		
216847	450x90 mm	10	0,300

Držiak na brúsnu mriežku



kód	popis		
2160208	100x225 mm	12	0,207

Držiak na brúsnu mriežku



kód	popis		
216135	80x230 mm	12	0,240

Držiak na brúsnu mriežku



kód	popis		
2160207	105x210 mm	12	0,212

Držiak brúsnej mriežky



kód	popis		
216201	160x085 mm	100	0,170
216202	210x105 mm	100	0,238

Brúsna mriežka



kód	popis		
243418	115x290 mm, z080	10	0,260
243419	115x290 mm, z100	10	0,240
243420	115x290 mm, z120	10	0,220
243421	093x290 mm, z080	10	0,070
243422	093x290 mm, z100	10	0,095
243423	093x290 mm, z120	10	0,190

Mriežka KONNER S80



kód	popis		
243480	93x290 mm, G080	5	0,161
243481	93x290 mm, G100	5	0,140
243482	93x290 mm, G120	5	0,116
243483	115x290 mm, G080	5	0,119
243484	115x290 mm, G100	5	0,110
243485	115x290 mm, G120	5	0,110

Hoblík na sadrokartón



kód popis
212429 so zarezávačom hrán

Náramok magnetický



kód popis
216640 na zápästie

Držiak magnetický



kód popis
222919 na zápästie / na skrutky, klince... 1 0,170

Pilník na sadrokartón



kód popis
227507 6.6x216 mm

Rašpľa na sadrokartón



kód popis
227003 250x16 mm

Rašpľa na sadrokartón a drevo



kód popis
227016 060x40 mm

Rašpľa na sadrokartón a drevo



kód popis
227015 250x40 mm

Súprava na škárovanie



kód popis
216667

Sada škrabiek na opravu škár



kód popis
2160797 4x silikónové čepele 10 0,133

Rašpľa na sadrokartón a drevo



kód popis
227017 140x40 mm

Rašpľa na sadrokartón a drevo

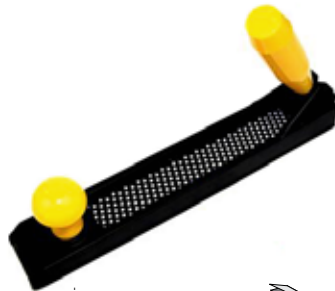

kód popis
227168 250x40 mm

Rašpľa na sadrokartón



kód popis
227014 250x40 mm

Rašpľa náhradná



kód popis
227005 060x40 mm

Rašpľa náhradná



kód popis
227007 140x40 mm

Rašpľa náhradná



kód popis
227006 250x40 mm



Stierka guma/plast 2v1



kód	popis		
2160782	160x180 mm / 8 mm	20	0,070

Stierka oceľová



kód	popis		
2160784	175 mm / 8 mm	20	0,100

Stierka zubová, drevená rúčka



kód	popis		
2160534	85x250 mm, oceľ	12	0,155

Stierka nerezová, fasádna



kód	popis		
2160321	150 mm, E08 mm	10	0,133

Stierka nerezová, fasádna



kód	popis		
2160323	400 mm	6	0,160
2160324	600 mm	6	0,433

Stierka nerezová, plastová rúčka



kód	popis		
216960	250 mm	1	0,291

Stierka nerezová, plastová rúčka



kód	popis		
2160621	200 mm	1	0,223
2160622	250 mm	1	0,253
2160623	300 mm	1	0,290
2160624	350 mm	1	0,322

Sada stierok, plastové



kód	popis		
2160634	3ks / 38-76-152 mm	1	0,131

Stierka plastová



kód	popis		
2160629	038 mm	1	0,016
2160630	076 mm	1	0,028
2160631	101 mm	1	0,049
2160632	127 mm	1	0,056
2160633	152 mm	1	0,064

Stierka plastová



kód	popis		
2160134	150 mm	25	0,026
2160186	250 mm		0,080

Stierka plastová, zubkovaná



kód	popis		
2160135	200 mm	10	0,060

Stierka gumová, drevená rúčka



kód	popis		
216513	200 mm	12	0,120
216226	250 mm	1	
216227	300 mm	12	0,262



Stierka oceľová York®



kód	popis		
216235	030 mm	10	0,070
216223	040 mm	10	0,072
216232	050 mm	10	0,079
216224	060 mm	10	0,082
216209	070 mm	10	0,090
216212	080 mm	10	0,095
216168	090 mm	10	0,110
216210	100 mm	10	0,113
216183	110 mm	10	0,120
216211	120 mm	10	0,130
216260	140 mm	10	0,135

Stierka oceľová, drevená rúčka



kód	popis		
216645	030 mm	12	0,045
216237	040 mm	12	0,050
216341	050 mm	12	0,055
216343	060 mm	12	0,060
216342	070 mm	12	0,063
216335	090 mm	12	0,066
216336	100 mm	12	0,068
216647	120 mm	12	0,075
216648	130 mm	12	0,078

Stierka oceľová, drevená rúčka



kód	popis		
216865	030 mm	12	0,070
216866	040 mm	12	0,075
216867	050 mm	12	0,081
216868	060 mm	12	0,083
216869	070 mm	12	0,089
216870	080 mm	12	0,095
216871	090 mm	12	0,102
216872	100 mm	12	0,105
216873	125 mm	12	0,112

Stierka nerezová, plastová rúčka



kód	popis		
2160613	025 mm	1	0,063
2160614	040 mm	1	0,067
2160615	050 mm	1	0,071
2160616	060 mm	1	0,079
2160617	080 mm	1	0,079
2160618	100 mm	1	0,088
2160619	120 mm	1	0,100
2160620	150 mm	1	0,116

Stierka nerezová



kód	popis		
2160783	100 mm / 8 mm	20	0,100

Stierka nerezová, plastová rúčka



kód	popis		
2160625	038 mm	1	0,052
2160626	076 mm	1	0,058
2160627	114 mm	1	0,063
2160628	150 mm	1	0,072

Stierka oceľová, plastová rúčka



kód	popis		
216514	040 mm	1	0,080
216562	050 mm	1	0,100
216566	080 mm	1	0,103
216565	100 mm	1	0,108
216619	125 mm	1	0,129
216058	150 mm	1	0,129

Stierka nerezová, plastová rúčka



kód	popis		
216858	030 mm	10	0,100
216828	040 mm	10	0,105
216857	050 mm	10	0,110
216859	060 mm	10	0,120
216860	080 mm	10	0,130
216861	090 mm	10	0,140
216862	100 mm	10	0,150
216863	125 mm	10	0,160
216644	150 mm	10	0,180

Stierka na sadrokartón, nerezová



kód	popis		
2160325	150 mm, plastová rúčka	12	0,285
2160326	200 mm, plastová rúčka	12	0,225

Stierka nerezová, maliarská



kód	popis		
2160155	200 mm	60	0,130
2160156	250 mm	60	0,183
2160157	300 mm	12	0,208

Multifunkčná stierka, nerezová



kód	popis		
217845	50 mm	10	0,08

Sada stierok, plastová rúčka



kód	popis		
216823	3 dielna, oceľ	4	0,810

Sada stierok, drevená rúčka



kód	popis		
216941	3 dielna, oceľ	10	0,140

Sada stierok, nerezová



kód	popis		
2160327	50-80-100-120 mm	20	0,096

Sada stierok, plast



kód	popis		
2160328	50-80-100-120 mm	20	0,055

Lyžica murárska, drevená rúčka



kód	popis		
216470	160x130 mm, brúsená oceľ	1	
216824	180x130 mm, brúsená oceľ	1	

Lyžica murárska, drevená rúčka



kód	popis		
216791	160x130 mm, oceľ	12	0,210
216010	180x130 mm, oceľ	12	0,260
216419	200x140 mm, oceľ	12	0,290

Lyžica murárska, drevená rúčka

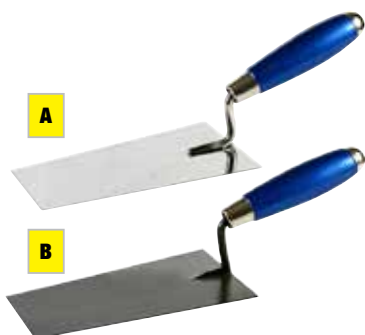

kód	popis		
2160572	A) 120 mm, nerez	12	0,173
2160573	A) 140 mm, nerez	12	0,191
216198	A) 160 mm, nerez	12	0,237
216192	A) 180 mm, nerez	12	0,290
216062	A) 200 mm, nerez	12	0,310
216935	B) 160 mm, oceľ	12	0,233
216936	B) 180 mm, oceľ	12	0,296
216469	B) 200 mm, oceľ	48	0,320

Lyžica murárska, plastová rúčka



kód	popis		
216215	160 mm, oceľ	12	0,224
216161	180 mm, oceľ	12	0,289
216825	200 mm, oceľ	12	0,310

Lyžica pokrývačská, drevená rúčka



kód	popis		
216841	140 mm, nerez	12	

Lyžica murárska, drevená rúčka



kód	popis		
216222	140 mm, nerez	12	
216217	160 mm, nerez	12	

Lyžica špárovacia, drevená rúčka



kód	popis		
216694	08x185 mm, nerez	48	0,110
216845	10x185 mm, nerez	48	0,130
216628	12x185 mm, nerez	12	0,150

Lyžica kútová, drevená rúčka



kód	popis		
216125	80x60x60 mm, nerez	12	0,190

Lyžica rohová, drevená rúčka



kód	popis		
216126	80x60x60 mm, nerez	12	0,180

Lyžica vymazávacia, drevená rúčka



kód	popis		
216838	040 mm, nerez	12	0,150
216725	060 mm, nerez	12	0,150
216471	080 mm, nerez	12	0,170
216434	100 mm, nerez	12	0,180
216218	120 mm, nerez	12	0,195

Naberačka murárska



kód	popis		
2160884	160 mm, oceľ, rúčka drevo	1	
2160885	180 mm, oceľ, rúčka drevo	1	

Naberačka murárska



kód	popis		
216063	160 mm, oceľ, rúčka drevo	10	0,357
216153	180 mm, oceľ, rúčka drevo	60	0,383
216248	215 mm, oceľ, rúčka drevo	60	0,500

Naberačka murárska



kód	popis		
2160492	160 mm, pozinkovaná, rúčka drevo	1	0,300
2160493	180 mm, pozinkovaná, rúčka drevo	1	0,400

Naberačka murárska na palicu



kód	popis		
216174	A) 215 mm, oceľová		
2160494	B) 215 mm, pozinkovaná	1	0,422

Naberačka murárska



kód	popis		
216013	plastová, 165 mm	1	0,214
216878	plastová, 180 mm	1	0,214

Naberačka murárska



kód	popis		
2160411	215 mm, plastová s tulejou	1	0,232

Maltovník obdĺžnikový



kód	popis		
216066	45 lit., v20 x š38.5 x d68.5 cm	240	1,690
216117	60 lit., v28 x š38.5 x d69 cm	240	1,925
216361	80 lit., v30 x š49 x d79 cm	120	2,750

Maltovník okrúhly



kód	popis		
216347	40 lit., Ø 55 x v27 cm	360	1,910
216348	65 lit., Ø 55 x v35 cm	100	2,120
216349	90 lit., Ø 65 x v38 cm	100	2,510

Vedro murárske



kód	popis		
254205	5 lit	1	0,273
254204	10 lit	1	0,460
254644	12 lit	1	0,470
254063	15 lit	1	0,727
254064	20 lit	1	0,775

Vedro murárske s výlevkou



kód	popis		
254335	12 lit	1	0,590
254336	20 lit	1	0,400

Nádobka murárska



kód	popis		
2160635	254 mm / gumový pás+držiak	1	

Nádoba murárska



kód	popis		
2160133		20	0,300

Nádoba na sádku



kód	popis		
217846	152x52 mm	100	0,054
217036	120x93 mm	10	0,064

Stojan murársky



kód	popis		
216402	680x554 mm, H-815-1315 mm	1	6,000

Kladka BRANO Z500

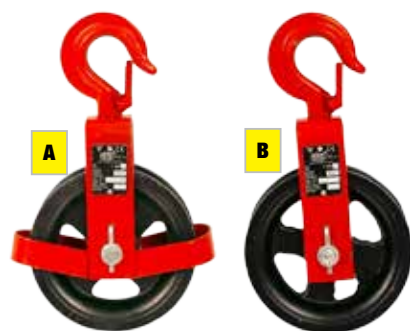

kód	popis		
112075	A) 0,5 ton, Z500 A	1	1,200
112073	B) 0,5 ton, Z500 B	1	1,200

Kladka BRANO Z500

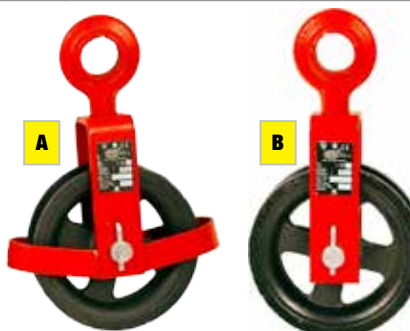

kód	popis		
112076	A) 0,5 ton, Z500 C	1	1,200
112074	B) 0,5 ton, Z500 D	1	1,200

Kladka BRANO



kód	popis		
112079	0,5 ton, s reťazou	1	1,200

Kladka liata BRANO



kód	popis		
112054	030 mm	1	0,030
112055	040 mm	1	0,040
112056	050 mm	1	0,050
112057	060 mm	1	0,060
112123	070 mm	1	0,070
112109	080 mm	1	0,080
112112	090 mm	1	0,090
112111	100 mm	1	0,100
112122	120 mm	1	0,120

Rezač na PVC trúbky

GIAN'TOP

kód	popis		
229533	rozsah 6-42 mm	1	0,500
222894	čepel náhradná	200	

Rezač na trúbky PVC

GIAN'TOP

kód	popis		
229545	rozsah do 42 mm, vysoká kvalita 3-krát dlhšia životnosť	10	0,490
222893	čepel náhradná	200	

Rezač na trúbky PVC

GIAN'TOP

kód	popis		
229532	rozsah do 75mm, vysoká kvalita 3-krát dlhšia životnosť	1	0,100
222898	čepel náhradná	200	

Rezač na trúbky PVC

GIAN'TOP

kód	popis		
229632	rozsah do 42mm, nabíjateľné, automatická rezačka	50	1,600

Rezač na trúbky PVC

GIAN'TOP

kód	popis		
229531	rozsah do 42mm vymeniteľná čepel	1	0,500
222902	čepel náhradná	200	

Križik na obklad



kód	popis		
2160331	02,5 mm, 200 ks	100	0,050
2160332	03,0 mm, 150 ks	100	0,050
2160333	04,0 mm, 100 ks	50	0,050
2160334	05,0 mm, 100ks	50	0,050

Klinky na obkladačky



kód	popis		
222105	0-8 mm, 30 ks	30	0,029
222106	0-6 mm, 100 ks	100	0,053

Zipsovacie dvere



kód	popis		
2170437	<ul style="list-style-type: none"> fólia na dvere so zipsom čistý prehľadný materiál pre vchody do šírky 1 metra 	1	0,416

Podložka pojazdná



kód	popis		
2160686	na kolená	1	1,916

Sada na opravu podláh



kód	popis		
2160796	Tavná spájkovačka 2xAA 2x klín 1x čistiaci špongia 12x farebná tyčinka z plastu	1	0,333

Škárovacie vrečko



kód	popis		
2170435	s plastovou špičkou	1	0,080

Škárovacie vrečko



kód	popis		
2170436	s kovovou špičkou	1	0,130
2170442	hrot náhradný, kovový	1	0,010

Savá zakrývacia fólia, plstená



kód	popis		
2170440	L-05m, 300g/m ² , 1000mm	1	1,580
2170441	L-10m, 300g/m ² , 1000mm	1	6,000
2170438	L-25m, 280g/m ² , 1000mm	1	7,000
2170439	L-50m, 280g/m ² , 1000mm	1	14,000

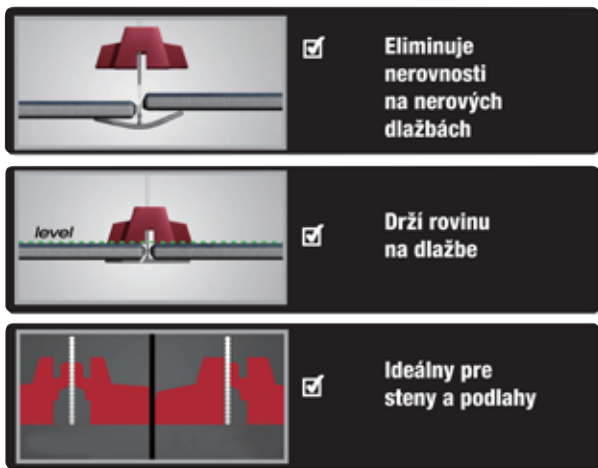

Sada nivelačná



kód	popis		
2160690	• kliešte nivelačné • 100ks medzerník • 100ks adaptér	6	1,166

Kliešte nivelačné



kód	popis		
229903	na vyrovnávanie podláh	1	0,500

Adaptér prítlačný



kód	popis		
2160688	plastový • na vyrovnávanie podláh	100	0,233

Medzerník pod obklad



kód	popis		
2160687	75x11x1,5 mm / plast • na vyrovnávanie podláh	100	0,175

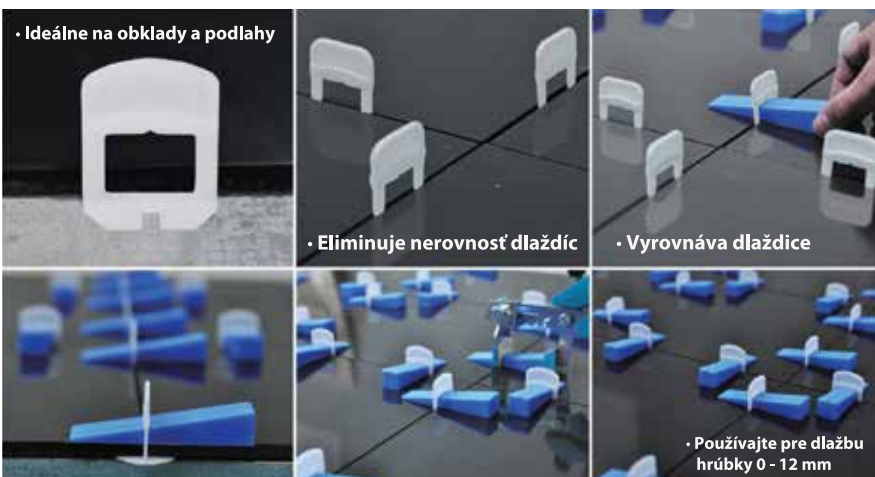

Sada nivelačná



kód	popis		
2160745	• kliešte nivelačné • 100ks medzerník • 100ks klinok	6	1,000

Kliešte nivelačné na kliny



kód	popis		
229955	na vyrovnávanie podláh	6	0,458

Klin nivelačný



kód	popis		
2160786	100x21x20 mm • na vyrovnávanie podláh	100	0,800

Lámacie kliešte



kód	popis		
229904	200 mm, s pružinou špeciálne kliešte na lámánie, tvárovanie a zväčšovanie otvorov keramických obkladov a dlaždíc. Leštená hlava.	1	0,200

Medzerník pod obklad



kód	popis		
2160787	1 mm	100	0,275
2160788	2 mm	100	0,300
• na vyrovnávanie podláh			

Čistič škár



kód	popis		
2160685	210 mm	1	0,166
2160730	náhradná čepeľ	1	0,138



Sekáč špicatý SDS+

kód	popis		
233418	250 mm	1	0,245

Sekáč špicatý SDS-Max

kód	popis		
233425	280x18 mm	1	0,500
233426	400x18 mm	1	0,737
233427	600x18 mm	1	1,160

Sekáč plochý SDS-Max

kód	popis		
233428	280x18x25 mm	1	0,520
233429	400x18x25 mm	1	0,762
233431	400x18x50 mm	1	0,840
233430	600x18x25 mm	1	1,200

Sekáč plochý SDS+

kód	popis		
233419	250x20 mm	1	0,255
233420	250x40 mm	1	0,290
233421	250x50 mm	1	0,315
233422	165x75 mm	1	0,310

Sekáč žliabkovací SDS+

kód	popis		
233423	250x22 mm	1	0,300

Sekáč žliabkovací s krídelkami

kód	popis		
233424	250x22 mm / SDS+	1	

Sekáč plochý s chráničom, plast

kód	popis		
233441	200 mm	1	
233203	250 mm	1	
233173	300 mm	1	

Sekáč špicatý

kód	popis		
233375	300 mm / šesthranný	1	

Sekáč plochý

kód	popis		
233092	150x13 mm	1	
233241	200x19 mm	1	
233106	250x19 mm	1	
233492	300x19 mm	1	

Sekáč plochý s chráničom, plast

kód	popis		
233334	250x02 mm	1	0,100
233335	300x05 mm	1	0,666
233336	350x08 mm	1	0,675

Sekáč špicatý s chráničom, plast

kód	popis		
233331	250x19 mm	1	0,430
233332	300x18 mm	1	0,500
233333	350 mm	1	0,500

Sekáč plochý s chráničom, Profi

kód	popis		
233266	150 mm	12	0,233
233267	200 mm	12	0,361
233174	250 mm	12	0,444
233264	300 mm	36	0,556
233308	350 mm	36	0,625

Sekáč špicatý s chráničom, Profi

kód	popis		
233310	250 mm	12	0,410

Sekáč plochý, Cr-V60

kód	popis		
233348	150x17 mm	10	0,180
233349	200x23 mm	10	0,380
233350	250x23 mm	10	0,470
233352	350x23 mm	5	0,640
233353	400x23 mm	5	0,740

Sekáč plochý

kód	popis		
233150	150 mm	48	0,350
233151	200 mm	60	0,267
233152	250 mm	48	0,433
233189	300 mm	60	0,517

CHISELS AND PUNCHERS

Sada sekáčov a priebojníkov



kód	popis		
234105	3x sekáč zámočnícky 2x priebojník 1x rýsovací ihla 6x dierovač	5	0,720

Sada priebojníkov a sekáčov



kód	popis		
233369	6x sekáč zámočnícky 3x jamkar 3x dierovač	1	3,660

Sada priebojníkov • 8 dielna



kód	popis		
234106	8 dielna 4x dierovač chrómový 4x dierovač mosadzný	20	0,280

Sada výsečníkov



kód	popis		
234100	3, 4, 5, 6, 7, 8, 10, 11, 12 mm	12	0,470

Sady priebojníkov, 6 dielna



kód	popis		
233370	A) sada sekáčov, jamkovačov 2x sekáč plochý / 1x sekáč krížový / 1x značkovač / 2x jamkovač	20	0,210
234103	B) sada jamkovačov 5x jamkovač 1x120, 2x120, 3x120, 4x120 mm 1x dierovač 4x120 mm	20	0,500
234102	C) sada priebojníkov 2,5x150; 3,5x150; 4,5x150; 6x150; 8x150; 10x150 mm	20	0,725

Sada sekáčov a jamkovačov



kód	popis		
212762	6 dielna 1x sekáč plochý / 1x sekáč krížový / 2x značkovač / 2x jamkovač	1	0,400

Sada sekáčov a priebojníkov



kód	popis		
233371	3x sekáč zámočnícky 1x priebojník 2x jamkar 1x dierovač	10	0,750

Sada jamkovačov



kód	popis		
234104	4 dielna 1/23"; 1/16"; 3/32"; 1/8"	10	0,230

Razidlá Čísla



kód	popis		
222546	03 mm	60	0,320
222547	04 mm	50	0,330
222005	05 mm	30	0,440
222027	06 mm	30	0,570
222545	08 mm	20	0,710
222708	10 mm	1	1,300
222709	12 mm	12	1,880

Razidlá Abeceda



kód	popis		
222002	03 mm	20	0,300
222064	04 mm	5	1,020
222400	05 mm	5	1,300
222066	06 mm	10	1,700
222834	10 mm	5	4,060
222070	12 mm	1	1,500

Sada dlát



kód	popis		
233120	4 dielna	40	0,400

Sada pinziet



kód	popis		
213117	pre jemnú mechaniku	1	0,140

REZAČKY / CUTTER TILE

Rezačka dlažby TT™ PROFI ****

*Designed
and made
in Italy*



Systém rýchleho štartu
Bežec je vybavený pružinou, ktorá drží
rukoväť stále pripravenú k použitiu.

ŠTRUKTÚRA

Silné telo vyrobené z ťahaného hliníkového profilu,
pre zabezpečenie odolnosti a nízkej hmotnosti rezačky.

BEŽEC

Bežec je z hliníka, vybavený dvoma guľčkovými
ložiskami pre perfektné klzanie a špičkovú presnosť



Tlačný rezací systém

PRACOVNÝ STÔL

V tvarovaných a podložných doskách s
reznou líniou z nerez.



NASTAVITELNÁ PODPORA
PRE MULTI-REZY

100%
ALUMINIUM

kód	popis		
212632	630 mm, diagonálny rez 44x44 cm	1	9,000
212631	830 mm, diagonálny rez 58x58 cm	1	12,000
212625	1030 mm, diagonálny rez 72x72 cm	1	13,600
rezná hrúbka: 5-15 mm; rezný kotúč: Ø 16x6x1,5 mm			
212633	Sada kolieska do rezačky	1	0,032

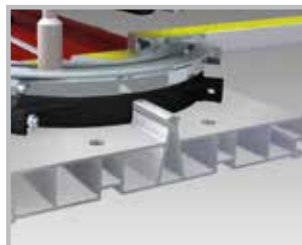
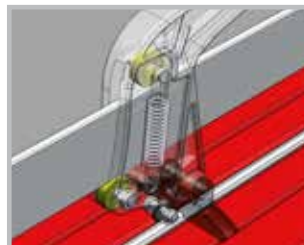

Rezačka dlažby Industrial ***



kód	popis		
212911	600 mm / 0840x300x25 mm	1	15,000
212913	750 mm / 0990x200x25 mm	1	17,000
212918	900 mm / 1140x300x25 mm	1	19,000

STAVBA

Rezačka dlažby UltraPro **



kód	popis		
212907	600 mm	1	16,400
212908	750 mm	1	19,000
212910	900 mm	1	21,300
219756	náhradné koliesko	250	0,032

Rezačka dlažby Profi



kód	popis		
212976	300 mm	6	1,830
212973	400 mm	6	2,100
212134	500 mm	3	4,330
212661	600 mm	3	4,660
219751	náhradné koliesko / 15x6 mm	250	0,020

Rezačka dlažby



kód	popis		
216821	400 mm	1	9,000
216822	500 mm	1	11,500
216826	600 mm	2	13,500
219759	náhradné koliesko	300	0,040

Rezačka dlažby s vykružovačom

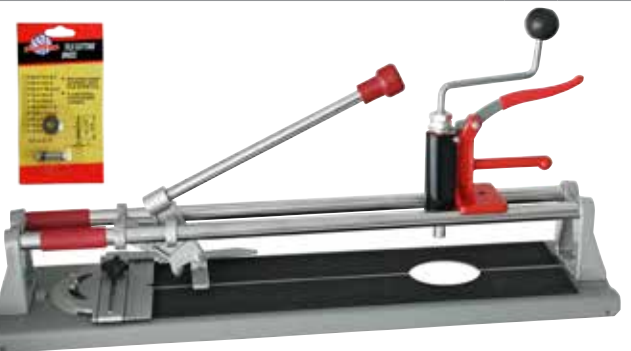

kód	popis		
216397	400 mm	6	7,000
216703	500 mm	3	6,330
216663	600 mm	3	7,000
219750	náhradné koliesko / 16x6 mm	250	0,020

Rezačka dlažby s ložiskom



kód	popis		
212979	MT516-2 • 400 mm	1	5,250
212588	MT520-2 • 500 mm	3	5,750
212592	MT524-2 • 600 mm	4	6,250
219752	náhradné koliesko / 22x6 mm	250	0,020

Rezačka obkladu



kód	popis		
216077	MB100	12	0,460

Rezačka dlažby



kód	popis		
212551	600 mm, bez vykružovača	2	8,000
219753	náhradné koliesko / 22x11 mm	250	0,010
212598	650 mm, s vykružovačom	2	8,650
219753	náhradné koliesko / 22x11 mm	250	0,010
212601	650 mm, bez vykružovača	2	7,500
219752	náhradné koliesko / 22x6 mm	250	0,020

Rezač skla, plast



kód	popis		
219018	120x15 mm	12	0,025

PÍLKY NA PÓROBETÓN A VÝTLAČNÉ PIŠTOLE

Pílka s náradiem



kód	popis		
226376	+ meter a odlamovací nôž	12	0,200

Kosorez s pílkou



kód	popis		
226291	kosorez + píłka 300 mm	6	2,000
226385	250x80 mm	6	0,381

Píla na pórobetón, MetalProtection



kód	popis		
226427	700 mm, 17 zubov	6	1,092

Kosorez, plastový



kód	popis		
226495	kosorez 300 mm	6	0,100

Píla na pórobetón, Golden



kód	popis		
226388	700 mm, 17 zubov	6	1,092

Píla pokosová



kód	popis		
212719	550 mm	4	4,370
226111	list pílový, náhradný	1	

Píla na pórobetón



kód	popis		
226387	700 mm / 17 zubov	6	1,083

Pištoľ výtlačná na tmel, kovová



kód	popis		
217960	230 mm	40	0,350

Píla na pórobetón



kód	popis		
226498	28"/700mm / 81x40x16 cm	6	0,840

Nosič na sadrokartón



kód	popis		
2170100	max. 80kg / silný a ľahký Bezpečný a pohodlný nosič	25	0,415

Pištoľ výtlačná na tmel, plastová



kód	popis		
217188	240 mm	36	0,416

Píla na sadrokartón



kód	popis		
226426	s púzdom / 150 mm	1	0,300

Pištoľ výtlačná na tmel, nerezová

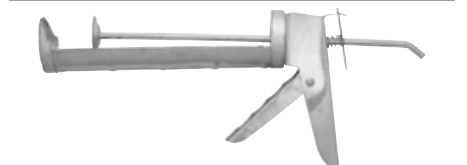

kód	popis		
217555	polouzavretá / 230 mm	50	0,380

Píla Shark, sadrokartón



kód	popis		
226393	150 mm	15	0,150

Pištoľ výtlačná na tmel, kovová

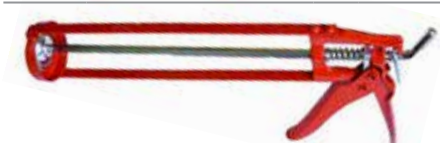

kód	popis		
217554	skelet / 235 mm	36	0,262

Pištoľ na montážnu penu



kód	popis	ks	kg
2170574	Alu, Cr, vysoke kvalitná pružina hliníkové telo a adaptér medená tryska hlaveň z nerezovej ocele	50	0,459

Pištoľ na montážnu penu



kód	popis	ks	kg
2170575	Alu, Cr, vysoke kvalitná pružina hliníkové telo hlaveň z nerezovej ocele tryska medená, poteflovaná teflonový povrch adaptéra	50	0,459

Pištoľ na montážnu penu, PTFE

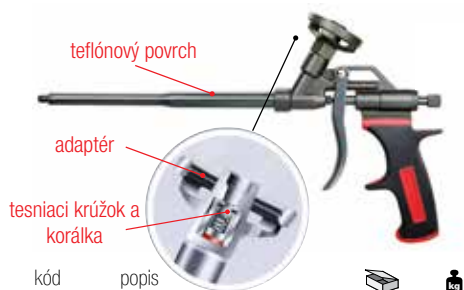

kód	popis	ks	kg
2170271	Alu, Cr, vysoke kvalitná pružina hliníkové telo a adaptér hlaveň z nerezovej ocele čierna povrchová úprava	50	0,459

Pištoľ na montážnu penu, kov-plast

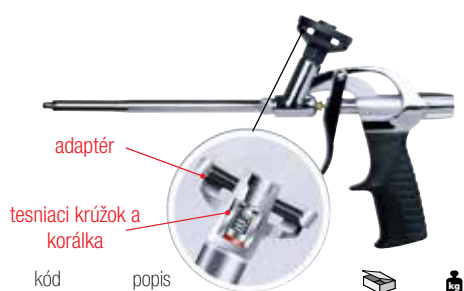

kód	popis	ks	kg
217349	Alu, Cr, vysoke kvalitná pružina hliníkové telo hlaveň z nerezovej ocele čierna povrchová úprava teflonový povrch adaptéra	20	0,564

Pištoľ na montážnu penu

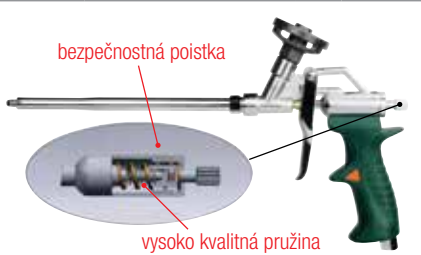

kód	popis	ks	kg
217592	180 mm hliníkové telo hlaveň z nerezovej ocele teflonový povrch adaptéra	20	0,525

Pištoľ na montážnu penu



kód	popis	ks	kg
217570	185 mm hliníkové telo a adaptér hlaveň z nerezovej ocele	20	0,550

Pištoľ na montážnu penu

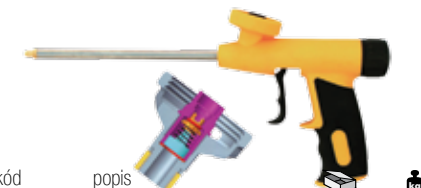

kód	popis	ks	kg
2170270	PP telo a adaptér hliníková tryska	1	0,376

Pištoľ na montážnu penu

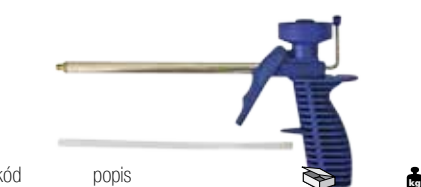

kód	popis	ks	kg
217190	180 mm / kov-plast	24	0,284

Pištoľ výtlačná na tmel, hliníková



kód	popis	ks	kg
217198	310 ml	20	0,550
217692	600 ml	36	0,750
217034	náhradná špička, bal. 3ks	500	0,040

Použitie: len na tmel v čírevku

Pištoľ výtlačná na tmel, kovová



kód	popis	ks	kg
217142	225 mm	24	0,490

Pištoľ výtlačná na tmel, kovová



kód	popis	ks	kg
2170433	310 ml	1	0,791
2170434	400 ml	1	0,800

Pištoľ výtlačná na tmel, kovová

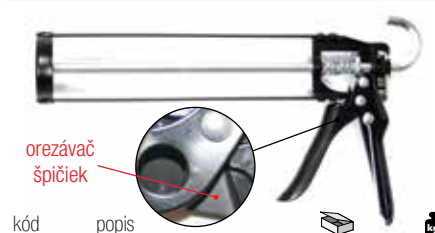

kód	popis	ks	kg
217587	230 mm, s orezávačom špičiek	1	0,800

Pištoľ výtlačná na tmel, kovová



kód	popis	ks	kg
217843	230 mm	24	0,580

Pištoľ výtlačná na tmel, kovová



kód	popis	ks	kg
217189	245 mm	20	0,550

Pištoľ výtlačná na tmel, kroková



kód	popis	ks	kg
217387	245 mm, kov-plast	24	0,710

Pištoľ výtlačná na chemickú kotvu



kód	popis	ks	kg
217518	2x 400ml, dvojkomponentová, kov	1	0,800

Sada voskových ceruziek



kód	popis		
212791	2ks / čierna a biela	2	0,050
212788	2ks / čierna a červená	2	0,050
212785	3ks / čierna, červená a biela	3	0,058

- Nevyžaduje strúhanie, jednoducho zatiahnite za šnúrku a očistíte viac z voskovej špičky

Ceruzka tesárska



kód	popis		
222552	červená tuha / 175 mm, bal 3ks	20	0,050
222282	čierna tuha / 175 mm	12	0,008
222526	čierna tuha / 250 mm	1	

Ceruzka tesárska



kód	popis		
222169	červeno-čierna	12	0,010

Ceruzka tesárska



kód	popis		
222895	180 mm / čierna	12	0,013
222357	250 mm / biela	12	0,013

Sada ceruziek, voskových



kód	popis		
222531	bal. 12ks	24	0,080

Sada ceruziek



kód	popis		
222959	hranatá, čierna / 175 mm	6	0,133

Sada ceruziek



kód	popis		
222960	ovál, červená/modrá / 175 mm	12	0,133

Sada ceruziek, šesťhranná



kód	popis		
222778	červená / modrá / 175mm	12	0,133

Strúhadlo na ceruzky



kód	popis		
222955	žlté	20	0,017

Šnúra murárska s navijačom



kód	popis		
2160425	30 m	10	0,111

Šnúra murárska s púdom



kód	popis		
2160557	šnúra 15 m	10	0,333
2160556	šnúra 30 m	12	0,350

Púder



kód	popis		
216727	150 g, modrý	100	0,160
216556	150 g, červený	100	0,160

Šnúra murárska s púdom



kód	popis		
216354	šnúra 30 m, mini vodováha	6	0,292

Motúz stavebný • 50m



kód	popis		
217338	biely, 1,0 mm	48	0,047
217015	biely, 1,7 mm	100	0,105
217394	biely, 2,0 mm	48	0,152
217244	žltý, 1,0 mm	48	0,047
217018	žltý, 1,7 mm	100	0,105
217214	žltý, 2,0 mm	100	0,152
217020	oranžový, 1,0 mm	100	0,047
217017	oranžový, 1,7 mm	48	0,105
217012	oranžový, 2,0 mm	48	0,154
217607	červený, 1,0 mm	100	0,047
217016	červený, 1,7 mm	48	0,105
217643	červený, 2,0 mm	100	0,152

Motúz stavebný



kód	popis		
216699	50 m	100	

Motúz na trni



kód	popis		
217685	030 m	1	0,073
217145	050 m	1	0,300
217041	100 m	24	0,135

Olovnica murárska



kód	popis		
216014	070 g	1	0,260
2160335	100 g	10	0,110
216163	300 g	6	

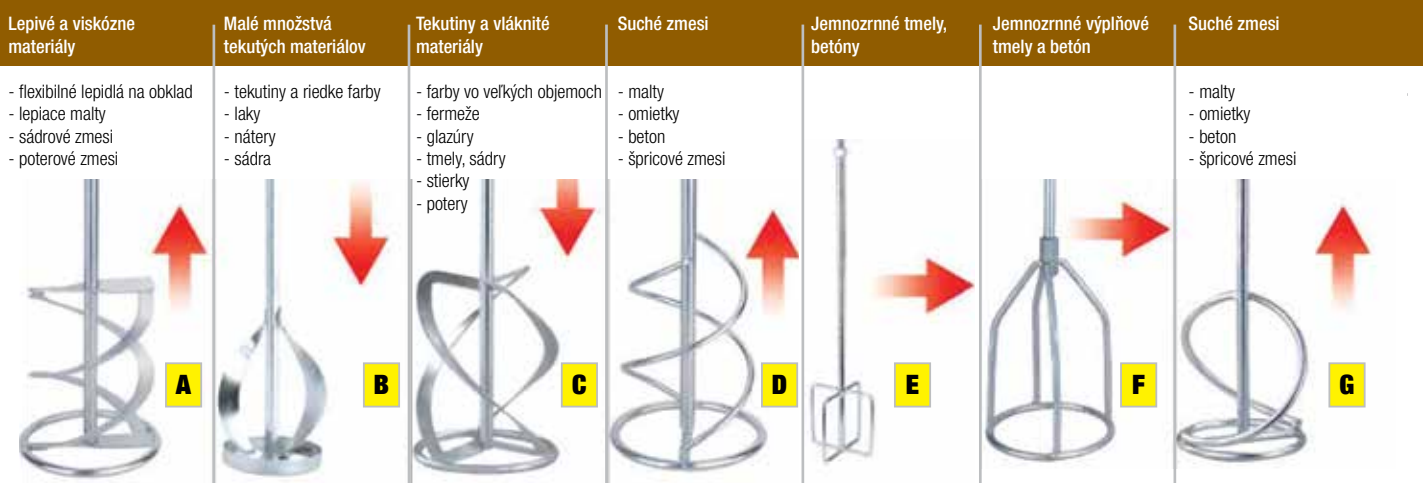

Miešadlo

kód	popis		
2160297	120x600x14 mm	20	1,300
2160298	140x600x14 mm	20	1,500

Miešadlo

kód	popis		
2160290	080x400 mm, SDS+	30	0,544
2160291	100x400 mm, SDS+	6	2,000

Miešadlo

kód	popis		
2160292	80x400 mm, SDS+	40	0,375

Miešadlo

kód	popis		
2160284	80x400 mm, SDS+	40	0,400

Miešadlo

kód	popis		
2160293	080x400 mm, SDS+	36	0,320
2160294	100x400 mm, SDS+	36	0,600

Miešadlo, Zn

kód	popis		
2160283	100x600 mm, SDS+	20	0,600

Miešadlo, Zn

kód	popis		
2160285	100x600 mm, SDS+	20	0,600

Miešadlo

kód	popis		
216221	060x400 mm	40	0,225
216203	080x400 mm	50	0,240
216220	100x600 mm	30	0,450
216229	120x600 mm	48	0,500

Miešadlo, Zn

kód	popis		
2160286	060x400 mm	36	0,300
2160287	080x400 mm	20	0,375
2160288	100x600 mm	36	0,650

Miešadlo, Zn

kód	popis		
2160145	060x400 mm	24	0,096
2160146	080x400 mm	50	0,300
2160188	100x500 mm	20	0,500
2160191	100x600 mm	20	0,550
2160192	120x600 mm	1	1,090

Miešadlo, Zn

kód	popis		
216313	090x500 mm	12	0,350
216097	110x600 mm	1	0,350

Miešadlo, Zn

kód	popis		
216319	060x400 mm	48	0,220
216403	080x400 mm	48	0,240
216613	100x400 mm	48	0,350
216655	100x600 mm	48	0,420
216656	120x600 mm	48	0,350

Miešadlo, Zn

kód	popis		
2160280	060x400 mm	36	0,300
2160281	080x400 mm	40	0,300
2160282	100x600 mm	20	0,600

Miešadlo Burley zo závitom M14

kód	popis		
2160902	100 mm	10	1,125
2160535	120 mm	10	1,125
2160536	140 mm	10	1,200
2160537	160 mm	10	1,810

Sada miešadiel

kód	popis		
216427	3 dielna	48	0,525

Miešadlo, YZn

kód	popis		
2160143	080x400 mm, SDS+	1	0,220
2160144	100x600 mm	1	0,650

Miešadlo, STRONG, Zn

kód	popis		
216249	100x600 mm	1	0,350

Miešadlo

kód	popis		
2160295	120x600x14 mm	36	1,300
2160296	140x600x14 mm	36	1,400

ZÁVESY, PETLICE A DRÔTY

Záves

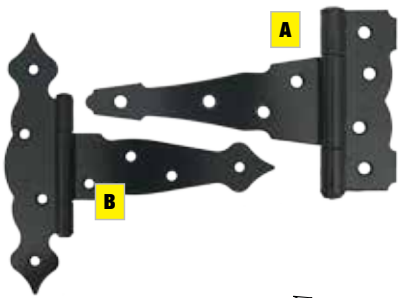

kód	popis		
221527	A) 127 mm / nylónové ložisko	20	0,191
221995	A) 152 mm / nylónové ložisko	20	0,242
221666	B) 127 mm / lakovaný	10	0,216
221667	B) 152 mm / lakovaný	10	0,283
2210863	B) 152 mm / Zn	10	0,283

Záves vratový



kód	popis		
252105	250 mm, 1 ks	120	0,500

Záves vratový



kód	popis		
221498	150 mm	10	0,140
221642	200 mm	10	0,230
221785	250 mm	10	0,300
221521	300 mm	10	0,350
221786	350 mm	10	0,260
221787	400 mm	10	0,333

Záves vratový



kód	popis		
221481	150 mm	10	0,520
221496	200 mm	10	0,610

Záves



kód	popis		
221434	90x3 mm	10	0,350

Záves navrací



kód	popis		
221502	11x060 mm	600	0,037
221212	16x070 mm	160	0,101
221214	18x090 mm	160	0,161
221195	20x100 mm	120	0,216

Záves ocelový



kód	popis		
221780	080 mm	12	0,140
221781	100 mm	12	0,190
221782	120 mm	12	0,360
221784	140 mm	12	0,410

Záves dverový, YZn



kód	popis		
221523	080x45x1.5 mm	6	0,100
221510	120x68x1.5 mm	6	0,213
221522	120x68x2.0 mm	6	0,337

Záves okenný



kód	popis		
221133	95x55x2.0 mm, Zn ľavý	12	0,200
221558	95x55x2.0 mm, Zn pravý	12	0,200
221560	95x55x2.0 mm, Fe ľavý	12	0,200
221663	95x55x2.0 mm, Fe pravý	12	0,200

Sada karabíniiek



kód	popis		
429087	5 ks	60	0,076

Sada háčik

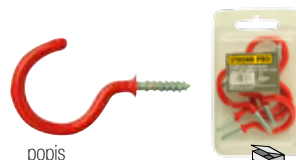

kód	popis		
2210591	1-3/4" / bal. 6ks	12	0,072

Drôt, Fe, priemyselné balenie



kód	popis / m v balení		
431148	0,80 mm, L-6400 m	25	1,000
431388	1,00 mm, L-4050 m	25	1,000
431081	1,25 mm, L-4050 m	25	1,000
431104	1,40 mm, L-2570 m	25	1,000
431082	1,60 mm, L-2050 m	50	1,000
431149	1,80 mm, L-1580 m	50	1,000
431083	2,00 mm, L-1250 m	50	1,000
431084	2,24 mm, L-2000 m	50	1,000
431085	2,50 mm, L-1600 m	50	1,000
431086	2,80 mm, L-1300 m	50	1,000
431087	3,15 mm, L-1050 m	50	1,000
431088	4,00 mm, L-800 m	50	1,000
431165	5,00 mm, L-320 m	50	1,000

* cena za 1 m / L = približná dĺžka v m / hmotnosť a balenie je orientačné

Drôt, Zn, priemyselné balenie



kód	popis / m v balení		
431071	0,80 mm, L-6400 m	25	1,000
431072	1,00 mm, L-4050 m	25	1,000
431073	1,25 mm, L-2570 m	25	1,000
431074	1,40 mm, L-2050 m	25	1,000
431075	1,60 mm, L-1580 m	25	1,000
431164	1,80 mm, L-1250 m	50	1,000
431076	2,00 mm, L-2000 m	50	1,000
431077	2,24 mm, L-1600 m	50	1,000
431078	2,50 mm, L-1300 m	50	1,000
431105	2,80 mm, L-1050 m	50	1,000
431079	3,15 mm, L-800 m	50	1,000
431116	4,00 mm, L-500 m	50	1,000
431175	5,00 mm, L-320 m	50	1,000

* cena za 1 m / L = približná dĺžka v m / hmotnosť a balenie je orientačné

Karabínka DIN5299C



kód	popis		
429080	040 mm	300	0,010
429081	050 mm	100	0,020
429082	060 mm	100	0,030
429083	070 mm	50	0,050
429084	080 mm	50	0,200
429085	090 mm	50	0,100
429076	100 mm	20	0,120
429088	120 mm	25	0,600

Karabínka s okom



kód	popis		
429045	05,0x050 mm, Zn	12	0,020
429046	07,0x070 mm, Zn	12	0,025
429047	08,5x085 mm, Zn	12	0,030
429048	10,5x100 mm, Zn	12	0,054

Kovanie na dvere s retiazkou



kód	popis		
252107		1	0,200

Zástrč dverová, lakovaná



kód	popis		
221562	075 mm	12	0,091
221755	100 mm	12	0,108
221678	125 mm	12	0,133
221561	150 mm	12	0,145
221754	200 mm	12	0,178

Petlica Hercules



kód	popis		
252167	150 mm	12	0,133
252168	200 mm	12	0,258

Petlica



kód	popis		
221196	100 mm	12	0,112
221197	127 mm	12	0,125

Zástrč dverová, YZn



kód	popis		
2210346	070x2 mm	12	0,230
2210347	085x2 mm	12	0,260
2210348	100x2 mm	12	0,300

Petlica Light, farebná



kód	popis		
252165	100 mm	12	0,040
252166	130 mm	12	

Magnetka na dvere



kód	popis		
2210300	62 mm	50	0,050

Páčidlo



kód	popis		
239255	0450x16 mm	24	0,850
239260	0500x16 mm	20	0,880
239265	0600x16 mm	20	1,208
239266	0700x16 mm	20	1,250
239261	0750x18 mm	20	1,750
239262	0800x18 mm	12	2,000
239263	0900x18 mm	12	1,920
239264	1000x20 mm	12	2,200

Váha vrecková



kód	popis		
217373	max. 012 kg	12	0,080
217374	max. 025 kg	6	0,194
217375	max. 050 kg	6	0,310
217376	max. 100 kg	6	0,583
217377	max. 150 kg	6	0,610

Držiak na sklo Zn



kód	popis		
217787	A) 1 kupolový, nosnosť 40 kg	30	0,600
217681	B) 3 kupolový, nosnosť 150 kg	10	1,500

Držiak na sklo Zn



kód	popis		
217867	2 kupolový, nosnosť 80 kg	20	0,900

Miska magnetická



kód	popis		
221334	100 kg	12	0,160

Držiak na sklo



kód	popis		
217919	A) nosnosť 50 kg	48	0,400
217922	B) nosnosť 100 kg	24	0,670

Držiak na sklo



kód	popis		
217702	nosnosť 140 kg	10	0,960

Držiak na sklo



kód	popis		
217599	4 kupolový, nosnosť 110 kg	1	1,400

Paska viazacia, nylon



kód	popis		
2171002	150x2,5 mm / zelená / 50ks	100	
2171003	200x2,5 mm / zelená / 50ks	100	
217048	120x2,5 mm / čierna / 50ks	600	
217057	200x3,6 mm / čierna / 50ks	500	
217058	250x3,6 mm / čierna / 50ks	500	
2170885	250x4,8 mm / čierna / 50ks	500	
2170886	300x4,8 mm / čierna / 50ks	500	
2170887	400x4,8 mm / čierna / 50ks	500	
2170888	500x4,8 mm / čierna / 50ks	500	
2170189	120x2,5 mm / biela / 50ks	600	
2170190	200x3,6 mm / biela / 50ks	500	
2170191	250x3,6 mm / biela / 50ks	500	
2170889	250x4,8 mm / biela / 50ks	500	
2170890	300x4,8 mm / biela / 50ks	500	
2170891	400x4,8 mm / biela / 50ks	500	
2170892	500x4,8 mm / biela / 50ks	500	

Klince stavebné 2825



kód	L	d		
418103	16	1,25	5 kg	
418089	20	1,40	5 kg	
418056	25	1,40	5 kg	
418059	32	1,60	5 kg	
418031	40	2,00	5 kg	
418026	50	2,20	5 kg	
418037	63	2,50	5 kg	
418013	70	2,80	5 kg	
418020	80	3,10	5 kg	
418021	90	3,50	5 kg	
418015	100	4,00	5 kg	
418032	110	4,00	5 kg	
418023	120	4,00	5 kg	
418016	130	4,00	5 kg	
418007	150	4,50	5 kg	
418036	150	5,00	5 kg	
418129	160	5,50	5 kg	
418038	160	6,30	5 kg	
418039	180	6,00	5 kg	
418033	200	6,30	5 kg	
418019	220	6,30	5 kg	
418005	250	7,60	5 kg	
418003	260	8,00	5 kg	
418002	300	8,00	5 kg	

Klince stavebné, MiniPack 1kg



kód	popis		
418146	016x1,25 mm	1kg	
418147	020x1,40 mm	1kg	
418148	032x1,60 mm	1kg	
418104	050x2,20 mm	1kg	
418140	063x2,50 mm	1kg	
418139	070x2,80 mm	1kg	
418138	080x3,10 mm	1kg	
418137	090x3,50 mm	1kg	
418136	100x4,00 mm	1kg	
418135	120x4,00 mm	1kg	



kód	popis		
418083	012x1,40mm	1	1,000
418084	016x1,60mm	1	1,000
418085	020x1,60mm	1	1,000
418086	025x1,80mm	1	1,000
418087	025x2,00mm	1	1,000

Klince krútené



kód	popis		
418047	60x3,5mm	1	1,000
418097	70x3,5mm	1	1,000
418091	80x3,5mm	1	1,000
418092	90x3,2mm	1	1,000

Klince lepenkáče, Zn



kód	popis		
418143	16x2,5 mm	2,5kg	
418134	20x2,5 mm	2,5kg	
418045	25x2,5 mm	2,5kg	
418052	32x2,5 mm	2,5kg	
418142	36x2,5 mm	2,5kg	

Klince svorky



kód	popis		
418114	25x2,5mm; U-tvar	1	1,000
418115	28x2,8mm; U-tvar	1	1,000
418116	30x3,1mm; U-tvar	1	1,000
418771	38x3,8mm; U-tvar	1	1,000

Klince kolárske



kód	popis		
418068	020x1,20mm	3	1,000
418070	020x1,25mm	1	1,000
418110	025x1,20mm	1	1,000
418054	032x1,40mm	1	1,000
418069	032x1,60mm	1	1,000
418046	040x1,80mm	1	1,000
418088	050x2,24mm	1	1,000
418048	063x2,50mm	1	1,000
418050	070x2,80mm	1	1,000

Skoba murárska



kód	popis		
212363	140 MM	130	0,157

Klince rákosnicke



kód	popis		
418113	32x2,5mm; trsteniaky	1	1,000

Svorka lanová



kód	popis		
212901	03 mm	1	0,005
212900	05 mm	1	0,010
212899	06 mm	1	0,010
212895	08 mm	1	0,020
212909	10 mm	1	0,030
212893	12 mm	1	0,050
212896	16 mm	1	0,080

Hmoždinka



kód	popis		
419002	Ø 08 mm, balenie 20ks	20	
419003	Ø 10 mm, balenie 20ks	20	
419004	Ø 12 mm, balenie 10ks	10	

Hmoždinka fasádna



kód	popis		
419050	10x080 mm	100	0,014
419044	10x120 mm	50	1,083
419052	10x140 mm	50	0,018
419051	10x160 mm	50	0,020
419053	10x180 mm	50	0,020

Hmoždinka



kód	popis		
419054	05x030 mm	200	0,003
419055	05x040 mm	200	0,006
419056	05x050 mm	200	0,004
419057	06x040 mm	200	0,004
419058	06x050 mm	200	0,003
419059	06x060 mm	200	0,010
419060	06x080 mm	200	0,010
419061	08x060 mm	100	0,100
419062	08x080 mm	100	0,120
419063	08x100 mm	100	0,150
419064	08x120 mm	100	0,180
419065	08x140 mm	100	0,020
419066	08x160 mm	80	0,020
419067	10x100 mm	50	0,030
419068	10x120 mm	50	0,030
419069	10x140 mm	50	0,030
419070	10x160 mm	50	0,040

Skrutka napínacia DIN-1480



kód	popis		
212342	05 mm	500	0,030
212649	06 mm	300	0,060
212203	08 mm	200	0,130
212360	10 mm	100	0,160
212372	12 mm	50	0,380
212493	16 mm	30	0,460
212032	20 mm	1	0,530

Vyťahovák klinec



kód	popis		
212686	300 mm	12	0,330

Vrutky do dreva, univerzálne

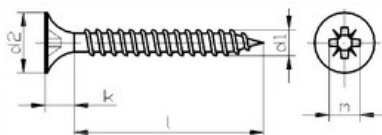

kód	popis		
4151989	2,5x015 mm	1000	0,390
415162	3,0x012 mm	1000	0,500
415109	3,0x016 mm	700	0,590
415113	3,0x020 mm	1000	0,720
415990	3,0x025 mm	1000	1,100
415712	3,0x030 mm	1000	1,080
4151152	3,0x035 mm		0,100
415191	3,0x040 mm	1000	1,430
4151389	3,0x045 mm	500	1,560
415545	3,0x050 mm	500	1,690
4150218	3,5x016 mm	1000	0,790
415114	3,5x020 mm	1000	1,500
4151274	3,5x025 mm		1,700
4150018	3,5x030 mm	1000	1,320
4150772	3,5x035 mm	500	1,590
415710	3,5x040 mm	1000	1,760
415717	3,5x045 mm	500	1,980
4150828	3,5x050 mm	500	2,200
415161	4,0x016 mm	1000	1,050
415706	4,0x020 mm	1000	1,280
4150561	4,0x025 mm	500	1,500
415193	4,0x030 mm	1000	2,060
4150530	4,0x035 mm	500	2,130
4150531	4,0x040 mm	500	2,830
415707	4,0x045 mm	500	2,550
4150529	4,0x050 mm	500	4,000
4151801	4,0x055 mm	250	3,150
415709	4,0x060 mm	500	3,460
4151150	4,0x080 mm	250	4,480
4151120	4,5x040 mm	500	3,200
4151095	4,5x045 mm	500	4,000
4150869	4,5x050 mm	500	5,170
4151823	4,5x060 mm	500	7,200
4150122	4,5x070 mm		6,400
415725	4,5x080 mm		7,600
4150761	5,0x020 mm	500	2,020
4150994	5,0x025 mm	500	2,490
415716	5,0x030 mm	500	2,960
4150995	5,0x035 mm	500	3,280
415703	5,0x040 mm	500	3,800
415163	5,0x045 mm	500	4,133
415304	5,0x050 mm	500	6,670
415164	5,0x060 mm	250	5,420
415167	5,0x070 mm	500	5,300
4150829	5,0x080 mm	250	7,400
4151390	5,0x090 mm	250	7,200
4151151	5,0x100 mm	250	20,000
4152259	5,0x110 mm		14,000
4150506	5,0x120 mm	125	18,000
4150917	6,0x040 mm	500	5,050
415733	6,0x050 mm	250	6,200
415724	6,0x060 mm	250	7,300
415735	6,0x070 mm	250	0,500
4151123	6,0x080 mm	250	5,000
4150870	6,0x090 mm	250	10,000
4151391	6,0x100 mm	250	19,000
4150830	6,0x120 mm	250	19,500
415944	6,0x130 mm		20,000
415985	6,0x140 mm		24,000
4151275	6,0x180 mm		30,000

Skrutka WS sadrokartón

kód	popis		
4152555	M3,5x25	1000	0,001
4152556	M3,5x35	1000	0,002
4152557	M3,5x45	1000	0,002

Skrutka FS sadrokartón

kód	popis		
4152542	M3,5x25	1000	0,001
4152543	M3,5x35	1000	0,002
4152544	M3,5x45	500	0,002
4152545	M3,5x55	500	0,003
4152546	M4,2x70	250	0,004
4152547	M4,2x80	250	0,005
4152548	M4,8x90	250	0,008

Skrutka SFT sadrokartón

kód	popis		
4152549	M3,5x25	1000	0,001
4152550	M3,5x35	1000	0,002
4152551	M3,5x45	500	0,002
4152552	M3,5x55	500	0,003
4152553	M4,2x70	250	0,005
4152554	M4,8x90	250	0,008

Skrutka na napínanie tyč

kód	popis		
431251	Y3/13 M08 / Zn	1	

Kotva zemná

kód	popis		
2170545	60x1,7x550 mm	1	
2170819	68x1,5x650 mm	1	
2170820	68x1,5x800 mm	1	

Kotva zemná

kód	popis		
2171009	550X60X1.7 mm	1	

Kľuč na zatváranie zem. skrutiek

kód	popis		
217004	60x50 mm	1	
217019	68x60 mm	1	

Reťaz plastová



kód	popis / m v balení		
432011	6 mm / 25m / žltá-čierna	1	0,063
432014	6 mm / 25m / červená-biela	1	0,063

Reťaz uzlíková pozinkovaná

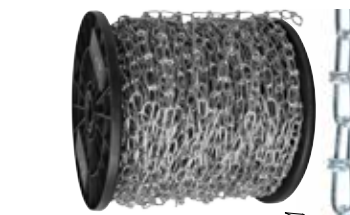

kód	popis / m v balení		
432022	1,8x25 mm	100	0,072
432087	2,2x31 mm	70	0,114
432026	2,8x39 mm	30	0,183

Reťaz pozinkovaná

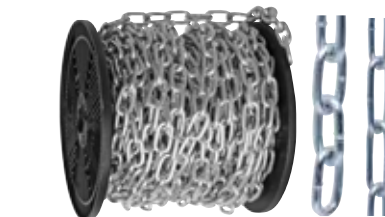

kód	popis / m v balení		
432017	2,2x15 mm / krátkočlánková	70	0,096
432012	3,0x16 mm / krátkočlánková	60	0,166
432015	4,0x19 mm / krátkočlánková	40	0,312
432019	5,0x21 mm / krátkočlánková	30	0,516
432020	6,0x24 mm / krátkočlánková	18	0,757
432013	8,0x32 mm / krátkočlánková	10	1,305
432002	3,0x26 mm / dlhočlánková	50	0,151
432004	3,5x28 mm / dlhočlánková	50	0,201
432076	4,0x32 mm / dlhočlánková	50	0,271
432016	4,5x34 mm / dlhočlánková	25	0,352
432009	5,0x35 mm / dlhočlánková	25	0,432
432033	6,0x42 mm / dlhočlánková	20	0,632
432005	10x65 mm / dlhočlánková	10	1,755

Pätka, ihlan



kód	popis		
217105	750x71 mm	1	
217106	750x91 mm	1	

UHOĽNÍKY A PODPERY / JOINTS

Uholník Zn



kód	popis		
429303	30x30x15/1,5 mm	1	0,012
429304	40x40x15/1,5 mm	1	0,014
429305	50x50x15/1,5 mm	1	0,018
429306	50x50x20/1,5 mm	1	0,030

Uholník zosilnený Zn



kód	popis		
429307	110x110x080/2,5 mm	1	0,265
429308	122x122x090/2,5 mm	1	0,300
429309	150x150x090/2,5 mm	1	0,507
429310	130x130x100/2,5 mm	1	0,460

Strmeň Zn



kód	popis		
429299	50x135 mm	1	0,333
429300	60x130 mm	1	0,373
429301	70x125 mm	1	0,383
429302	80x120 mm	1	0,373

Podpera nastaviteľná Zn



kód	popis		
429290	0-150 mm	1	1,222
429291	0-200 mm	1	1,306

Spojka Zn



kód	popis		
429311	180x60/2 mm	1	0,160
429312	200x40/2 mm	1	0,120

Podpera na zamurovanie Zn

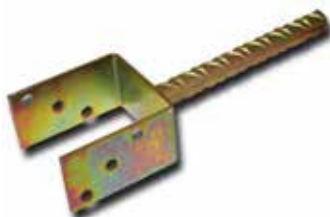

kód	popis		
429292	080 mm	1	0,853
429293	090 mm	1	0,373
429294	100 mm	1	0,886
429295	120 mm	1	0,897
429296	140 mm	1	1,360

Podpera nastaviteľná Zn



kód	popis		
429297	070-110 mm	1	1,085
429298	110-160 mm	1	1,028

Podložka pod závitovú tyč



kód	popis		
417114	M05 Ø05,5	1	
417333	M06 Ø06,6	1	
417115	M08 Ø09,0	1	
417066	M10 Ø11,0	1	
417067	M12 Ø14,0	1	
417291	M16 Ø18,0	1	
417292	M20 Ø22,0	1	
417412	M27 Ø30,0	1	

* cena za 1000 ks

Podpera na police, oceľová



kód	popis		
212379	100x125x33 mm, bal. 24ks	1	
2210982	100x150x34 mm, bal. 24ks	1	
2210983	125x150x34 mm, bal. 24ks	1	
2210984	150x200x36 mm, bal. 24ks	1	
2210985	200x250x38 mm, bal. 24ks	1	
2210986	250x300x42 mm, bal. 24ks	1	

Rohovník oceľový



kód	popis		
212849	100x22x2,5 mm	240	0,070

Tyč závitová, DIN-975 / 5.8



kód	popis		
4151037	M06 / Zn	100	0,148
4151038	M08 / Zn	50	0,273
4151039	M10 / Zn	25	0,442
4151040	M12 / Zn	20	0,653
4151129	M14 / Zn	10	0,885
4151041	M16 / Zn	10	1,205
4151029	M06 / Fe	100	0,154
4151030	M08 / Fe	50	0,273
4151031	M10 / Fe	25	0,442
4151032	M12 / Fe	20	0,653
4151033	M14 / Fe	10	0,820
4151034	M16 / Fe	10	1,183

Rohovník oceľový



kód	popis		
2210030	1.5", 4ks + vrutky	100	0,100
2210026	2.0", 4ks + vrutky	1	0,100

Uholník oceľový



kód	popis		
212877	100x22x2,5 mm	30	0,250
212878	125x22x2,5 mm	1	0,110
212879	150x30x2,8 mm	100	0,120
212892	200x33x2,8 mm	1	0,300

Svorka tesárska, kramľa



kód	popis		
212263	320x12 mm	60	0,350

Poklop kanálový

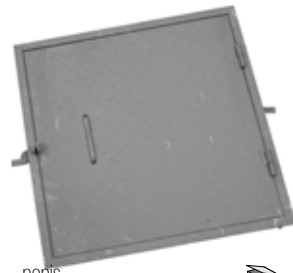

kód	popis		
217743	500x500 mm	1	8,500
217744	600x600 mm	1	12,000

Mriežka vetracia, PVC so sieťkou

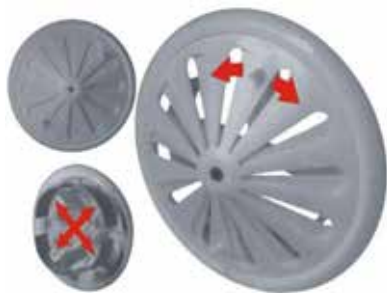

kód	popis		
2210534	100-150/170 mm, nastaviteľná	50	0,110

Mriežka vetracia, PVC so sieťkou

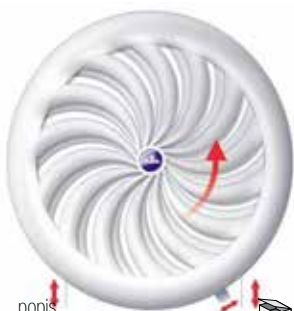

kód	popis		
2210532	150/180 mm, biela	50	0,110
2210530	100/135 mm, biela	70	0,110
2210531	110/135 mm, biela	70	0,110
2210533	100-150/180 mm, nastaviteľná	60	0,150

Mriežka vetracia, PVC so sieťkou



kód	popis		
2210541	250/200 mm, biela	25	0,160

Mriežka vetracia, PVC so sieťkou



kód	popis		
2210527	152/100 mm, biela	50	0,120
2210528	177/125 mm, biela	40	0,130
2210529	200/150 mm, biela	25	0,160

Mriežka vetracia, PVC so sieťkou



kód	popis		
221931	045/075 mm, biela	1	0,015
221923	070/100 mm, biela	1	0,052
221905	100/133 mm, biela	70	0,125
221926	125/158 mm, biela	50	0,125
221611	200/241 mm, biela	50	0,125

Mriežka vetracia biela, PVC



kód	popis		
2210538	200x165x150 mm, so sieťkou	45	0,140
2210540	280x140/245x102 mm, sieťka	45	0,160

Dvierka



kód	popis		
2210633	150x150x20 mm	1	0,120
2210634	150x200x20 mm	1	0,141
2210635	200x200x20 mm	1	0,186
2210636	200x250x24 mm	1	0,228
2210637	200x300x24 mm	1	0,251
2210638	300x300x28 mm	1	0,397
2210639	300x400x28 mm	1	0,511

Mriežka, kovová so sieťkou



kód	popis		
2210547	168/140 mm, biela	50	0,140
2210549	232x158/210x140 mm, biela	40	0,150

Mriežka, kovová so sieťkou



kód	popis		
2210548	168/140 mm, hnedá	50	0,140
2210550	232x158/210x140 mm, hnedá	40	0,150

Sada magnetických úchyto

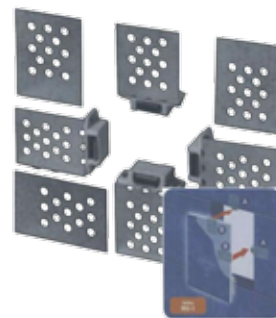

kód	popis		
2160689	pod obklad / 4ks / hrúbka 1mm	1	0,200



Zámok Tesla • K6072 P/L, Zn



kód	popis		
252126	72/60 - kľúč, ľavý	1	
252135	72/60 - kľúč, pravý	1	

Zámok Tesla • K6090/40, Zn



kód	popis		
252128	90/60 - kľúč, ľavý	1	
252129	90/60 - kľúč, pravý	1	

Zámok Tesla • V6072, Zn



kód	popis		
252136	72/60 - vložka, ľavý	1	
252134	72/60 - vložka, pravý	1	

Zámok Tesla • V6090 P/L, Zn



kód	popis		
252137	90/63/45 - vložka, ľavý	1	
252127	90/63/45 - vložka, pravý	1	

Zámok Tesla • V6090/40, Zn



kód	popis		
252148	90/63 - vložka, ľavý	1	
252115	90/63 - vložka, pravý	1	

Zámok HOBES • 536 P/L, Zn



kód	popis		
252100	80/90/50 - kľúč, pravo-ľavý	1	

Zámok HOBES • 24026 P/L, Zn



kód	popis		
252094	80/90/50 - vložka, pravo-ľavý	1	

Zámok HOBES • 02-06 P/L, Zn



kód	popis		
252088	90/60 - vložka, pravo-ľavý	1	

Zámok HOBES • K105, K106 Zn



kód	popis		
252200	K105, pravo-ľavý 60/72/40 - vložka	1	
252211	K106, pravo-ľavý 60/72/40 - vložka	1	

Zámok HOBES • K103, Zn



kód	popis		
252097	60/72/40 - kľúč, pravo-ľavý	1	

Zámok HOBES • 02-04 P/L, Zn



kód	popis		
252005	60/90/40 - vložka, pravo-ľavý	1	

Zámok HOBES • 01-15P/L, Zn



kód	popis		
252096	60/90/40 - vložka, pravo-ľavý	1	

Zámok HOBES • 548A P/L, Zn



kód	popis		
252099	90/80 - kľúč, pravo-ľavý	1	

Zámok HOBES • 02-03 P/L, Zn



kód	popis		
252089	90/60 - kľúč, pravo-ľavý	1	

Štitky KOMAS

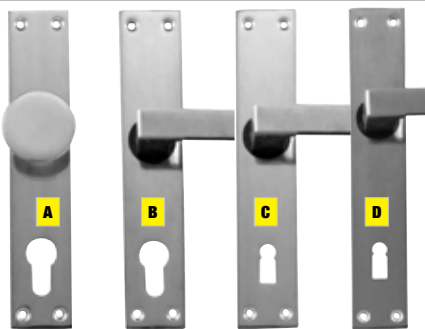

kód	popis		
252002	A) na kľúč	1	
252001	A) vložkový	1	
221751	B) dverný, vložkový	1	
221039	C) dverný, na kľúč	1	
221590	D) dverový Alu, na kľúč	1	
221591	D) dverový Alu, vložkový	1	

Kľučka Manuela



kód	popis		
2210074	A) biela / V72	1	
2210098	A) hnedá / V72	1	
2210137	A) strieborná / V72	1	
2210112	A) tepaná / V72	1	
2210084	A) zlatá / V72	1	
2210103	B) biela / V90	1	
2210101	B) hnedá / V90	1	
2210083	B) strieborná / V90	1	
2210114	B) tepaná / V90	1	
2210129	B) zlatá / V90	1	

Kľučka Manuela



kód	popis		
2210076	A) biela / K72	1	
2210121	A) hnedá / K72	1	
2210077	A) strieborná / K72	1	
2210115	A) tepaná / K72	1	
2210052	A) zlatá / K72	1	
2210100	B) biela / K90	1	
2210099	B) hnedá / K90	1	
2210271	B) strieborná / K90	1	
2210113	B) tepaná / K90	1	
2210128	B) zlatá / K90	1	

Vložka cylindrická, FAB



kód	popis		
252021	50D/30+35, 3 kľúče	1	0,200
252024	100RSD/29+35, 3 kľúče	1	0,200
252029	200RSD/29+35 mm, cylindrická, 5 kľúčov	1	0,200

Vložka cylindrická



kód	popis		
252157	30/30, 60 mm	12	0,208
252164	63 mm	12	0,212
252179	30/35 65 mm	12	0,216
252109	35/35 70 mm	12	0,235
252247	35/45 80 mm	12	0,265
252244	35/55 90 mm	12	0,295
252245	40/40 80 mm	12	0,265
252246	40/55 95 mm	12	0,310

Vložka cylindrická, SIS0



kód	popis		
2210001	30/35 mm	1	
2210007	30/40 mm	1	
2210008	30/50 mm	1	
2210005	35/35 mm	1	
2210006	35/45 mm	1	
2210012	35/55 mm	1	
2210009	40/40 mm	1	
2210010	40/55 mm	1	
2210011	50/40 mm	1	
2210004	50/55 mm	1	

Súprava TRIO, FAB



kód	popis		
252112	29+35, 6 kľúčov	1	0,200

Závora pre dvojkrídlové dvere



kód	popis		
252083	oceľ 4 mm	1	

Závora pre dvojkrídlové dvere



kód	popis		
217268	oceľ 4 mm	1	

Kľúčka



kód	popis		
2210310	Alu, s trňom	1	
221640	bez trňa	1	

Protipožiarný hydraulický zatvárač dverí

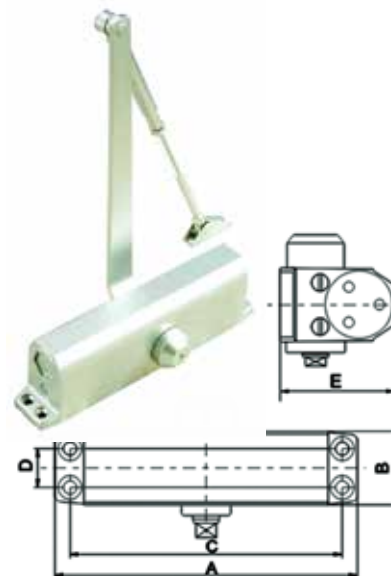

kód	popis		
2210989	25-45 kg A182xB42xE63xC165xD19 mm	10	2,000
2210990	45-75 kg A206xB45xE72xC188xD19 mm	10	2,000
2210991	65-90 kg A206xB206xE72xC188xD19 mm	10	2,000

Hydraulický zatvárač séria 5000.

Univerzálny hydraulický zatvárač dverí s nastaviteľnou uzatváracou silou EN 2/3/4.

Označený značkou CE v súlade s UNE EN 1154: 2003 / EN 1154: 1996.

S touto certifikáciou, EI 60 možné použitie na požiarné dvere protidymové dvere.

Nastaviteľná rýchlosť zatvárania (180 ° až 15 °), a konečná dorazová sila (15 ° -0 °).

Vysoká tepelná stabilita v rozmedzí -45 ° C až + 45 ° C.

Štandardné rameno alebo s nastaviteľným zámkom.

K dispozícii v striebornej farbe.

Trojročná záruka.

FUNKCIE:

- nastavenie rýchlosti
- pre zaseknutie
- pre zatváranie
- pre nastavenie dorazu

Bezpečnostný dotykový trezor



kód	popis		
221292	- rozmery vonkajšie: 230x350x290 - rozmery vnútorne: 225x345x248 - hmotnosť: 14 kg - poličky: 1	1	15,000

Používanie odtláčkov prsta namiesto kľúča alebo kódu pre veľké pohodlie. Je možné zaregistrovať maximálne 32 odtláčkov. Pevná konštrukcia odoláva útoku akéhokoľvek náradia. Originálny dizajn, jedinečná konštrukcia. Skryté núdzové kľúčové dierky.

Bezpečnostný elektronický trezor



kód	popis		
221202	- rozmery vonkajšie: 250x350x250 - rozmery vnútorne: 245x345x190 - hmotnosť: 10,5 kg - poličky: 1	1	9,500
221293	- rozmery vonkajšie: 500x350x310 - rozmery vnútorne: 495x345x250 - hmotnosť: 18 kg - poličky: 1	1	19,000

Otvorenie trezoru pomocou číselného kódu. Elektronický zámkový systém je navrhnutý pre vysokú bezpečnosť a ľahkú prevádzkovú činnosť. Je vybavený mechanickým zámkom pre bezpečné a rýchle otvorenie. 3 až 8 digitálnych kódov alebo núdzový kľúč.

Zámok visiaci



kód	popis		
252057	112/45	1	
252058	112/50	1	

- zvýšená odolnosť proti poveternostným vplyvom a rôznym metódam.

Zámok visiaci



kód	popis		
252056	395/30	1	

- zvýšená odolnosť proti poveternostným vplyvom a rôznym metódam.
- vysoká trieda

Zámok visiaci



kód	popis		
252466	820/30	1	
252062	830/40	1	

- vhodné pre vnútorné i vonkajšie použitie na brány, skrinky a šatne.

Zámok visiaci



kód	popis		
252009	A) FAB 38 mm	1	
252012	A) FAB 45 mm	1	
252014	A) FAB 52 mm	1	
252017	A) FAB 63 mm	1	
221274	B) 38 mm	6	0,167
221225	B) 45 mm	6	0,217
221098	B) 52 mm	6	0,317
221682	B) 63 mm	6	0,467

Zámok visiaci



kód	popis		
252176	A) 40 mm / HiSec	6	0,310
252177	A) 50 mm / HiSec	6	0,440
252178	A) 60 mm / HiSec	6	0,580
252073	B) 50 mm	1	0,420
252069	B) 60 mm	1	0,580

Zámok na bicykel



kód	popis		
252208	10x65 cm	30	0,200

Zámok na bicykel



kód	popis		
221890	650 mm	30	0,233

Zámok na bicykel



kód	popis		
252207	10x65 cm / 4 kódy	30	0,275

Zámok na bicykel



kód	popis		
252205	08x100 cm	30	0,233

Zámok na bicykel



kód	popis		
252209	08x120 cm	30	0,291

Zámok na bicykel



kód	popis		
252145	800 mm	18	0,580

Zámok visiaci Blossom



kód	popis		
252236	25 mm	1	
252237	32 mm	1	
252238	38 mm	1	
252239	50 mm	1	
252240	63 mm	1	

Zámok visiaci Blossom



kód	popis		
252231	25 mm	1	
252232	32 mm	1	
252233	38 mm	1	
252234	50 mm	1	
252235	60 mm	1	

Zámok visiaci Blossom



kód	popis		
252183	38 mm	1	0,138
252184	50 mm	1	0,284

Zámok visiaci Blossom



kód	popis		
252181	20 mm	1	0,034
252182	30 mm	1	0,061

Zámok visiaci Blossom



kód	popis		
252180	20 mm	1	0,023

Zámok visiaci vodeodolný Blossom



kód	popis		
252241	45 mm	1	
252242	55 mm	1	

Zámok mosadzný Blossom



kód	popis		
221159	A) 40 mm / 3x kľúčik	6	
252173	B) 50 mm / bezpečnostný	6	0,260

Zámok visiaci Blossom, Ms



kód	popis		
252175	45 mm	12	0,171
252174	55 mm	12	0,280

Zámok visiaci vodeodolný, plast



kód	popis		
252161	32 mm	1	
252110	38 mm	1	

Zámok visiaci Blossom



kód	popis		
252248	30 mm		
252249	40 mm		
252250	60 mm		

Zámok visiaci Blossom



kód	popis		
252004	38 mm		

Zámok visiaci Blossom Vico



kód	popis		
252171	H100 • 30 mm, oranžový	1	0,080
252172	A100 • 30 mm, zelený	1	0,080

Zámok visiaci Blossom



kód	popis		
252090	A) 20 mm / Vinyl	6	0,070
252091	A) 30 mm / Vinyl	1	0,130
252098	A) 40 mm / Vinyl	1	0,190
252076	B) 25 mm / Antirust	12	0,063
252080	B) 30 mm / Antirust	12	0,097
252082	B) 40 mm / Antirust	12	0,154
252085	B) 50 mm / Antirust	12	0,250
252066	B) 60 mm / Antirust	12	0,360

Zámok visiaci IronWedd



kód	popis		
252149	25 mm	12	0,060
252150	32 mm	6	0,080
252151	38 mm	6	0,110
252152	50 mm	6	0,170
252153	63 mm	6	0,320
252154	75 mm	6	0,460

Zámok visiaci Blossom, Ms



kód	popis		
221141	25 mm	12	0,042
221355	30 mm	12	0,054
221915	40 mm	12	0,088
221914	50 mm	6	0,150
221941	60 mm	6	0,230

SADY MALIARSKÉ, MRIEŽKY A VALČEKY

Vedro s valčekom a hladítkami



kód	popis		
2160779	12 litrov 1x hladítko EVA 8 mm 1x hladítko špongia 30 mm	6	1,000

Vedro s valčkami a hladítkom



kód	popis		
2160780	24 litrov 1x hladítko hydrošpongia	6	2,000

Vedro maliarske s valčkami



kód	popis		
254299	20 litrov	6	1,160

Vedro maliarske



kód	popis		
254359	15 litrov	1	0,553

Vedro maliarske



kód	popis		
254358	6 litrov	1	0,240

Mriežka kovová

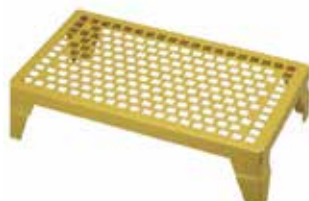

kód	popis		
2160781	na odkvapkanie	10	1,000

Mriežka GRID

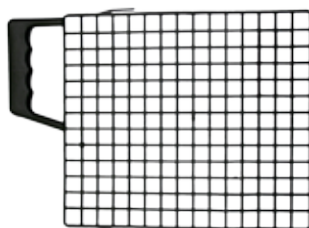

kód	popis		
2160340	300x200mm	200	0,055

Mriežka na valček

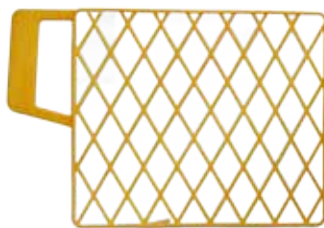

kód	popis		
2160242	210x250 mm	200	0,011
2160243	170x200 mm	200	0,039

Vanička na valček



kód	popis		
2160240	230x270 mm	1	
2160241	140x270 mm	1	

Sada maliarska



kód	popis		
2160467	štetce, valček, vanička	1	0,417

Sada maliarska



kód	popis		
216846	8 dielna / 10 cm	60	0,250

Sada maliarska



kód	popis		
253003	4 dielna	12	0,170

Sada maliarska



kód	popis		
2160393	valček 75 mm + vanička	10	0,090

Sada maliarska



kód	popis		
2160441	valčeky + vanička	25	0,140

PAINTING SETS AND ROLLERS

Sada maliarska CASPER



kód	popis		
2160338		1	0,220

Sada maliarska PRAMOS Acryl



kód	popis		
2160264	2 valčeky, vanička	20	0,315

Sada maliarska NAVOS Velur



kód	popis		
2160265	2 valčeky, vanička	36	0,315

Sada maliarska SAMBER

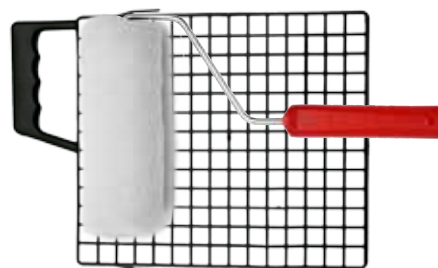

kód	popis		
2160339	180mm, držadlo+mriežka	1	

Držiak na valček

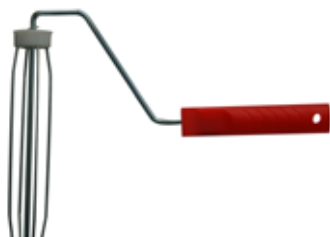

kód	popis		
2160584	38/230 mm	60	0,220

Držiak na valček

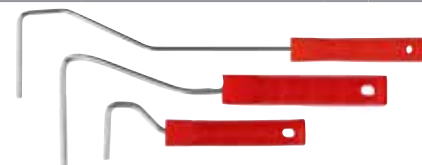

kód	popis		
2160272	040 mm, 06 mm (50-70 mm)	36	0,060
2160273	090 mm, 06 mm (100-160 mm)	5	0,079
2160274	240 mm, 06 mm (100-160 mm)	36	0,120

Držiak na valček

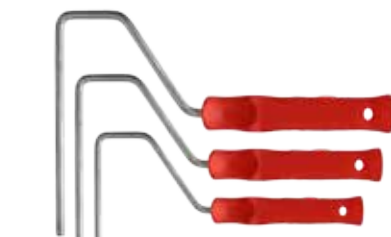

kód	popis		
2160226	180 mm, 08 mm	50	0,210
2160227	240 mm, 08 mm	50	0,232
2160228	150 mm, 06 mm	120	0,108
2160229	180 mm, 06 mm	50	0,120
2160230	240 mm, 06 mm	50	0,140

Valček rohový, akrylový



kód	popis		
2160262	80 mm valček, PES	36	0,170
2160261	80 mm valček, Akryl	36	0,174

Valček AMRY, plyšový



kód	popis		
2160341	180 mm, s držiakom	1	0,240

Valček maliarsky



kód	popis		
2160395	230 mm	10	0,200

Tyč



kód	popis		
2160399	1,0 m	1	0,140
2160400	1,5 m	10	0,160
2160401	2,0 m	25	0,480
2160565	2,0 m / teleskopická	25	0,680
2160543	3,0 m / teleskopická	1	0,830

Valček maliarsky



kód	popis		
2160397	A) 230 mm	10	0,280
2160398	B) 230 mm	50	0,320

Valček maliarsky



kód	popis		
2160396	A) 230 mm	50	0,280
2160464	B) 230 mm	1	0,290

Valček s držadlom



kód	popis		
2160466	230 mm	1	0,376

Valček s držadlom

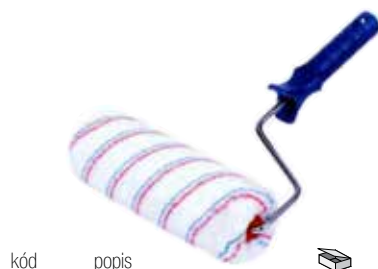

kód	popis		
2160465	230 mm	1	0,280

Valček Acrylic Mini Green



kód	popis		
2160378	150 mm, p15 mm, v10 mm	10	
2160379	100 mm, p15 mm, v10 mm	10	0,013

P - priemer, V - výška vlasu

Valček maliarsky PA Mini



kód	popis		
2160383	150 mm, p15 mm, v11 mm	10	
2160384	100 mm, p15 mm, v11 mm	10	0,013

P - priemer, V - výška vlasu

Valček fasádny JUMBO Green



kód	popis		
2160362	180 mm, P-58 mm, V18 mm	50	0,228
2160363	250 mm, P-58 mm, V18 mm	50	0,270

P - priemer, V - výška vlasu

Valček fasádny JUMBO

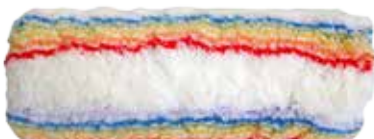

kód	popis		
2160364	180 mm, P-58 mm, V18 mm	50	0,228
2160365	250 mm, P-58 mm, V18 mm	50	0,274

P - priemer, V - výška vlasu

Valček maliarsky Nylon Mini



kód	popis		
2160385	150 mm, p30 mm, v6 mm	10	
2160386	100 mm, p30 mm, v6 mm	10	

P - priemer, V - výška vlasu

Valček lakovací Velour Mini



kód	popis		
2160387	070 mm, p15 mm, v4 mm	10	
2160388	110 mm, p15 mm, v4 mm	10	0,017
2160389	160 mm, p15 mm, v4 mm	10	

P - priemer, V - výška vlasu

Valček fasádny CLASSIC Green



kód	popis		
2160366	180 mm, P-48 mm, V18 mm	50	0,158
2160367	250 mm, P-48 mm, V18 mm	50	0,170

P - priemer, V - výška vlasu

Valček maliarsky Acrylic, stropný

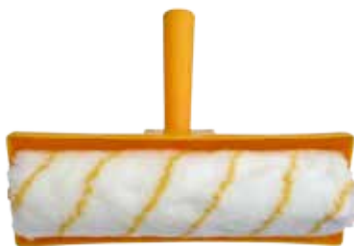

kód	popis		
2160231	240 mm, 48 mm	1	

P - priemer

Valček maliarsky PA



kód	popis		
2160370	180 mm, P-48 mm, V18 mm	50	0,136
2160371	240 mm, P-48 mm, V18 mm	50	0,274

P - priemer, V - výška vlasu

Valček fasádny, ovčia vlna



kód	popis		
2160376	180 mm, p48 mm, v20 mm	1	
2160377	240 mm, p48 mm, v20 mm	1	

P - priemer, V - výška vlasu

Valček fasádny CLASSIC



kód	popis		
2160368	180 mm, P-48 mm, V18 mm	50	0,158
2160369	250 mm, P-48 mm, V18 mm	50	0,170

P - priemer, V - výška vlasu

Valček maliarsky Nylon



kód	popis		
2160372	180 mm, P-48 mm, V12 mm	50	0,130
2160373	240 mm, P-48 mm, V12 mm	50	0,190

P - priemer, V - výška vlasu

Valček lakovací Velour



kód	popis		
2160374	180 mm, P-48 mm, v4 mm	50	0,126
2160375	240 mm, P-48 mm, v4 mm	50	0,148

P - priemer, V - výška vlasu

Valček maliarsky Acrylic Mini



kód	popis		
2160380	150 mm, p30 mm, v10 mm	10	
2160381	100 mm, p30 mm, v10 mm	10	0,031

P - priemer, V - výška vlasu

Valček nivelačný



kód	popis		
2160504	250 mm; nylon 20 mm; 8 mm	1	
2160503	400 mm; nylon 20 mm; 8 mm	1	
2160752	600 mm; nylon 20 mm; 8 mm	1	

Držiak magnetický, univerzálny



kód	popis		
212051	držiak na štetec, hladítko....	1	

Štetec plochý, drevený



kód	popis		
2160402	1"	12	0,020
2160403	1 1/2"	12	0,030
2160404	2"	12	0,060
2160405	2 1/2"	12	0,070
2160406	3"	12	0,080
2160407	4"	12	0,100

Štetec plochý, drevený



kód	popis		
2160408	1"	12	0,029
2160410	1,5"	12	0,033
2160409	2"	12	0,063
2160413	2 1/2"	12	0,070
2160415	3"	12	0,080
2160417	4"	12	0,100

Štetec plochý, Natural



kód	popis		
2160412	1"	10	0,029
2160414	1 1/2"	10	0,033
2160416	2"	12	0,062
2160418	2 1/2"	12	0,070
2160419	3"	10	0,080
2160420	4"	10	0,100

Štetec plochý, DeLux



kód	popis		
2160421	1"	10	0,029
2160422	1 1/2"	10	0,033
2160423	2"	10	0,063
2160424	2 1/2"	12	0,070
2160426	3"	10	0,080
2160427	4"	10	0,100

Sada štetcov



kód	popis		
2160220	5 dielna	100	0,250

Štetec zárohák, drevo



kód	popis		
2160276	1,0"	12	0,053
2160277	1,5"	12	0,065
2160275	2,0"	12	0,076
2160278	2,5"	12	0,087
2160279	3,0"	36	1,050

Štetec zárohák



kód	popis		
216270	1"	12	0,050
216273	1 1/2"	12	0,060
216297	2"	12	0,070
216298	2 1/2"	12	0,080
216311	3"	12	0,090

Štetec okrúhly, drevo



kód	popis		
216796	12	1	
216798	16	1	

Štetec okrúhly, plast



kód	popis		
216807	18	1	

Sada štetcov umeleckých



kód	popis		
216433	15 dielna	10	0,120

Sada štetcov



kód	popis		
2160435	2 dielna, 63.5 a 76.2 mm	100	0,140

Štetec okrúhly



kód	popis		
2160428	06	12	0,010
2160429	08	12	0,010
2160430	10	12	0,010
2160431	12	12	0,020
2160432	14	12	0,030
2160433	16	12	0,040
2160434	18	12	0,050

Štetec BRISK, plochý



kód	popis		
2160067	1,0"	12	0,042
2160068	1,5"	12	0,050
2160069	2,0"	12	0,055
2160070	2,5"	12	0,063
2160073	3,0"	12	0,067
2160074	4,0"	12	0,083
2160529	5,0"	12	0,100

Štetec plochý, plast



kód	popis		
2160075	1,0"	12	0,030
2160076	1,5"	12	0,044
2160077	2,0"	10	0,066
2160078	2,5"	10	0,079
2160079	3,0"	10	1,050
2160080	4,0"	10	0,150

Štetec plochý, drevo



kód	popis		
216299	1"	12	0,025
216300	1 1/2"	12	0,036
216301	2"	48	0,067
216291	2 1/2"	12	0,075
216292	3"	12	0,083
216295	4"	1	0,134

Sada štetcov



kód	popis		
216724	3 dielna	10	0,150

ŠTETKY, SADA ŠTETCOV/BRUSHES, SET OF PAINTING BRUSHES

Štetec Premium MASTER



kód	Výška	Hrubka	Šírka štetiny	
2160903	57 mm	14 mm	1"	12
2160904	57 mm	15 mm	1.5"	12
2160905	64 mm	17 mm	2"	12
2160906	64 mm	20 mm	2.5"	12
2160907	70 mm	20 mm	3"	12
2160908	76 mm	22 mm	4"	12

Profesionálny plochý štetec, rukoväť z bukoveho dreva - lakovaná gravírovanie loga na rukoväti, nerezová oceľová objímka, najvyššia kvalita zmesi štetin TOP 90. Ideálna pre olejové farby, laky, lazúry

Štetec Premium LOBO



kód	Výška	Hrubka	Šírka štetiny	
2160909	44 mm	15 mm	20 mm	12
2160910	51 mm	15 mm	30 mm	12
2160911	51 mm	15 mm	40 mm	12
2160912	51 mm	15 mm	50 mm	12
2160913	51 mm	15 mm	60 mm	12
2160914	57 mm	15 mm	70 mm	12
2160915	57 mm	15 mm	80 mm	12
2160916	57 mm	15 mm	90 mm	12
2160917	57 mm	15 mm	100 mm	12

Plochý štetec, plastová rukoväť, potlač na rukoväti vysokej kvality, pocinovaná oceľ, mix štetin TOP 60. Pre olejové farby, laky, lazúry

Štetec plochý



kód	popis		
2160437	3x7	12	0,080
2160438	3x10	12	0,100
2160439	3x12	12	0,112
2160440	4x14	12	0,300

Štetka maliarska PROFI

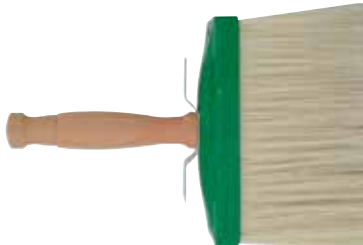

kód	popis		
2160469	170x70mm	16	0,625

Štetka murárska



kód	popis		
216608	70 mm, umelý vlas	12	0,260

Štetka murárska



kód	popis		
216610	17x170 mm	12	0,190

Páska ochranná



kód	popis		
217809	0550 mm, L-35 m	6	0,320
217810	1100 mm, L-35 m	6	0,490

Fólia ochranná s lepiacim pásikom



kód	popis		
217811	180 mm, L-20 m	6	0,220
217808	550 mm, L-30 m, PE	48	0,160

Univerzálna krycia fólia



kód	popis		
217885	4x05,0 m; 5,5 μ / Hobby	24	0,110
217841	4x12,5 m; 5,5 μ / Hobby	50	0,230

Univerzálna krycia fólia



kód	popis		
2170838	4x05,0 m; 12 μ / Standard	60	
2170839	4x12,5 m; 12 μ / Standard	30	

Univerzálna krycia fólia



kód	popis		
2170840	4x05,0 m; 40 μ / Extra	30	

Páska izolačná

Odolnosť do 80°C. Použitie do 600V.



kód	popis		
212670	19 mm, L-10 m, čierna	10	0,035
212562	19 mm, L-10 m, žltá	10	0,035
212561	19 mm, L-10 m, červená	10	0,035
212750	19 mm, L-10 m, hnedá	10	0,035
212749	19 mm, L-10 m, modrá	10	0,035
212607	19 mm, L-10 m, zelenožltá	10	0,035
212836	19 mm, L-10 m, zelená	10	0,035
212837	19 mm, L-10 m, biela	10	0,035

Páska izolačná, rôzne farby

Odolnosť do 80°C. Použitie do 600V.



kód	popis		
217716	19 mm, L-10 m	10	0,415

Páska izolačná



kód	popis		
313082	A) pláténá, 19 mm, L20 m	10	0,110
212660	B) PVC HOBBY, L10 m	10	0,040

Sklotextilná páska lepiaca



kód	popis		
217674	50 mm, L75 m	36	0,252

Páska rohová, oceľová



kód	popis		
2160336	50 mm, L-30 m	10	0,850

Páska teflónová



kód	popis		
212063	12x0,075 mm, L-10 m	10	0,007
219782	12x0,100 mm, L-50 m		

Páska maskovacia, krepová



kód	popis		
217798	25 mm, L-25 m	6	0,110
217801	30 mm, L-50 m	6	0,230

Páska maskovacia, modrá



kód	popis		
217783	50x50 mm, 70 mm	1	0,070

Páska maskovacia, exteriér, UV

Odolná voči UV
Pre vonkajšie
použitie.
Modrá.



kód	popis		
2170280	38 mm, L-50 m	6	0,240
2170281	50 mm, L-50 m	6	0,311

Páska maskovacia, interiér

Na vnútorné použitie.
Odoláva do:
60°C a 80°C



kód	popis		
217760	19 mm, L-50 m, 60°C	6	0,110
217762	25 mm, L-50 m, 60°C	6	0,140
217763	30 mm, L-50 m, 60°C	6	0,140
217764	38 mm, L-50 m, 60°C	6	0,210
217765	50 mm, L-50 m, 60°C	6	0,280
217773	25 mm, L-50 m, 80°C	6	0,160
217777	30 mm, L-50 m, 80°C	6	0,180
217778	38 mm, L-50 m, 80°C	6	0,230
217791	50 mm, L-50 m, 80°C	6	0,290

Páska na rúry



kód	popis		
217806	50 mm, L-25 m	6	0,260

Páska lepiaca, PVC



kód	popis		
217804	75 mm, L-33 m	6	0,420

Páska opravná, PVC



kód	popis		
2170283	48 mm, L-10 m	6	0,119
2170282	48 mm, L-50 m	6	0,457

Páska obojstranná, látková



kód	popis		
217805	25 mm, L-25 m	6	0,180

Páska Alu



kód	popis		
217796	A) 50 mm, L-25 m, zosilnená	6	0,250
217797	B) 50 mm, L-25 m	6	0,260

Páska baliaca



kód	popis		
217793	48 mm, L-50 m	6	0,130
217794	48 mm, L-50 m, bal. 6 ks	6	0,750

Páska



kód	popis		
222413	A) 48 mm, L50 m, priesvitná	50	0,260
217880	B) 75 mm, L250 m, červeno-biela	1	

Páska "ZÁKAZ VSTUPU"



kód	popis		
217566	75 mm, L-250 m		

Držiak lepiacej páske



kód	popis		
2160266	50 mm	36	0,500

ELEKTRICKÉ NÁRADIE



ELEKTRO

Aku skrutkovač

20V



Li Ion

kód	popis		
113900	Aku napätie: 20 V Rýchlosť bez záťaženia: 0 ~ 450 / 0 ~ 1650 rpm Kapacita batérie: 4,0 Ah Li-Ion Max. krútiaci moment: 50 Nm Stupeň krútiacieho momentu: 20+1+1 Nm Doba nabíjania: 1 hodina Počet priklepov: 0~7200 / 0~26400 Upínací priemer: 13 mm	1	

Použitie: vŕtanie do dreva, kovu, keramiky a plastických hmôt
- elektronická regulácia otáčok a doľava / doprava otáčanie
- vhodný aj pre skrutkovanie a rezanie závitov
-Akumulátor nie je súčasťou balenia

Aku rázový uťahovák

20V



Li Ion

kód	popis		
119123	Aku napätie: 20 V Rýchlosť bez záťaženia: 0 ~ 3000 rpm Počet rázov: 0-3500/min Kapacita batérie: 4,0 Ah Li-Ion Max. krútiaci moment: 160 Nm Doba nabíjania: 1 hodina Upínanie: 1/4" Nastaviteľná rýchlosť	1	

Akumulátorový rázový uťahovák je určený na povoľovanie / uťahovanie skrutiek, ako aj na uťahovanie a povoľovanie matic v príslušnom rozsahu rozmerov.

-Akumulátor nie je súčasťou balenia

Aku uhlová brúska

20V



Li Ion

kód	popis		
113904	Aku napätie: 20 V Kapacita batérie: 4,0 Ah Li-Ion Doba nabíjania: 1 hodina Rýchlosť bez záťaženia: 10 000 rpm Priemer kotúča: 115 mm Závit na vreteno: M14	1	

Použitie: na brúsenie, rezanie a odstraňovanie kovových a kamenných materiálov bez použitia vody. S vhodným príslušenstvom je ju možné použiť aj na čistenie.c

4.0Ah LITHIUM MULTI SYSTEM

Akumulátor

Kapacita batérie: 4,0 Ah Li-Ion
Doba nabíjania: 1 hodina
Menovité napätie: 20 V
1130315



kód	popis		
114028	Reproduktor - 15 W, Bluetooth, 15x16x18 cm, funkcia nabíjania	1	
114028	Adaptér pre USB nabíjanie	1	

Píla chvostová

20V



Li Ion

kód	popis		
114028	Aku napätie: 20 V Kapacita batérie: 4,0 Ah Li-Ion Doba nabíjania: 1 hodina Otáčky bez záťaženia: 0~3000 rpm Rezanie v dreve: 80 mm Rezanie v kove: 20 mm Rezanie v oceli: 10 mm Zdvih pílového plátku: 26 mm	1	

- reže každý materiál
- všetky štandardné pílové listy, na drevo, kov alebo z pružného bimetalu
- obľúčená rukoväť
- pre bezpečnú manipuláciu a ľahkú prácu
-Akumulátor nie je súčasťou balenia

Píla priamočiara

20V



Li Ion

kód	popis		
114336	Aku napätie: 20 V Kapacita batérie: 4,0 Ah Li-Ion Doba nabíjania: 1 hodina Otáčky bez záťaženia: 0-2500 rpm Rezanie v plaste: 12 mm Rezanie v oceli: 6 mm Rezanie v dreve: 80 mm Šikmé rezy: 0~45°	1	

Použitie: na krížny rez a odrezávanie dreva, plastov, keramických dosiek a gumy. Je vhodná pre priame a vlnité rezy pod uhlom od 0- 45°
-Akumulátor nie je súčasťou balenia

1 BATÉRIA PRE 12 STROJOV



Nabíjačka

Príkon: 60 W
Napätie / frekvencia: 230 V / 50 Hz
Približná doba nabíjania:
2,0 Ah - 50 min / 4,0 Ah - 100 min
Výstup: 21 V \approx 2,4 A
1130316

Multifunkčné náradie

20V



kód popis

119035 Aku napätie: 20 V
Kapacita batérie: 4,0 Ah Li-Ion
Doba nabíjania: 1 hodina
Rýchlosť okruhov bez zaťaženia: 8 000 - 18 000 rpm
Oscilačný uhol: 3,2 °
Príslušenstvo: (1) brusný vankúš, (2) 3x výsek, (3) 3/8" široká čepeľ
(4) škrabák, (5) 1/2" polkruhová čepeľ, (6) kľúč

1130169 Sada brusných papierov, P100, 10ks / **1130170** Sada brusných papierov, P120, 10ks
1130168 Sada brusných papierov, P080, 10ks /
1130138 Sada brusných papierov, 60/80/100/120/150, 5ks / **1130159** Sada dielov, 20-21-22-27
1130161 Skrutka upínacia, 1/4" / **1130158** Uhlík náhradný
1130139 Kotúč polokruh HSS, náhradný /
1130141 Kotúč polokruh, 65 Mn, náhradný / **1130140** Nôž oválny, 65 Mn, 50x20 mm, náhradný
1130136 Nôž rovný, 65 Mn, náhradný / **1130137** Nôž triangular, 65 Mn, náhradný

Použitie:

- na pílenie a rezanie drevených materiálov, plastov, sádrových dosiek, neželezných kovov a spojovacích prvkov (napr. netvrdných klincov, sponiek)
- na vyrezávanie do sadrokartonu a škrabanie malých povrchov
- na prácu v blízkosti kútov, kde je ťažký prístup a pre prírežovanie pri povrchu

-Akumulátor nie je súčasťou balenia

Aku okružná píla

20V



kód popis

114323 Aku napätie: 20 V
Kapacita batérie: 4,0 Ah Li-Ion
Doba nabíjania: 1 hodina
Aretácia vretena: áno
Otáčky naprázdno: 3800 rpm
Priemer kotúča: 165 mm
Hĺbka rezu pri 45°: 40 mm
Hĺbka rezu pri 90°: 54 mm

Použitie: na pozdĺžne a priečne rezanie dreva rovnými rezní, ako aj uhlovými rezní do 45 °. S príslušnými pilovými listami možnosť rezať aj neželezné kovy, ľahké stavebné materiály a plasty.
-Akumulátor nie je súčasťou balenia

Aku vyžinač, teleskopický

20V



Li Ion

kód popis

111354 Aku napätie: 20 V
Otáčky naprázdno: 9000 rpm
Šírka záberu: 30 cm
Kapacita batérie: 4,0 Ah Li-Ion
Doba nabíjania: 1 hodina
Plastová hlava
Otočná rukoväť
Súčasťou balenia: 12 nožov

1110375 Sada nožov 20ks 20

Akumulátorový vyžinač je určený na kosenie trávy a buriny do výšky 125mm, ktorá sa nedá pokosiť kosačkou na trávnik. Používanie podľa určenia sa vzťahuje na teplotu okolia medzi 0°C a 40 °C.

-Akumulátor nie je súčasťou balenia

Aku nožnice na živý plot

20V



Li Ion

kód popis

111360 Aku napätie: 20 V
Otáčky naprázdno: 1050 / min
Dĺžka lišty: 56 cm
Dĺžka zuba: 20 mm
Kapacita batérie: 4,0 Ah Li-Ion
Doba nabíjania: 1 hodina

Akumulátorové nožnice na živý plot sú určené iba na strihanie živých plotov, kríkov a krovín.

-Akumulátor nie je súčasťou balenia

Aku fúkar na listie

20V



Li Ion

kód popis

111328 Aku napätie: 20 V
Otáčky naprázdno: 13 000 / min
Rýchlosť vzduchu: 60 m/s
Prietok vzduchu: 3,5 m³/min
Kapacita batérie: 4,0 Ah Li-Ion
Doba nabíjania: 1 hodina

Zariadenie slúži na odstraňovanie suchého listia zo záhrad.

-Akumulátor nie je súčasťou balenia

Aku skrutkovač s LED osvetlením

10.8V



Li Ion

kód	popis	1	kg
113772	Aku napätie: 10,8 V Rýchlosť bez zaťaženia: 0 ~ 350 / 0 ~ 1350 rpm Kapacita batérie: 1,3 Ah Li-Ion Max. krútiaci moment: 26 Nm Stupeň krútiacieho momentu: 18+1 Nm Doba nabíjania: 1 hodina Min/max upínací priemer: 0.8 ~ 10 mm Batéria: 2x rýchlonabíjateľná	1	1,000
1130179	Náhradný akumulátor Li-Ion 1300 mAh	1	
1130193	Nabíjačka CD-10,8Li	1	

Použitie: vŕtanie do dreva, kovu, keramiky a plastických hmôt
- elektronická regulácia otáčok a dolava / doprava otáčanie
- vhodný aj pre skrútkovanie a rezanie závitov

Aku skrutkovač s LED osvetlením

12V



Li Ion

kód	popis	1	kg
113881	Aku napätie: 12 V Rýchlosť bez zaťaženia: 0 ~ 400 / 0 ~ 1300 rpm Kapacita batérie: 1,5 Ah Li-Ion Max. krútiaci moment: 27 Nm Stupeň krútiacieho momentu: 19+1 Nm Doba nabíjania: 1 hodina Min/max upínací priemer: 0.8 ~ 10 mm Batéria: 1x rýchlonabíjateľná	1	1,400
1130348	Náhradný akumulátor Li-Ion 1500 mAh	1	
1130349	Nabíjačka CD-12Li	1	

Použitie: vŕtanie do dreva, kovu, keramiky plastu a betónu
- elektronická regulácia otáčok a dolava / doprava otáčanie
- vhodný aj pre skrútkovanie a rezanie závitov

Aku skrutkovač s LED osvetlením

14.4V



Li Ion

kód	popis	1	kg
113844	Aku napätie: 14,4 V Rýchlosť bez zaťaženia: 0 ~ 400 / 0 ~ 1500 rpm Kapacita batérie: 1,5 Ah Li-Ion Max. krútiaci moment: 26 Nm Stupeň krútiacieho momentu: 21+1 Nm Doba nabíjania: 1 hodina Min/max upínací priemer: 0.8 ~ 10 mm kovové skľučovadlo Batéria: 2x rýchlonabíjateľná Funkcia: príklep	1	1,300
1130076	Náhradný akumulátor Li-Ion 1500 mAh	1	
1130194	Nabíjačka CD-14,4Li	1	

Použitie: na vŕtanie do dreva, kovu, keramiky a plastov.
- elektronická regulácia otáčok a dolava / doprava otáčanie
- vhodný aj pre skrútkovanie a rezanie závitov

Aku skrutkovač s LED osvetlením

20V



2.0Ah / Li Ion

kód	popis	1	kg
113884	Aku napätie: 20 V Rýchlosť bez zaťaženia: 0 ~ 400 / 0 ~ 1550 rpm Kapacita batérie: 2,0 Ah Li-Ion Max. krútiaci moment: 50 Nm Stupeň krútiacieho momentu: 25+1+1 Nm Doba nabíjania: 1 hodina Min/max upínací priemer: 0.8 ~ 13 mm Kovové skľučovadlo Batéria: 2x rýchlonabíjateľná	1	1,750
1130350	Náhradný akumulátor Li-Ion 2000 mAh	1	
1130351	Nabíjačka CD-20LiH	1	

Použitie: na vŕtanie do dreva, kovu, keramiky, plastu a muriva.
- elektronická regulácia otáčok a dolava / doprava otáčanie
- vhodný aj pre skrútkovanie a rezanie závitov
- špeciálna funkcia, ktorá umožňuje skrutkovač použiť ako vŕtacie kladivo do betónu

Aku skrutkovač

16V



Li Ion

kód	popis	1	kg
113901	Aku napätie: 16 V Rýchlosť bez zaťaženia: 0 ~ 400 / 0 ~ 1400 rpm Kapacita batérie: 1,5 Ah Li-Ion Max. krútiaci moment: 30 Nm Stupeň krútiacieho momentu: 19+1 Nm Doba nabíjania: 1 hodina Min/max upínací priemer: 0.8 ~ 10 mm Batéria: 2x rýchlonabíjateľná Kovové skľučovadlo	1	
1130414	Náhradný akumulátor Li-Ion 1500 mAh	1	
1130415	Nabíjačka CD-16Li	1	

Použitie: vŕtanie do dreva, kovu, keramiky a plastických hmôt
- elektronická regulácia otáčok a dolava / doprava otáčanie
- vhodný aj pre skrútkovanie a rezanie závitov

Aku skrutkovač s LED osvetlením, mini

3.6V



Li Ion

kód	popis	1	kg
113690	Aku napätie: 3,6 V Kapacita batérie: 1,3 Ah Li-Ion Otáčky naprázdno: 200 rpm Max. krútiaci moment: 3.0 Nm Obsahuje: 24 ks bitov Doba nabíjania: 3-5 hodín	1	0,300
1130156	Náhradný akumulátor Li-Ion 1300 mAh	1	

Skrutkovač elektrický

300W



kód	popis	1	kg
113193	Príkon: 300 W Napätie / frekvencia: 230 V / 50 Hz Otáčky naprázdno: 0~400 / 0~1450 rpm Max. krútiaci moment: 35 Nm Stupeň krútiacieho momentu: 21+1 Nm Upínací rozsah: 10 mm plastové skľučovadlo	1	1,710

Použitie: na vrtanie do tehál, betónu, kameňa, dreva, kovu, keramiky a plastov ako aj na skrutkovanie. **Výhodou je dvojrýchlostná prevodovka.**

Vrtacie kladivo

1800W



kód	popis	1	kg
113140	Príkon: 1800 W Napätie / frekvencia: 230 V / 50 Hz Počet príklepov: 4000 bpm Rýchlosť bez záťaženia: 800 rpm Max. priemer vrtania: drevo 40 mm, betón 38 mm, oceľ 13 mm Energia príklepu: 4,5 J	1	4,400

1130377 Uhlík náhradný 1

Použitie: na príklepové vrtanie do betónu, tehál, kameňa, dreva, plastu, kovu a rovnako aj na skrutkovanie (použitie špeciálne príslušenstvo).
- príklepový systém v tomto výrobku prevyšuje tradičnú ručnú vrtačku pri vrtaní do betónu
- určené na používanie v kombinácii so všetkými štandardami SDS + príslušenstvo

Vrtacie kladivo

820W

820W



kód	popis	1	kg
113387	Príkon: 820 W Napätie / frekvencia: 230 V / 50 Hz Počet príklepov: 4800 bpm Rýchlosť bez záťaženia: 0-1300 rpm Max. priemer vrtania: drevo 40 mm, betón 26 mm, oceľ 13 mm Energia príklepu: 3 J Funkcia: vrtanie, vrtanie s príklepom Vymeniteľná hlava	1	2,800

NOVINKA

1130152	Uhlík náhradný	1	
1130416	Vymeniteľná hlava	1	
113175	Príkon: 820 W Napätie / frekvencia: 230 V / 50 Hz Počet príklepov: 4800 bpm Rýchlosť bez záťaženia: 0-1300 rpm Max. priemer vrtania: drevo 40 mm, betón 26 mm, oceľ 13 mm Energia príklepu: 3 J Funkcia: vrtanie, vrtanie s príklepom	1	2,800

Použitie: príklepové vrtanie do betónu, tehál, kameňa, dreva, plastu, kovu a rovnako aj na skrutkovanie (špeciálne príslušenstvo by malo byť použité).
- príklepový systém v tomto výrobku prevyšuje tradičnú ručnú vrtačku pri vrtaní do betónu
- používanie v kombinácii so všetkými štandardami SDS + príslušenstvo

Príklepová vrtačka

800W



kód	popis	1	kg
113060	Príkon: 800 W Napätie: 230 V / 50 Hz Rýchlosť bez záťaženia: 0-2700 rpm Max. priemer vrtania: drevo 20 mm, betón 13 mm, oceľ 10 mm Max. upínací priemer: 13 mm	1	2,880

1130048 Uhlík náhradný 1

Použitie: vrtanie s príklepom do tehál, betónu a kameňa, ako aj na vrtanie do dreva, kovu, keramiky a plastu
- elektronická regulácia otáčok a doľava / doprava otáčanie
- vhodná na skrutkovanie a rezanie závitov

Vrtačky stojanové so zverákom

350W



450W



kód	popis	1	kg
113416	Príkon: 350 W Napätie / frekvencia: 230 V / 50 Hz Rýchlosť bez záťaženia: 580-2650 rpm Rozsah natočenia stola: 45° ~ 45° Posuv vretena: 50 mm Max. priemer vrtania: 13 mm Prevody: 5	1	16,000

113174	Príkon: 450 W Napätie / frekvencia: 230 V / 50 Hz Rýchlosť bez záťaženia: 250-2800 rpm Rozsah natočenia stola: 45° ~ 45° Posuv vretena: 80 mm Max. priemer vrtania: 16 mm Prevody: 12	1	40,000
--------	---	---	--------

Demolačné kladivo

1500W



kód	popis	1	kg
113410B	Príkon: 1700 W Napätie / frekvencia: 230 V / 50 Hz Počet úderov: 1400 rpm Sila úderu: 45 J	1	16,000
11330233	Sekáč plochý	1	
1130234	Sekáč špicatý	1	
1130235	Uhlík náhradný	1	

Použitie: na príklepové vrtanie do betónu, tehál, kameňa, dreva, plastu, kovu a rovnako aj na skrutkovanie (použitie špeciálne príslušenstvo).
- príklepový systém v tomto výrobku prevyšuje tradičnú ručnú vrtačku pri vrtaní do betónu
- určené na používanie v kombinácii so všetkými štandardami HEX + príslušenstvo

Uhlová brúska

750W



kód	popis		
113137	Príkion: 750 W Napätie / frekvencia 230 V / 50 Hz Rýchlosť bez záťaže: 12000 rpm Priemer kotúča: 125 mm Premenná rýchlosť: Nie Závit na vretene: M14	1	2,100
113399	Príkion: 750 W Napätie / frekvencia 230 V / 50 Hz Rýchlosť bez záťaže: 12000 rpm Priemer kotúča: 115 mm Premenná rýchlosť: Nie Závit na vretene: M14	1	
1130413	Uhlík náhradný	1	

1. Lahké čistenie krytu proti prachu 2. Vysoko-kvalitná povrchová úprava 3. Oprášovaná izolácia 4. KVM ventilátor

Použitie: na brúsenie, rezanie a odstraňovanie kovových a kamenných materiálov bez použitia vody. S vhodným príslušenstvom je ju možné použiť aj na čistenie.

Uhlová brúska

2350W



Funkcia: možnosť otočenia rukoväte do troch polôch.

kód	popis		
113698	Príkion: 2350 W Napätie / frekvencia 230 V / 50 Hz Rýchlosť bez záťaže: 6500 rpm Priemer kotúča: 230 mm Premenná rýchlosť: Nie Závit na vretene M14 Funkcia Soft Start: plynulý rozbeh	1	5,500
1130027	Uhlík náhradný	1	

Použitie: na brúsenie, rezanie a odstraňovanie kovových a kamenných materiálov bez použitia vody. S vhodným príslušenstvom je ju možné použiť aj na čistenie.

Stolová brúska

120W

200W



kód	popis		
113696	Príkion: 200 W Napätie / frekvencia 230 V / 50 Hz Rýchlosť bez záťaže: 2950 rpm Priemer kotúča: 150 x 16 x 12,7 mm	1	4,800

Uhlová brúska

1350W



kód	popis		
113694	Príkion: 1350 W Napätie / frekvencia 230 V / 50 Hz Rýchlosť bez záťaže: 3000-8500 rpm Priemer kotúča: 150 mm Premenná rýchlosť: Áno Závit na vretene M14	1	2,300
1130004	Uhlík náhradný	1	

Použitie: na brúsenie, rezanie a odstraňovanie kovových a kamenných materiálov bez použitia vody. S vhodným príslušenstvom je ju možné použiť aj na čistenie.

Leštička na auto

1400W



kód	popis		
113759	Príkion: 1400 W Napätie / frekvencia: 230 V / 50 Hz Rýchlosť bez záťaže: 1000-3000 rpm Priemer kotúča: 180 mm Funkcia: regulácia otáčok	1	3,500
1130147	Uhlík náhradný	1	
113211	Vankúš leštiaci WPP / ovčia vlna	1	0,300
113783	Špongia leštiaca / SPP	1	0,300

Stolová brúska

1200W



kód	popis		
113630	Príkion: 1200 W Napätie / frekvencia 230 V / 50 Hz Rýchlosť bez záťaže: 2950/134 rpm Rozmery brusného kotúča na suché brúsenie: 150 x 20 x 12,7 mm Rozmery brusného kotúča na mokré brúsenie: 200 x 40 x 20 mm	1	

Použitie: na obrábanie a brúsenie nožov, nožníc, dlát a nástrojov s ostrím. Brúska je vybavená kotúčom na mokré a suché brúsenie. Hrubé brúsenie zasadne vykonávajú s kotúčom na suché brúsenie. Jemné brúsenie naopak vždy vykonávajú s kotúčom na mokré brúsenie.

Multifunkčné náradie

300W



kód	popis		ks
119176	Prikon: 300 W Rýchlosť okruhov bez zaťaženia: 10 000 - 18 500 rpm Oscilačný uhol: 2,8 ° Napätie / frekvencia: 230 V / 50 Hz Príslušenstvo: (1) brusný vankúš, (2) 3x výsek, (3) 3/8" široká čepeľ (4) škrabák, (5) 1/2" polkruhová čepeľ, (6) kľúč	1	2,400

1130169 Sada brusných papierov, P100, 10ks / 1130170 Sada brusných papierov, P120, 10ks
1130168 Sada brusných papierov, P080, 10ks /
1130138 Sada brusných papierov, 60/80/100/120/150, 5ks / 1130159 Sada dielov, 20-21-22-27
1130161 Skrutka upínacia, 1/4" / 1130158 Uhlík náhradný
1130139 Kotúč polokruh HSS, náhradný /
1130141 Kotúč polokruh, 65 Mn, náhradný / 1130140 Nôž oválny, 65 Mn, 50x20 mm, náhradný
1130136 Nôž rovný, 65 Mn, náhradný / 1130137 Nôž triangular, 65 Mn, náhradný

Použitie:

- na pílenie a rezanie drevených materiálov, plastov, sádrových dosiek, neželezných kovov a spojovacích prvkov (napr. netvrdných klinec, sponiek)
- na vyrezávanie do sadrokartonu a škrabanie malých povrchov
- na prácu v blízkosti kútov, kde je ťažký prístup a pre prerezávanie pri povrchu

Priama brúska

NOVINKA



kód	popis		ks
114324	Prikon: 135 W Napätie / frekvencia 230 V / 50 Hz Otáčky bez záťaže: 10 000-32 000 rpm Skľučovadlo: 3,2 mm Dĺžka napájacieho kábla: 1,8 m Príslušenstvo: - 10 ks brusný kotúč s nastavcom 3,2 mm - 2 ks diamantové bity 3,2 mm - 1 ks brusný pás - 1 ks nastavec 3,2 mm - 1 ks upínací trň pre rezný kotúč - 1 ks upínací trň pre filcový leštiaci kotúč - 1 ks filcový leštiaci kotúč	1	
114288	Sada náradia	1	
1130398	Uhlík náhradný	1	

Použitie: na detailné obrábanie kovov, plastov, dreva a podobných materiálov s použitím vhodného obrábacieho nástavca.



Pila okružná

1300W



kód	popis		
113697	Príkonný: 1300 W Napätie / frekvencia: 230 V / 50 Hz Aretácia vretena: áno Otáčky naprázdno: 4500 rpm Kotúč: 185x16 mm Hĺbka rezu pri 45°: 44 mm Hĺbka rezu pri 90°: 65 mm	1	4,260

1130148 Uhlík náhradný
2260062 Kotúč pilový 185x16 mm z24

Použitie: na pozdĺžne a priečne rezanie dreva rovnými rezmi, ako aj uhlovými rezmi do 45°. S príslušnými pilovými listami možnosť rezat aj neželezné kovy, ľahké stavebné materiály a plasty.

Pila chvostová

750W



kód	popis		
114015	Príkonný: 750 W Napätie / frekvencia: 230 V / 50 Hz Otáčky: 800-2700 rpm Hrúbka rezu do dreva: 115 mm Hrúbka rezu do ocele: 15 mm Zdvih pilového plátku: 26 mm	1	

1130353 Nôž náhradný 1
1130354 Uhlík náhradný 1

Regulácia otáčok. Reže každý materiál - všetky štandardné pilové listy, na drevo, kov alebo z pružného bimetalu. Oblúčková rukoväť - pre bezpečnú manipuláciu a ľahkú prácu.

Pila priamočiara

570W

800W



kód	popis		
113185	Príkonný: 570 W Napätie / frekvencia: 230 V / 50 Hz Otáčky: 800-3000 rpm Rezanie v dreve: 65 mm Šikmé rezy: 0-45°	1	2,000

1130412 Uhlík náhradný 1
113676 Príkonný: 800 W
Napätie / frekvencia: 230 V / 50 Hz
Otáčky: 800-3000 rpm
Rezanie v dreve: 100 mm
Šikmé rezy: 0-45°

1130054 Uhlík náhradný 1

Použitie: na krížny rez a odrezávanie dreva, plastov, keramických dosiek a gumy. Je vhodná pre priame a vlnité rezy pod uhlom od 0-45°

Multifunkčná pokosová pila s laserom

2000W



kód	popis		
113887	Príkonný: 2000 W Otáčky: 5000 rpm Rozmery kotúča: 255x30 mm (60 zubov) Napätie / frekvencia: 230 V / 50 Hz Max. hĺbka rezu pre 90° x 90°: 75 x 300 mm Max. hĺbka rezu pre 90° x 45°: 75 x 210 mm Max. hĺbka rezu pre 45° x 90°: 40 x 210 mm Max. hĺbka rezu pre 45° x 45°: 40 x 305 mm	1	16,000

1130337 Uhlík náhradný 1
Pokosová pila slúži na orezávanie dreva a drevu podobných materiálov, primerane k veľkosti zariadenia. Pila umožňuje pozdĺžne a priečne rezy s rovným priebehom rezu. Taktiež sú možné horizontálne uhly zošikmenia od -45° do +45° ako aj vertikálne uhly zošikmenia od 0° do 45°. Pila nie je vhodná na pílenie palivového dreva, hliníka ani žiadnych iných neželezných kovov. Protikĺzne pogumovanie na rukoväti a nosnej rukoväti. Bočné nosné rukoväte. Prepravná poistka a navíjanie kábla. Otočný stôl s presným nastavením uhlov. Pracovný stôl zo zliatiny hliníka. Laser pre presné ukazovanie rezu. Plynule vyťahovateľné rozšírenie stola na oboch stranách s praktickou výložnou plochou a integrovaným pozdĺžnym dorazom. Integrovaná regulácia hĺbky rezu. Všetky stupnice viditeľné z pracovnej pozície. Odsávací vak pre čistý vzduch na pracovisku. Súčasťou pily je univerzálny pilový kotúč pre veľmi hladký rez

Horná fréza

250W



kód	popis		
114345	Príkonný: 250 W Napätie / frekvencia 230 V / 50 Hz Otáčky bez záťaže: 11 000 - 30 000 rpm Upínací priemer: 6/8 mm Max. zdvih frézovacieho koša: 55 mm	1	

Použitie: na frézovanie drážok, hrán, profilov a drážok do dreva, materiálov z plastu a ľahkého povrchu. Tento prístroj nie je určený pre vonkajšie použitie.

Pásová brúska

810W



kód	popis		
113132	Príkion: 810 W Napätie / frekvencia: 230 V / 50 Hz Rýchlosť pásu bez záťaže: 200-380 rpm Rozmer pásu: 76x533 mm	1	3,500

- 1130144 Uhlík náhradný
- 1130163 Sada brúsnych papierov, P100, 10ks
- 1130164 Sada brúsnych papierov, P120, 10ks
- 1130162 Sada brúsnych papierov, P080, 10ks

Použitie: na suché brúsenie s vysokým výkonom odstraňovania materiálov z dreva, plastu, kovu, atď.

Hoblík elektrický

900W



kód	popis		
114292	Príkion: 900 W Napätie / frekvencia: 230 V / 50 Hz Rýchlosť bez záťaže: 16000 rpm Šírka záberu: 82 mm Hĺbka záberu: 3 mm	1	2,900

- 1130149 Uhlík náhradný
- 1140003 Nôž náhradný, diel 17
- 1140004 Nôž náhradný, diel 17-18-19

Použitie: na hladenie a hoblívanie materiálov ako sú brvná, hranoly a dosky. Tiež je vhodný pre skosenie hrán a žliabkovanie

Vibračná brúska

300W



kód	popis		
113178	Príkion: 300 W Napätie / frekvencia : 230 V / 50 Hz Rýchlosť bez záťaže: 6000-11000 mpm Rozmer papiera: 115x230 mm	1	2,130

- 1130150 Uhlík náhradný
- 1130166 Sada brúsnych papierov, P100, 10ks
- 1130167 Sada brúsnych papierov, P120, 10ks
- 1130165 Sada brúsnych papierov, P080, 10ks

Použitie: na suché brúsenie a ukončovanie drevených, maľovaných povrchov a plastov

Excentrická brúska

NOVINKA



kód	popis		
114325	Príkion: 430 W Napätie / frekvencia 230 V / 50 Hz Otáčky bez záťaže: 6 000-12 000 rpm Priemer podložky: 150 mm Priemer brúsneho papiera: 150 mm Dĺžka napájacieho kábla: 2 m Zaručená hladina akustického výkonu: 91 db(A)	1	

- 243183 Výsek 150 mm, P080
- 243442 Výsek 150 mm, P100
- 243183 Výsek 150 mm, P120
- 1130388 Uhlík náhradný

Použitie: na brúsenie dreva, kovov a náterov. Toto zariadenie nepoužívajte na mokré brúsenie.



Stolová píla, 2x predĺžovací stôl

2000W



kód	popis		
113885	Príkion: 2000 W Otáčky: 5000 rpm Rozmery kotúča: 255x30 mm (24 zubov) Napätie / frekvencia: 230 V / 50 Hz Max. hĺbka rezu pre 90°: 85 mm Max. hĺbka rezu pre 45°: 65 mm Rozmery stola: 642 x 478 x 28 mm	1	21,000

Dobrá stolová píla je základným vybavením každej dielne. Toto náradie je určené na pozdĺžne a priečne rezanie dreva rovným rezom alebo rezom pod uhlom max. 45°. Pilové kotúče tohto náradia sú vyrobené z neželezných kovov a umožňujú rezať ľahký stavebný materiál a plasty. Súčasťou píly je pilový kotúč s prerezom 85 mm, nechýba bočný doraz, uhlové pravítko, bezpečnostný kryt, nástavec na odsávanie pilín. Dobrým pomocníkom je možnosť bočného rozšírenia stola, vďaka ktorému si upravíte pracovnú plochu podľa potreby. Výškové nastavenie kotúča a nezávislé ovládanie sklonu rezného kotúča.

Píla na kov

2300W



kód	popis		
113120	Príkion: 2300 W Otáčky: 4000 rpm Rozmery kotúča: 355 x 3,2 x 25,4 mm Napätie / frekvencia: 230 V / 50 Hz Max. hĺbka rezu: 80 mm	1	16,500
1130149	Uhlík náhradný	1	

Rezač na dlaždice

800W



kód	popis		
212131	Príkion: 800 W Otáčky: 2950 rpm Rozmery kotúča: 230x25,4 mm Napätie / frekvencia: 230 V / 50 Hz Rozmery stola: 1170x400 mm Dĺžka rezu: 930 mm Hĺbka rezu pri 45°: 38 mm Hĺbka rezu pri 90°: 40 mm	1	35,000

Profesionálna rezačka okladačiek pre domácich majstrov, komplet s čerpadlom chladiacej vody a nádobou na vodu. Stroj môže byť použitý na bežné rezanie betónových dosiek, dlažbových kameňov, mramorových a žulových dosiek, tehál, kachličiek, dlaždíc atď. podľa veľkosti stroja. Stroj je koncipovaný na domáce a remeselné použitie. Rezanie dreva a kovov nie je dovolené. Súčasťou stroja je aj kotúč 230 mm.



Priemyselný vysávač na mokré i suché vysávanie

1600W

4m
cable



kód	popis		
119189	Príkion: 1600W Napätie / frekvencia: 230 V / 50 Hz Veľkosť nádrže: 30 lit. Maximálne zaťaženie: 2000 W Tlak: 16 Kpa Priemer hadice: 32 mm Hlučnosť: 80 db	1	8,000

Použitie: Na mokré i suché vysávanie. Vysávač je určený na vysávanie a výtah materiálov a nehorľavých tekutín, ktoré neohrozujú ľudský život. Príslušenstvo: 1.Filter / 2.Vrečko na odpad / 3.Filter na mokré vysávanie / 4.Trubica / 5.Kefa / 6.Hadica

119165	Vrečko PROFI, textilné
1130262	Vrečko náhradné, papierové
1130261	Filter
1130264	Filter penový
1130256	Hadica
1130257	Hlavica na podlahu
1130258	Hlavica úzka
1130259	Hlavica na koberec
1130260	Trubica

Vysávač na popol

STREND PRO®



kód	popis		
119154	príkion: 800W napätie / frekvencia: 220-240V / 50Hz/60Hz veľkosť nádrže: 18lit. el. šnúra: 4,5m Príslušenstvo: 1.Kovová hadica / 2.Filter / 3.Hliníková tryska	1	5,700
119160	filter náhradný	1	



Viacúčelový vysávač



kód	popis		
119236	Príkion: 1200 W Napätie / frekvencia: 230 V / 50 Hz Sací príkon: 193 W Objem nádrže: 15 lit. Max. prietok vzduchu: 45 l/s Podtlak: >=17 kPa Dĺžka hadice: 1,5 m Priemer hadice: 32 mm Stupeň ochrany: IPX4 Dĺžka kábla: 4,5 m	1	

Použitie: Na mokré i suché vysávanie.

- Zvuková kontrolka naplnenia nádoby.
- Funkcia fúkania.
- Jednoduché uvoľnenie a uzamykanie odpadovej nádoby.
- Špeciálny zadný odnímateľný kryt vzduchového filtra. Lahká výmena vzduchového filtra. Zabránenie znečisteniu.
- Množstvo doplnkov pre takmer všetky vaše potreby
- Príslušenstvo uložené na jednom mieste
- Robustný a jednoduchý pohyb
- Pohodlná rukoväť
- 4,5 m kábel a 1,5 m hadica umožňujú dostatočný dosah a minimalizujú potrebu použitia predlžovacieho kábla
- Ultra tichý a ekologicky šetrný

Zváračací invertor ST Welding XP-180

STREND PRO

- 1 - jednofázové
- 2 - elektrické ovládanie
- 3 - ochrana voči prehriatiu
- 4 - antilepivá vlastnosť
- 5 - chladené ventilátorom
- 6 - káblový konektor
- 7 - prislúšenstvo súčasťou balenia
- 8 - prenosnosť



kód	popis	1	kg
116037 A)	Napätie / frekvencia: 230 V / 50 Hz Vstupný výkon: 7.2 kVA Výkon: 180 A / 27.2 V Výstupný prúd: 30-180 A Napätie naprázdno: 67 V Pracovný cyklus: 40 % Účinnosť: 85 % Krytie: IP21S Trieda izolácie: F Priemer elektródy: 1.6-4.0 mm Rozmer: 405 x 260 x 275 mm	1	7,500
116075 B)	Napätie / frekvencia: 230 V / 50 Hz Vstupný výkon: 7.2 kVA Výkon: 170 A / 26.8 V Výstupný prúd: 20-180 A Napätie naprázdno: 63 V Pracovný cyklus: 40 % Účinnosť: 85 % Krytie: IP21S Trieda izolácie: F Priemer elektródy: 1.6-4.0 mm Rozmer: 365 x 245 x 260 mm	1	6,400
116043	Náhradný uzemňovací kábel so svorkou / 3 m / max. 200 A	1	
116044	Náhradný zváračací kábel s držiakom na elektródu / 4 m / max. 200 A	1	

Polyfúzna zváračka plastových rúr

STREND PRO



kód	popis	1	kg
213149	Napätie 230 V Príkon 800 W Regulátor teploty 50-380°C Použiteľné pre trubky PP-R, PB, PE, PE-X Najvyššia pracovná teplota 380 °C	1	2,500
213698	Nadstavec náhradný 16 mm	1	
213700	Nadstavec náhradný 20 mm	1	
213701	Nadstavec náhradný 25 mm	1	
213702	Nadstavec náhradný 32 mm	1	

Zariadenie sa používa na spájanie plastových rúr ako sú PP-R a PE. Tento typ zváračky sa využíva na spájanie rúr s nasledujúcimi priermi: 16- 20 - 25 - 32 mm.
Obsahje: Imbus kľúč, stojan, kovový kufor.

Zváračka ST Welding MIG/MAG, Typ: MIG195

NOVINKA



Zváračací kábel 1,8 m
Uzemňovací kábel 1,6 m
MIG horák
Štít a kefa



kód	popis	1	kg
116029	Napätie / frekvencia: 230 V / 50 Hz Vstupný výkon: 7.6 kVA Prúdový rozsah MMA: 40 A / 16 V - 180 A / 23 V Prúdový rozsah MIG: 40 A / 21,6 V - 190 A / 27,6 V Zaťažovateľ MMA: 60% 190 A / 27,6 V 100% 147 A / 25,9 V Zaťažovateľ MIG: 60% 180 A / 23 V 100% 139 A / 21 V Napätie naprázdno: 55 V Pracovný cyklus: 30 % Účinnosť: 80 % Krytie: IP21S Trieda izolácie: F Priemer elektródy: 0.6-10.0 mm Rozmer: 480 x 240 x 370 mm	1	

Polyfúzna zváračka plastových rúr

STREND PRO



kód	popis	3	kg
213380	Príkon: 1 500 W Napätie / frekvencia: 230 V/50 Hz Čas tepelného ohrevu: < 15 min Regulátor teploty: 0 až 300 °C	3	5,330
213128	Nadstavec náhradný 20 mm	1	
213130	Nadstavec náhradný 25 mm	1	
213131	Nadstavec náhradný 32 mm	1	
213223	Nadstavec náhradný 40 mm	1	
213224	Nadstavec náhradný 50 mm	1	
213132	Nadstavec náhradný 63 mm	1	

Polyfúzna zváračka je určená na zahrievanie koncov termoplastických rúrok a tvaroviek za účelom ich pevného spojenia. Zváračka nachádza uplatnenie pri vykonávaní drobných inštalatérskych činností v domácnosti ako je napr. zariadenie nových rozvodov vody, výmeny častí potrubia apod.

Obsah balenia:

nadstavce 20-63 mm / nožnice na plastové rúrky / rukavice / skrutkovač / imbusový kľúč / meter

A) Force

B) Tecnica



Zváračací invertor

Int. kód	A MIN MAX	% TELWIN USE 20°C	A MAX 40°C EN 60974-1	Ø MIN MAX E	LxWxH mm
A) Force 145 116012	10-130	60%	125	1,6	300x125x225
A) Force 165 116194	10-150	60%	140	1,6	300x125x225
B) Tecnica 211/S 116015	10-130	90%	130	1,6	300x130x230
B) Tecnica 151/S 116058	10-150	88%	140	1,6	300x130x230
B) Tecnica 171/S 116022	15-180	65%	170	1,6	300x130x230

Pištoľ na tavné tyčinky



kód	popis		
213520	Menovitý príkon (zahratie) 60 W	1	0,440
213521	Menovitý príkon (zahratie) 80 W	1	0,440
	Napätie / frekvencia: 230 V / 50 Hz Menovitý príkon (udržanie teploty) 11 W Ø tavné tyčinky 11 ~ 11,5 mm Lepiaca teplota 195 °C Doba nahriatia 5 min.		

Pištoľ na tavné tyčinky



kód	popis		
213477	Napätie / frekvencia: 230 V / 50 Hz Menovitý príkon (zahratie) 80 W Menovitý príkon (udržanie teploty) 11 W Ø tavné tyčinky 11,5 mm Lepiaca teplota 200 °C Doba nahriatia 5 min.	1	0,583
	Prevádzková teplota môže dosiahnuť 150 až 200 °C.		

Pištoľ na tavné tyčinky



kód	popis		
213429	Príkon: 80 W Napätie / frekvencia: 230 V / 50 Hz 6x lepiaca tyčinka (11.2 x 150 mm) Použitie: drevo, plasty, textilie, kartón, obklady, keramika, koža...	1	0,560

Tavná tyčinka



kód	popis		
217590	100x08 mm		0.5kg
217565	100x11 mm		0.5kg
217589	200x11 mm		0.5kg
217588	200x08 mm		0.5kg

Pištoľ na tavné tyčinky



kód	popis		
213476	Napätie / frekvencia: 230 V / 50 Hz Menovitý príkon (zahratie) 55 W Menovitý príkon (udržanie teploty) 7 W Ø tavné tyčinky 11,5 mm Lepiaca teplota 200 °C Doba nahriatia 5 min.	1	0,375
	Prevádzková teplota môže dosiahnuť 150 až 200 °C.		

Tavná tyčinka



kód	popis		
2170335	200x11 mm / bal. 48ks	48	1,000

Pištoľ na tavné tyčinky



kód	popis		
213196	40 W / 230 V / 50 Hz 08-18 mm	12	0,400
213317	80 W / 230 V / 50 Hz 188 A	12	0,416

Tavná tyčinka, farebná

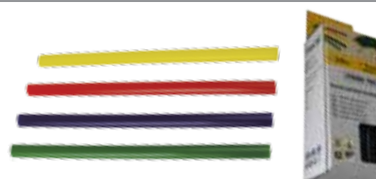

kód	popis		
2170778	100x7 mm / modrá / bal. 24ks	24	0,097
2170779	100x7 mm / zelená / bal. 24ks	24	0,097
2170780	100x7 mm / žltá / bal. 24ks	24	0,097
2170781	100x7 mm / červená / bal. 24ks	24	0,097
2170782	100x11 mm / modrá / bal. 24ks	24	0,226
2170783	100x11 mm / zelená / bal. 24ks	24	0,226
2170784	100x11 mm / žltá / bal. 24ks	24	0,226
2170785	100x11 mm / červená / bal. 24ks	24	0,226

Tavná tyčinka



kód	popis		
2170266	150x11 mm / bal. 6ks	6	0,094
2170267	200x11 mm / bal. 32ks	32	0,680

Trafopájka

STREND PRO



kód	popis		
213079	Napätie / frekvencia: 230 V / 50 Hz Príkon: 100 W	24	0,880

Trafopájka

LÍDO KOV



kód	popis		
213234	75 W	1	
213233	100 W	1	

Klamiarska spájkovačka

KAREL Konrad



kód	popis		
213076	75 W Konrad T-375	1	

Klamiarska spájkovačka

KAREL Konrad



kód	popis		
213043	100 W Konrad T-310	1	

Klamiarska spájkovačka

KAREL Konrad



kód	popis		
213044	380 W Konrad T-346	1	

Cin a Kalafonia



kód	popis		
214211	1,00 mm / 100g	1	
214263	1,50 mm / 100g	1	
214152	2,00 mm / 100g	1	
214824	2,00 mm / 500g	1	
215399	kalafonia, 40 g	1	
214089	kalafonia, 100 g	1	

Spájkovačka

STREND PRO



kód	popis		
213490	A) 40 W / 230 V / 50 Hz / 400 °C / 235 mm	1	0,280

Spájkovačka

STREND PRO



kód	popis		
213514	B) 80 W / 230 V / 50 Hz / 520 °C / 250 mm	1	0,350

Odsávačka cinu



kód	popis		
2170519	veľká nasávací sila; antistatický hrot; hrot odolný teplote hliník-plast	1	0,047

Skúšačka

EP Elektroplast v.d. PREŠOV



kód	popis		
213020	SN 2 • 12 V-50 V	1	0,400

Skúšačka

EP Elektroplast v.d. PREŠOV



kód	popis		
213072	SN 4 • 110 V-400 V	1	0,400

TEPLOVZDUŠNÉ PIŠTOLE

Pištoľ striekacia

STREND PRO



kód	popis		
115354	Príkion: 100 W 1x čistiaci kolík; 2x ventily; 1x 0,8 mm náhradná tryska Napätie / frekvencia 230 V / 50 Hz Zásobník farby 800 ml Max. prietok 300 ml / min	1	1,700

Pištoľ striekacia s kompresorom

STREND PRO



kód	popis		
115263	Výkon: 600 W Tlak (Bar): 0,1-0,2 Ø trysky: 1,5 - 2 mm Veľkosť nádoby: 1 lit. Max. prietok: 280-350 ml / min Otáčky: 28500 rpm Striekacia pištoľ s kompresorom je použiteľná pre nátery a nástreky na rôzne druhy áut, zariadení, nábytku, prístrojových dosiek a pod.	1	2,250

Pištoľ teplovzdušná



kód	popis		
213433	Príkion (zahriatie): 2000 W Napätie / frekvencia: 230 V / 50 Hz Teplota / Prúd vzduchu: I. 400° / 300l/m II. 600° / 500l/m Použitie: - odstránovanie starej farby, laku a podobne. - tvarovanie alebo zmršťovanie materiálov horúcim vzduchom.	8	

Pištoľ teplovzdušná

STREND PRO



kód	popis		
213428	Príkion: 2000 W Napätie / frekvencia 230V / 50 Hz Teplota: 350 °C / Nastavenie I; 550 °C / Nastavenie II 4x tryska, 3x škrabka hlavy	1	2,000

Pištoľ teplovzdušná

Burley
POWER TOOLS



kód	popis		
213413	Príkion: 2000 W Napätie / frekvencia: 230 V / 50 Hz Teplota: 50°C / Nastavenie I; 50 – 630°C / Nastavenie II; 50 – 630°C / Nastavenie III Objem vzduchu: 120 l / min-1 / Nastavenie 1; 240 l / min-1 / Nastavenie 2 360 l / min-1 / Nastavenie 3; 480 l / min-1 / Nastavenie 4; 550 l / min-1 / Nastavenie 5 Trieda ochrany: II dvojitá izolácia	8	1,650



Nabíjačka batérií

WORCRAFT
PROFESSIONAL

60 Ah



kód	popis		
118032	Nabíjací prúd ef/ari: 2 A Výstupné napätie: 6 V / 12 V Výkon: Max. 35 W Vhodné typy batérií: Všetky typy olovených batérií (WET, MF, Ca/Ca, AGM a GEL) Dĺžka kábla: 1,5 m Kapacita batérie: 3.0Ah-60 Ah	1	

Nabíjačka batérií

WORCRAFT
PROFESSIONAL

200 Ah



kód	popis		
118025	Výstupné napätie: 6 V / 12 V Nabíjací prúd ef/ari: 2 A / 10 A Výkon: Max. 180 W Vhodné typy batérií: Všetky typy olovených batérií (WET, MF, Ca/Ca, AGM a GEL) Dĺžka kábla: 1,5 m Kapacita batérie: 3.0Ah-200 Ah	1	

Nabíjačka batérií + ŠTARTÉR

WORCRAFT
PROFESSIONAL



kód	popis		
118048	Napätie / frekvencia 230 V / 50 Hz Max. nabíjací prúd: 18-40 A Nabíjacie napätie: 12-24 V Funkcia štart: áno	1	

Nabíjačka batérií

WORCRAFT
PROFESSIONAL

80 Ah



kód	popis		
118004	Napätie / frekvencia 230 V / 50 Hz Max. nabíjací prúd: 5 A Kapacita batérie: 16-80 Ah Nabíjacie napätie: 12 V	1	2,500

Štartovacie káble





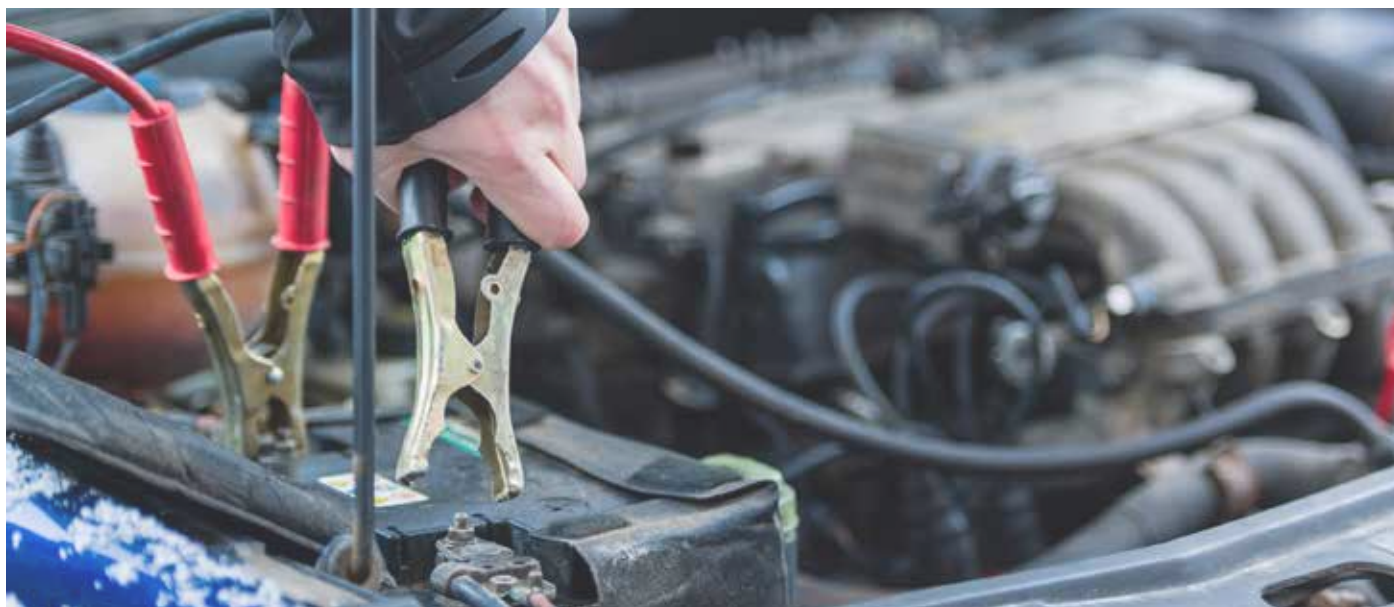









kód	popis		
116129	120 A	24	0,750
116031	200 A	10	0,725
116041	300 A	10	1,100
116034	400 A	10	2,250

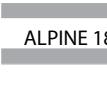

Nabíjanie

Nabíjanie a ŠTART

		NABÍJANIE 15h		ÚDRŽBA		ŠTART		5 min. pre nabíjanie + ŠTART		AUTOMATIKA				
		20 Ah	60 Ah	80 Ah	100 Ah	150 Ah	200 Ah	> 250 Ah	WET	GEL	ACM	START STOP	TRONIC	PULZ TRONIC
Nabíjanie	 DEFENDER 8 (6-12V) / int. kód 118021								•	•	•	•	✓	
	 AUTOTRONIC 25 BOOST (12-24V) / int. kód 118040								•	•	•	•	✓	
	 T-CHARGE 12 - EVO (12V) / int. kód 118043								•	•	•	•		✓
	 T-CHARGE 20 BOOST (12-24V) / int. kód 118024								•	•	•	•		
	 DOCTOR CHARGE 50 (6-12-24V) / int. kód 118026								•	•	•	•		✓
	 NEVADA (12V) / int. kód 118022								•					
	NEVADA (6-12V) / int. kód 118037													
	NEVADA (12-24V) / int. kód 118011													
	 TOURING 11 (6-12V) 55Ah / int. kód 118014									•				
	 TOURING 11 (6-12V) 55Ah / int. kód 118028									•	•	•	•	✓
	 TOURING 15 (12-24V) 115Ah / int. kód 118018													
	 ALPINE 15 BOOST (12-24V) / int. kód 118008									•				
	 ALPINE 18 BOOST (12-24V) / int. kód 118031													
	Nabíjanie a ŠTART	 LEADER 210 START (12-24V) / int. kód 118012								•				
 LEADER 400 START (12-24V) / int. kód 118016														
 DYNAMIC - 520 START (12-24V) 1000Ah / int. kód 118023									•					
 DYNAMIC - 620 START (12-24V) 1550Ah / int. kód 118009														

Olejevý kompresor, jednopiestový

STREND PRO®

Kompresor je určený pre generovanie stlačeného vzduchu zo vzduchom poháňaných nástrojov, ktoré môžu byť poháňané pomocou objemu vzduchu do cca. 270 l / min (napr. hustilka pneumatík, ofúkovacie pištole a striekacie pištole). Vzhľadom na obmedzený vzduchový výstup, nie je možné použiť kompresor na pohon nástrojov s veľmi vysokou spotrebou vzduchu (napríklad okružné brúsky, zbijacie kladivá).

Zariadenie je možné použiť iba pre úlohy, na ktoré je určený a zvládne ich. Každé iné použitie sa považuje za prípad zlého použitia.



kód	popis		
115060	Výkon: 2,5 HP / 1,8 kW; Napätie / frekvencia: 230 V / 50 Hz Nádoba: 24 lit.; Tlak: 9 bar; Otáčky: 2850 rpm	1	25,000
115005	Výkon: 2,5 HP / 1,8 kW; Napätie / frekvencia: 230 V / 50 Hz Nádoba: 50 lit.; Tlak: 8 bar; Otáčky: 2850 rpm	1	34,000
119234	Kompresorový olej 1000 ml	1	

Olejevý kompresor, dvojpístový

STREND PRO®

Tento malý kompresor má novátorský dizajn, excelentné spracovanie a výhody: kompaktná konštrukcia, nízka hmotnosť, jednoduchá obsluha, vysoká bezpečnosť a nízka hlučnosť. Jeho použitie má široký rozsah ako v obchode so strojmi, v chemickom priemysle, sprejovaní, dekorácii, automatickom riadiacom systéme a v ďalších odboroch, kde je požadovaný stlačený vzduch.



kód	popis		
115360	Výkon: 3 HP / 2,2 kW; Napätie / frekvencia: 230 V / 50 Hz Nádoba: 50 lit.; Tlak: 8 bar; Otáčky: 2850 rpm	1	37,000
119234	Kompresorový olej 1000 ml	1	

Vzduchový kompresor pre autá

STREND PRO®

kód	popis		
115002	Príkon: Príkon: 100 W Otáčky: 36 000 rpm Prietok vzduchu: 8 l/min Max. prevádzkový čas: 10 minút Dĺžka napájacieho kábla (230 V): 1.8 m Dĺžka napájacieho kábla (12 V): 3 m Dĺžka vzduchovej hadice: 50 cm Zaručená hladina akustického výkonu: 90 dB	1	

Bezolejový kufříkový kompresor

WORCRAFT PROFESSIONAL
8 bar

kód	popis		
115021	Príkon: 1100W; Sacia kapacita: 180 lit./min. Napätie / frekvencia: 230 V / 50 Hz. Hadica: 3 m; Tlak: 8 bar; Otáčky: 3550 rpm.	1	

Príslušenstvo: 1x pištoľ s manometrom / 2x konektor / fúkacia ihla / 2x adaptér / 3x nádstavec

Príklepový uťahovák

STREND PRO
PREMIUM



kód	popis		
115399	680 Nm; závit 1/4"; štvorhran 1/2"	1	2,100

voľnobežné otáčky: 7500 ot./min-1
priemer unášača nástroja: 1/2 (12mm)
max. priemer skrutky M18
dvojitý príklepový mechanizmus
nastavenie uťahovacieho momentu: 107Nm - 350Nm - 680Nm
prepínanie smeru otáčania
spotreba vzduchu: 113 l/min
max. pracovný tlak: 620 kPa
vzduchová vsuvka: 1/4

Pneumatický príklepový uťahovák je určený na uťahovanie a povoľovanie závitových spojov, napr. pri opravách automobilov, pri práci na ocelových konštrukciách a pod. Prednosťou pneumatického uťahováka je vysoký uťahovací moment a silný príklep, ktorý je umožnený vďaka dvom kladivám v príklepovom mechanizme náradia

Račňový uťahovák

STREND PRO
PREMIUM



kód	popis		
115398	64 Nm; závit 1/4"; štvorhran 1/2"	1	1,100

voľnobežné otáčky: 150 ot./min-1
priemer unášača nástroja: 1/2 (12mm)
nastavenie uťahovacieho momentu
prepínanie smeru otáčania
spotreba vzduchu: 141 l/min
max. pracovný tlak: 620 kPa
vzduchová vsuvka: 1/4

Pneumatický račňový uťahovák s hliníkovým telom je určený na uťahovanie a povoľovanie závitových spojov. Vďaka svojim rozmerom umožňuje prístup do ťažko prístupných miest (napr. pri opravách automobilov, práce na ocelových konštrukciách atď.). Prednosťou pneumatického račňového uťahovača je rýchlosť vykonanej práce

Príklepová sada

STREND PRO



kód	popis		
115397	17 dielna; 312 Nm; závit 1/2"	1	25,000

Voľnobežné otáčky: 7000 ot./min.
Príslušenstvo:
imbušový kľúč 4 mm, predlžovací nástavec 125 mm - 1/2", olejníčka, 1 ks vzduchová vsuvka
10 ks nástrčkových kľúčov 9,10,11,13,14,17,19,22,24,27 mm

Kvalitná **pneumatická** príklepová sada náradia. K tomuto setu je zdarma bohaté príslušenstvo obsahujúce imbušový kľúč, nástavec, nástrčkové kľúče a olejníčka.

Sada náradia ku kompresoru



kód	popis		
115274	5 dielna sada pištolí	1	

Pištoľ ofukovacia, pištoľ s manometrom, pištoľ striekacia, pištoľ čistiaca, hadica

Sada náradia ku kompresoru



kód	popis		
115400	3 dielna sada pištolí	1	

Pištoľ ofukovacia, pištoľ s manometrom, hadica

Pištoľ na pieskovanie



kód	popis		
115102	Nominálny tlak: 0.2-0.5 MPa; Max. tlak: 0.63 MPa	1	

Pištoľ na pieskovanie, striekanie a ofukovanie



kód	popis		
115110	Rýchle účinné pieskovanie tekutinou alebo vzduchom	1	

Pištoľ s manometrom



kód	popis		
115277	Nominálny tlak: 10 bar; Max. tlak: 12 bar	10	0,450

Pištoľ striekacia s nádobkou



kód	popis		
115272	nádoba 600 ml, plastová	20	0,900

- spotreba vzduchu: 14,5 cfm
- veľkosť trysky: štandardné: 1,4 mm / rozsah: 1,2-2,0 mm
- hmotnosť: 0,65 kg
- tlak vzduchu: 3 kg/cm²
- prívod vzduchu 1/4"

Pištoľ striekacia s nádobkou



kód	popis		
115361	nádoba 1000 ml, kovová	20	0,900

- spotreba vzduchu: 14,5 cfm
- veľkosť trysky: štandardné: 1,4 mm / rozsah: 1,2-2,0 mm
- hmotnosť: 0,65 kg
- tlak vzduchu: 3 kg/cm²
- prívod vzduchu 1/4"

Pištoľ ofukovacia



kód	popis		
115275	20 mm / ofukovacia	25	0,150

Adaptér a redukcia, Ms

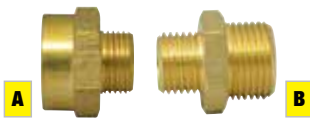

kód	popis		
115369	A) adaptér 1/2-3/8"	1	
115371	A) adaptér 1/4-3/8"	1	
115370	A) adaptér 3/8-1/2"	1	
115368	A) adaptér 3/8-1/4"	1	
115366	B) redukcia 1/4"	1	
115367	B) redukcia 1/4-3/8"	1	

Rýchlospojka, Ms



kód	popis		
115374	1/2", 13 mm	1	
115372	1/4", 06 mm	1	
115373	3/8", 09 mm	1	

Hadica pre kompresor s rýchlospojkou



kód	popis		
115362	05 m / 5x08 mm	1	
115363	10 m / 5x08 mm	1	
115364	05 m / 8x10 mm	1	
115365	10 m / 8x10 mm	1	

Nádoba na striekaciu pištoľ



kód	popis		
115265	plastová / 600ml	50	0,220

Pištoľ ofukovacia



kód	popis		
115282	50 mm / ofukovacia	25	0,150

Spojka na kompresor, Ms



kód	popis		
115305	A) 3/8"	1	
115382	B) 1/2", 13 mm	1	
115380	B) 1/4", 06 mm	1	
115381	B) 3/8", 09 mm	1	

Spojka na kompresor, Ms



kód	popis		
115377	A) 1/4", vonkajší závit	1	
115378	A) 3/8", vonkajší závit	1	
115379	B) 3/8", vnútorný závit	1	

Rýchlospojka, Ms



kód	popis		
115392	1/4", vnútorný závit	1	

Hadica pre kompresor s rýchlospojkou



kód	popis		
115395	10 m / 6x12 mm / max. 15 bar	1	
115396	10 m / 8x14 mm / max. 15 bar	1	

Pištoľ čistiaca



kód	popis		
115264	300 mm	10	0,700

Pištoľ ofukovacia



kód	popis		
115283	80 mm / ofukovacia	25	0,150

Spojka na kompresor, Ms

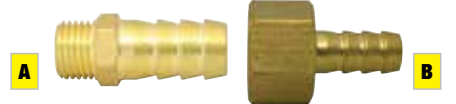

kód	popis		
115388	A) 1/4", 13 mm, vonkajší závit	1	
115384	A) 1/4", 06 mm, vonkajší závit	1	
115386	A) 1/4", 09 mm, vonkajší závit	1	
115383	A) 1/8", 06 mm, vonkajší závit	1	
115389	A) 3/8", 13 mm, vonkajší závit	1	
115385	A) 3/8", 06 mm, vonkajší závit	1	
115387	A) 3/8", 09 mm, vonkajší závit	1	
115390	B) 3/8", 6 mm, vnútorný závit	1	
115391	B) 3/8", 9 mm, vnútorný závit	1	

Rýchlospojka, Ms



kód	popis		
115376	1/2", vonkajší závit	1	
115375	1/4", vonkajší závit	1	
115309	3/8", vonkajší závit	1	

Brúška na sadrokartón



kód	popis		
113770	Výkon: 750 W Otáčky: 1500-2700 /min Priemer brúsnej podložky: 170 mm Priemer brúsneho papiera: 180 mm Priemer trubice: 32 mm	1	2,400
245535	Brusný papier P120	5	

Zariadenie je určené na brúsenie sadrokartónov, stropov, vnútorných a vonkajších stien, odstraňovanie zvyškov z podlahy, náterov, lepidiel, omietky a pod.
Zariadenie nie je vhodné na opracovanie objektov, ktoré obsahujú azbest.

Brúška na sadrokartón



kód	popis		
113769	Výkon: 600 W Otáčky: 600-1500 /min Priemer brúsenia: 215 mm Priemer brúsneho papiera: 225 mm Priemer trubice: 32 mm Dĺžka (bez predĺžovacej trubice): 1,10 /1,35 m Dĺžka (s predĺžovacou trubicou): 1,65 m	1	3,800
243534	Brusný papier P120	5	

Zariadenie je určené na brúsenie sadrokartónov, stropov, vnútorných a vonkajších stien, odstraňovanie zvyškov z podlahy, náterov, lepidiel, omietky a pod.
Zariadenie nie je vhodné na opracovanie objektov, ktoré obsahujú azbest.

Miešadlo elektrické na riedku zmes



Miešadlo slúži na rozmiešavanie tekutých a práškových stavebných materiálov, ako sú farby, malta, lepidlo, omietky a podobné substancie.

kód	popis		
213371	Príkon: 850 W Napätie / frekvencia: 230 V / 50 Hz Prevod: 1 Voľnobežné otáčky: 0-500 rpm Ochrana: dvojité izolácia / II Miešacie padlo: 120 mm	4	4,500
2160535	Náhradné miešacie pádlo	10	

Miešadlo elektrické na stredne hustú zmes



Miešaný materiál s vysokou viskozitou, malty, potery, rýchloschnúce sady, cement, betón, epoxidové živice, tesniace hmoty, živice a mnoho ďalších...

kód	popis		
213656	Príkon: 1400 W Napätie / frekvencia: 230 V / 50 Hz Prevod: 2 Voľnobežné otáčky: 0-480 / 0-680 rpm Ochrana: dvojité izolácia / II Miešacie padlo: 120 mm	4	
216238	Náhradné miešacie pádlo	10	

Miešadlo elektrické na stredne hustú zmes



Miešadlo slúži na rozmiešavanie tekutých a práškových stavebných materiálov, ako sú farby, malta, lepidlo, omietky a podobné substancie.

kód	popis		
213369	Príkon: 1400 W Napätie / frekvencia: 230 V / 50 Hz Prevod: 2 Voľnobežné otáčky: 0-480 rpm Ochrana: dvojité izolácia / II Miešacie padlo: 140 mm	2	7,000
2160536	Náhradné miešacie pádlo	10	

Miešadlo elektrické na hustú zmes



Miešadlo slúži na rozmiešavanie tekutých a práškových stavebných materiálov, ako sú farby, malta, lepidlo, omietky a podobné substancie.

kód	popis		
213372	Príkon: 1600 W napätie: 230 V / 50 Hz Prevod: 2 Voľnobežné otáčky: 180-460 / 300-700 rpm Ochrana: dvojité izolácia / II Miešacie padlo: 160 mm	2	8,500
2160537	Náhradné miešacie pádlo	10	



Miešačka na maltu

STREND PRO®



kód	popis		
112658	120 lit., 550 W Max. objem materiálu 80 lit. Max. hmotnosť materiálu 175kg Otáčky: 2800 rpm Otvor bubna 400 mm	1	44,000
112657	160 lit., 650 W Max. objem materiálu 130 lit. Max. hmotnosť materiálu 235kg Otáčky: 2800 rpm Otvor bubna 400 mm	1	52,000
112659	180 lit., 800 W Max. objem materiálu 150 lit. Max. hmotnosť materiálu 265kg Otáčky: 2800 rpm Otvor bubna 400 mm	1	56,000

Miešačka na maltu



kód	popis		
112452	130 lit., 0800 W, 230 V / 50 Hz	1	52,000
112453	155 lit., 1000 W, 230 V / 50 Hz	1	56,000
112454	190 lit., 1000 W, 230 V / 50 Hz	1	67,000

Zariadenie bolo vyvinuté výhradne pre domáce použitie, na uľahčenie murárskych prác okolo domu. Je vhodné na miešanie betónu, malty a iných stavebných materiálov.

Elektrický navijak pre domáce použitie

STREND PRO®



kód	popis		
112563	Príkon: 500 W Napätie / frekvencia: 230 V / 50 Hz Prúd: 2,18 A Max. zaťaženie: pre jeden kábel 125 kg / pre dvojitý kábel 250 kg Rýchlosť navinu: pre jeden kábel 8 ml/min / pre dvojitý kábel 4 ml/min Výška zdvihu: pre jeden kábel 12 m / pre dvojitý kábel 6 m	1	11,000
112564	Príkon: 1000 W Napätie / frekvencia: 230 V / 50 Hz Prúd: 4,35 A Max. zaťaženie: pre jeden kábel 250 kg / pre dvojitý kábel 500 kg Rýchlosť navinu: pre jeden kábel 8 ml/min / pre dvojitý kábel 4 ml/min Výška zdvihu: pre jeden kábel 12 m / pre dvojitý kábel 6 m	1	17,500
112565	Príkon: 1300 W Napätie / frekvencia: 230 V / 50 Hz Prúd: 5,65 A Max. zaťaženie: pre jeden kábel 400 kg / pre dvojitý kábel 800 kg Rýchlosť navinu: pre jeden kábel 9 ml/min / pre dvojitý kábel 4,5 ml / min Výška zdvihu: pre jeden kábel 12 m / pre dvojitý kábel 6 m	1	20,000

Miešačka na maltu, 150 litrov, 1.1 kW



kód	popis		
112006	Celkový príkon / prúd: 1,1 kW / 2,8A Napätová sústava: 3 / N / PE AC 50 Hz 400 / 230 V Sieť: TN - S Užitočný objem bubna: 150 dm ³	1	153,000

Miešačka je určená na výrobu betónových zmesí a čerstvej malty triedy B15 až B50. Miešačka je prevozná s ručne ovládaným sklápaním bubna. Bubon je poháňaný elektro-motorom cez prevodovku.

Svietidlo LED



10W LED
800 LUMENS
5-12m
130°
1,5 m

kód	popis		
2170786	10W, 230V, SMD, hliník, ovládač, teplota farby: 6400K, 800 lm	1	0,800

Svietidlo LED



20W COB LED
1600 LUMENS
3 m

kód	popis		
2170787	20W, 230V, L-3m, stojan, SMD tvrdené sklo, hliník, 1600 lm	1	4,500

Svietidlo LED



30W LED
2400 LUMENS
3 m

kód	popis		
2170788	30W, 230V, L-3m, SMD, tvrdené sklo, hliník, 2400 lm	1	2,100

Svietidlo



kód	popis		
217320	36W, 230V, eSave	1	2,760

Svietidlo



kód	popis		
217297	36W, 230V, eSave	1	4,770

Svietidlo



2x36w

kód	popis		
217263	2x36W, 230V, eSave	1	6,780

Svietidlo



500W

kód	popis		
217303	Halogen, 500W	16	0,970
217308	Halogen, 500W, so senzorom	1	1,160

Svietidlo LED



6W

kód	popis		
217309	LED 28, 230V, 6W	16	0,970

Svietidlo WorkLight



kód	popis		
217234	L-5 m, s magnetom	10	0,700

Svietidlo



kód	popis		
217310	230V, L-5m	1	1,200

Svietidlo LED



kód	popis		
217235	LED 28; 3,6V/1600mAh	1	0,750

Svietidlo LED



A
B

kód	popis		
217260	A) 60 LED, NiMh 7,2V/800mAh	1	0,840
217313	B) 51+9 LED; 3,6V/1800mAh	1	0,880

Svietidlo LED



kód	popis		
217261	LED 60, 230V/50Hz, L-5m	1	0,700

Svietidlo



kód	popis		
217312	08W, L-5m, na 230V	1	0,560
217298	11W, L-5m, na autozástrčku	1	0,670

Svietidlo SpotLight LED



**NABÍJATELNÁ
+ NABÍJAČKA**

kód	popis		
217223	3x LED / nabíjacia	8	1,375

Svietidlo SuperBright LED



kód	popis		
217229	6xHatLED, 3xD	1	0,100

Svietidlo eXlight LED 2v1



kód	popis		
217228	12xLED, 3xD	1	0,100

Svietidlo a lampáš v jednom. / Možnosť nastavenia 3 úrovni jasů zapnutím 4, 8 alebo 12 LED. / S vymeniteľným gumovým držadlom / max. diaľka osvetlenia: 50 m / svetelný tok 40 lm

Svietidlo FlashLight LED



kód	popis		
217230	3xHatLED, 4xAA	1	

Svietidlo FlashLight



kód	popis		
217232	3xLED Ø 5 mm 2xAA 2,4V max. diaľka svietenia: 10 m svetelný tok: 15 lm	1	
217231	3xLED Ø 5 mm 3xD 3,6V max. diaľka svietenia: 15 m svetelný tok: 30 lm	1	

Svietidlo LED



kód	popis		
2170333	24xLED + 3xLED Ø 5 mm vrátane 3xAAA batérií 1,5V doba svietenia: 36 hod. balenie 12ks	1	0,133

Svietidlo BiCycle LED



kód	popis		
217227	3xAAA, 3x LED	1	0,084

Svietidlo BiCycle LED



kód	popis		
2170269	3xAAA, 4x LED	1	0,115

Svietidlo BiCycle LED



kód	popis		
2170272	3xAA+Backlight 2AA, 5x LED	1	0,166

Svietidlo LED



kód	popis		
217259	LED 12, 400mA	1	0,430

Lampa kempingová s kompasom



kód	popis		
217494	žiarivka, 4 batérie 1,5V	1	0,550

Svietidlo HeadLight LED



kód	popis		
2170843	3+2x LED Super jasné LED / 3xAAA 2 funkcie: 3x biele LED svetlo, 2x červená LED dióda Rozmery: 6,5x4,1x4,0 cm	1	

Svietidlo HeadLight LED



kód	popis		
2170846	8x LED Super jasné LED / 3xAAA 3 funkcie: 2x LED, 4x LED, 8x LED Rozmery: 7,8x4,8x5,1 cm	1	

Svietidlo HeadLight LED



kód	popis		
2170844	1W/3W LED Super jasné LED / 3xAAA S optickou šošovkou Multi funkcie: 100% svetlo / 50% svetla / OFF Rozmery: 6,2x4,8x4,8 cm	1	

Svietidlo vodeodolné HeadLight LED



kód	popis		
2170845	3W CREE LED XP-E Super jasné červené LED / 3xAAA Svetelný tok: 120 lm Max. diaľka osvetlenia: 80 m Doba osvetlenia: 100% 6h Multi funkcie: 100% svetlo / 25% svetla / OFF Rozmery: 6,2x4,8x4,8 cm	1	

Svietidlo HeadLight LED



kód	popis		
217233	12xLED, 3xAAA	1	0,141

Stolový ventilátor



32 W

kód popis

2171110 Priemer ventilátora: 23 cm

Príkon: 32 W

Napätie / frekvencia: 230 V / 50 Hz

- 2 rýchlosti

- bez časovača

- PP lopatky



1



Stolový ventilátor



38 W

kód popis

2171110 Priemer ventilátora: 30 cm

Príkon: 38 W

Napätie / frekvencia: 230 V / 50 Hz

- 3 rýchlosti

- bez časovača

- PP lopatky



1



Stojanový ventilátor



42 W

kód popis

217542 Priemer ventilátora: 40 cm

Príkon: 42 W

Napätie / frekvencia: 230 V / 50 Hz

Celková výška: 1.3 m

- 3 rýchlosti

- bez časovača

- PP lopatky



1



Stojanový ventilátor s diaľkovým ovládačom



45 W

kód popis

2171111 Priemer ventilátora: 40 cm

Príkon: 45 W

Napätie / frekvencia: 230 V / 50 Hz

Celková výška: 1.5 m

- široký rozsah točenia

- 3 rýchlosti

- časovač 1 hodina

- PP lopatky



1



Ohrievač olejový

STREND PRO®



kód	popis	1	kg
2211114	A) 400x300x620 mm	1	

Tepelný výkon: 0,8 kW / 1,2 kW / 2,0 kW
Napätie/frekvencia: 230 V ~ 50 Hz
Počet článkov: 9
Dĺžka kábla: 1,5 m

2211115	B) 470x300x620 mm	1	
---------	-------------------	---	--

Tepelný výkon: 1,0 kW / 1,2 kW / 2,0 kW
Napätie/frekvencia: 230 V ~ 50 Hz
Počet článkov: 11
Dĺžka kábla: 1,5 m

- 4 pojazdové kolieska a držadlo na prenášanie pre ľahkú manipuláciu; 3 úrovne ochrany proti prehriatiu; plynule regulovateľný termostat; nevysúša vzduch; vysoká tepelná zotrvačnosť

Ohrievač halogénový

STREND PRO®



kód	popis	1	kg
2211117	400x300x600 mm	1	

Tepelný výkon: 400 W / 800 W / 1200 W
Napätie/frekvencia: 230 V ~ 50 Hz
Oscilačný uhol: 90°
Napájaci kábel: 1,4 m

- ochrana proti prevrnutiu
- vysoká účinnosť ohrevu
- tichý chod
- možnosť oscilácie

Infražiarič

STREND PRO®



kód	popis	1	kg
2211116	530x130x120 mm	1	

Tepelný výkon: 500 W / 1000 W / 1500 W
Napätie/frekvencia: 230 V ~ 50 Hz

- možnosť umiestnenia na stenu
- masívne kovové telo
- možnosť nastavenia sklonu
- rýchly sálový ohrev
- pracuje na princípe ohrevu infračerveného žiarenia

Termoventilátor

STREND PRO®



kód	popis	1	kg
2211120	220x130x270 mm	1	

Tepelný výkon: 1000 W / 2000 W
Napätie/frekvencia: 230 V ~ 50 Hz
Dĺžka kábla: 1,2 m
Režimy: ventilátor, tepelný vzduch, horúci vzduch

- termostat
- regulovateľný výkon
- masívne plastové telo
- vysoká účinnosť
- automatické vypnutie pri prehriati

Termoventilátor

STREND PRO®



kód	popis	1	kg
2211118	200x150x300 mm	1	

Tepelný výkon: 1000 W / 2000 W
Napätie/frekvencia: 230 V ~ 50 Hz
Dĺžka kábla: 1,4 m
Režimy: ventilátor, tepelný vzduch, horúci vzduch

- termostat
- regulovateľný výkon
- masívne plastové telo
- vysoká účinnosť
- automatické vypnutie pri prehriati

Termoventilátor

STREND PRO®



kód	popis	1	kg
2211119	200x150x250 mm	1	

Tepelný výkon: 750 W / 1500 W
Napätie/frekvencia: 230 V ~ 50 Hz
Oscilačný uhol: 90°
Dĺžka kábla: 1,4 m
Režimy: ventilátor, tepelný vzduch, horúci vzduch

- termostat
- regulovateľný výkon
- ochrana proti prehriatiu
- ochrana proti prevrnutiu
- možnosť oscilácie

Konvektor - Standard

STREND PRO®



kód	popis	1	kg
2211123	550x200x400 mm	1	

Tepelný výkon: 0,75 kW / 1,25 kW / 2,0 kW
Napätie/frekvencia: 230 V ~ 50 Hz
Dĺžka kábla: 1,4 m

- plynule regulovateľný termostat
- regulovateľný výkon
- automatické vypnutie v prípade prehriatia
- tepelná poistka
- rýchly ohrev vzduchu

Konvektor - Turbo

STREND PRO®



kód	popis	1	kg
2211121	700x200x450 mm	1	

Tepelný výkon: 0,75 kW / 1,25 kW / 2,0 kW
Napätie/frekvencia: 230 V ~ 50 Hz
Dĺžka kábla: 1,4 m

- plynule regulovateľný termostat
- rýchly ohrev vzduchu
- regulovateľný výkon
- kontrola ohrievania
- automatické vypnutie v prípade prehriatia
- tepelná poistka

Konvektor - Turbo

STREND PRO®



kód	popis	1	kg
2211122	600x250x200 mm	1	

Tepelný výkon: 0,75 kW / 1,25 kW / 2,0 kW
Napätie/frekvencia: 230 V ~ 50 Hz
Dĺžka kábla: 1,6 m

- plynule regulovateľný termostat
- automatické vypnutie v prípade prehriatia
- konvektor s ventilátorom na vykurovania miestnosti
- zariadenie je ľahko prenosné
- plynule nastaviteľná požadovaná izbová teplota na teplotnom prepínači

Ohrievač elektrický

STREND PRO®



kód	popis		
119195	360x320x425 mm	1	

Max. tepelný výkon: 3 kW
3 stupňe výkonu: 40 W, 2000 W, 3000 W
Napätie/frekvencia: 230 V ~ 50 Hz
Prietok vzduchu: 400 m³/hod
Sietový kábel: štandardný 1,5 m

- termostat; vbudovaný mechanizmus prevratenia zaisti vypnutie v uhle nad 50°; kapacita poistky musí byť nad 10 A; odporúčame pre maliarov, omietkárov, obkladačov, inštalatérov atď...; určený na vykurovanie zatvorených priestorov (sklady, obchody, pivnice...)

Ohrievač elektrický

STREND PRO®



kód	popis		
119192	382x325x445 mm	1	

Max. tepelný výkon: 5 kW
3 stupňe výkonu: 40 W, 2500 W, 5000 W
Napätie/frekvencia: 380-400 V ~ 50 Hz
Prietok vzduchu: 470 m³/hod
Sietový kábel: 3-žilový, nie je súčasťou balenia

- plynule regulovateľný termostat; kapacita poistky musí byť nad 10 A; odporúčame pre maliarov, omietkárov, obkladačov, inštalatérov atď...; určený na vykurovanie zatvorených priestorov (sklady, obchody, pivnice...)

Ohrievač elektrický

STREND PRO®



kód	popis		
119193	450x355x498 mm	1	

Max. tepelný výkon: 9 kW
3 stupňe výkonu: 55 W, 4500 W, 9000 W
Napätie/frekvencia: 380-400 V ~ 50 Hz
Prietok vzduchu: 670 m³/hod
Sietový kábel: 3-žilový, nie je súčasťou balenia

- plynule regulovateľný termostat; kapacita poistky musí byť nad 32 A; odporúčame pre maliarov, omietkárov, obkladačov, inštalatérov atď...; určený na vykurovanie zatvorených priestorov (sklady, obchody, pivnice...)

Ohrievač elektrický

STREND PRO®



kód	popis		
119194	520x390x548 mm	1	

Max. tepelný výkon: 15 kW
3 stupňe výkonu: 95 W, 7500 W, 15000 W
Napätie/frekvencia: 380-400 V ~ 50 Hz
Prietok vzduchu: 1250 m³/hod
Sietový kábel: 3-žilový, nie je súčasťou balenia

- plynule regulovateľný termostat; kapacita poistky musí byť nad 32 A; odporúčame pre maliarov, omietkárov, obkladačov, inštalatérov atď...; určený na vykurovanie zatvorených priestorov (sklady, obchody, pivnice...)

Ohrievač elektrický

STREND PRO®



kód	popis		
119012	197x210x303 mm	1	

Max. tepelný výkon: 2 kW
Napätie/frekvencia: 230 V ~ 50 Hz
Prietok vzduchu: 152 m³/hod
Dĺžka kábla: 1,5 m

- kapacita poistky musí byť nad 32 A; odporúčame pre maliarov, omietkárov, obkladačov, inštalatérov atď...; určený na vykurovanie zatvorených priestorov (sklady, obchody, pivnice...); oceľová konštrukcia s tepelne odolným lakom

Ohrievač LPG

STREND PRO®



kód	popis		
119055	Kategória plynu: I3B/P	1	

Max. tepelný výkon: 14 kW
Spotreba plynu: 1018 g/hod.
Napätie/frekvencia: 230 V ~ 50 Hz
Prietok vzduchu: 300 m³/hod
Tlak plynu: 0,7 bar

119237 Kategória plynu: I3B/P 1

Max. tepelný výkon: 30 kW
Spotreba plynu: 2160 g/hod.
Napätie/frekvencia: 230 V ~ 50 Hz
Prietok vzduchu: 1000 m³/hod
Tlak plynu: 1,5 bar

- regulátor a hadica súčasťou balenia; vhodný do menších vetraných priestorov, kde je potrebné v krátkom čase dosiahnuť zvýšenie teploty; výrobok je vybavený multifunkčným elektromagnetickým ovládacím zariadením, ktoré umožňuje vypnutie zariadenia pri zhasnutí plameňa alebo pri prehriati

Ohrievač naftový

STREND PRO®



kód	popis		
119051		1	

Max. tepelný výkon: 20 kW
Výkon: 160 W
Napätie/frekvencia: 230 V ~ 50 Hz
Prietok vzduchu: 430 m³/hod
Tlak: 0,25 bar
Objem nádrže: 20 lit.
Max. spotreba paliva: 1,85 l/hod.

- je určený predovšetkým na ohrievanie budov, ktoré práve stavajú alebo opravujú; vzduchové čerpadlo; rýchle zapálenie; regulátor obmedzenia teploty; ohrievač je vybavený ističom, ktorý ho chráni pred poškodením

Plynový ohrievač

STREND PRO®



kód	popis		
2210775A	Izbový / 73x42x44 cm	1	10,000

Tepelný výkon: 4,2 kW/h; 2,8 kW/h; 1,4 kW/h
Spotreba: 0,3 kg/h; 0,2 kg/h; 0,1 kg/h
Druh plynu: bután (G30), propán (G31) a ich kombinácia

Piezoelektrické zapálenie / Ochrana proti zhasnutiu plameňa
Poistka tepelná a proti náklonu / Kovové telo / 3 infračervené horáky s vysokou tepelnou účinnosťou / 3 stupne nastavení / S medeným plynovým ventilom

Terasový ohrievač

STREND PRO®

materiál: nerez alebo oceľ
základňa: 454x086 mm
podstavec: 378x780 mm
hlavný stĺp: 056x850 mm
horák: 262x520 mm
clona: 260x220 mm
oporný stĺp: 20x20x720 mm



výška: 2241 mm
palivo: LPG,
propán-bután
spotreba:
450-870 g/h

kód	popis		
2210774	12 kW / nerezové prevedenie	1	18,000

Kábel predĺžovací

Ø medeného kábla 1,5 mm
max. záťaž navinutého: 1000 W
max. záťaž rozvinutého: 3000 W



NOVINKA



kód	popis		
213031	7,5 m, 4x zásuvka	1	

Kábel predĺžovací, gumový

Ø medeného kábla 1,5 mm
max. záťaž navinutého: 1000 W
max. záťaž rozvinutého: 3000 W



NOVINKA



kód	popis		
213274	20 m, 4x zásuvka	1	
213277	30 m, 4x zásuvka	1	
213273	50 m, 4x zásuvka	1	

Kábel predĺžovací

Ø medeného kábla 1,5 mm
max. záťaž navinutého: 1100 W
max. záťaž rozvinutého: 3680 W



kód	popis		
213053	25 m, 4x zásuvka	1	4,100
213057	35 m, 4x zásuvka	1	5,500
213059	50 m, 4x zásuvka	1	7,100

Kábel predĺžovací s vypínačom



kód	popis		
213335	1,5 m / 3x zásuvka	50	0,295
213336	3,0 m / 3x zásuvka	40	0,427
213337	5,0 m / 3x zásuvka	40	0,560
213338	7,0 m / 3x zásuvka	20	0,730
213339	1,5 m / 4x zásuvka	50	0,300
213340	3,0 m / 4x zásuvka	40	0,440
213341	5,0 m / 4x zásuvka	40	0,580
213342	7,0 m / 4x zásuvka	20	0,750
213343	1,5 m / 5x zásuvka	50	0,330
213344	3,0 m / 5x zásuvka	40	0,450
213345	5,0 m / 5x zásuvka	40	0,640
213346	7,0 m / 5x zásuvka	20	0,780

Ø medeného kábla 1,5 mm / max. záťaž 2300 W

Kábel predĺžovací bez vypínača



kód	popis		
213322	1,5 m / 3x zásuvka	50	0,266
213323	3,0 m / 3x zásuvka	50	0,380
213324	5,0 m / 3x zásuvka	30	0,573
213325	7,0 m / 3x zásuvka	20	0,705
213326	1,5 m / 4x zásuvka	50	0,280
213327	3,0 m / 4x zásuvka	40	0,415
213328	5,0 m / 4x zásuvka	40	0,560
213329	7,0 m / 4x zásuvka	20	0,730
213330	1,5 m / 5x zásuvka	50	0,350
213331	3,0 m / 5x zásuvka	50	0,390
213332	5,0 m / 5x zásuvka	40	0,603
213333	7,0 m / 5x zásuvka	1	0,760
213334	10,0 m / 6x zásuvka	20	1,005

Ø medeného kábla 1,5 mm / max. záťaž 2300 W

Kábel predĺžovací

Ø medeného kábla 1,5 mm
max. záťaž 2300 W



kód	popis		
213347	10 m	10	1,260
213268	20 m	5	2,340
213270	30 m	5	3,400

ZÁHRADNÁ TECHNIKA



Motorová kosačka s pojazdom

STREND PRO®



4v1

kód	popis		
111196	Výkon 5 HP Objem: 139 cm³ Otáčky: 2800 rpm Nádrž: 1,3 lit Rezná výška: 25 až 70 mm / 8 stupňův Šírka záberu: 46 cm Pre plochy do: 1200 m ² Zberný kôš: 60 lit. Skelet: kovový Pohon: s pojazdom 4 v 1	1	34,000
1110681	náhradný nôž 46 cm		

Motorová kosačka s pojazdom

STREND PRO®



4v1

kód	popis		
111197	Výkon 6 HP Objem: 173 cm³ Otáčky: 2750 rpm Nádrž: 1,5 lit Rezná výška: 25 až 80 mm / 8 stupňův Šírka záberu: 51 cm Pre plochy do: 1600 m ² Zberný kôš: 60 lit. Skelet: kovový Pohon: s pojazdom 4 v 1	1	35,000
1110681	náhradný nôž 46 cm		

Motorová kosačka 40 BS

STREND PRO®



2v1



kód	popis		
111165	Výkon 3,5HP / Motor Briggs&Stratton Objem: 123 cm³ Otáčky: 2850 rpm Nádrž: 1,0 lit Rezná výška: 25 až 75 mm Šírka záberu: 40 cm Pre plochy do: 800m ² Zberný kôš: 50 lit. Podvozok: ocelový plech Bez pohonu	1	28,000
1110666	Náhradný nôž 40 cm	1	

Motorový olej BOBOR pre dvojtaktné motory



kód	popis		
1110699	100 ml	20	
1110183	500 ml		
1110693	1000 ml	12	

Motorový olej BOBOR pre štvortaktné motory



kód	popis		
1110184	500 ml		
1110696	1000 ml	12	

Elektrická kosačka



2v1

kód	popis		
111161	Príkion: 1000W / 230V Napätie: 230V/50Hz Šírka záberu: 30,5 cm Nastavenie výšky: každé koleso Zberný kôš: 28 lit. Podvozok: plast	1	11,500

Elektrická kosačka



kód	popis		
111209	Príkion: 1300W / 230V Napätie: 230V/50Hz Šírka záberu: 38 cm Nastavenie výšky: každé koleso Zberný kôš: 35 lit. Podvozok: plast	1	

Elektrický prevzdušňovač VT 120

STREND PRO®



kód	popis		
111284	Príkion: 1200 W Napätie / frekvencia: 230 V / 50 Hz Otáčky bez záťaže: 4500 rpm Šírka záberu: 34 cm Pracovná výška: 3, 4, 8 mm Zberný kôš: 25 lit. Podvozok: plast	1	13,000

Elektrický krovínorez EBC 100

STREND PRO®



kód	popis		
111035	Príkion: 1000 W Napätie / frekvencia : 230 V / 50 Hz Otáčky: 9000-10500 rpm Šírka záberu: 23-35 cm Priemer nylonu: 1,4 mm	1	5,600
1130069	Náhradný kryt		
1130068	Náhradný set krytov 62-67-68-44-66		
1130070	Náhradný nôž		

Motorový krovinořez

STREND PRO



42.7CC

kód	popis		
111403	Výkon: 1,4 kW Motor: dvojitaktný Objem: 52 cm³ Otáčky: 7500 rpm Nádrž: 1,2 lit Karburátor: membranový Šírka záberu: 42 cm Priemer nylonu: 2,6 mm	1	7,800
1130122	Popruh dvojramenný		
1130097	Náhradný nôž		
1130095	Náhradná hlava		

Motorový krovinořez WORCRAFT PROFESSIONAL



kód	popis		
111029	Príkion: 1,1 kW Motor: dvojitaktný Objem: 42.7 cm³ Otáčky: 10500 rpm Karburátor: membranový Čepel: 23 cm Šírka záberu: 42 cm	1	9,600
Príslušenstvo: 1x hlava, 1x nôž, 1x popruh, 1x kryt			

Motorový krovinořez WORCRAFT PROFESSIONAL



kód	popis		
111105	Príkion: 1,6 kW / Motor dvojitaktný Objem: 51.7 cm³ Otáčky: 9000 rpm Otáčky bez záťaže: 3200 rpm Nádrž: 1100 ml Karburátor: membranový Čepel: 26 cm Šírka záberu: 43 cm	1	
Príslušenstvo: 1x hlava, 1x nôž, 1x popruh, 1x kryt			

Náhradné nože k benzínovým krovinořezom

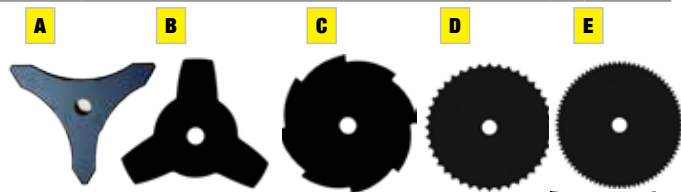

kód	popis		
1130097	A) 3 zubý, 250x3.0 mm		
1130404	B) 3 zubý, 255x1.4 mm		
1130405	C) 8 zubý, 255x1.4 mm		
1130406	D) 40 zubý, 255x1.4 mm		
1130124	E) 80 zubý, 255x1.4 mm		

Náhradná diely

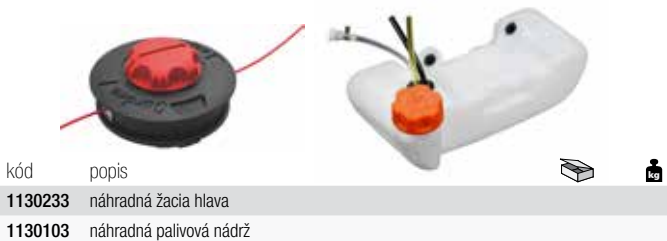

kód	popis		
1130233	náhradná žacia hlava		
1130103	náhradná palivová nádrž		

Popruhy



kód	popis		
1130105	A) jednoramenný		
1130122	B) dvojramenný, extra komfortný		

Elektrický vyžinač, teleskopický

WORCRAFT PROFESSIONAL

500W



kód	popis		
111113	Príkion: 500 W Napätie / frekvencia : 230 V / 50 Hz Otáčky bez záťaže: 9300 rpm Šírka záberu: 30 cm Priemer nylonu: 1,5 mm	1	0,000
1110288	náhradná hlava	1	
1110255	náhradný kryt	1	

Prevodové plastické mazivo



kód	popis		
1110698	50g	1	
Určené pre všetky krovinořezy a vyžinače			

Motorový rotavátor



kód	popis		
111478	Výkon 2,2 kW / Motor Briggs&Stratton 500	1	38,000

Objem: 140 cm³
Počet rotačných jednotiek: 4
Pracovný záběr: 55 cm

Rotavátor je určený na obhospodarovanie malých záhrad a viníc. Je vhodný na preoranie pôdy pred sadením, ako aj na ničenie burín a iné spôsoby obrábania pôdy. S pripojenou prídavnou prevodovkou sa stáva vhodným na plečkovanie, orbu, oborávanie a na ničenie buriny.

Motorový rotavátor



kód	popis		
111007	Výkon 4 kW / Motor Briggs&Stratton 675	1	41,000

Objem: 196 cm³
Počet rotačných jednotiek: 6
Pracovný záběr: 80 cm

Rotavátor je určený na obhospodarovanie malých záhrad a viníc. Je vhodný na preoranie pôdy pred sadením, ako aj na ničenie burín a iné spôsoby obrábania pôdy. S pripojenou prídavnou prevodovkou sa stáva vhodným na plečkovanie, orbu, oborávanie a na ničenie buriny.

Prevodový olej Cinol PP 80W-90



kód	popis		
1110513	1000 ml		

Príslušenstvo k rotavátorom



kód	popis		
111015	A) Kultivátor, kompletný	1	
111437	B) Kultivátor, rotačný	1	
111128	B) Koleso nafúkovacie	1	

Príslušenstvo k rotavátorom

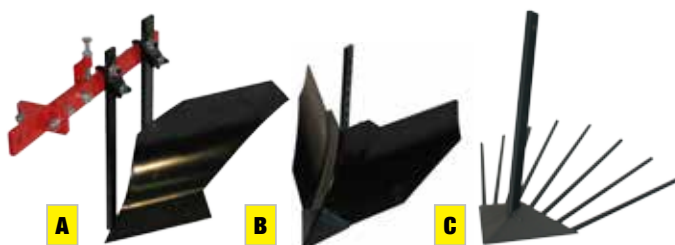

kód	popis		
111142	A) Pluh oborávací, pravý	1	
111146	B) Pluh vyorávací	1	
111424	C) Vyorávač, na zemiaky	1	

Motorový zemný vrták



kód	popis		
111421	Výkon: 1,4 kW / Motor dvojtaktný	1	9,500
	Objem: 52 cm³ Otáčky: 7500 rpm Nádž: 1,2 lit Karburátor: membranový Vrták: Max. Ø 300 mm, dĺžka 80 cm		
1110711	Vrták náhradný do zeme, Ø 100 mm, dĺžka 80 cm	1	
1110700	Vrták náhradný do zeme, Ø 150 mm, dĺžka 80 cm	1	
1110701	Vrták náhradný do zeme, Ø 200 mm, dĺžka 80 cm	1	
1110080	Vrták náhradný do zeme, Ø 300 mm, dĺžka 80 cm	1	

PLOTOSTRIHY A NOŽNICE / HEDGE TRIMMERS AND SCISSORS

Motorový plotostrih

STREND PRO®



kód	popis		
111420	Výkon: 0,6 kW / Motor dvojitaktný Objem: 22,5 cm³ Otáčky: 7500 rpm Nádrž: 0,6 lit Karburačtor: membranový Dĺžka lišty: 75 cm	1	5,400

Elektrický plotostrih

WORCRAFT
PROFESSIONAL



kód	popis		
111588	Prikon: 600 W Napätie / frekvencia: 230 V / 50 Hz Otáčky: 1700 / min Dĺžka lišty: 51 cm Dĺžka zuba 16 mm	1	
1110270	Lišta náhradná	1	

Elektrický plotostrih

STREND PRO®



kód	popis		
113787	Prikon: 550W / + teleskopická rukoväť Napätie / frekvencia: 230 V / 50 Hz Otáčky: 1600 rpm Dĺžka lišty: 56 cm Max. Ø strihu: 16 mm Dĺžka zuba 16 mm	1	3,600

Elektrický plotostrih

STREND PRO®



kód	popis		
113786	Prikon: 550 W Napätie / frekvencia: 230 V / 50 Hz Otáčky: 1600 min-1 Dĺžka lišty: 61 cm Dĺžka zuba 16 mm	1	3,600

Akumulátorové nožnice

STREND PRO®



kód	popis		
113784	Napätie batérie DC 10,8 V / 3x lišta / + teleskopická rukoväť	1	1,400

Typ batérie: Li-Ion
Otáčky bez záťaže: 1100 - 1800 rpm
Dĺžka strihu: 20 cm
Max. Ø strihu: 8 mm
Max. Ø rezu: drevo 80 mm / kov 7 mm
Šírka strihu: 16 cm
Kapacita batérie: 1,3 Ah

Akumulátorové nožnice

STREND PRO®



kód	popis		
113785	Napätie batérie DC 7,2 V / 2x lišta / otočná teleskopická rukoväť	1	1,400

Typ batérie: Li-Ion
Otáčky bez záťaže: 1000 rpm
Dĺžka strihu: 17 cm
Max. Ø strihu: 8 mm
Šírka strihu: 10 cm
Kapacita batérie: 1,3 Ah

Akumulátorové nožnice

WORCRAFT
PROFESSIONAL



kód	popis		
111147	Napätie batérie 7,2 V + teleskopická rukoväť	1	

Typ batérie: Li-Ion
Kapacita batérie: 1300 mAh
Doba nabíjania: 3-5 hodín
Otáčky bez záťaže: 1100 rpm
Doba chodu na jedno nabitie: 40 minút
Dĺžka čepele na trávu: 83 mm
Dĺžka čepele na krikky: 135 mm

Motorová reťazová píla

NOVINKA



kód	popis		
114499	Výkon: 2,0 kW / Motor dvojitaktný Objem: 46 cm³ Otáčky: 11 000 rpm Otáčky bez záťaže: 3 300 ± 300 rpm 2x nádrž: palivová 550 ml / olejová 260 ml Reťaz: 3/8" x 0.05" Dĺžka lišty: 46 cm	1	
114016	Reťaz náhradná 18"	1	
114310	Lišta náhradná 18"	1	

Elektrická reťazová píla

2000W



kód	popis		
111084	Príkon: 2000 W Napätie: 230 V / 50 Hz Otáčky reťaze: 12 m/s Dĺžka lišty: 40 cm	1	0,000
1130142	Reťaz náhradná 16" / 3/8" x 0.05"		

Elektrický brúsič pilových reťazí

WORCRAFT
PROFESSIONAL

180W



kód	popis		
111698	Príkon: 180 W; Napätie: 230 V / 50 Hz Otáčky: 6300 rpm Priemer kotúča: 10 cm Hrúbka kotúča: 3,5-4,5 mm	1	3,400
1130155	Uhlík náhradný	1	

Reťazový olej



kód	popis		
1110697	1000 ml	12	

Určený pre všetky druhy elektrických a benzínových reťazových pí

Motorová reťazová píla

STREND PRO



kód	popis		
114201	Výkon: 2,3 kW / Motor dvojitaktný Objem: 58 cm³ Otáčky: 7500 rpm 2x nádrž: palivová 550 ml / olejová 260 ml Reťaz: 0,825 x 0,147 cm Dĺžka lišty: 50 cm	1	5,500
Rukoväť s antivibračným systémom / Zotrvačná bezpečnostná brzda / Elektronický vznetový systém Automatické mazanie reťaze			
1130087	Reťaz náhradná 18" / 46,00 cm / šírka článku 1,47 mm / počet článkov 72		
1130089	Reťaz náhradná 20" / 50,80 cm / šírka článku 1,47 mm / počet článkov 76		
1130086	Lišta náhradná 18"		
1130088	Lišta náhradná 20"		

Elektrická multifunkčná píla

STREND PRO

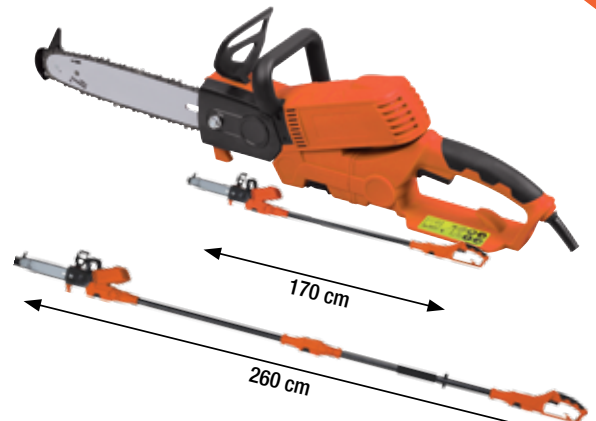

kód	popis		
111277	Príkon: 900 W Napätie / frekvencia: 230 V / 50 Hz Otáčky reťaze: 15 m/s Dĺžka lišty: 19-23,5 cm Teleskopická rukoväť: 1,7-2,6 m	1	5,000
Automatické mazanie reťaze			

Elektrický brúsič pilových reťazí SH 230

STREND PRO



kód	popis		
113143	Príkon: 230 W Napätie / frekvencia: 230 V / 50 Hz Otáčky: 3000 min ⁻¹ Priemer kotúča: 14,5 cm Hrúbka kotúča: 3,2-6 mm	1	5,800
223180	kotúč na reťaz 145 x 3,2 x 22,3 mm		
223027	kotúč na reťaz 145 x 6,0 x 22,3 mm		
223452	kotúč na reťaz 145 x 4,7 x 22,3 mm		

Vertikálna hydraulická štiepačka

STREND PRO®

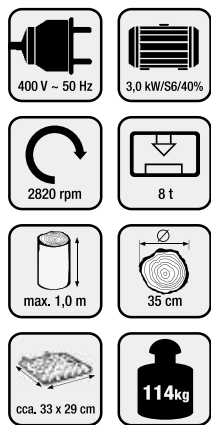

Náhradný nôž

kód	popis	1	kg
114005	Výkon 3 kW	1	114,000

Napätie / frekvencia: 400 V / 50 Hz
 Sila na štiepacom klinu 80 kN (8t)
 Max. dĺžka polena: 1050 mm
 Min. / Max. priemer polena: 120 / 350 mm
 Dĺžka zdvihu klinu: 500 mm
 Rýchlosť pri chode: ca. 0,04 m/sek.
 Rýchlosť pri spätnom chode: ca. 0,15 m/sek.
 Hydraulický olej: max 5 l
 Hydraulický tlak: 26 MPa (260 bar)
 Rozmery (dxšxv): 77x54x152 cm

114355	Nôž plochý	1	
114049	Nôž krížový	1	
114297	Nôž klinový, plochý	1	
114052	Náhradné koliesko	1	
1110185	Olej Cinol OH HM 46 HLP, 1 liter, do štiepačiek		

- trojfázový elektromotor
 - pracuje sa s ňou rýchlejšie ako s horizontálnou
 - vhodná na dlhšie a hrubšie polená
 - polená netreba dvíhať vysoko
 - možnosť nastavenia stroja na krátke polená
 - celokovová konštrukcia umožňuje bezpečné a pohodlné naštiepanie dreva
 - zmenou pozície štiepacieho stola (tri polohy) je možné meniť dĺžku štiepaných polien
 - zrýchlený spätný pohyb klinu zvyšuje produktivitu práce
- súčasť výbavy:** krížový štiepací klin na štiepanie malých a stredných polien
- kolieska, ktoré sa pri štiepaní zatiahujú a tak nie sú pri práci zaťažované

Okružná píla, cirkulárka

STREND PRO®



kód	popis	1	kg
114004	Výkon 4,5 kW	1	96,000

Napätie / frekvencia: 400 V / 50 Hz
 Otáčky bez záťaže: 1490 rpm
 Priemer dreva: 30-240 mm
 Priemer pilového listu: 700 mm
 Upínací priemer: 30 mm
 Rozmery (dxšxv): 107x69x132 cm

223558	Náhradný kotúč	1	
114067	Náhradné koleso	1	

Vhodná na priečne pílenie dreva na domáce a nekomerčné využitie. Umožňuje rýchlo narezať veľké množstvo polien s priemerom 3 - 24 cm a dĺžkou 20 - 100 cm. Používanie je veľmi jednoduché a vďaka masívnemu krytu kotúča a jeho elektrickej brzde aj bezpečné. K maximálnej pracovnej pohode a bezpečia významne prispieva ergonomická kolíska.

Vertikálna hydraulická štiepačka

STREND PRO®

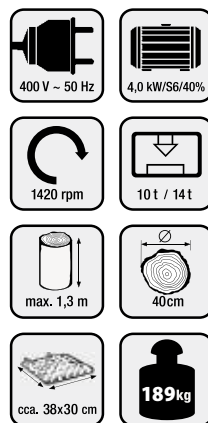

	114296	114392
Sila na štiepacom klinu:	100 kN (10t)	140 kN (14t)
Napätie / frekvencia:	400 V / 50 Hz	400 V / 50 Hz
Výkon:	4 kW	4 kW
Max. dĺžka polena:	1300 mm	1330 mm
Min. / Max. priemer polena:	120 / 400 mm	120 / 400 mm
Dĺžka zdvihu klinu:	515 mm	515 mm
Rýchlosť pri chode:	cca. 0,05 m/sek.	cca. 0,05 m/sek.
Rýchlosť pri spätnom chode:	cca. 0,25 m/sek.	cca. 0,25 m/sek.
Hydraulický olej:	max 10 l	max 8 l
Hydraulický tlak:	21,4 MPa (214 bar)	21,4 MPa (214 bar)
Rozmery (dxšxv):	58x53x153 cm	65x41x118 cm

114104	Nôž plochý	
114058	Nôž krížový	
114274	Nôž klinový, plochý / pre 114296	
114297	Nôž klinový, plochý / pre 114292	
114061	Náhradné koliesko	
1110185	Olej Cinol OH HM 46 HLP, 1 liter, do štiepačiek	

- trojfázový elektromotor
 - pracuje sa s ňou rýchlejšie
 - vhodná na dlhšie a hrubšie polená
 - polená netreba dvíhať vysoko
 - možnosť nastavenia stroja na krátke polená
 - celokovová konštrukcia umožňuje bezpečné a pohodlné naštiepanie dreva
 - zmenou pozície štiepacieho stola (tri polohy) je možné meniť dĺžku štiepaných polien
 - zrýchlený spätný pohyb klinu zvyšuje produktivitu práce
- súčasť výbavy:** krížový štiepací klin na štiepanie malých a stredných polien
- kolieska, ktoré sa pri štiepaní zatiahujú a tak nie sú pri práci zaťažované

Horizontálna štiepačka

STREND PRO®



kód	popis	1	kg
114006	Výkon: 2200 W	1	

Napätie / frekvencia: 230 V/50 Hz
 Otáčky bez záťaže: 2800 rpm
 Sila na štiepacom klinu: 6T
 Dĺžka polena: max 520 mm
 Priemer polena: 50-250 mm
 Trieda ochrany: B
 Stupeň ochrany: IP 54

Štiepačka dreva je určená výhradne na štiepanie už napíleného palivového dreva s max. dĺžkou 520 mm.

Elektrický drvič

WORCRAFT
PROFESSIONAL

2500W



kód	popis		
111701	Príkion: 2500 W Napätie: 230 V / 50 Hz Otáčky bez záťaže: 3800 rpm Rezný priemer: 45 mm	1	14,000

1130182	Nôž náhradný	1	
---------	--------------	---	--

Zariadenie používajte na drvenie len týchto materiálov:

Vetvičky a konáre (max. priemer 45 mm).
Odpad z prerezaných kríkov.
Odpad zo strihania živých kríkov.
Rastlinný materiál a iný záhradný odpad.
Listy a korene rastlín (pred drvením odstráňte zeminu z koreňov).

Elektrický drvič

STREND PRO



kód	popis		
119164	Príkion: 2500 W Napätie: 230 V / 50 Hz Otáčky bez záťaže: 4050 min ⁻¹ Rezný priemer: 40 mm Zberný kôš: 50 lit.	1	14,000

119186	50 lit. nádoba zberná, náhradná	1	
--------	---------------------------------	---	--

119167	Náhradný nôž	1	
--------	--------------	---	--

Zariadenie používajte na drvenie len týchto materiálov:

Vetvičky a konáre (max. priemer 40 mm)
Odpad z prerezaných kríkov
Odpad zo strihania živých kríkov
Rastlinný materiál a iný záhradný odpad
Listy a korene rastlín (pred drvením odstráňte zeminu z koreňov).

Elektrický fukár a vysávač na lístie

STREND PRO



kód	popis		
111303	Príkion: 2600 W / Napätie: 230 V / 50 Hz	1	4,500

Výkonnosť sania: 14m³/min

Otáčky bez záťaže: 14000 min⁻¹

Rýchlosť vzduchu: 250 km/h

Mulčovací pomer: 10:1

Zberný kôš: 45 lit.

Motorový rosič

STREND PRO



kód	popis		
256678	Výkon: 1,63 kW / Motor dvojtaktný	1	10,500

Objem: 41.5 cm³

Otáčky: 6000 rpm

Nádž na postrek: 14 lit

Horizontálny dosah: až 12 m

Rozptýlené množstvo prášku: 6 kg / min

Prenosné flexibilné a vysoko efektívne zariadenie pre použitie v prevencii chorôb rastlín a ničenie škodcov v rozsiahlych plantážach, poliach a v ovocných sadoch. Môže byť tiež použitý pre aplikáciu herbicídov, hygienu a prevenciu pred epidémiou, hnojenie a aplikáciu tuhých granúl atď.

Motorový rosič s pomocným čerpadlom

STREND PRO



kód	popis		
256689	Výkon: 1,63 kW / Motor dvojtaktný	1	14,500

Objem: 41.5 cm³

Otáčky: 6000 rpm

Nádž na postrek: 14 lit

Horizontálny dosah: až 12 m

Rozptýlené množstvo prášku: 6 kg / min

Prenosné flexibilné a vysoko efektívne zariadenie pre použitie v prevencii chorôb rastlín a ničenie škodcov v rozsiahlych plantážach, poliach a v ovocných sadoch. Môže byť tiež použitý pre aplikáciu herbicídov, hygienu a prevenciu pred epidémiou, hnojenie a aplikáciu tuhých granúl atď.

Ponorné čerpadlo

STREND PRO®

Model drenážneho čerpadla V série je ideálny pomocník na odvodňovanie. Písmeno „V“ označuje jedinečnú konštrukciu filtra a hrubosť vysoko efektívnej plochy čerpadla. Čerpadlo dokáže pracovať bezpečne a efektívne pri rýchlom toku vďaka jeho vlastnosti „kompletnej hlavy“. Konštrukcia čerpadla je navrhnutá tak, aby pripomínala široký tunel, čo pomáha pri sprostredkovaní kvapaliny s dlhšími, alebo hrubšími vláknami. Spodná sacia konštrukcia čerpadla z nerezovej ocele a špeciálnej liatiny železa umožňuje čerpadlu kompletne vypustenie a vysokú odolnosť proti opotrebovaniu a korózii. Plavákový spínač môže zapnúť, alebo vypnúť čerpadlo na základe zmeny hladiny vody. Zariadenie je vybavené chráničom motora, ktorý automaticky preruší napájanie čerpadla v prípade ohrozenia prehriatím, alebo pred vysokým prídomom, čo umožňuje bezpečné a spoľahlivé použitie čerpadla aj v náročných podmienkach.

Nerez

kód	popis		
119150	Príkonný: 1100 W Vhodné do septiku Napätie: 230 V / 50 Hz Maximálny prietok: 16800 l/hod Maximálny výtlak: 8 m Maximálna hĺbka ponoru: 9 m Max. Ø častíc: 35 mm Vonkajší priemer: 50 mm	1	24,000

Ponorné čerpadlo

STREND PRO®
Nerez
Nevhodné do septiku

Napätie: 230 V / 50 Hz
Max. Ø častíc: 35 mm
Maximálna teplota vody 35 °C
Pripájacie hadice:
1" 1-1/4" 1-1/2" Závitový koniec



kód	popis		
119118	Príkonný: 750 W Maximálny prietok: 13500 l/h Maximálny výtlak: 8 m Maximálna hĺbka ponoru: 8 m	1	6,000
119119	Príkonný: 1100 W Maximálny prietok: 16000 l/h Maximálny výtlak: 9,5 m Maximálna hĺbka ponoru: 8 m	1	4,800
119173	koleno náhradné	1	0,087

- najmä ako pivničné čerpadlo do kalnej vody
- pri namontovaní do šachty čerpadlo zaisťuje ochranu pred záplavami
- na presun vody z jedného miesta na druhé napr. v domácnosti, poľnohospodárstve, záhradníctve, inštalatérstve a pod.

Ponorné čerpadlo

STREND PRO®
Plast
Nevhodné do septiku

Napätie: 230 V / 50 Hz
Maximálna hĺbka ponoru: 7 m
Max. Ø častíc: 1-8-35 mm
Maximálna teplota vody 35 °C
Pripájacie hadice:
1-1/2" Závitový koniec



Čerpadlo je možné nastaviť na 3 velkostné režimy zberu častíc: 1, 8 a 35 mm.



kód	popis		
119030	Príkonný: 400 W Maximálny prietok: 7500 l / h Maximálny výtlak: 5 m	1	5,000
119174	Príkonný: 750 W Maximálny prietok: 12500 l / h Maximálny výtlak: 8 m	1	5,000
119038	Príkonný: 900 W Maximálny prietok: 13000 l / h Maximálny výtlak: 9 m	1	5,000

- najmä ako pivničné čerpadlo do kalnej vody
- pri namontovaní do šachty čerpadlo zaisťuje ochranu pred záplavami
- na presun vody z jedného miesta na druhé napr. v domácnosti, poľnohospodárstve, záhradníctve, inštalatérstve a pod.

Ponorné čerpadlo

STREND PRO®
Plast
Nevhodné do septiku

Napätie: 230V/50Hz
Max. Ø častíc: 5 mm
Maximálna teplota vody 35°C
Pripájacie hadice:
1" 1-1/4" 1-1/2" Závitový koniec



kód	popis		
119115	Príkonný: 400 W Maximálny prietok: 7000 l/h Maximálny výtlak: 7,5 m Maximálna hĺbka ponoru: 7 m	1	4,800
119116	Príkonný: 750 W Maximálny prietok: 11000 l/h Maximálny výtlak: 9 m Maximálna hĺbka ponoru: 8 m	1	4,800
119173	koleno náhradné	1	0,087

- na čerpanie vody z pivnice
- rôzne využitie v domácnosti, poľnohospodárstve, záhradníctve, inštalatérstve a pod.
- nízka hmotnosť a jednoduchá obsluha
- chránené tepelnou ochranou proti prehriatiu
- dĺžka elektrického kábla: 10 m

Vibračné čerpadlo

STREND PRO®
Nevhodné do septiku

Napätie: 230 V / 50 Hz
Max. výtlak: A) 60 m B) 70 m C) 50 m
Maximálna hĺbka ponoru: 5 m
Pripájacie hadice: 1/2"

Vibračné elektrické čerpadlo je určené na čerpanie vody z jám a studní. Čerpadlo má vnútorný priemer presahujúci 100 mm a dokáže prečerpať sladkú vodu pri maximálnej teplote 40° z rôznych vodných nádrží. Táto voda môže byť použitá na zalievanie a polievanie súkromných trávnikov a záhrad, alebo na iné domáce potreby. Čerpadlo sa nesmie používať na čerpanie pitnej vody. Elektrický vodivý časti čerpadla sú dvojito izolované.

Hliník

A
B/C

kód	popis		
119153	A) Príkonný: 280 W / Max. prietok: 1080l/h / kábel 10 m	1	12,000
119187	B) Príkonný: 600 W / Max. prietok: 1400 l/h / kábel 10 m	1	21,000
119045	B) Príkonný: 600 W / Max. prietok: 1400 l/h / kábel 20 m	1	21,000
119039	C) Príkonný: 300 W / Max. prietok: 1200 l/h / kábel 10 m	1	

Ponorné čerpadlo

STREND PRO®
Plast
Nevhodné do septiku

Napätie / frekvencia: 230 V / 50 Hz
Maximálny prietok: 4500 l/hod
Maximálna hĺbka: 7 m
Pripájacie hadice:
1" Závitový koniec
Max. Ø častíc: 2 mm



kód	popis		
119117	Príkonný: 350 W	1	4,500

- v domácnosti a záhrade na čerpanie dažďovej vody
- nízka hmotnosť a jednoduchá obsluha
- potrubie je vybavené viacerými odpadovými rúrami
- tepelnou ochranou proti prehriatiu
- dĺžka elektrického kábla: 10 m

Domáca vodáreň

STREND PRO®



kód	popis		
119044	Príkon: 1000 W Napätie: 230 V / 50 Hz Max. prietok: 3500 l/h Maximálna hladina: 44 m Otáčky: 2800 min-1 Max. nasávací výška: 8 m Hadicová prípojka: 1" Tlak: 4,4 bar Nádoba: 24lit.	1	

- na zavlažovanie, zalievanie parkov a záhrad / - na prevádzku postrekovačov trávnikov
- s použitím predfiltra na čerpanie vody z rybníkov, potokov, dažďovej vody, vodných nádrží a studní

Domáca vodáreň

STREND PRO®



kód	popis		
119044	Príkon: 1000 W Napätie: 230 V / 50 Hz Max. prietok: 3400 l/h Maximálna hladina: 44 m Otáčky: 2850 min-1 Max. nasávací výška: 8 m Hadicová prípojka: 1" Tlak: 1,5 - 3 bar Nádoba: 40lit.	1	

- na zavlažovanie, zalievanie parkov a záhrad / - na prevádzku postrekovačov trávnikov
- s použitím predfiltra na čerpanie vody z rybníkov, potokov, dažďovej vody, vodných nádrží a studní

Jazierkový vysávač



kód	popis		
119197	Príkon: 1400 W / Sací príkon: 160 W Napätie: 230V/50Hz Objem nádrže: 30 lit. Max. sacia hĺbka: 1,5 m Max. prietok vzduchu: 45 l/s Podtlak: 17 kPa Sacia hadica: 4m x 35mm Odtoková hadica: 2m x 54m Dĺžka kábla: 4,5 m	1	

Použitie: Na mokré i suché vysávanie. Vysávač je určený na vysávanie a výtah materiálov a nehorľavých tekutín, ktoré neohrozujú ľudský život. Príslušenstvo: 1. Odtoková hadica 2. Sacia hadica 3. Filter textilný 4. Predlžovacie rúry 5. Špongia 6. Hlavica okrúhla 7. Hlavica podlahová 8. Hlavica plochá 9. Hlavica jazierková 10. Vrečko na odpad

1130310	Hlavica jazierková
1130312	Hadica vypúšťacia
1130302	Špongia
1130308	Hlavica okrúhla
1130311	Hadica sacia
1130309	Hlavica podlahová
1130307	Filter textilný
1130306	Vrečko na odpad

Motorové čerpadlo

STREND PRO®



kód	popis		
119175	Výkon: 5,5 kW	1	24,000
119243	náhradná hadica; 1", L- 4 m	1	
119244	náhradná hadica; 1", L- 7 m	1	

Zapaľovanie: magnetický spínač
Max. prietok : 35 m² / h
Otáčky: 3600 rpm
Nádrž: 3,6 lit
Max. nasávací výška: 7 m
Max. výtlak: 26 m

Záhradné čerpadlo

STREND PRO®



kód	popis		
119151	Príkon: 1000 W Napätie: 230 V / 50 Hz Max. prietok: 3300 l/h Max. Ø častíc: 20 mm Max. výtlak: 42 m Dĺžka kábla: 1,2 m Max. nasávací výška: 8 m	1	7,700

Čerpadlo je určené na čerpanie čistej vody na domáce použitie, ako napríklad: - zavlažovanie
- čerpanie vody zo studní / - čerpanie vody z bazéna, záhradného jazierka, a nádrží
Maximálna povolená teplota čerpanej vody je 35 °C

Jazierkové čerpadlo



NOVINKA

kód	popis		
119247	Prikon: 25 W Napätie / frekvencia: 230 V/ 50 Hz Max. prietok: 1500 l/h Max. výtlak: 1,8 m Max. hĺbka: 2 m Dĺžka kábla: 10 m Max. teplota vody: 35°C Hadicová prípojka: 1/2", 3/4" Stupeň ochrany: IPX8	1	
119245	Prikon: 8 W Napätie / frekvencia: 230 V/ 50 Hz Max. prietok: 600 l/h Max. výtlak: 1,3 m Max. hĺbka: 2 m Dĺžka kábla: 10 m Max. teplota vody: 35°C Hadicová prípojka: G 1" Stupeň ochrany: IPX8	1	

- Čerpadlo je vhodné na čerpanie vody vo fontánach, kaskádach a jazierkach.

Ponorné čerpadlo, do studne



NOVINKA

kód	popis		
119241	Prikon: 750 W Napätie / frekvencia: 230 V/ 50 Hz Max. prietok: 41.5 l/min Max. výtlak: 61 Max. hĺbka: 40 m Dĺžka kábla: 15 m Max. teplota vody: 35°C Hadicová prípojka: G 1" Šírka: Ø 95 mm Dĺžka: 485 mm Stupeň ochrany: IP68 Trieda izolácie: B Prevádzkový tlak: max. 4 bar	1	

- Čerpadlo je vhodné na čerpanie čistej vody a chemicky neagresívnych kvapalín.

Automatická tlaková jednotka



NOVINKY

kód	popis		
119005 A)	Prikon: 1100 W Napätie / frekvencia: 230 V/ 50 Hz Max. prúdové zaťaženie: 10 A Trieda ochrany: IP65 Max. prevádzkový tlak: 10 bar Max. teplota vody: 60°C Počiatočný tlak: 1,5-3 bar Hadicová prípojka: R 1"	1	
119023 B)	Prikon: 2200 W Napätie / frekvencia: 230 V/ 50 Hz Max. prúdové zaťaženie: 30 A Trieda ochrany: IP65 Max. prevádzkový tlak: 10 bar Max. teplota vody: 60°C Počiatočný tlak: 2,2 bar Hadicová prípojka: R 5/4"	1	

- zariadenie domácej vodárne, automatická prevádzka čerpadla a vodárne, zásobovanie vodou, zavlažovanie, posilnenie tlaku v systéme
 - vhodná pre povrchové aj ponorné jednofázové čerpadlá
 - vhodná pre reguláciu tlaku bez potreby tlakovej nádoby

Ponorné čerpadlo, do studne



NOVINKA

kód	popis		
119242	Prikon: 750 W Napätie / frekvencia: 230 V/ 50 Hz Max. prietok: 63 l/min Max. výtlak: 85 Max. hĺbka: 40 m Dĺžka kábla: 20 m Max. teplota vody: 35°C Hadicová prípojka: G 1" Šírka: Ø 75 mm Dĺžka: 1316 mm Stupeň ochrany: IP68 Trieda izolácie: B Prevádzkový tlak: max. 4 bar	1	
119021	Prikon: 1100 W Napätie / frekvencia: 230 V/ 50 Hz Max. prietok: 47 l/min Max. výtlak: 123 Max. hĺbka: 40 m Dĺžka kábla: 20 m Max. teplota vody: 35°C Hadicová prípojka: G 1" Šírka: Ø 87 mm Dĺžka: 1188 mm Stupeň ochrany: IP68 Trieda izolácie: B Prevádzkový tlak: max. 4 bar	1	

- Čerpadlo je vhodné na čerpanie čistej vody, ktorej teplota je nižšia ako 40 °C alebo iných kvapalín s podobnými fyzikálnymi a chemickými vlastnosťami ako má voda, hodnota PH je medzi 6.8-8.
 - Obsah pevných častíc vo vode by mal byť nižší ako 0,1% (kvalitatívny podiel) a priemer menší ako 0,2 mm.

Vysokotlakový čistič

WORCRAFT
PROFESSIONAL

2100W



INDUKČNÝ MOTOR
EXTRA TICHÝ -
BEZUHLIKOVÝ MOTOR -
DLHŠIA ŽIVOTNOSŤ MOTORA -

NOVINKA



kód	popis	1	kg
117008	Prikon: 2100 W Napätie / frekvencia: 230 V / 50 Hz Max. tlak: 165 bar Max. Prietok: 7.2 l/min Dĺžka kábla: 5 m Dĺžka hadice na navijáku: 8 m - prírodné tyče vyrobené z ocele Funkcia: Autostop Obsah balenia: 1ks rotačná kefa, 1ks čistiaca kefa, 1ks zabudovaná nádobka na saponát, 1ks rýchlospojka, 1ks striekacia pištoľ s rotačnou nastaviteľnou tryskou	1	20,000
117002	Rotačná kefa	1	
117029	Okrúhla kefa	1	
117030	Hadica 8 m	1	
117031	Predlžovacia hadica 8 m	1	
117032	Čistiaca kefa	1	
117033	Striekacia pištoľ	1	
117034	Rýchlospojka	1	
117035	Nádoba na čistiaci prostriedok	1	
117005	Hadica na čistenie potrubia 7,5 m	1	
117010	Tyč striekacej pištole	1	
117009	Tyč striekacej pištole s tryskou	1	

Vysokotlakový čistič je zariadenie pre rýchle a účinné čistenie vozidiel, strojov, lodí, budov a pod. Používajte len čistiace prostriedky, ktoré odporučá výrobca prístroja, a dodržiavajte jeho pokyny o používaní.

Vysokotlakový čistič

WORCRAFT
PROFESSIONAL

1400W



kód	popis	1	kg
117028	Prikon: 1400 W Max. prietok : 7 l/min Napätie: 230 V / 50 Hz Max. tlak: 105 bar	1	5,300
1130231	náhradný uhlík	1	

Vysokotlakový čistič je zariadenie pre rýchle a účinné čistenie vozidiel, strojov, lodí, budov a pod.. Prilepené nečistoty sa odstraňujú za použitia čistej vody a chemických detergentov. Pri práci s chemickými detergentmi používajte len také, ktoré sú biologicky odbúrateľné. Motory vozidiel čistite len v priestoroch vybavených otvormi na olej.



Motorová elektrocentrála

WORCRAFT
PROFESSIONAL

2200W



kód	popis	1	kg
118050	Motor: 4-taktný, jednovalec Chladenie motora: vzduchom Výkon motora: 4 kW (5,5 HP) Otáčky motora: 3600 rpm Pomer kompresie: 8:5:1 Štartovanie: ručne Objem nádrže: palivová 15 lit. / olejová 0,6 lit. Trvalý výkon: 2000 W Max. výkon: 2200 W Menovitý prúd: 8,7 A Napätie / frekvencia: 230 V / 50 Hz Automatická regulácia napätia AVR	1	45,000
118053	Voltmeter	1	

Kontrolka oleja / Alarm pri nízkej hladine oleja / Funkcia automatického vypnutia pri nízkej hladine oleja

Motorová elektrocentrála

WORCRAFT
PROFESSIONAL

3850W



kód	popis	1	kg
118051	Motor: 4-taktný, jednovalec Chladenie motora: vzduchom Výkon motora: 4 kW (5,5 HP) Otáčky motora: 3600 rpm Pomer kompresie: 8:5:1 Štartovanie: ručne Objem nádrže: palivová 15 lit. / olejová 0,6 lit. Trvalý výkon: 3100 W Max. výkon: 3850 W Menovitý prúd: 12,1 A Napätie / frekvencia: 230 V / 50 Hz Automatická regulácia napätia AVR	1	48,000
118054	Voltmeter	1	

Kontrolka oleja / Alarm pri nízkej hladine oleja / Funkcia automatického vypnutia pri nízkej hladine oleja / Nafúkovacie kolieska

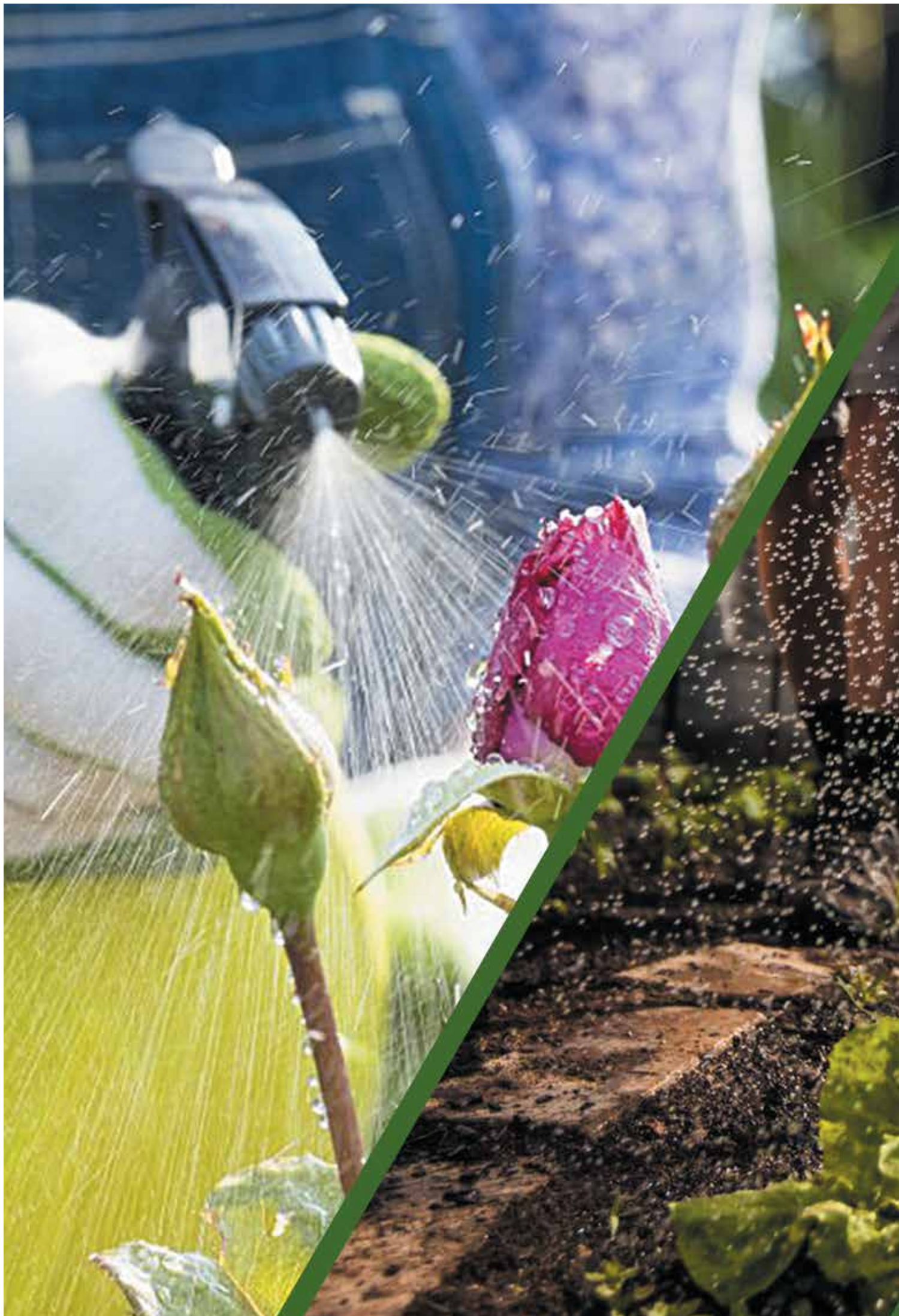

ZÁHRADA



Pílka skladacia



kód	popis		
226373	90 mm	10	0,160

Pílka skladacia



kód	popis		
226233	150 mm	6	0,291

Pílka skladacia



kód	popis		
226238	180 mm	6	0,297

Pílka skladacia



kód	popis		
226374	200 mm	6	0,180

Pílka skladacia



kód	popis		
226436	180 mm	24	0,390

Pílka záhradnícka



kód	popis		
226124	380 mm, vymeniteľná čepeľ	1	0,890

Pílka zlodejka



kód	popis		
226304	250 mm	10	0,170
226004	300 mm	10	0,200

Pílka s púzdom



kód	popis		
226487	240 mm	6	0,388

Pílka prerezávací s púzdom



kód	popis		
226202	240 mm	6	0,361
226121	270 mm	6	0,388

Pílka prerezávací s púzdom



kód	popis		
226289	270 mm	6	0,500

Pílka s púzdom



kód	popis		
226375	270 mm	6	0,220

Pílka záhradná s púzdom



kód	popis		
226525	150 mm	36	0,333
226526	250 mm	36	0,360

Pílka prerezávací s púzdom



kód	popis		
226288	240 mm	6	0,472

Pílka Shark, na palicu



- reže oboma smermi
- nepotrebuje ostrenie



kalené zuby
UltraSharp

kód	popis		
226392	320 mm	50	0,200

Pílka prerezávací na násadu



kód	popis		
226200	370 mm	24	0,300

Pílka na palicu na násadu



kód	popis		
226165	370 mm, s nožom	10	1,200

Pílka prerezávací



kód	popis		
226484	350 mm	1	0,438

Pílka na palicu



kód	popis		
226384	400 mm	50	0,400

List pilový



kód	popis		
226403	530 mm	40	0,050
226404	610 mm	48	0,057
226405	760 mm	200	0,068
226406	900 mm	48	0,075

Pílka Shark, prerezavacia

- reže oboma smermi
- nepotrebuje ostrenie



Drevená rukoväť

kalené zuby UltraSharp

kód	popis		
226410	330 mm	12	0,300

Pílka Shark, prerezavacia

- reže oboma smermi
- nepotrebuje ostrenie



Drevená rukoväť

kalené zuby UltraSharp

kód	popis		
226414	350 mm	10	0,300

Pílka Barracuda

- reže oboma smermi
- nepotrebuje ostrenie



drevená rukoväť

kalené zuby UltraSharp

kód	popis		
226397	350 mm	10	0,375
226399	400 mm	10	0,417
226398	500 mm	10	0,500

Pílka Barracuda

- reže oboma smermi
- nepotrebuje ostrenie



drevená rukoväť

kalené zuby UltraSharp

kód	popis		
226394	350 mm	1	0,560
226395	400 mm	6	0,610
226396	500 mm	6	0,583

Pílka chvostovka

- o 50% rýchlejší rez ako bežné píly

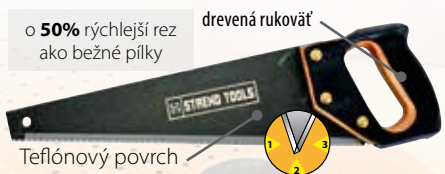

drevená rukoväť

Teflónový povrch

kód	popis		
226379	400 mm	6	0,270
226437	450 mm	1	0,500
226494	500 mm	1	

Pílka Barracuda

- reže oboma smermi
- nepotrebuje ostrenie



kalené zuby UltraSharp

kód	popis		
226400	350 mm	10	0,292
226401	400 mm	10	0,400
226402	500 mm	10	0,354

Pílka s púzdom

púzdro na pítku



kalené zuby UltraSharp

kód	popis		
226378	450 mm	24	0,630

Pílka prerezavacia, drevená rúčka



kód	popis		
226017	300 mm	10	0,370
226018	400 mm	10	0,400
226177	500 mm	10	0,430

Pílka čapovka



kód	popis		
226094	300 mm, drevená rúčka	10	0,510

Pílka čapovka



kód	popis		
226126	300 mm, plastová rúčka	10	0,460

Pílka záhradná na násadu



kód	popis		
226383	350 mm	5	0,630

Pílka záhradná

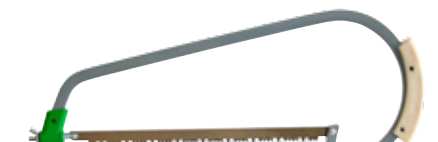

kód	popis		
226382	350 mm	5	0,600

Pílka záhradná

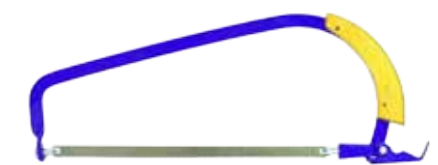

kód	popis		
226208	300 mm	1	0,540

Pílka prerezavacia 5in1



kód	popis		
226286	5 listov	10	1,000

Pílka oblúčková s držadlom



o 50% rýchlejší rez ako bežné píly

- reže oboma smermi
- nepotrebuje ostrenie



kód	popis		
226003	530 mm	12	0,765
226015	610 mm	12	0,840
226206	760 mm	12	0,935
226176	914 mm	12	1,080

Oblúčkový rám z oceľových trubiek vysokej kvality. Kalené zuby, ktoré vydržia 10x dlhšie. 3 uhly brúsenia zubov z oboch strán čo znižuje zahrievanie pílového listu, zvyšuje rýchlosť rezania a znižuje trenie

Pílka oblúčková s držadlom



o 50% rýchlejší rez ako bežné píly

- reže oboma smermi
- nepotrebuje ostrenie



kód	popis		
226372	760 mm	1	0,760

Oblúčkový rám z oceľových trubiek vysokej kvality. Kalené zuby, ktoré vydržia 10x dlhšie. 3 uhly brúsenia zubov z oboch strán čo znižuje zahrievanie pílového listu, zvyšuje rýchlosť rezania a znižuje trenie

Pílka záhradná, oblúčková



o 50% rýchlejší rez ako bežné píly

- reže oboma smermi
- nepotrebuje ostrenie



kód	popis		
226428	460 mm	12	0,583
226429	530 mm	12	0,625
226430	610 mm	12	0,660
226431	760 mm	12	0,750
226432	915 mm	12	0,833

Oblúčkový rám z oceľových trubiek vysokej kvality. Kalené zuby, ktoré vydržia 10x dlhšie. 3 uhly brúsenia zubov z oboch strán čo znižuje zahrievanie pílového listu, zvyšuje rýchlosť rezania a znižuje trenie

Pílka oblúčková s držadlom

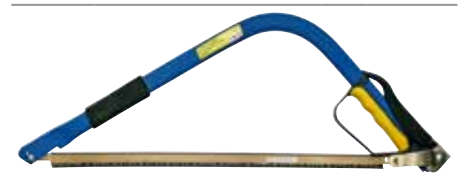

kód	popis		
226389	530 mm	12	0,710
226390	610 mm	12	0,330
226391	760 mm	1	0,620

Pílka záhradná, oblúčková



kód	popis		
226282	460 mm	25	0,520
226283	530 mm	25	0,560
226284	610 mm	25	0,600
226285	760 mm	25	0,760
226364	910 mm	25	0,840

Oblúčkový rám z oceľových trubiek vysokej kvality.

Pílka oblúčková, pílové listy



kód	popis		
226290	300 mm	12	0,540

Nožnice s pílkou

AQUACRAFT

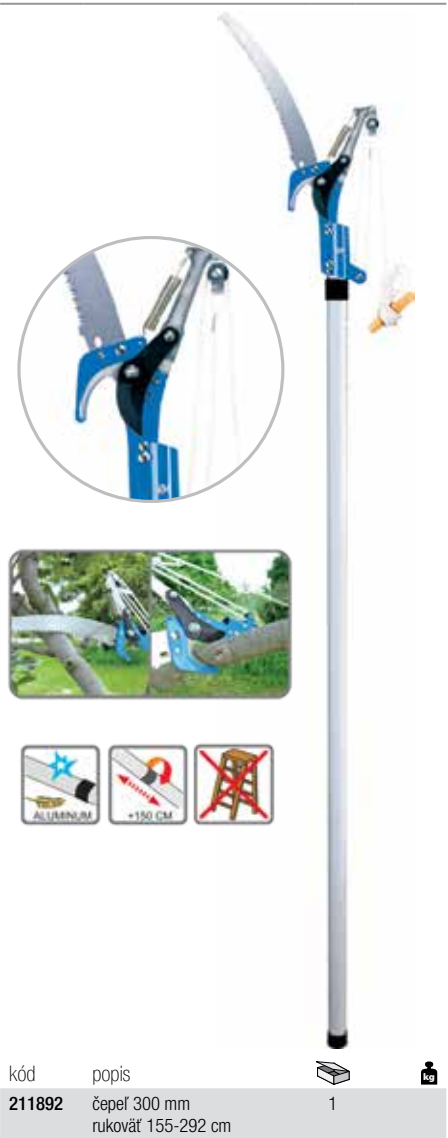

kód	popis		
211892	čepel 300 mm rukoväť 155-292 cm	1	

Nožnice na palicu s pílkou



kód	popis		
211757	bez násady	10	0,825

Nožnice na palicu s pílkou



kód	popis		
211224	s násadou, tyč 2800 mm	6	2,250

Nožnice na palicu s pílkou



kód	popis		
211257	s pílkou / 21-3/4"	1	0,600

Nožnice na palicu



kód	popis		
211256	15"	1	0,520

Pílka prerezavacia s palicou



kód	popis		
226550	s násadou 2,5 m	1	

Pílka teleskopická na konáre



kód	popis		
211396	1500 mm	1	1,680
211323	2500 mm	1	2,630

Kliešte vrúbľovacie



kód	popis		
211288	216 mm	1	

Vrúbľovacie kliešte sú vhodné pre vrúbľovanie napr. vinnej révy alebo ovocných stromov. Kliešte používajú Omega metódu štiepenia, ktorá poskytuje úspešnosť cez 80%.

Nôž štepársky



kód	popis		
2110120	rovný	10	0,105

Nôž štepársky



kód	popis		
2110119	krivý	10	0,105

Nôž štepársky



kód	popis		
2110121	oblý	20	0,105

Nôž štepársky



kód	popis		
2110122	krátky	1	0,105

Nôž ručný, obojstranný



kód	popis		
236175	225 mm	1	
236172	250 mm	1	
236173	300 mm	1	

Sekera pokrývačská



kód	popis		
236204	680 g, 400 mm, 3v1, monolit	6	1,000

Sekera viacúčelová



kód	popis		
236211	600 g, 34 cm, mäkká rúčka SOFT	1	

Sekera tesárska



kód	popis		
236111	700 g, 420 mm	24	0,700

Sekera tesárska



kód	popis		
236128	900 g, 380 mm	24	1,218

Sekera tesárska



kód	popis		
236087	800 g, 370 mm	24	0,980

Sekera mAXE bez násady



kód	popis		
236185	0600 g	30	0,600
236186	0800 g	1	0,800
236187	1000 g	1	1,000
236188	1250 g	20	1,250
236189	1500 g	16	1,550
236190	1800 g	1	1,800

Klin štiepací



kód	popis		
212815	976 g	1	1,600

Klin štiepací



kód	popis		
212795	2,5 kg	1	2,505

Klin plastový



kód	popis		
212644	200 mm	1	0,229
212804	250 mm	1	0,312
212798	500 mm	1	0,427

Klin štiepací



kód	popis		
212820	1,5 kg	1	
212841	2,0 kg	1	
212844	2,5 kg	1	

Klin štiepací



kód	popis		
212010	1,5 kg	10	1,550
212011	2,0 kg	10	2,050
212012	2,5 kg	10	2,550
212650	3,0 kg	10	3,050

Sekera kaľačka bez násady



kód	popis		
236031	2700 g	10	2,700

Sekera kaľačka bez násady



kód	popis		
236060	2500 g	6	2,500
236085	3000 g	1	3,000

Sapina lesnícka



kód	popis		
211124	1100g / 80 cm	1	2,160

Sekera, sklolinát



MULTI-NECK

PROFI náradie

kód	popis		
236205	1250g / 700 mm	1	
236206	1500g / 900 mm	1	

Sekera, sklolinát



MULTI-NECK

PROFI náradie

kód	popis		
236207	2500g / 900 mm	1	
236208	3500g / 900 mm	1	

Sekera s Alu úderníkom



MULTI-NECK

PROFI náradie

kód	popis		
236209	2500g / 900 mm / sklolinát	1	
236165	3500g / 900 mm / sklolinát	1	

Sekera štiepacia, nylon



klinový tvar umožňuje lepšie štiepenie dreva

kód	popis		
236123	1 kg, 350 mm	12	1,625
236124	1 kg, 610 mm	12	1,667
236125	2 kg, 860 mm	6	3,167

Sekera, nylon



kód	popis		
236201	1600g / 700 mm	6	2,560
236202	2000g / 800 mm	6	3,410
236203	2200g / 900 mm	6	3,550

Sekera (kálačka), sklolinát



kód	popis		
236212	1700 g, sklolinát, 840 mm	1	3,600

Sekera štiepacia, sklolinát



kód	popis		
236213	1024 g, sklolinát, 840 mm	1	2,000

Sekera štiepacia, sklolinát





klinový tvar umožňuje lepšie štiepenie dreva

kód	popis		
236110	2200 g, klinová, 880 mm	6	3,000

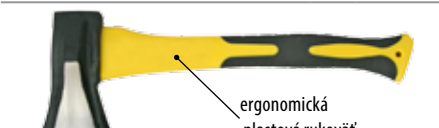
Sekera štiepacia, sklolinát



ergonomická plastová rukoväť

kód	popis		
236112	1,0 kg, 370 mm	12	1,583
236113	2,2 kg, 860 mm	6	3,417

Sekera, sklolinát



kód	popis		
236116	0600g, 360 mm	24	1,042
236117	0800g, 460 mm	24	1,167
236118	1000g, 610 mm	12	1,830
236160	1250g, 710 mm	12	2,330
236161	1500g, 800 mm	6	2,830
236162	1800g, 910 mm	6	3,000

Sekera, nylon



kód	popis		
236198	500g / 300 mm	6	0,729
236199	600g / 400 mm	6	1,104
236200	900g / 500 mm	6	1,500

Sekera, sklolinát



kód	popis		
236024	0600 g, 360 mm	24	1,000
236071	0800 g, 370 mm	24	1,125
236072	1000 g, 580 mm	12	1,833
236073	1250 g, 870 mm	12	2,170
236074	1500 g, 840 mm	6	3,060
236040	1800 g, 880 mm	6	3,000
236056	2000 g, 880 mm	6	3,000



Sekera (kálačka), sklolinát



kód	popis		
236075	2500 g, 900 mm	6	3,500
236076	3500 g, 900 mm	6	4,670

Sekera (kálačka), sklolinát



kód	popis		
236114	2500 g, s prelisom, 910 mm	6	4,000
236115	3500 g, s prelisom, 910 mm	6	4,830

Hickory WOOD

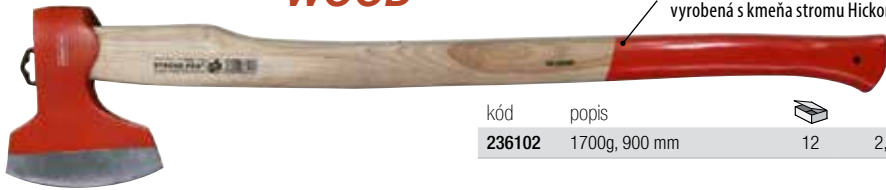

Sekera Hickory VikingAxe

ergonomická drevená rukoväť vyrobená s kmeňa stromu Hickory.

kód	popis		
236102	1700g, 900 mm	12	2,665

Hickory WOOD



Sekera Hickory JapanAxe

ergonomická drevená rukoväť vyrobená s kmeňa stromu Hickory.

klinový tvar umožňuje lepšie štiepenie dreva

kód	popis		
236101	2000g, štiepacia, 800 mm	6	2,660

Hickory WOOD



Sekera Hickory BLACK, kálačka

ergonomická drevená rukoväť vyrobená s kmeňa stromu Hickory.

kód	po pis		
236180	3 000g, 900 mm	1	3,680

Sekera klinová, sklolaminát



NOVINKA

kód	popis		
236215	3 000g	1	3,000

Sekera požiarnicka



kód	popis		
236084	1600g, 900 mm		

Sekera pre domácnosť



kód	popis		
236067	0600g, 360 mm	12	0,830
236065	0800g, 380 mm	12	1,040
236066	1000g, 430 mm	12	1,330
236002	1250g, 360 mm	12	1,830
236078	1400g, 900 mm	12	2,000
236109	1500g, 900 mm	12	2,170
236079	1600g, 900 mm	1	2,250
236038	1800g, 900 mm	12	2,500

Sekera SandBlaster



kód	popis		
2360023	1250g, 700 mm	6	2,000
2360024	1800g, 900 mm	6	2,660

Sekera kálačka SandBlaster



kód	popis		
2360021	2500g, 900 mm	6	3,670
2360022	3000g, 900 mm	6	4,170

Sekera Green



kód	popis		
236090	0600g, 360 mm	12	0,830
236091	0800g, 380 mm	12	1,040
236092	1000g, 430 mm	12	1,290
236093	1250g, 700 mm	12	1,920
236057	1400g, 700 mm	12	2,080
236094	1500g, 800 mm	12	2,170
236086	1600g, 900 mm	12	2,250
236095	1800g, 900 mm	12	2,540

Sekera Hickory BLACK • štiepacia

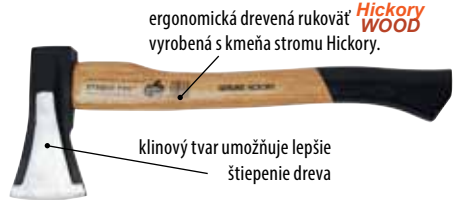

ergonomická drevená rukoväť vyrobená s kmeňa stromu Hickory.

klinový tvar umožňuje lepšie štiepenie dreva

kód	popis		
236181	1 000g, 430 mm	12	1,380
236182	2 000g, 800 mm	6	3,090
236183	3 000g, 800 mm	6	3,840

Sekera Hickory Axe

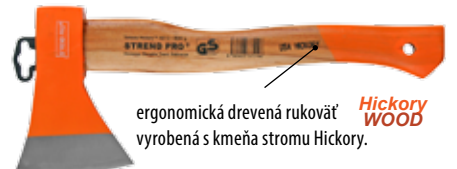

ergonomická drevená rukoväť vyrobená s kmeňa stromu Hickory.

kód	popis		
236103	0600g, 360 mm	24	0,830
236104	0800g, 380 mm	24	1,040
236105	1000g, 400 mm	24	1,330
236106	1250g, 700 mm	12	1,833
236107	1500g, 800 mm	12	2,160
236108	1800g, 800 mm	12	2,500

Sekera SandBlaster



kód	popis		
2360013	0600g, 360 mm	24	0,850
2360014	0800g, 380 mm	24	1,060
2360015	1000g, 400 mm	24	1,330
2360016	1250g, 700 mm	12	1,930
2360017	1400g, 700 mm	12	2,100
2360018	1500g, 800 mm	12	2,160
2360019	1600g, 800 mm	12	2,250
2360020	1800g, 900 mm	12	2,580

Sekera Economy



kód	popis		
236139	0600g, CNToon, 360 mm	25	0,760
236140	0800g, CNToon, 380 mm	12	1,000
236141	1000g, CNToon, 430 mm	25	1,280
236142	1250g, CNToon, 700 mm	12	1,583
236143	1400g, CNToon, 800 mm	12	1,917
236144	1500g, CNToon, 900 mm	12	2,083
236145	1600g, CNToon, 900 mm	12	2,167
236146	1800g, CNToon, 900 mm	12	2,583

Nožnice záhradné



kód	popis		
2110174	210 mm, Ø rezu 20 mm	10	0,316
2110136	Náhradná pružina	500	0,025

Nožnice záhradné



kód	popis		
2110175	200 mm, Ø rezu 20 mm	10	0,275
2110136	Náhradná pružina	500	0,025

Nožnice záhradné



kód	popis		
2110176	210 mm, Ø rezu 20 mm	6	0,300
2110136	Náhradná pružina	500	0,025

Nožnice záhradné



kód	popis		
2110177	210 mm, Ø rezu 20 mm	6	0,290
2110136	Náhradná pružina	500	0,025

Nožnice záhradné



kód	popis		
2110173	215 mm, Ø rezu 20 mm	6	0,342
2110136	Náhradná pružina	500	0,025

Nožnice na hrozno



kód	popis		
2110154	210 mm, Ø rezu 20 mm	10	0,270
2110134	Náhradná pružina	250	0,025

Nožnice na hrozno



kód	popis		
2110155	210 mm, ergonomická rúčka Ø rezu 18 mm	10	0,266

Nožnice na ovocie

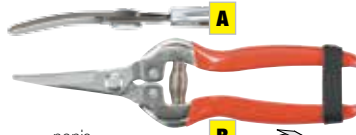

kód	popis		
2110222	A) 185 mm / zahnuté	10	0,155
2110223	B) 185 mm / rovné	10	0,155

Nožnice pre vinárov



kód	popis		
2110163	200mm, Ø rezu 20 mm	12	0,233

Nožnice na hrozno



kód	popis		
2110156	230 mm, Ø rezu 20 mm	10	0,300
2110133	Náhradná pružina	250	0,025

Nožnice záhradné

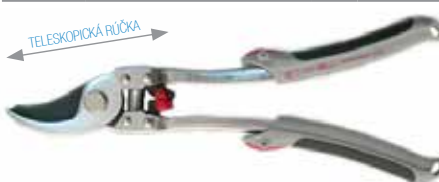

kód	popis		
211272	225-290 mm / výsuvné	6	0,375

Nožnice záhradné

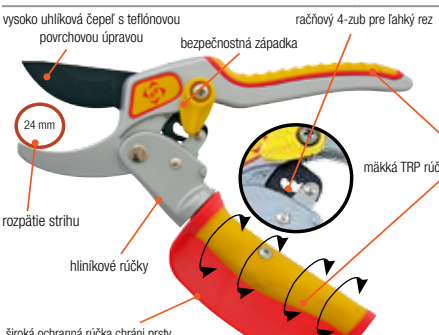

kód	popis		
2110092	205 mm, Ø rezu 24 mm	6	0,330

Nožnice na konáre



kód	popis		
2110185	kĺbové / 780 mm Ø rezu 45 mm	6	1,220

Nožnice záhradné



kód	popis		
2110246	210 mm, Ø rezu 16 mm	1	

Nožnice záhradné



kód	popis		
2110247	210 mm, Ø rezu 16 mm	1	

Nožnice záhradné



kód	popis		
2110138	200 mm, Ø rezu 20 mm	1	0,258

Nožnice záhradné



kód	popis		
2110137	200 mm, Ø rezu 20 mm	10	0,308

Nožnice záhradné



kód	popis		
211013	200 mm, Ø rezu 20 mm, kov, račňové	10	0,160

Nožnice záhradné



kód	popis		
2110167	210 mm, Ø rezu 20 mm	10	0,310
2110133	Náhradná pružina	250	0,025

Nožnice na živý plot



kód	popis		
211134	640 mm	1	

GARDEN

Nožnice na živý plot **STREND PRO[®]**



kód	popis		
2110250	550 mm	1	

Nožnice na živý plot **STREND PRO[®]**



kód	popis		
2110251	610 mm	1	

Nožnice na živý plot **STREND PRO[®]**



kód	popis		
2110216	580 mm	12	1,266

Nožnice na živý plot **STREND PRO[®]**



kód	popis		
2110215	650-860 mm, teleskopické	12	1,541

Nožnice na konáre **STREND PRO[®]**



kód	popis		
2110212	760 mm, Ø rezu 45 mm		

Nožnice na konáre **STREND PRO[®]**



kód	popis		
2110211	760 mm, nákovka, Ø rezu 45 mm	12	1,683

Nožnice na konáre **STREND PRO[®]**



kód	popis		
2110214	680-1010 mm, nákovka, Ø rezu 45 mm	12	1,766

Nožnice na konáre **STREND PRO[®]**



kód	popis		
2110248	690-1030 mm, Ø rezu 45 mm	1	

Nožnice na konáre **STREND PRO[®]**



kód	popis		
2110213	680-1010 mm, Ø rezu 45 mm	12	1,725

Nožnice na konáre **STREND PRO[®]**



kód	popis		
2110249	690-940 mm, Ø rezu 25 mm	1	

Nožnice na konáre **AQUACRAFT**

prenosová páka zvyšuje o 30% rezný výkon / extra ľahké umelohmotné rukoväte s protišmykovým povrchom pre ľahké a efektívne zaobchádzanie / dôkladne nabrúsené čepele s nepríľnavým povrchom pre výkonnejší rez



kód	popis		
211948	77x462 mm, Ø rezu 30 mm	12	

Nožnice na konáre **AQUACRAFT**

ozubený prevodník zvyšuje o 40% rezný výkon / dôkladne nabrúsené čepele s nepríľnavým povrchom pre výkonnejší rez / odolná rukoväť z trváceho a odľahčeného hliníka s hladkým povrchom



kód	popis		
211947	112x595 mm, Ø rezu 42 mm	12	

Nožnice záhradné **AQUACRAFT**

nenáročná na obsluhu a uzamykanie / ergonomická rukoväť pre pohodlnú prácu / nepríľnavé čepele / čepeľ s nákovkou na čerstvé drevo



kód	popis		
211623	57x132 mm, Ø rezu 18 mm	10	

Nožnice záhradné **AQUACRAFT**

nenáročná na obsluhu a uzamykanie / ergonomická rukoväť pre pohodlnú prácu / nepríľnavé čepele / čepeľ s nákovkou pre tvrdé a suché drevo



kód	popis		
211624	57x132 mm, Ø rezu 18 mm	10	

Nožnice záhradné **AQUACRAFT**

nastaviteľná veľkosť roztvorenia rukoväte / ergonomická rukoväť pre pohodlnú prácu / nepríľnavé čepele / čepeľ s nákovkou pre tvrdé a suché drevo



kód	popis		
211946	57x132 mm, Ø rezu 15 mm	10	

Nožnice záhradné **AQUACRAFT**

pre rezanie hustých vetiev / ochranný oblúk v spodnej rukoväti chráni prsty pred zranením / nepríľnavé čepele



kód	popis		
211945	67x126 mm, račňové, Ø rezu 20 mm	6	

Nožnice s rohatkou **AQUACRAFT**



kód	popis		
211557	70x140 mm, Ø rezu 18 mm	1	

Nelepiavá úprava hornej čepele. Palcom ovládaná bezpečnostná západka. Hliníkové nožnice. Ľahké a robustné pre komfortné rezanie. Energju šetriaci račňový efekt.

Nožnice záhradné **AQUACRAFT**



kód	popis		
211625	65x145 mm, Ø rezu 18 mm	1	

Odolné hliníkové držadlá s pohodlným mäkkým uchopením. Jednoduchý prístup a ovládanie zámku. Čepeľ s nákovkou pre tvrdé a suché drevo.

Nožnice na krovie, teleskopické



kód	popis		
211756	85x565/595 mm, Ø rezu 35 mm	1	

Čepele s neprílnavým povrchom. Jednoduchá starostlivosť a údržba. Protišmykové rukoväte pre bezpečné a ľahké používanie. Hliníkové teleskopické rukoväte pre lepší dosah (+ 30 cm).

Nožnice na konáre, teleskopické



kód	popis		
211657	105x575/605 mm, s nákovkou, Ø rezu 40 mm	1	

Čepele s neprílnavým povrchom. Jednoduchá starostlivosť a údržba. Prenosová páka pre ušetrenie energie. Hliníkové teleskopické rukoväte pre lepší dosah (+ 30 cm). Protišmykové rukoväte pre bezpečné a ľahké používanie.

Nožnice na konáre, teleskopické



kód	popis		
211594	105x605/635 mm, Ø rezu 40 mm	1	

Čepele s neprílnavým povrchom. Jednoduchá starostlivosť a údržba. Prenosová páka pre ušetrenie energie. Hliníkové teleskopické rukoväte pre lepší dosah (+ 30 cm). Protišmykové rukoväte pre bezpečné a ľahké používanie.

Nožnice na konáre, teleskopické



kód	popis		
211569	105x605/635 mm, s nákovkou, Ø rezu 40 mm	1	

Čepele s neprílnavým povrchom. Jednoduchá starostlivosť a údržba. Prenosová páka pre ušetrenie energie. Hliníkové teleskopické rukoväte pre lepší dosah (+ 30 cm). Protišmykové rukoväte pre bezpečné a ľahké používanie.

Nožnice na krovie, teleskopické



kód	popis		
211728	120x550/580 mm, Ø rezu 40 mm	1	

Čepele s neprílnavým povrchom. Jednoduchá starostlivosť a údržba. Prenosová páka pre ušetrenie energie. Hliníkové teleskopické rukoväte pre lepší dosah (+ 30 cm). Protišmykové rukoväte pre bezpečné a ľahké používanie.

Nožnice na konáre, teleskopické



kód	popis		
211603	105x575/605 mm, Ø rezu 40 mm	1	

Čepele s neprílnavým povrchom. Jednoduchá starostlivosť a údržba. Prenosová páka pre ušetrenie energie. Hliníkové teleskopické rukoväte pre lepší dosah (+ 30 cm). Protišmykové rukoväte pre bezpečné a ľahké používanie.

Nožnice na živý plot

extra ľahké umelohmotné rukoväte s protišmykovým povrchom pre ľahké a efektívne zaobchádzanie / prenosová páka zvyšuje o 30% rezný výkon / dôkladne nabrúsené čepele s neprílnavým povrchom pre výkonnejší rez



kód	popis		
211949	180x445 mm, Ø rezu 42 mm	12	

Nožnice na živý plot, teleskopické



kód	popis		
211501	210x440/460 mm	1	

Čepele s neprílnavým povrchom. Jednoduchá starostlivosť a údržba. Nastaviteľné rozpätie čepeľí. Hliníkové teleskopické rukoväte pre lepší dosah (+ 20 cm). Protišmykové rukoväte pre bezpečné a ľahké používanie.

Nožnice na živý plot, teleskopické



kód	popis		
211567	210x430/450 mm	1	

Čepele s neprílnavým povrchom. Jednoduchá starostlivosť a údržba. Nastaviteľné rozpätie čepeľí. Hliníkové teleskopické rukoväte pre lepší dosah (+ 20 cm). Protišmykové rukoväte pre bezpečné a ľahké používanie.

Kované nožnice na živý plot



kód	popis		
211589	225x395 mm	1	

Dlhé, robustné čepele pre obzvlášť plynulý a účinný strih. Protišmykové rukoväte pre bezpečné a ľahké používanie. Tlmenie nárazov.

GARDEN



Nožnice pre vinárov



kód	popis		
211578	220 mm, Ø rezu 20 mm	6	0,475

Nožnice záhradné



kód	popis		
211033	210 mm, Ø rezu 20 mm	10	0,250
2110141	Náhradná pružina	250	0,025

Nožnice záhradné



kód	popis		
211034	210 mm, Ø rezu 20 mm	10	0,220

Nožnice záhradné



kód	popis		
211655	200 mm, Ø rezu 20 mm	1	0,333
211790	225 mm, Ø rezu 20 mm	10	0,386
2110127	Náhradná pružina	1	0,020

Nožnice záhradné



kód	popis		
2110171	200 mm / nerez	12	0,340

Nožnice záhradné



kód	popis		
2110208	200 mm, Ø rezu 18 mm	12	0,238

Nožnice záhradné



kód	popis		
211812	200 mm / s koženým púzdom	1	0,437
2110199	200 mm / kované / bez púzdra	10	0,340
2110162	230 mm / bez púzdra	12	0,410

Nožnice na hrozno



kód	popis		
211507	225 mm, Ø rezu 22.5 mm	12	0,500

Nožnice na hrozno



kód	popis		
211508	210 mm, Ø rezu 25 mm	12	0,350

Nožnice na hrozno



kód	popis		
211506	235 mm, Ø rezu 24 mm	1	0,417

Nožnice na hrozno



kód	popis		
211511	200 mm, Ø rezu 20 mm	6	0,308

Nožnice záhradné



kód	popis		
2110105	210mm, Ø rezu 20 mm	10	0,175
2110139	Náhradná pružina	250	0,025

Nožnice záhradné



kód	popis		
211811	s plateným púzdom / 200 mm	1	0,330
211813	púzdro na nožnice / 100% nylon	1	0,036

Nožnice na hrozno



kód	popis		
2110044	200 mm, Ø rezu 18 mm	1	0,340

Nožnice záhradné



kód	popis		
2110170	180 mm	10	0,300

Nožnice záhradné



kód	popis		
2110006	200 mm, na suché konáre	10	0,280

Nožnice záhradné



kód	popis		
211394	230 mm	1	0,250

Nožnice záhradné



kód	popis		
211658	200 mm	1	0,260

Nožnice záhradné



kód	popis		
211080	200 mm	6	0,330
211810	230 mm	6	0,383
211816	250 mm	6	0,350
2110126	Náhradná pružina	1	0,020

Nožnice záhradné



kód	popis		
211817	200 mm	6	0,330

Nožnice záhradné



kód	popis		
211818	200 mm, Japan steel	6	0,330

Nožnice záhradné, mini



kód	popis		
211819	150 mm, Ø rezu 13 mm	6	0,200

Nožnice záhradné, mini



kód	popis		
211821	150 mm, Ø rezu 13 mm	6	0,200

Nožnice záhradné

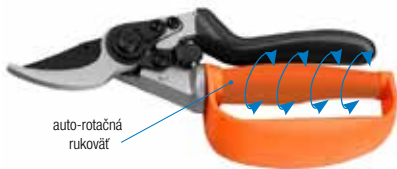

kód	popis		
2110253	200 mm, Ø rezu 25 mm	1	

Nožnice záhradné



kód	popis		
2110115	210 mm, otočné, Ø rezu 26 mm	12	0,375

Nožnice záhradné



kód	popis		
2110172	230 mm, Ø rezu 25 mm	10	0,544
2110125	Náhradná pružina	1	0,020

Nožnice záhradné



kód	popis		
211752	225 mm, Ø rezu 20 mm	12	0,438
2110140	Náhradná pružina	250	0,025

Nožnice záhradné

ROSTEX



kód	popis		
211468	183 mm, Ø rezu 12 mm	1	

Nožnice na zber ovocia



kód	popis		
2110239	200 mm, Ø rezu 30 mm	1	0,330

Nožnice záhradné



kód	popis		
2110252	210 mm, Ø rezu 20 mm	1	

Nožnice záhradné



kód	popis		
211703	215 mm, Ø rezu 20 mm	1	0,250

Nožnice záhradné



kód	popis		
211803	203 mm, Ø rezu 10 mm	1	0,258

Nožnice záhradné



kód	popis		
2110234	200 mm, Cr/Zn, Ø rezu 20 mm	1	0,250

Oberač ovocia

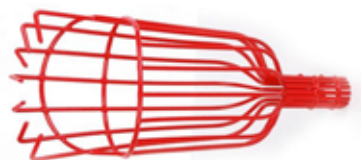

kód	popis		
211846	150 mm	1	0,500

Oberač ovocia

AQUACRAFT



kód	popis		
211930	teleskopický 150-300 cm, 180°	1	

- otočný kĺb umožňuje nastavenie pracovného uhla
- silná plastová konštrukcia
- nastaviteľná rukoväť vyrobená z trvácneho a odľahčeného hliníka, maximálne do 300 cm
- ostrý oceľový nôž pre odrezanie stopky

Oberač ovocia, teleskopický

kód	popis		
211473	155 mm; 2,4m	25	0,640

Brusič čepeľí

AQUACRAFT



kód	popis		
211681	multifunkčný	10	0,089

- na ostrenie nožov, nožnic na konáre, a záhradníckych nožnic
- funkcia ochrany čepeľí pred hrdzavením
- ochranný plášť na ochranu prstov pri práci

Brusič univerzálny

STREND PRO PREMIUM



kód	popis		
2110178	6 v1, univerzálny	10	0,120

Brusič čepeľí

STREND PRO PREMIUM



kód	popis		
2110123	120 mm	20	0,065

Oberač na ovocie



kód	popis		
211419	125 mm	50	0,180

Nožnice na krovie



kód	popis		
211794	650 mm / teleskopické	1	1,542

Nožnice na krovie



kód	popis		
211795	660 mm, Ø rezu 45 mm	1	1,833

Nožnice na krovie



kód	popis		
211799	680 mm, Ø rezu 38 mm	1	1,567

Nožnice na krovie



kód	popis		
211802	700 mm, Ø rezu 35 mm	1	1,292

Nožnice na konáre



kód	popis		
2110160	770-990 mm, Ø rezu 32 mm	6	1,416

Nožnice na konáre s nákovkou



kód	popis		
2110159	750-970 mm, Ø rezu 32 mm	6	1,416

Nožnice na konáre



kód	popis		
2110129	646-986 mm, Ø rezu 45 mm	6	2,000

Nožnice na konáre



kód	popis		
2110130	646-980 mm, Ø rezu 32 mm	6	1,916

Nožnice na krovie



kód	popis		
2110132	668-1000 mm, Ø rezu 38 mm	6	2,250

Nožnice na krovie



kód	popis		
2110131	636-970 mm, Ø rezu 28 mm	6	2,083

Nožnice na konáre



kód	popis		
2110128	680-1015 mm, Ø rezu 32 mm	6	1,750

Nožnice na krovie



kód	popis		
211798	660-1000 mm, Ø rezu 48 mm	1	1,701

Nožnice na krovie



kód	popis		
211796	610 mm, Ø rezu 38 mm	1	1,417

Nožnice na krovie



kód	popis		
211797	620 mm, Ø rezu 38 mm	1	1,375

Sada nožníc



kód	popis		
2110165	3 dielna	1	2,830

Kliešte viazacie



kód	popis		
2170768	na viazanie výhonkov so zásobníkom spony LIG150	1	

Spony do viazacích klieští



kód	popis		
2170769	spona LIG150, pozinkovaná	4200	

Kliešte viazacie

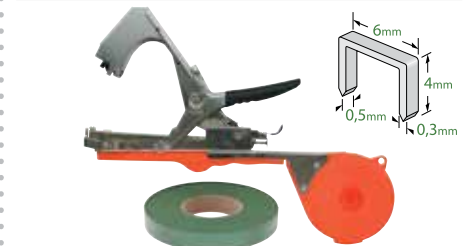

kód	popis		
229818	150x63 mm max. Ø 45 mm x Ø 20 mm	1	0,500

Kliešte sa používajú na viazanie výhonkov

217893	páska 2 mm x 11 mm x 26 m	1	
2170325	spony 10 000 ks	1	
2110281	sada náhradných dielov	1	

Nožnice na živý plot

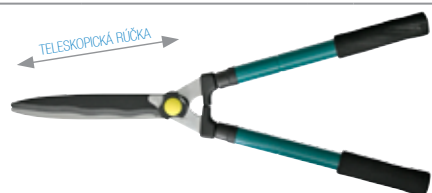

kód	popis		
2110161	660-838 mm	6	1,666

Nožnice na živý plot



kód	popis		
2110017	533 mm	6	1,330

Nožnice na živý plot, Alu



kód	popis		
2110014	710-920 mm, teleskopická	6	1,333

Nožnice na živý plot



kód	popis		
2110109	533 mm / hliníková rúčka	6	1,333

Nožnice na konáre



kód	popis		
211599	45 mm / teflon	1	0,291



Nožnice záhradné na trávnik

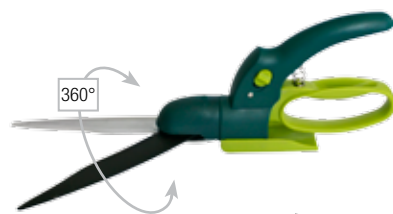

kód	popis		
2110151	otočné o 360°	10	0,716

Nožnice záhradné na trávnik



kód	popis		
2110040	Softface, otočné o 360°	1	0,340

Nožnice záhradné na trávnik

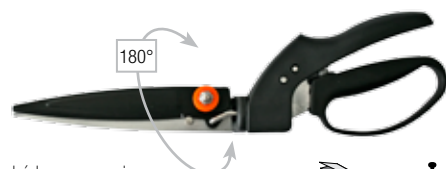

kód	popis		
2110150	otočné o 180°	10	0,466

Nožnice na konáre, teleskopické



kód	popis		
2110035	650 mm / kačkerky	1	1,500

Nožnice na konáre



kód	popis		
211943	65x1600 mm	12	

- výborná dostupnosť do korún stromov a hustého krovia
- strihanie nad hlavou bez rebríka alebo na úrovni zeme bez nutnosti sa zohnúť či kláknúť si
- ergonomicky tvarovaná rukoväť s mäkkým uchopením
- možnosť otáčania rezacej hlavy na získanie presne požadovanej polohy
- dôkladne nabrúsené čepele s neprínavým povrchom pre výkonnejší rez

Nožnice na trávnik

AQUACRAFT

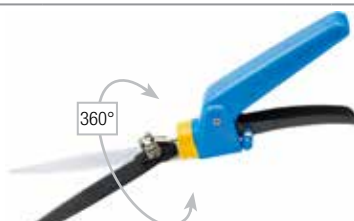

kód	popis		
211377	čepeľ 165 mm / rukoväť 19,5 mm	10	

Nožnice na trávnik

AQUACRAFT



kód	popis		
211650	čepeľ 175 mm / rukoväť 205 mm	12	

Nožnice na trávnik

AQUACRAFT



kód	popis		
211586	čepeľ 194 mm / rukoväť 860 mm	12	

Kvetináč Toscana



kód	popis		
255018	A) 13x12,5cm / 1,7lit. / fialový	1	
255036	A) 13x12,5cm / 1,7lit. / olivový	1	
255019	A) 15x14,5cm / 2,5lit. / fialový	1	
255037	A) 15x14,5cm / 2,5lit. / olivový	1	
255038	A) 17x16,5cm / 3,7lit. / olivový	1	
255197	A) 17x16,5cm / 3,7lit. / fialový	1	
255198	A) 19x18,5cm / 5,0lit. / fialový	1	
255039	A) 19x18,5cm / 5,0lit. / olivový	1	
255041	B) 13x12,5cm / 1,6lit. / oranžový	1	
255074	B) 13x12,5cm / 1,6lit. / biely	1	
255042	B) 15x14,5cm / 2,2lit. / oranžový	1	
255079	B) 17x16,5cm / 3,0lit. / oranžový	1	
255016	B) 17x16,5cm / 3,0lit. / biely	1	
255075	B) 19x18,5cm / 4,4lit. / oranžový	1	
255080	B) 19x18,5cm / 4,4lit. / biely	1	

Kvetináč Orchid



kód	popis		
255243	A) 13 / Cafe Latte	1	
255242	A) 13 / oranžový	1	
255241	A) 13 / svetlozelený	1	
255244	B) 13 / Cafe Latte	1	
255246	B) 13 / oranžový	1	
255245	B) 13 / svetlozelený	1	

Kvetináč Koral a Grace



kód	popis		
255199	A) 13 / fialový	1	
255203	A) 13 / tehlový	1	
255200	A) 15 / fialový	1	
255204	A) 15 / tehlový	1	
255201	A) 17 / fialový	1	
255205	A) 17 / tehlový	1	
255202	A) 19 / fialový	1	
255206	A) 19 / tehlový	1	
255264	B) 19 / tehlový	1	
255265	B) 23 / tehlový	1	
255266	B) 29 / tehlový	1	
255267	B) 34 / tehlový	1	
255268	B) 40 / tehlový	1	

Kvetináč Lotos



kód	popis		
255232	30 / pistáciový	1	
255234	30 / fialový	1	
255233	40 / pistáciový	1	
255235	40 / fialový	1	

Kvetináč Capri a Omega



kód	popis		
255221	A) 12 / tehlový	1	
255226	A) 12 / biely	1	
255222	A) 15 / tehlový	1	
255227	A) 15 / biely	1	
255223	A) 18 / tehlový	1	
255228	A) 18 / biely	1	
255224	A) 22 / tehlový	1	
255229	A) 22 / biely	1	
255225	A) 28 / tehlový	1	
255230	A) 28 / biely	1	
255247	B) 11 / tehlový	1	
255254	B) 13 / biely	1	
255248	B) 13 / tehlový	1	
255255	B) 15 / biely	1	
255249	B) 15 / tehlový	1	
255256	B) 17 / biely	1	
255250	B) 17 / tehlový	1	
255257	B) 19 / biely	1	
255251	B) 19 / tehlový	1	
255258	B) 25 / biely	1	
255252	B) 25 / tehlový	1	

Kvetináč



kód	popis		
255295	A) 70x70x80 mm	1	
255294	A) 90x90x100 mm	1	
255304	B) 100 mm	1	
255303	B) 110 mm	1	
255302	B) 120 mm	1	
255301	B) 130 mm	1	
255300	B) 140 mm	1	
255299	B) 150 mm	1	
255298	B) 160 mm	1	
255297	B) 170 mm	1	
255296	B) 180 mm	1	

Kvetináč ICS PANDORA



kód	popis		
255138	15x13 cm, fialový	1	0,100
255137	15x13 cm, oranžový	1	0,100
255139	15x13 cm, zelený	1	0,100
255141	18x15 cm, fialový	1	0,100
255140	18x15 cm, oranžový	1	0,100
255142	18x15 cm, zelený	1	0,100
255112	18x18 cm, biely	1	0,222
255113	18x18 cm, červený	1	0,222
255143	21x19 cm, oranžový	1	0,100
255145	21x19 cm, zelený	1	0,100
255114	21x21 cm, červený	1	0,325
255115	21x21 cm, zelený	1	0,325
255150	24x12x11 cm, fialový	1	0,100
255149	24x12x11 cm, oranžový	1	0,100
255152	24x12x11 cm, šedý	1	0,100
255151	24x12x11 cm, zelený	1	0,100
255147	24x21 cm, fialový	1	0,100
255146	24x21 cm, oranžový	1	0,100
255148	24x21 cm, zelený	1	0,100
255117	24x24 cm, červený	1	0,454
255116	24x24 cm, šedý	1	0,454

Podložka Afro, Gala a Coubi

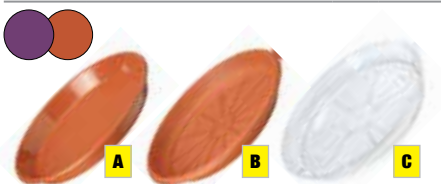

kód	popis		
255215	A) 20 / tehlová	1	
255216	A) 22 / tehlová	1	
255217	A) 24 / tehlová	1	
255218	A) 26 / tehlová	1	
255219	A) 28 / tehlová	1	
255220	A) 32 / tehlová	1	
255007	B) 14 / fialová	1	
255208	B) 14 / tehlová	1	
255008	B) 16 / fialová	1	
255010	B) 16 / tehlová	1	
255009	B) 18 / fialová	1	
255207	B) 20 / fialová	1	
255011	B) 20 / tehlová	1	
255275	C) 120 mm / priesvitná	1	
255276	C) 140 mm / priesvitná	1	
255277	C) 175 mm / priesvitná	1	
255278	C) 210 mm / priesvitná	1	
255279	C) 260 mm / priesvitná	1	
255280	C) 320 mm / priesvitná	1	
255281	C) 360 mm / priesvitná	1	
255282	C) 460 mm / priesvitná	1	

FLOWER POTS

Kvetináč Afro a Flora s podložkou



kód	popis		
255209	A) 25 / tehlový	1	
255210	A) 28 / tehlový	1	
255211	A) 31 / tehlový	1	
255212	A) 35 / tehlový	1	
255213	A) 40 / tehlový	1	
255214	A) 45 / tehlový	1	
255236	B) 15 / tehlový	1	
255237	B) 17 / tehlový	1	
255238	B) 20 / tehlový	1	
255239	B) 22 / tehlový	1	
255240	B) 25 / tehlový	1	

Kvetináč Roma



kód	A	popis	B		
255259	A) 15 / tehlový		1		
255260	A) 20 / tehlový		1		
255261	A) 25 / tehlový		1		
255262	B) I 2+3 / tehlový		1		
255263	B) II 3+4 / tehlový		1		

Kvetináč Cube



kód	popis		
255004	392x160 mm, bez systému	1	
255434	587x236 mm, bez systému	1	
255270	392x160 mm, so systémom	1	
255271	587x236 mm, so systémom	1	

Kvetináč Balcony

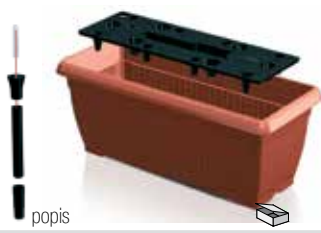

kód	popis		
255272	600x140 mm	1	
255274	500x160 mm	1	
255273	600x238 mm	1	

Kvetináč TERRA



kód	popis		
255155	150/130 mm, 01.7 lit.	1	0,070
255156	190/160 mm, 03.5 lit.	1	
255157	240/200 mm, 07.0 lit.	1	
255158	300/250 mm, 13.8 lit.	1	
255159	370/300 mm, 25.2 lit.	1	
255160	450/350 mm, 40.0 lit.	1	
255161	podložka / 140/19 mm	1	
255162	podložka / 170/24 mm	1	
255163	podložka / 220/30 mm	1	
255164	podložka / 270/38 mm	1	
255165	podložka / 340/45 mm	1	
255166	podložka / 410/55 mm	1	

Kvetináč ICS THEA



kód	popis		
255020	16x12 cm	1	0,073
252021	18x14 cm	1	
255024	20x15 cm	1	
255026	23x19 cm	1	
255031	26x21 cm	1	0,243
255029	30x25 cm	1	0,289
255043	25x29 cm	1	0,413
255025	40x32 cm	1	0,685
255033	45x35 cm	1	0,876
255035	55x37 cm	1	1,674
255027	65x47 cm	1	2,230

Kvetináč ICS CLIVIA



kód	popis		
255098	20x08 cm	1	0,062
255014	25x10 cm	1	0,109
255099	30x12 cm	1	0,160
255100	35x13 cm	1	0,232
255101	40x14 cm	1	0,279
255102	50x16 cm	1	0,525

Kvetináč ICS MELISA



kód	popis		
255105	40x20x16 cm	1	0,440
255106	50x20x16 cm	1	0,530
255107	60x20x16 cm	1	0,640

Kvetináč ICS MINIMELISSA



kód	popis		
255108	30x12x11 cm	1	0,160

Kvetináč ICS SERENELLA



kód	popis		
255103	25x10 cm	1	0,150
255104	30x12 cm	1	0,201
255305	35x12 cm	1	

Kvetináč ICS AGRO



kód	popis		
255127	400mm; 6,8 lit., Terakota	1	
255128	500mm; 8,5 lit., Terakota	1	
255129	600mm; 8,5 lit., Terakota	1	
255130	podložka / 400mm, Terakota	1	
255131	podložka / 500mm, Terakota	1	
255132	podložka / 600mm, Terakota	1	

Držiak



kód	popis		
255133	200/250mm, Terakota	1	

Podložka ICS MARGHERITA



kód	popis		
255109	25 cm	1	0,253
255110	35 cm	1	0,428
255111	45 cm	1	0,675

Podložka ICS ERICA



kód	popis		
255067	14 cm	1	0,016
255068	16 cm	1	0,026
255069	18 cm	1	0,031
255087	20 cm	1	0,042
255090	22 cm	1	0,057
255091	24 cm	1	0,062
255092	28 cm	1	0,078
255093	30 cm	1	0,093
255094	33 cm	1	0,109
255095	38 cm	1	0,160
255435	43 cm	1	
255096	46 cm	1	0,289
255097	55 cm	1	0,454
255436	65 cm	1	
255437	80 cm	1	

Kvetináč Ratolla round, ratan



kód	popis		
255383	Ø 190 mm, výška 165 mm, biely	10	
255384	Ø 190 mm, výška 165 mm, krémový	10	
255385	Ø 190 mm, výška 165 mm, tmavohnedý	10	
255386	Ø 250 mm, výška 219 mm, biely	5	
255387	Ø 250 mm, výška 219 mm, krémový	5	
255388	Ø 250 mm, výška 219 mm, tmavohnedý	5	



Kvetináč Rato round, ratan



kód	popis		
255393	Ø 200 mm, výška 224 mm, biely	5	
255394	Ø 200 mm, výška 224 mm, krémový	5	
255395	Ø 200 mm, výška 224 mm, tmavohnedý	5	
255396	Ø 300 mm, výška 324 mm, biely	5	
255397	Ø 300 mm, výška 324 mm, krémový	5	
255398	Ø 300 mm, výška 324 mm, tmavohnedý	5	

Kvetináč Rato tubus



kód	popis		
255311	Ø 250 mm, 9/15.5 lit., výška 476 mm, hnedý, ratan	5	
255312	Ø 250 mm, 9/15.5 lit., výška 476 mm, biely, ratan	5	
255313	Ø 250 mm, 9/15.5 lit., výška 476 mm, krémový, ratan	5	
255314	Ø 400 mm, 35/64 lit., výška 763 mm, hnedý, ratan	5	
255315	Ø 400 mm, 35/64 lit., výška 763 mm, biely, ratan	5	
255316	Ø 400 mm, 35/64 lit., výška 763 mm, krémový, ratan	5	

Kvetináč Ratolla P

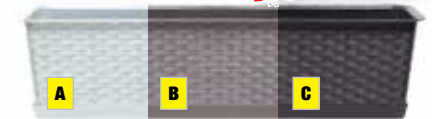

NOVINKA



kód	popis		
255448	A) 489x173x150 mm, biely	1	
255450	A) 685x173x150 mm, biely	1	
255449	B) 489x173x150 mm, mocca	1	
255451	B) 685x173x150 mm, mocca	1	
255447	C) 489x173x150 mm, tmavohnedý	1	
255452	C) 685x173x150 mm, tmavohnedý	1	



Kvetináč Rato low



kód	popis		
255321	d200 x š200 x v202 mm, 6.8 lit., hnedý, ratan	5	
255322	d200 x š200 x v202 mm, 6.8 lit., biely, ratan	5	
255323	d320 x š320 x v325 mm, 32 lit., hnedý, ratan	5	
255324	d320 x š320 x v325 mm, 32 lit., biely, ratan	5	
255325	d400 x š400 x v408 mm, 64 lit., hnedý, ratan	5	
255326	d400 x š400 x v408 mm, 64 lit., biely, ratan	5	

Kvetináč Ratolla square



kód	popis		
255307	Ø 190 mm, 3.8 lit., výška 159 mm, hnedý, ratan	10	
255308	Ø 190 mm, 3.8 lit., výška 159 mm, biely, ratan	10	
255389	Ø 190 mm, 3.8 lit., výška 159 mm, krémový, ratan	10	
255309	Ø 250 mm, 8.2 lit., výška 220 mm, hnedý, ratan	10	
255310	Ø 250 mm, 8.2 lit., výška 220 mm, biely, ratan	10	
255390	Ø 250 mm, 8.2 lit., výška 220 mm, krémový, ratan	10	



Kvetináč Rato square



kód	popis		
255327	d225 x š225 x v421 mm, 8/16.3 lit., čierny, ratan	5	
255329	d225 x š225 x v421 mm, 8/16.3 lit., biely, ratan	5	
255328	d225 x š225 x v421 mm, 8/16.3 lit., hnedý, ratan	5	
255330	d225 x š225 x v421 mm, 8/16.3 lit., krémový, ratan	5	
255331	d325 x š325 x v610 mm, 21/49 lit., čierny, ratan	5	
255333	d325 x š325 x v610 mm, 21/49 lit., biely, ratan	5	
255332	d325 x š325 x v610 mm, 21/49 lit., hnedý, ratan	5	
255334	d325 x š325 x v610 mm, 21/49 lit., krémový, ratan	5	

Systém zavlažovací



kód	popis		
255431	430x129x45 mm, hranatý		
255046	505x180x42 mm, hranatý		



Systém zavlažovací



kód	popis		
255399	210x50x210 mm, hranatý		
255439	240x50x240 mm, hranatý		
255400	295x55x295 mm, hranatý		
255401	360x65x360 mm, hranatý		

Systém zavlažovací



kód	popis		
255402	217x50x212 mm, okrúhly		
255403	340x59x340 mm, okrúhly		

Kvetináč Matuba slim



kód	popis		
255088	Ø 300 mm, výška 550 mm, biely	1	
255049	Ø 300 mm, výška 550 mm, krémový	1	
255089	Ø 300 mm, výška 550 mm, šedý	1	
255416	Ø 400 mm, výška 780 mm, biely	1	
255417	Ø 400 mm, výška 780 mm, krémový	1	
255418	Ø 400 mm, výška 780 mm, šedý	1	

Kvetináč Matuba



kód	popis		
255413	Ø 350 mm, výška 324 mm, biely	1	
255414	Ø 350 mm, výška 324 mm, krémový	1	
255415	Ø 350 mm, výška 324 mm, šedý	1	

Kvetináč Lace

NOVINKA

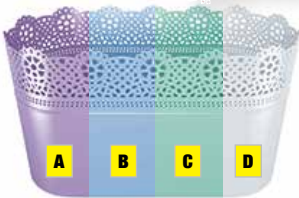

kód	popis		
255061	A) 285x135x155 mm, levanduľový	1	
255062	B) 285x135x155 mm, modrý	1	
255063	C) 285x135x155 mm, pistáciový	1	
255064	D) 285x135x155 mm, biely	1	

Kvetináč Naturo



kód	popis		
255372	Ø 145 mm, výška 148 mm, biely	1	
255373	Ø 145 mm, výška 148 mm, broskyňový	1	
255374	Ø 145 mm, výška 148 mm, krémový	1	
255375	Ø 145 mm, výška 148 mm, šedý	1	
255376	Ø 175 mm, výška 179 mm, biely	1	
255377	Ø 175 mm, výška 179 mm, broskyňový	1	
255378	Ø 175 mm, výška 179 mm, krémový	1	
255379	Ø 175 mm, výška 179 mm, šedý	1	

Kvetináč Naturo



kód	popis		
255380	275x148 mm, biely	1	
255381	275x148 mm, broskyňový	1	
255382	275x148 mm, krémový	1	

Kvetináč Lace



kód	popis		
255354	Ø 140 mm, biely	10	
255454	Ø 140 mm, modrý	10	
255426	Ø 140 mm, levandula	10	
255360	Ø 140 mm, krémový	10	
255425	Ø 140 mm, pistácia	10	
255355	Ø 160 mm, biely	10	
255455	Ø 160 mm, modrý	10	
255427	Ø 160 mm, levandula	10	
255361	Ø 160 mm, krémový	10	
255429	Ø 160 mm, pistácia	10	
255356	Ø 180 mm, biely	10	
255456	Ø 180 mm, modrý	10	
255428	Ø 180 mm, levandula	10	
255362	Ø 180 mm, krémový	10	
255430	Ø 180 mm, pistácia	10	

Kvetináč Splofy

NOVINKA



kód	popis		
255052	Ø 295 mm, výška 249 mm, biely	1	
255054	Ø 295 mm, výška 249 mm, mocca	1	
255053	Ø 295 mm, výška 249 mm, šalvia	1	

Kvetináč Rato Round WS

NOVINKA



kód	popis		
255065	Ø 256 mm, výška 219 mm, biely	1	
255066	Ø 256 mm, výška 219 mm, mocca	1	
255070	Ø 256 mm, výška 219 mm, tmavohnedý	1	

Kvetináč RatollaRound, s vešiakom



kód	popis		
255391	Ø 243 mm, výška 160 mm, biely	5	
255392	Ø 243 mm, výška 160 mm, krémový	5	
255441	Ø 243 mm, výška 160 mm, antracit	5	
255442	Ø 243 mm, výška 160 mm, hnedý	5	

Kvetináč Ratolla P



kód	popis		
255317	d386 x š154 x v142 mm, 6 lit., hnedý, ratan	10	
255318	d386 x š154 x v142 mm, 6 lit., biely, ratan	10	
255319	d492 x š172 x v174 mm, 12 lit., hnedý, ratan	10	
255320	d492 x š172 x v174 mm, 12 lit., biely, ratan	10	

Kvetináč Ratolla Railing oval



kód	popis		
255443	298x242x225 mm, biely	1	
255444	298x242x225 mm, mocca	1	
255445	298x242x225 mm, tmavohnedý	1	
255446	298x242x225 mm, antracit	1	

Kvetináč Sandy Slim



kód	popis		
255058	Ø 390 mm, výška 708 mm, biely	1	
255059	Ø 390 mm, výška 708 mm, mocca	1	
255060	Ø 390 mm, výška 708 mm, šedý	1	

Kvetináč Sand Slim



kód	popis		
255404	Ø 345 mm, výška 385 mm, biely	1	
255407	Ø 390 mm, výška 750 mm, biely	1	
255405	Ø 345 mm, výška 385 mm, krémový	1	
255408	Ø 390 mm, výška 750 mm, krémový	1	
255406	Ø 345 mm, výška 385 mm, šedý	1	
255409	Ø 390 mm, výška 750 mm, šedý	1	

Kvetináč Woode

NOVINKA



kód	popis		
255457	Ø 488 mm, výška 457 mm, 54 lit., biely	1	
255458	Ø 488 mm, výška 457 mm, 54 lit., hnedý	1	

Kvetináč Ratolla PW



kód	popis		
255453	492x172x174 mm, biely, ratan	1	
255433	492x172x174 mm, hnedý, ratan	1	

FLOWER POTS

Kvetináč Finezja DĽUTO



kód	popis		
255335	190x190x360 mm, biely	1	
255337	250x250x465 mm, biely	1	
255336	190x190x360 mm, krémový	1	
255338	250x250x465 mm, krémový	1	

Kvetináč Finezja



kód	popis		
255349	190x190x360 mm, šedý	1	
255345	190x190x360 mm, biely	1	
255346	190x190x360 mm, bordový	1	
255348	190x190x360 mm, krémový	1	
255347	190x190x360 mm, limetka	1	

Kvetináč Begonia DĽUTO



kód	popis		
255350	190x560x195 mm, krémový	1	
255351	190x560x195 mm, šedý	1	

Kvetináč Rocka



kód	popis		
255410	Ø 345 mm, výška 321 mm, biely	5	
255411	Ø 345 mm, výška 321 mm, krémový	5	
255412	Ø 345 mm, výška 321 mm, šedý	5	

Kvetináč Luna



kód	popis		
255421	350x50x50 mm, číry	10	
255419	350x50x50 mm, fialový	10	
255420	350x50x50 mm, zelený	10	

Kvetináč Finezja



kód	popis		
255424	125x125x200 mm, číry	10	
255422	125x125x200 mm, fialový	10	
255423	125x125x200 mm, zelený	10	

Kvetináč Juka DĽUTO



kód	popis		
255339	190x190x195 mm, biely	1	
255341	190x190x195 mm, krémový	1	
255340	190x190x195 mm, čierny	1	
255342	250x250x260 mm, biely	1	
255344	250x250x260 mm, krémový	1	
255343	250x250x260 mm, čierny	1	

Kvetináč COUBI, skladací



kód	popis		
255044	stolový bez retiazky, olivový	1	
255352	stolový bez retiazky, zelený	1	
255189	závesný s retiazkou, olivový	1	

295/380 mm

Kvetináč ICS DECORA



kód	popis		
255119	30x21 cm	1	0,330
255121	30x21 cm	1	0,330
255120	30x21 cm	1	0,330
255122	podložka Decora BC, 28x3,8cm	1	0,078
255123	podložka Decora BLU, 28x3,8cm	1	0,078
255124	podložka Decora GR, 28x3,8cm	1	0,078
255125	podložka Decora GL, 28x3,8cm	1	0,078

Kokosový kvetináč, závesný



kód	popis		
221839	250x250x120 mm	24	0,341
221841	300x300x140 mm	24	0,420
221837	350x350x170 mm	18	0,685

Kokosový kvetináč s konštrukciou



kód	popis		
255045	A) nástenný / 300x145x130 mm	20	0,325
255047	B) nástenný / 620x190x175 mm	12	1,080

Kokosový kvetináč s konštrukciou



kód	popis		
255048	nástenný / 610x170x180 mm	12	0,930

Kvetináč COUBI



kód	popis		
255190	jednoduchý, olivový	1	
255353	jednoduchý, zelený	1	



Tyč kokosová



kód	popis		
2110259	40x400 mm	1	
2110260	45x600 mm	1	
2110261	45x900 mm	1	
2110262	45x1200 mm	1	
2110263	45x1500 mm	1	
2110264	45x1800 mm	1	

Tyč prútená, špiralová



kód	popis		
2110265	060 cm	1	
2110266	090 cm	1	
2110267	120 cm	1	
2110268	150 cm	1	

Tyč na kvety



kód	popis		
2210641	500 mm / PE / 10ks.	100	0,130

Vešiak AKANT

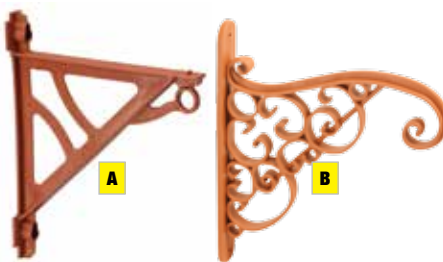

kód	popis		
255195	A) Akant / terakota	1	
255231	B) Hook / 19,5x23 cm / tehlový	1	

Páska na viazanie rastlín



kód	popis		
2110271	12 mm x 45 m	1	
2110272	12 mm x 60 m	1	

Viazač rastlín

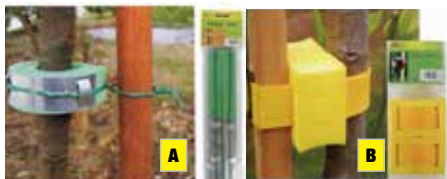

kód	popis		
2110274	A) 300 mm, bal. 2 ks	2	
2110273	B) 640 mm, bal. 2 ks	2	

Páska viazacia



kód	popis		
2170852	120 mm / 80ks	80	
2170157	170 mm / 80ks	80	
2170853	220 mm / 80ks	80	

Vešiak s retiazkou



kód	popis		
2170565	čierny, 24x22x12.5 cm	1	
2170710	biely, 24x22x12.5 cm	1	

Vešiak ICS TULIPANO



kód	popis		
255126	50 cm, bez kvetináča	1	0,029

Ochrana na stromčeky



kód	popis		
2110280	max. Ø 115 mm	1	
2110282	max. Ø 320 mm	1	

Zabraňuje zatrávňovaniu, zlepšuje estetiku záhrady

Ochrana na stromčeky

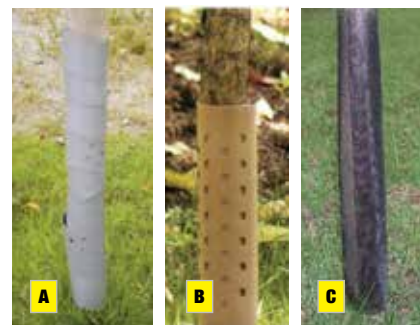

kód	popis		
2110279	A) 060 cm, bal. 3 ks, plastová	3	
2210278	A) 100 cm, bal. 3 ks, plastová	3	
2110275	B) 200x335 mm, plastová	1	
211907	C) 110 cm, sieť, PE	1	0,850

Reťaz zaistovacia



kód	popis		
432139	oko-1,25x0,5x0,24 cm / L-25m	1	5,500

Stojan na kvetináče



kód	popis		
221169	186x86 cm	1	

Tyč na paradajky

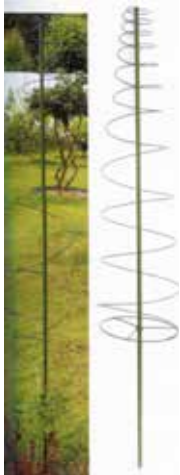

kód	popis		
2110269	165x30 cm + 3 spony	1	

Sada tyčí na paradajky



kód	popis		
211908	Ø1,1x150 cm / 3x tyč, 9x konektor	1	0,651

Tyč drôtená k paradajkám



kód	popis		
211038	Zn / 1,2 m / 5,5 mm	1	0,240
211155	Zn / 1,5 m / 6,0 mm	10	0,370
211313	Zn / 1,8 m / 6,5 mm	10	0,500
211780	PVC / 1,2 m / 5,5 mm	1	0,240
211782	PVC / 1,5 m / 6,0 mm	1	0,430
211781	PVC / 1,8 m / 6,5 mm	1	0,510

Tyč kovová do záhrady



kód	popis		
211909	0600x075x5,5 mm	1	0,160
211910	0600x150x5,5 mm	1	0,210
211911	0900x075x5,5 mm	1	0,220
211912	0900x150x5,5 mm	1	0,270
211913	0900x200x5,5 mm	1	0,300
211914	1200x075x5,5 mm	1	0,280
211915	1200x150x5,5 mm	1	0,320

Tyč Gardens do záhrady / PVC



kód	popis		
211778	0600/08 mm	100	0,035
211779	0750/08 mm	100	0,044
211783	0900/08 mm	100	0,052
211787	1200/08 mm	100	0,070
211777	1500/08 mm	100	0,156
211776	1800/08 mm	100	0,105
211775	0750/11 mm	100	0,054
211774	0900/11 mm	100	0,065
211765	1200/11 mm	100	0,087
211784	1500/11 mm	100	0,106
211789	1800/11 mm	100	0,128
211804	2100/11 mm	100	0,149
211882	0900/16 mm	50	0,113
211883	1200/16 mm	50	0,150
211884	1500/16 mm	50	0,188
211885	1800/16 mm	50	0,226
211886	2100/16 mm	50	0,266
211887	0900/20 mm	50	0,158
211888	1200/20 mm	50	0,210
211769	1500/20 mm	50	0,263
211770	1800/20 mm	50	0,315
211771	2100/20 mm	50	0,368

Spojka plastová na tyč Gardens



kód	popis		
211889	08 mm	30	0,082
211890	11 mm	24	0,091
211891	16 mm	12	0,091

Tyč do záhrady, sklolaminát



kód	popis		
211697	100 cm / 7,0 mm	1	
211612	120 cm / 7,0 mm	1	
211667	150 cm / 7,9 mm	1	0,038
211668	180 cm / 7,9 mm	1	0,023
211669	210 cm / 9,5 mm	1	0,050

Tyč COUBI na orchideje

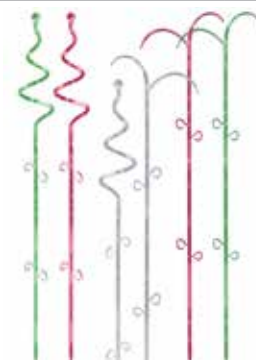

kód	popis		
2210590	na orchideu / 30ks.	30	0,100

Držiak na kvety, ABS



kód	popis		
211916	460x285 mm / 2ks	2	0,158
211917	295x180 mm / 2ks	2	0,158

Držiak na kvety, plastový



kód	popis		
211897	60 cm / 3x krúžky Ø22,20,18 cm	1	0,158
211898	75 cm / 3x krúžky Ø28,25,22 cm	1	0,188
211899	90 cm / 4x krúžky Ø30,28,26,22 cm	1	0,219

Stojan oblúkový na rastliny

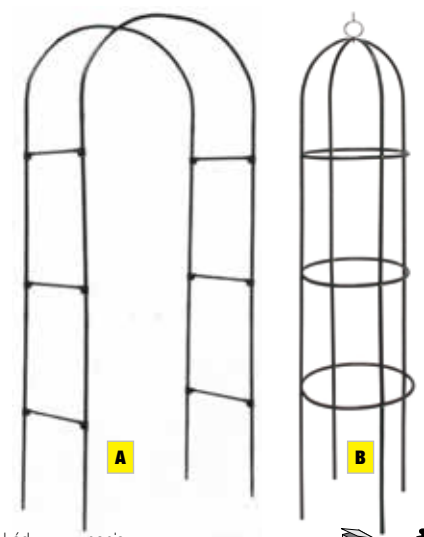

kód	popis		
221149	A) 190x38 cm, kovový	1	
2212055	A) 240x37 cm, kovový	1	
2212056	B) 188x40 cm, kovový	1	

PARENISKA A SADBOVAČE

Parenisko



kód	popis		
2170851	70x50x95 cm / 2x polička	1	

materiál: fólia + kov

Parenisko



kód	popis		
2170850	70x50x128 cm / 3x polička	1	

materiál: fólia + kov

Parenisko



kód	popis		
2170849	70x50x200 cm / 5x polička	1	

materiál: fólia + kov

Parenisko



kód	popis		
2170848	100x100x40 cm / 2x otvor	1	3,000

materiál: polykarbonát + hliník
odolné polykarbonátové panely proti krupobitiu
polykarbonát filtruje 99,9% škodlivého UV žiarenia
hrúbka skla: 4 mm

Parenisko

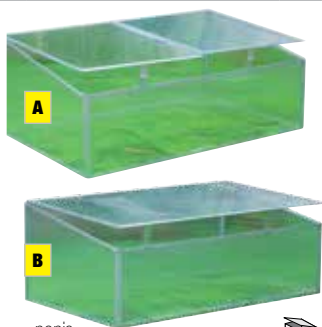

kód	popis		
2170464	A) 100x060x40 cm / 2x otvor	1	3,580
2170465	B) 100x060x40 cm / 1x otvor	1	7,800

materiál: polykarbonát + hliník
odolné polykarbonátové panely proti krupobitiu
polykarbonát filtruje 99,9% škodlivého UV žiarenia
hrúbka skla: 4 mm

Parenisko



kód	popis		
2170463	A) 130x070x62 cm / 2x otvor	1	4,200
2170258	B) 100x120x40 cm / 2x otvor	1	3,000

materiál: polykarbonát + hliník
odolné polykarbonátové panely proti krupobitiu
polykarbonát filtruje 99,9% škodlivého UV žiarenia
hrúbka skla: 4 mm

Skleník



kód	popis		
2170470	360x243x250 cm	1/3	

materiál: polykarbonát + hliník
odolné polykarbonátové panely proti krupobitiu
polykarbonát filtruje 99,9% škodlivého UV žiarenia
hliníková základňa

Komposter EVOGREEN



kód	popis		
255134	400 lit., zelená / 885x0800x885	1	
255136	600 lit., zelená / 910x1070x900	1	
255135	800 lit., zelená / 910x1345x900	1	

Komposter EVOGREEN Hobby



kód	popis		
255191	400 lit. / čierny / 885x0800x885	1	
255192	600 lit. / čierny / 910x1070x900	1	
255193	800 lit. / čierny / 910x1345x900	1	

Komposter COMPOGREEN



kód	popis		
255194	380 lit. / čierny	1	

Mini fóliovník



kód	popis		
217771	1x3,5 m, perforovaný	1	

Spona upínacia



kód	popis		
2170264	40x150 mm	10	0,170
2170265	40x150 mm	40	0,680

ACCESSORIES AT PLANTING

Miniparenisko, 24 priesad



kód	popis		
255287	33x23x10 cm / vrchnák	1	0,140

Miniparenisko, 3 priesady



kód	popis		
255285	57x24,5x13,5 cm / vrchnák	1	0,286

Miniparenisko



kód	popis		
255286	58x37,5x20 cm / vrchnák	1	0,483

Miniparenisko



kód	popis		
255363	36x22x13 cm / 24 priesad	1	
255288	55x15x13 cm / 36 priesad	1	0,176

Miniparenisko, 24 priesad



kód	popis		
255284	38x24,5x12,5 cm / vrchnák	1	0,146

Miniparenisko



kód	popis		
255289	19,7x14x11 cm / vrchnák	1	0,076

Kôš na cibulky ONION



kód	popis		
221911	plastový	1	0,100

Sadbovač, 18 priesad



kód	popis		
255290	56x32x8 cm	1	0,286

Sadbovač



kód	popis		
255291	35x23x5,6 cm / 24 priesad	1	0,040
255365	55x28x5x4,5 cm / 50 priesad	1	
255364	55x28x5x4,5 cm / 105 priesad	1	

Sadbovač



kód	popis		
255051	30x19x4,3 cm / 24 priesad	1	
255292	53,5x27x6,2 cm / 50 priesad	1	0,143

Sadbovač papierový



kód	popis		
255371	22x8x5,5 cm / 10 priesad	3	
255370	30x10x5 cm / 12 priesad	3	

Sadbovač papierový



kód	popis		
255367	∅ 60 mm, bal.30 ks	30	
255368	∅ 80 mm, bal.24 ks	24	

Sadbovač papierový



kód	popis		
255369	8x8 cm / bal.18 ks	18	

Sadbovač s lopatkou a pinzetou



kód	popis		
255366	38,5x25x6,5cm / na priesady	1	

Podlaha záhradná / 6ks



kód	popis		
21702780	A) 300x300 mm / vzor gravel	1	
21702781	B) 300x300 mm / vzor paving	1	

Podlaha záhradná / 6ks

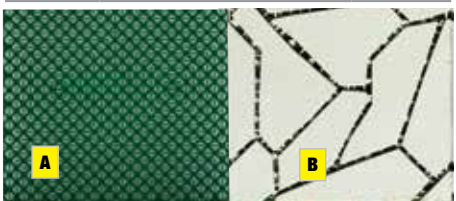

kód	popis		
21702782	A) 300x300 mm / vzor green grass	1	
21702783	B) 300x300 mm / vzor polygon	1	

Chodník záhradný



kód	popis		
221776	1500x300 mm	8	1,688

Buxus PVC



kód	popis		
2170328	180 mm	1	0,196
2170329	230 mm	1	0,344
2170330	300 mm	1	0,663
2170331	390 mm	1	1,425
2170332	520 mm	1	3,200

Valec



kód	popis		
2170327	500 mm / 38 lit.	1	

Kolík na sadenie

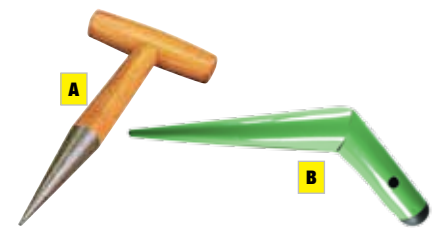

kód	popis		
211350	A) 300 mm	10	0,327
2110164	B) kovový	100	0,205

Kolík na sadenie

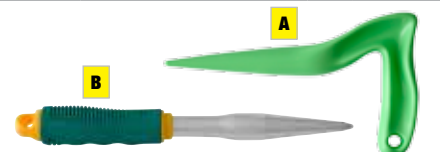

kód	popis		
2110094	A) typ L	1	0,200
211088	B) rovný	1	0,186

Sádzač cibulovín



kód	popis		
217250	Zn / 73 mm	18	0,361

Prevzdušňovač

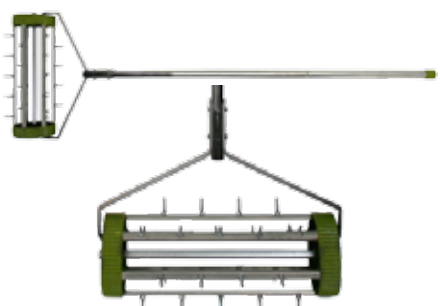

kód	popis		
2110039	prevzdušňovač trávnik	1	2,650

Valec s prevzdušňovacími kolíkmi



kód	popis		
217276	59/31 cm, kov	1	

Rozmetač sypkých materiálov



kód	popis		
2110240	2,7 lit. / 4xAA batéria	1	0,900

Batériovo poháňaný rozmetač. / S reguláciou posypu
Šírka posypu 2,5 m / Napájanie pomocou 4 AA batérií.
Prevádzkové napätie 6V. / Regulácia posypu, regulácia otáčok

Rozmetač sypkých materiálov



kód	popis		
211857	PE/ABS	10	0,660

Rozmetač sypkých materiálov



kód	popis		
213499	PP/PE, 2,0 lit.	1	

Sandále prevzdušňovacie



kód	popis		
211875	30 cm	20	0,650

Sejačka, strojček

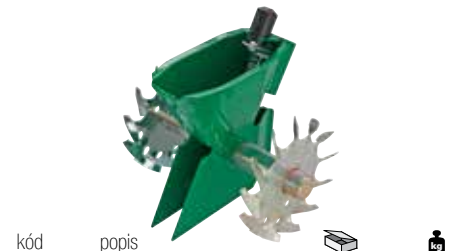

kód	popis		
111106	kov	1	1,100

Sejačka



kód	popis		
255269	plast, 7 cm		

Riadkovač



kód	popis		
211830	5-zubý, na palicu	1	

Kolík na riadkovanie



kód	popis		
215163	30cm / 2ks / šnúra 15m	1	0,330

Lopatka univerzálna



kód	popis		
2210640	CO-PP	24	0,138

Vozík na hnojivo



kód	popis		
217614	12 lit.	4	3,000

ACCESSORIES AT PLANTING

Textília na jahody



kód	popis		
217386	1,4x5 m	20	0,259

Textília tkaná



kód	popis		
217383	050 g/m ² - 0,9x10 m	25	0,608
217385	100 g/m ² - 01x10 m	20	1,200
217141	1,0x020 m	1	2,379
217472	1,5x010 m	1	
217265	2,1x100 m	1	

Textília netkaná

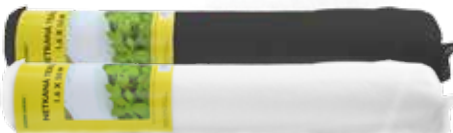

kód	popis		
217163	1.6x050 m, biela, 17g/m ²	1	1,500
217164	1.6x100 m, biela, 17g/m ²	1	2,830
217165	1.6x050 m, čierna, 50g/m ²	1	4,640
217166	1.6x100 m, čierna, 50g/m ²	1	8,640

Textília netkaná



kód	popis		
217605	1.6x005 m, biela, 17g/m ²	40	0,166
217606	1.6x010 m, biela, 17g/m ²	20	0,335
2170261	2,0x005 m, biela, 17g/m ²	1	
2170262	2,0x010 m, biela, 17g/m ²	1	
217688	1.6x005 m, čierna, 50g/m ²	20	0,440
217689	1.6x010 m, čierna, 50g/m ²	10	0,880
2170259	3,2x005 m, čierna, 50g/m ²	1	
2170260	3,2x010 m, čierna, 50g/m ²	1	

Fólia čierna, 20g/m²



kód	popis		
217384	1,2x10 m	25	0,280
2170263	1,2x25 m	1	

Sieť na uhorky



kód	popis		
2210351	1,5x10 m	20	0,200
2210352	1,5x20 m	10	0,420
2210353	2,0x05 m	20	0,160
2210350	2,0x10 m	10	0,320
2210354	2,0x100 m	1	2,900

Sieť proti vtákom, plast

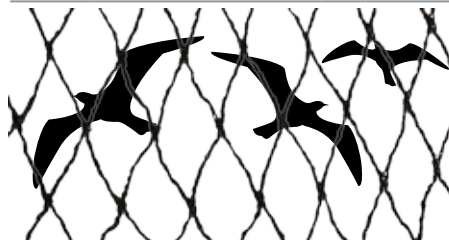

kód	popis		
2210645	02x05 m	1	0,237
2210646	04x10 m	1	0,860
2210647	08x08 m	1	1,380
2210648	12x25 m	1	6,400

Sieť proti krtom, plast



kód	popis		
2211021	12x12 mm; 1m; L-200 m	1	
2211022	12x12 mm; 2m; L-200 m	1	
2211023	16x16 mm; 1m; L-200 m	1	
2211024	16x16 mm; 2m; L-200 m	1	

Plachta zakrývacia 65g/m²



kód	popis		
2170087	2,0x03,0 m	1	
2170088	2,0x04,0 m	1	
2170089	3,0x04,0 m	1	
2170090	3,0x05,0 m	1	
2170091	4,0x05,0 m	1	
2170092	4,0x06,0 m	1	
2170093	5,0x08,0 m	1	
2170094	6,0x10,0 m	1	
2170095	8,0x12,0 m	1	
2170096	10,0x15,0 m	1	

Plachta zakrývacia 80g/m²



kód	popis		
2170022	2,0x03,0 m	1	
2170081	2,0x04,0 m	1	
2170023	3,0x04,0 m	1	
2170082	3,0x05,0 m	1	
2170024	4,0x05,0 m	1	
2170025	4,0x06,0 m	1	
2170083	5,0x08,0 m	1	
2170026	6,0x10,0 m	1	
2170084	8,0x12,0 m	1	
2170085	10,0x15,0 m	1	

Plachta zakrývacia 90g/m²



kód	popis		
217966	2,0x03,0 m	40	0,580
217175	2,0x04,0 m	30	0,725
217033	3,0x04,0 m	20	1,000
217967	3,0x05,0 m	15	1,000
217066	4,0x05,0 m	10	1,750
217061	4,0x06,0 m	10	1,000
217957	5,0x08,0 m	5	3,680
217043	6,0x10,0 m	4	5,020
217318	8,0x12,0 m	3	1,000
217657	10,0x15,0 m	2	1,000

Plachta zakrývacia 120g/m²

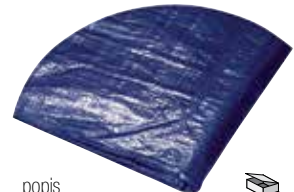

kód	popis		
217658	Ø 3,6 m / okrúhla	1	3,500
217317	Ø 4,5 m / okrúhla	1	4,000
217365	Ø 5,5 m / okrúhla	1	5,000

Plachta zakrývacia 140g/m²



kód	popis		
2170875	2,0x03,0 m	1	
2170876	3,0x04,0 m	1	
2170877	4,0x05,0 m	1	
2170878	4,0x06,0 m	1	
2170879	5,0x08,0 m	1	
2170880	8,0x12,0 m	1	
2170881	10,0x15,0 m	1	

Silon do kosačky Economy



kód	popis		
111618	1,3 mm, kruh	30	0,035
111620	1,6 mm, kruh	20	0,050
111622	2,0 mm, kruh	20	0,070
111624	2,4 mm, kruh	10	0,102
111626	3,0 mm, kruh	10	0,147
111619	1,3 mm, hviezda	30	0,032
111621	1,6 mm, hviezda	20	0,050
111623	2,0 mm, hviezda	20	0,062
111625	2,4 mm, hviezda	10	0,092
111627	3,0 mm, hviezda	10	0,128

Silon do kosačky Professional



kód	popis		
111722	1,3 mm, kruh	30	0,035
111724	1,6 mm, kruh	20	0,051
111726	2,0 mm, kruh	20	0,070
111728	2,4 mm, kruh	10	0,102
111730	3,0 mm, kruh	10	0,147
111723	1,3 mm, hviezda	30	0,032
111725	1,6 mm, hviezda	20	0,050
111727	2,0 mm, hviezda	20	0,062
111729	2,4 mm, hviezda	10	0,090
111731	3,0 mm, hviezda	10	0,120

Silon do kosačky • TRI-CUT



kód	popis		
111660	2,4 mm, 25m, trojhranný	1	0,165
111680	2,7 mm, 20m, trojhranný	1	0,166
111682	3,0 mm, 15m, trojhranný	1	0,156

Silon do kosačky, Twist Silent Pro



kód	popis		
111900	2,0 mm 15m	10	0,077
111901	2,4 mm 15m	10	0,106
111902	3,0 mm 15m	10	0,144

Silon do kosačky • ProCon



kód	popis		
111960	2,40 mm L-239 m, hranatý	8	1,788
111961	2,70 mm L-197 m, hranatý	8	1,788
111962	3,00 mm L-153 m, hranatý	8	1,890
111954	2,40 mm L-262 m, okrúhly	8	1,890
111955	2,70 mm L-216 m, okrúhly	8	1,788
111956	3,00 mm L-168 m, okrúhly	8	1,890

Silon do kosačky • Alulon



kód	popis		
111630	2,40 mm L-20 m, hranatý	10	0,140
111635	2,70 mm L-15 m, hranatý	10	0,128
111637	3,00 mm L-12 m, hranatý	10	0,128
111282	2,40 mm L-20 m, okrúhly	10	0,154
111278	2,70 mm L-20 m, okrúhly	1	0,140
111270	3,00 mm L-20 m, okrúhly	1	0,130

Silon do kosačky • DualCut



kód	popis		
111646	2,40 mm L-20 m, hranatý	10	0,150
111649	2,70 mm L-15 m, hranatý	10	0,140
111676	3,00 mm L-12 m, hranatý	10	0,140
111638	2,40 mm L-20 m, okrúhly	10	0,166
111639	2,70 mm L-20 m, okrúhly	10	0,150
111643	3,00 mm L-20 m, okrúhly	10	0,150

Silon do kosačky



kód	popis		
111273	1,65 mm, 3,5 m	36	

Tvarnica zatrávňovacia čierna

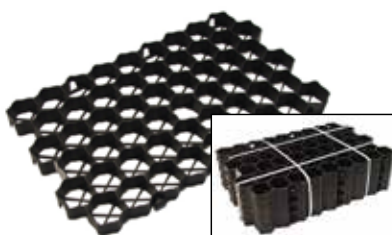

kód	popis		
2170458	590x395x30 mm, 4 ks (0,93m²)	4	

Plastová obruba



kód	popis		
2211073	4,8 m / 24 úchyty	1	

Nenahraditeľný pomocník pri záhradných prácach architekta, ale aj domáceho kreatívneho záhradníka. Plastové lemy sú mrazuvzdorné, pevné a zároveň pružné - môžu sa ohýbať podľa potreby. Balíček obsahuje 8 ks lemov s celkovou dĺžkou 4,8 m a plastové úchyty - harpúny 24 ks na prichytenie k zemi.

Plastová obruba



kód	popis		
2211074	8 m / 28 úchyty	1	

Nenahraditeľný pomocník pri záhradných prácach architekta, ale aj domáceho kreatívneho záhradníka. Plastové lemy sú mrazuvzdorné, pevné a zároveň pružné - môžu sa ohýbať podľa potreby. Balíček obsahuje 8 ks lemov s celkovou dĺžkou 8 m a plastové úchyty - harpúny 28 ks na prichytenie k zemi.

Klinec HARPOON PEG 120



kód	popis		
2210162	67x38x209 mm, bal. 20ks	1	
2210175	67x38x209 mm, bal. 50ks	1	

Oplotenie rákos, vrba, bambus

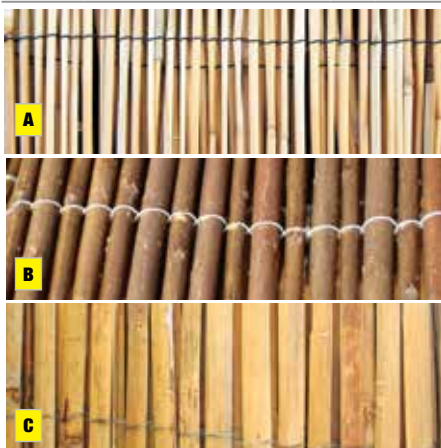

kód	popis	balenie	kg
2210502	A) Rákos trstený 1.0 m, L-5 m	1	3,000
2210503	A) Rákos trstený 1.5 m, L-5 m	1	5,000
2210504	A) Rákos trstený 2.0 m, L-5 m	1	8,500
2210868	B) Vrba prútená 1000 mm, L-5 m	1	
2210869	B) Vrba prútená 1500 mm, L-5 m	1	
2210870	B) Vrba prútená 2000 mm, L-5 m	1	
2210018	C) Bambus štiepaný 1.0 m, L-5 m	5	6,300
2210088	C) Bambus štiepaný 1.5 m, L-5 m	5	9,700
2210091	C) Bambus štiepaný 2.0 m, L-5 m	5	12,100

Tkanina tieniaca HDPE

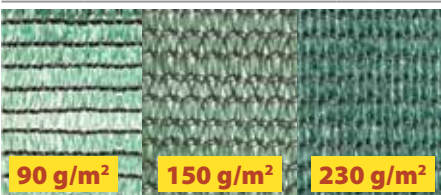

kód	popis	balenie	kg
217138	Hobby 1.0 m, L-10 m, 090 g/m²	30	1,388
217139	Hobby 1.5 m, L-10 m, 090 g/m²	30	1,666
2170608	Hobby 1.8 m, L-10 m, 090 g/m²	1	
217146	Hobby 2.0 m, L-10 m, 090 g/m²	30	2,742
2170104	Hobby 1.5 m, L-50 m, 090 g/m²	1	
2170105	Hobby 1.8 m, L-50 m, 090 g/m²	1	7,970
2170106	Hobby 2.0 m, L-50 m, 090 g/m²	1	8,800
217152	Popular 1.0 m, L-10 m, 150 g/m²	20	1,650
2170609	Popular 1.2 m, L-10 m, 150 g/m²	1	
2170610	Popular 1.8 m, L-10 m, 150 g/m²	1	
217136	Popular 1.5 m, L-10 m, 150 g/m²	20	2,150
217137	Popular 2.0 m, L-10 m, 150 g/m²	20	2,850
2171093	Popular 1.0 m, L-25 m, 150 g/m²	1	
2171095	Popular 1.5 m, L-25 m, 150 g/m²	1	
2171096	Popular 2.0 m, L-25 m, 150 g/m²	1	
2170123	Popular 1.5 m, L-50 m, 150 g/m²	1	10,760
2170124	Popular 1.8 m, L-50 m, 150 g/m²	1	13,000
2170125	Popular 2.0 m, L-50 m, 150 g/m²	1	15,000
2170460	Privat 1.0 m, L-10 m, 230 g/m²	1	
2170640	Privat 1.2 m, L-10 m, 230 g/m²	1	
2170461	Privat 1.5 m, L-10 m, 230 g/m²	1	
2170641	Privat 1.8 m, L-10 m, 230 g/m²	1	
2170462	Privat 2.0 m, L-10 m, 230 g/m²	1	
2170611	Privat 1.0 m, L-50 m, 230 g/m²	1	
2170612	Privat 1.2 m, L-50 m, 230 g/m²	1	
2170505	Privat 1.5 m, L-50 m, 230 g/m²	1	
2170102	Privat 1.8 m, L-50 m, 230 g/m²	1	
2170506	Privat 2.0 m, L-50 m, 230 g/m²	1	

* NOVÉ ROZMERY TKANIN

Okrasné oplotenie



kód	popis	balenie	kg
2170114	A) 0.5x0.5 m / vzor listie	12	0,466
2170110	B) 1.0x3.0 m / vzor svetla tráva	2	3,500
2170112	B) 2.0x3.0 m / vzor svetla tráva	2	6,900
2170107	C) 1.0x3.0 m / vzor tmava tráva	2	3,500
2170108	C) 1.5x3.0 m / vzor tmava tráva	2	5,250
2170109	C) 2.0x3.0 m / vzor tmava tráva	2	6,900

Palisada Cellfast



kód	popis	balenie	kg
2170007	3 Maxi, 2.1 m, hnedá	1	1,665
2170006	5 Standard, 2.3 m, hnedá	1	1,980

Palisada IHAP Happy Grass



kód	popis	balenie	kg
217817	70mm; 3,1m; Terakota	1	0,800
217996	70mm; 3,1m; hnedá	1	0,800

Palisada



kód	popis	balenie	kg
217172	225/140mm, hnedá, 2,1m	1	0,800
217699	225/140mm, Terakota, 2,1m	1	0,800
217818	240/155mm, Terakota, 2,7m	1	0,800
217821	255/140mm, hnedá, 2,1m	1	0,800
217191	255/140mm, Terakota, 2,1m	1	0,800

Palisada IPBO



kód	popis	balenie	kg
217819	A) 2,5 m, 228/130 mm, hnedá	1	1,884
217822	B) 2,5 m, 228/130 mm, terakota	1	1,656

Plot záhradný, plastový

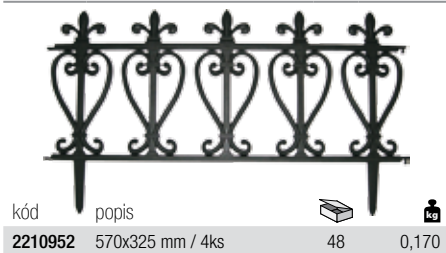

kód	popis	balenie	kg
2210952	570x325 mm / 4ks	48	0,170

Plot záhradný, plastový



kód	popis	balenie	kg
2210953	470x245 mm / Ø93cm / 6ks	48	0,170

Plot plastový, záhradný

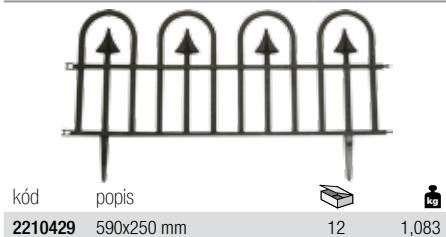

kód	popis	balenie	kg
2210429	590x250 mm	12	1,083

Plot plastový, záhradný



kód	popis	balenie	kg
2210767	640x340 mm	48	0,170

Plot plastový, záhradný

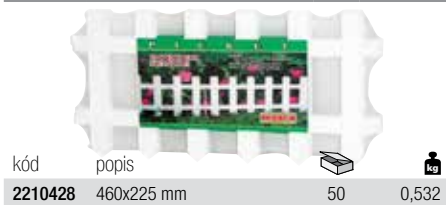

kód	popis	balenie	kg
2210428	460x225 mm	50	0,532

Spony na uchytenie tkaniny



kód	popis	balenie	kg
2170705	A) plast, bal. 20ks	20	
2170706	B) plast, bal. 20ks	20	

Pletivo Winet Zn



žiarovo zinkované
záhradné

kód	popis		
431020	100/60/2,15 mm	25	
431021	125/60/2,15 mm	25	
431022	150/60/2,15 mm	25	1,338
431023	160/60/2,15 mm	25	1,428
431024	180/60/2,15 mm	25	1,606
431025	200/60/2,15 mm	25	

Pletivo Winet PVC



poplastované
záhradné

kód	popis		
431004	100/60/2,20 mm	25	0,709
431068	125/60/2,20 mm	25	0,887
431100	150/60/2,20 mm	25	1,064
431101	160/60/2,20 mm	25	1,135
431102	180/60/2,20 mm	25	1,277
431191	200/60/2,20 mm	25	1,418

Pletivo WeWinet, zvrávané



žiarovo zinkované
záhradné

kód	popis		
431144	10x10x0,8 mm, výška 1 m	25	15,800
431145	12x12x0,8 mm, výška 1 m	25	12,900
431146	16x16x1,2 mm, výška 1 m	25	24,500
431147	19x19x1,4 mm, výška 1 m	25	27,200

Pletivo zvrávané, pvc



poplastované
záhradné

kód	popis		
431244	10x0,8 mm, výška 0.5 m	10	
431243	19x1,4 mm, výška 0.5 m	10	
431011	19x1,4 mm, výška 1.0 m	25	
431260	25x2,5 mm, výška 1 m	25	
431259	16x1,2 mm, výška 1 m	25	
431258	13x1,2 mm, výška 1 m	25	

Pletivo GardenET, okrasné

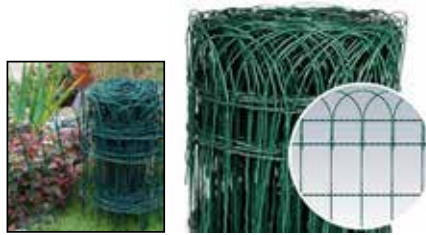

kód	popis		
431009	400 mm / L-25 m / plast	1	
431007	650 mm / L-25 m / plast	1	
431005	900 mm / L-25 m / plast	1	

Bránka záhradná, Fe+Pvc



poplastované
záhradná

kód	popis		
432053	1500x1000 mm	1	23,000

Stĺpik a vzpera k oploteniu, Zn

Stĺpik pozinkovaný



Vzpera pozinkovaná



kód	popis		
431189	stĺpik 48x2000x1,50 mm	1	
431183	stĺpik 48x2200x1,50 mm	1	
431190	stĺpik 48x2300x1,50 mm	1	
431201	stĺpik 48x2400x1,50 mm	1	
431188	stĺpik 48x2500x1,50 mm	1	
431237	stĺpik 48x2600x1,50 mm	1	
431202	vzpera 38x1500x1,50 mm	1	
431156	vzpera 38x2000x1,50 mm	1	
431264	vzpera 38x2200x1,50 mm	1	

Stĺpik a vzpera k oploteniu, Zn+Pvc

Stĺpik poplastovaný



Vzpera poplastovaná



kód	popis		
432060	stĺpik 38x2000x1,25 mm	1	
431252	stĺpik 48x1500x1,50 mm	1	
431262	stĺpik 48x1750x1,50 mm	1	
431255	stĺpik 48x2000x1,50 mm	1	
432062	stĺpik 48x2200x1,50 mm	1	
432085	stĺpik 48x2500x1,50 mm	1	
431253	vzpera 38x1500x1,25 mm	1	
431263	vzpera 38x1750x1,25 mm	1	
432063	vzpera 38x2000x1,25 mm	1	
432084	vzpera 48x2200x1,25 mm	1	
431205	vzpera 38x2200x1,50 mm	1	
431108	vzpera 38x2500x1,25 mm	1	

Pletivo Eurofence, 1 a 2 lemové

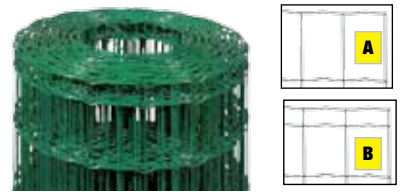

kód	popis		
431221	A) 1000/100x50/2.20 mm	25	14,400
431223	A) 1250/100x50/2.20 mm	25	10,000
431179	A) 1500/100x50/2.20 mm	25	10,000
431218	A) 1600/100x50/2.20 mm	25	10,000
431180	A) 1800/100x50/2.20 mm	25	26,900
431182	A) 2000/100x50/2.20 mm	25	28,800
431214	B) 1000/100x50/2.20 mm	25	15,300
431215	B) 1250/100x50/2.20 mm	25	18,900
431113	B) 1500/100x50/2.20 mm	25	21,700
431217	B) 1600/100x50/2.20 mm	25	23,200
431177	B) 1800/100x50/2.20 mm	25	10,000
431178	B) 2000/100x50/2.20 mm	25	29,600

Pletivo Hewinet, Zn



žiarovo zinkované

kód	popis		
431238	13 mm, 0.5 m	10	
431239	20 mm, 0.5 m	10	
431170	13 mm, 0.5 m	25	0,210
431118	13 mm, 1.0 m	25	0,420
431093	13 mm, 1.0 m	50	0,420
431171	16 mm, 0.5 m	25	0,180
431119	16 mm, 1.0 m	25	0,370
431094	16 mm, 1.0 m	50	0,370
431120	20 mm, 1.0 m	25	0,310
431095	20 mm, 1.0 m	50	0,310
431121	25 mm, 1.0 m	25	0,336
431096	25 mm, 1.0 m	50	0,330

Pletivo Hewinet, Pvc



poplastované

kód	popis		
431240	13 mm, 0.5 m	10	
431245	20 mm, 0.5 m	10	
431006	13 mm, 1 m	25	0,350
431008	16 mm, 1 m	25	0,300
431010	20 mm, 1 m	25	0,250
431013	25 mm, 1 m	25	0,280

Pletivo zvrávané, Zn



žiarovo zinkované

kód	popis		
431241	10x0,8 mm, výška 0,5 m	10	

Pletivo Alpinet, zelené



kód	popis		
431003	1.0 m, L-25m, 5 mm oko	1	
431012	1.0 m, L-25m, 10 mm oko	1	

Drôt viazací



kód	popis		
217815	A) 3 mm, L-5 m, SoftTwist	24	0,120
217814	A) 5 mm, L-5 m, SoftTwist	24	0,198
2170136	B) L-8 m	1	
217816	B) L-10 m	48	0,156

Drôt viazací GardenTwist



kód	popis		
217368	0,4x3,0x100 mm	1	0,030
217369	0,4x3,0x150 mm	100	0,040
217370	0,4x3,0x200 mm	100	0,050
217371	0,4x3,0x250 mm	100	0,060
217813	0,4x3,0x300 mm	1	0,100

Drôt záhradný GardenWire, 100g



kód	popis		
431089	Fe žihnaný • Ø0,65mm	25	0,100
431132	pozinkovaný • Ø0,65mm	25	0,100
431133	poplastovaný zelený • Ø0,65mm	25	0,100
431098	poplastovaný čierny • Ø0,65mm	25	0,100

Drôt GardenWire.InBas



kód	popis / m v balení		
431169	Zn 1,00 mm, L-50 m	24	0,310

Drôt viazací, PVC, so štikačom



kód	popis		
217151	L-015 m	50	0,058
217202	L-020 m	50	0,058
217203	L-030 m	144	0,083
217207	L-050 m	144	0,140
217204	L-100 m	48	0,210

Lem na trávnik



kód	popis		
2212057	100 mm, L-09 m, hnedý	24	0,440
2210231	100 mm, L-09 m, zelený	24	0,440
2210232	150 mm, L-09 m, zelený	24	0,670
2210356	150 mm, L-10 m, hnedý	36	0,670
2210357	150 mm, L-10 m, hnedý	24	0,670
2210768	200 mm, L-09 m, zelený	18	0,847
2210954	200 mm, L-09 m, hnedý	18	0,847

Obruba na trávnik



kód	popis		
2210359	120 mm, L-5 m, hnedá	1	0,800
2210358	120 mm, L-5 m, zelená	1	0,800

Drôt GWire.Sc, cievka



kód	popis / m v balení		
431126	0,70 mm L-100 m / Zn	60	0,310
431127	0,90 mm L-050 m / Zn	60	0,250
431128	1,10 mm L-050 m / Zn	60	0,380
431129	1,30 mm L-050 m / Zn	60	0,530
431130	1,50 mm L-030 m / Zn	60	0,400
431131	1,80 mm L-030 m / Zn	1	0,610
431122	0,80 mm L-075 m / Pvc	60	0,190
431123	1,20 mm L-050 m / Pvc	60	0,190
431124	1,40 mm L-050 m / Pvc	60	0,310
431125	1,60 mm L-050 m / Pvc	36	0,460

Drôt GWire, malé balenie



kód	popis / m v balení		
431138	0,80 mm L-025 m / Zn	60	0,110
431139	1,00 mm L-025 m / Zn	60	0,170
431140	1,20 mm L-025 m / Zn	60	0,240
431141	1,40 mm L-025 m / Zn	60	0,320
431142	1,80 mm L-025 m / Zn	60	0,510
431143	2,50 mm L-025 m / Zn	25	0,960
431064	3,15 mm L-078 m / Zn	5	4,600
431134	0,80 mm L-075 m / Pvc	60	0,190
431222	1,00 mm L-050 m / Pvc	60	0,210
431135	1,20 mm L-026 m / Pvc	60	0,110
431136	1,40 mm L-010 m / Pvc	60	0,080
431137	2,00 mm L-025 m / Pvc	60	0,370
431001	2,80 mm L-078 m / Pvc	10	2,010
431062	3,50 mm L-078 m / Pvc	10	3,510

Sítka na odkvap / CO-PP

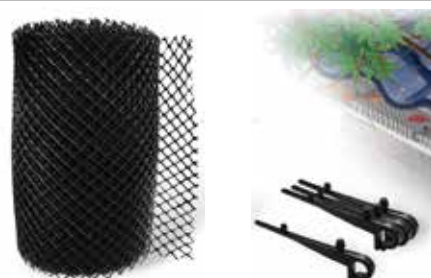

kód	popis		
2170121	zabrání zaneseniu lístím a iného	24	0,458

Objímka na stípek



kód	popis		
432064	040 mm	100	0,020
432065	050 mm	100	0,020
432136	060 mm	100	0,020

Napínák drôtu



kód	popis		
217545	Zn	100	0,120
217649	Pvc	100	0,120

Čiapočka na stípek, plast



kód	popis		
432078	38 mm	200	0,007
432079	40 mm	200	0,008
432080	50 mm	200	0,012
432119	60 mm	1	0,015

Príchytky drôtu



kód	popis		
432077	plastová, so skrutkou	10	0,010

Drôt ostnany Barwire



kód	popis		
431117	2,00 mm	50	0,080
431091	2,00 mm	100	0,080
431092	2,24 mm	250	0,080
431227	2,10 mm / PVC	50	0,058
431228	2,10 mm / PVC	100	0,090

Postrekovač Garden na plece, 100% tesniaci



kód	popis	
256600	11.0/11.60 lit.; tlak 2/5 bar; piest nypnen; plocha pokrytia 500/1000 m ² ; dĺžka postreku 900 cm; výška postreku 450 cm; teleskopická rukoväť 70-110 cm	1
256601	13.5/14.25 lit.; tlak 2/5 bar; piest nypnen; plocha pokrytia 500/1500 m ² ; dĺžka postreku 900 cm; výška postreku 450 cm; teleskopická rukoväť 70-110 cm	1
256602	19.0/20.25 lit.; tlak 2/5 bar; piest nypnen; plocha pokrytia 500/2000 m ² ; dĺžka postreku 900 cm; výška postreku 450 cm; teleskopická rukoväť 70-110 cm	1

Postrekovač Garden na rameno



kód	popis	
256034	3.5/05.65 lit.; tlak 3 bar; plocha pokrytia 100/500 m ² ; dĺžka postreku 900 cm; výška postreku 450 cm; teleskopická rukoväť 65 cm	1
256002	5.5/07.05 lit.; tlak 3 bar; plocha pokrytia 100/800 m ² ; dĺžka postreku 900 cm; výška postreku 450 cm; teleskopická rukoväť 65 cm	1
256599	8.5/10.75 lit.; tlak 3 bar; plocha pokrytia 100/1000 m ² ; dĺžka postreku 900 cm; výška postreku 450 cm; teleskopická rukoväť 65 cm	1

Postrekovač Garden ručný



kód	popis	
256003	1.3/1.5 lit.; tlak 2 bar; dĺžka postreku 800 cm; výška postreku 400 cm; s ovzdušňovačom	1
256038	1.8/2.0 lit.; tlak 2 bar; dĺžka postreku 800 cm; výška postreku 400 cm; s ovzdušňovačom	1

Postrekovač na plece



kód	popis		
256748	3 lit.	1	1,800
256749	6 lit.	1	2,100
Výška postreku: 450 cm Dĺžka postreku: 900 cm Plocha pokrytia: 100/500 m ² Tlak: 3 bar - rukoväť 40-65 cm			

Postrekovač na plece, nyplén



kód	popis		
256354	13 lit.	1	3,600
256355	16 lit.	1	3,800
Výška postreku: 450 cm Dĺžka postreku: 900 cm Plocha pokrytia: 500/1000 m ² Tlak: 2/5 bar - teleskopická rukoväť 70-110 cm - s regulátorom tlaku			

Postrekovač na plece



kód	popis		
256750	16 lit.	1	4,300
Plocha pokrytia: 500/2000 m ² Dĺžka postreku: 1200 cm Výška postreku: 800 cm Tlak: 2/6 bar - teleskopická rukoväť 70-110 cm - s regulátorom tlaku			

Postrekovač ručný



kód	popis		
256747	0.7 lit, s ložiskom; Výška postreku: 350 cm; Dĺžka postreku: 700 cm	1	0,099

Postrekovač ručný



kód	popis		
256096	1.8/2.0 lit; Tlak: 2 bar; Výška postreku: 400 cm; Dĺžka postreku: 800 cm	1	0,473

Postrekovač ručný



kód	popis		
256761	1.8/2.0 lit.	1	

Postrekovač elektrický



kód	popis		
256746	Napájanie: 12 V	1	
256363	náhradná motor	1	2,000
Výška postreku: 350 cm Dĺžka postreku: 700 cm Plocha pokrytia: 100/600 m ² Objem: 6/8 l Pracovná doba postrekovania: 4 h Doba nabíjania: 2 h Kapacita postrekovania 1 sady batérií: 80-100 l - teleskopická rukoväť 65 cm - vhodný do záhrady - trvanlivý a spoľahlivý vďaka motorovej jednotke oddelenej od postrekovanej kvapaliny			



Použitie postrekovačov s označením EPDM

Čistenie
Čističe
Odstraňovače usadenín
Organické a anorganické bielidlá

Dezinfekcia
Alkoholy
Dezinfikátory

Mazanie
Hydraulické tekutiny



Použitie postrekovačov s označením FPM Viton

Čistenie
Palivá
Kyseliny

Stavba
Odstraňovače vodného kameňa
Vodovzdorné impregnáty
Protiplesňové prípravky

Mazanie
Olejové lubrikanty



Postrekovače ALTA EPDM



kód	popis	
256714	A) 1,8/2,0 lit.; tlak 2 bar; dĺžka postreku 800 cm; výška postreku 400 cm; s ovzdušňovačom	1
256715	B) 5,5/7,05 lit.; tlak 3 bar; plocha pokrytia 100/500 m ² ; dĺžka postreku 900 cm; výška postreku 450 cm; teleskopická rúkoväť 65 cm	1

Postrekovače ALTA FPM Viton

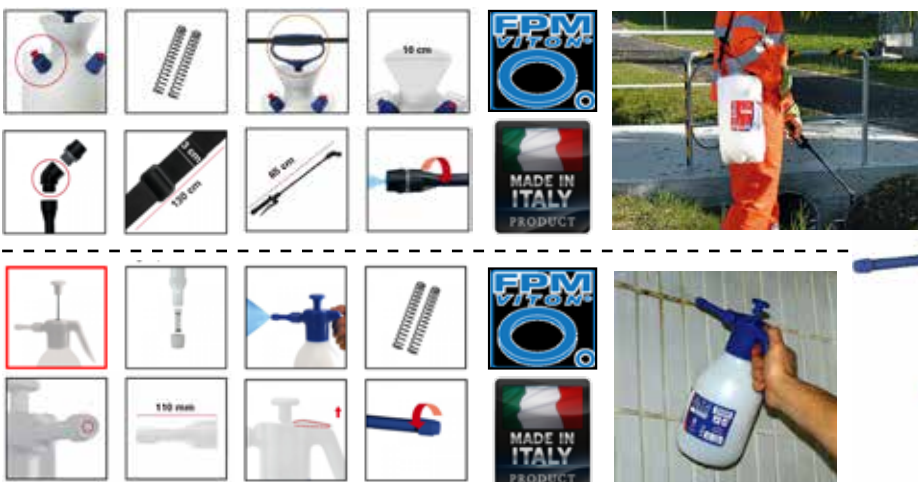

kód	popis	
256712	A) 1,8/2,0 lit.; tlak 2 bar; dĺžka postreku 800 cm; výška postreku 400 cm; s ovzdušňovačom	1
256713	B) 5,5/7,05 lit.; tlak 3 bar; plocha pokrytia 100/500 m ² ; dĺžka postreku 900 cm; výška postreku 450 cm; teleskopická rúkoväť 65 cm	1

Postrekovač VIVA7, elektrický

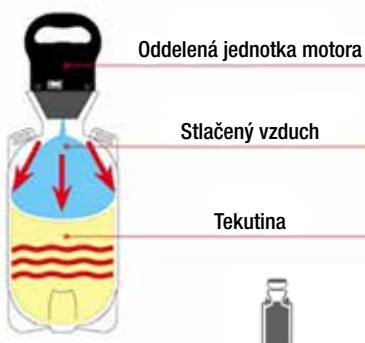

Napájanie: 12 V.
Kapacita postrekovania 1 sady batérií: 80-100 lit.
Vhodný pre záhrady.
Trvanlivý a spoľahlivý vďaka motorovej jednotke oddelenej od postrekovanej kvapaliny.



Objem kvapaliny v postrekovači / čas potrebný na dosiahnutie tlaku: 6 litre / 0'30", 4 litre / 2'00", 2 litre / 3'00"

6 lt	⇒	0'30"
4 lt	⇒	2'00"
2 lt	⇒	3'00"

kód	popis	
256095	5.5/7.0 lit.; tlak 2 bar; plocha pokrytia 500 m ² ; dĺžka postreku 700 cm; výška postreku 350 cm; riemenný prietok: 620 cm ³ /min.	1

Postrekovač ručný



kód	popis	kg
256717	A) 1000 ml.; dĺžka postreku 700 cm; výška postreku 350 cm	1
256094	B) 480 ml; dĺžka postreku 700 cm; výška postreku 350 cm; ložisko	1
256005	B) 1000 ml; dĺžka postreku 700 cm; výška postreku 350 cm; ložisko	1

Náhradné diely k postrekovačom



kód	popis	kompatibilné pre
256704	1) 5-7-10 lit.	MARY; LADY; GAMMA; STILLA; GARDEN; BRIO
256703	2) 5-7-10 lit.	MARY; LADY; GAMMA; STILLA; GARDEN; BRIO
256702	3) 5-7-10 lit.	MARY; LADY; GAMMA; STILLA; GARDEN; BRIO
256708	4) 12-15-22 lit.	OLIMPIA; GARDEN; ROSY; MIURA; GAIA; TIGRA
256711	5) 12-15-22 lit.	OLIMPIA; GARDEN; ROSY; MIURA; GAIA; TIGRA
256686	6) 12-15-22 lit.	OLIMPIA; GARDEN; ROSY; MIURA; GAIA; TIGRA
256707	7) 12-15-22 lit.	OLIMPIA; GARDEN; ROSY; MIURA; GAIA; TIGRA
256700	8) 1,5-2,0 lit.	BRIO; FLORIS; EVA; BIBA; THEMA; GARDEN
256701	9) 1,5-2,0 lit.	BRIO; FLORIS; EVA; BIBA; THEMA; GARDEN
256687	10) 5-7-10 lit.	MARY; LADY; GAMMA; STILLA; GARDEN; BRIO
256684	11) 12-15-22 lit.	OLIMPIA; GARDEN; ROSY; MIURA; GAIA; TIGRA
256685	12) 12-15-22 lit.	OLIMPIA; GARDEN; ROSY; MIURA; GAIA; TIGRA

Postrekovač ručný



kód	popis	kg
256603	1.8/2.0 lit.; tlak 2 bar; dĺžka postreku 800 cm; výška postreku 400 cm; s ovzdušňovačom	1
256766	1.8/2.0 lit.; tlak 2 bar; dĺžka postreku 800 cm; výška postreku 400 cm; s ovzdušňovačom, 360° otočná hlavica	1

Príslušenstvo k postrekovačom

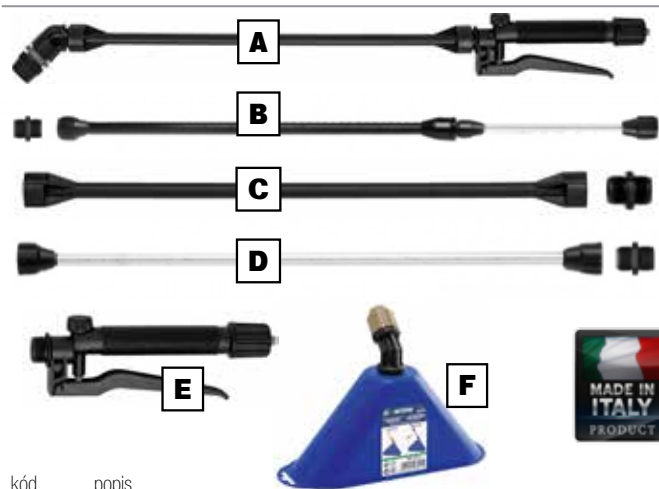

kód	popis
256679	A) tyč s rukoväťou 60 cm
256696	B) tyč teleskopická 50-90 cm
256697	C) tyč 40 cm
256698	D) tyč 50 cm
256680	E) rukoväť
256682	F) zvon malý standard, max. uhol rozstreku 60°
256681	F) zvon veľký maxi, max. uhol rozstreku 60°

Príslušenstvo k postrekovačom



kód	popis
256695	A) dýza, max. uhol rozstreku 60°
256692	B) dýza, max. uhol rozstreku 160°
256693	C) 4x nástavec + dýza, max. uhol rozstreku 30°-40°-60°-95°
256694	D) 2x dýza, max. uhol rozstreku 60°
256699	E) spojka
256691	F) 1x nástavec + kľbová dýza, max. uhol rozstreku 60°
256683	G) filter

Postrekovač pojazdny



kód	popis		
256360	12 lit.	1	1,000
256575	náhradná pumpa / 39x13,5 cm	1	
224656	náhradná sada tesnení	1	0,008

Postrekovač na plece Bella



Ideálny pre skleníky, pareniská a malé záhradky

kód	popis		
256290	3 lit	6	1,000
256009	5 lit	6	1,080
256104	8 lit	6	1,750
222051	náhradná sada tesnení	1	0,008
256429	náhradná tryska, plastová	1	

Tryska



kód	popis		
256577	8 mm, plastová	1	

Tryska



kód	popis		
256562	8 mm, plastová	1	

Tryska



kód	popis		
256576	2 v 1, Double	1	

Tryska



kód	popis		
256550	ohybná, plastová	1	

Postrekovač na plece



kód	popis		
256383	5 lit., s manometrom	20	2,680
256574	náhradná pumpa / 40x13,5 cm	1	
224659	náhradná sada tesnení	1	0,008

Postrekovač ručný



kód	popis		
256130	1,5 lit / s ovzdušňovačom	20	0,450
256131	2,0 lit / s ovzdušňovačom	20	0,400

Postrekovač ručný



kód	popis		
256458	1,5 lit / s ovzdušňovačom	20	0,600
256459	2,0 lit / s ovzdušňovačom	20	0,660

Rukoväť



kód	popis		
256559	plast	1	

Rukoväť



kód	popis		
256436	plast	10	0,100

Rozprašovač ručný



kód	popis		
256101	0500 ml	1	0,065
256046	1000 ml	60	0,100

Tyč s herbicídny m zvonom



kód	popis		
256573	sklolaminát, 50 cm, zvon malý 230x90x130 mm	1	
256572	sklolaminát, 50 cm, zvon veľký 370x140x200 mm	1	

Tyče k postrekovačom



kód	popis		
256569	A) sklolaminát 37 cm, 8 mm	1	
256424	B) kovová 37 cm, 8 mm	1	

Tyče k postrekovačom



kód	popis		
256463	A) Alu, teleskop 50-100 cm, 8 mm	1	
256416	B) teleskop, 93-250 cm, Alu, 8 mm	1	

Postrekovač chrbtový

STREND PRO



kód	popis		
256012	12 lit - NS12	1	2,790
256555	16 lit - NS16	1	2,410
256169	18 lit - NS18	1	2,800
256013	20 lit - NS20A	1	3,500

256593 náhradná hadica
256052 náhradná tyč
256022 náhradná pumpa
256362 náhradná sada tesnení
256579 piest náhradný

Postrekovač na plece

STREND PRO



kód	popis		
256168	16 lit.	1	2,420
256580	náhradná pumpa	1	

Postrekovač

STREND PRO



kód	popis		
256462	na PET fľašu	1	0,090

Postrekovač na plece

STREND PRO



kód	popis		
256011	10 lit	1	1,500
256578	náhradná pumpa	1	

Postrekovač

STREND PRO



kód	popis		
256524	1,25 lit. / s ovzdušňovačom	1	0,500
256525	1,50 lit. / s ovzdušňovačom	1	0,583
256526	2,00 lit. / s ovzdušňovačom	1	0,583

Konva Garden



kód	popis		
254045	plast, 02 litrová	1	0,100
254302	plast, 03 litrová	1	0,150
254276	plast, 06 litrová	1	0,200
254036	plast, 08 litrová	1	0,250
254227	plast, 10 litrová	1	0,300
254161	plast, 12 litrová	1	0,350
254277	plast, 14 litrová	1	0,450

Konva

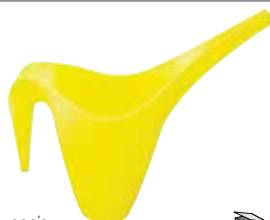

kód	popis		
254410	1800 ml	12	0,166

Tryska

STREND PRO



kód	popis		
256425	plast, DoubleImpact	1	

Tryska

STREND PRO



kód	popis		
256113	plast	1	

Rukoväť

STREND PRO



kód	popis		
256109	plast	1	

Popruh k postrekovaču

STREND PRO



kód	popis		
256093		1	

Tyč k postrekovačom

STREND PRO



kód	popis		
256078	66-96 cm, ALU, teleskopická	1	
256072	sklolaminát	1	

Tyč k postrekovačom

STREND PRO

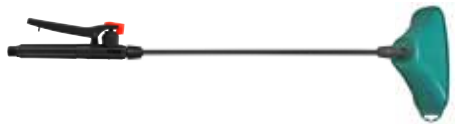

kód	popis		
256457	50-90 cm, ALU, teleskopická	1	

Tyče k postrekovačom

STREND PRO



kód	popis		
256423	plastová, teleskopická	1	

Ružica na konvu, sitko PVC



kód	popis		
211299	na 6 lit.	1	0,050
211904	na 10 lit.	1	0,060
211905	na 12-14 lit.	1	0,080

Rozstrekač na konvu



kód	popis		
256032	520mm	1	0,300

Umývadlo záhradné



kód	popis		
219761	A) 440x360x765 mm	1	36,000
219762	B) 485x420x1140 mm	1	63,000

Umývadlo záhradné



kód	popis		
219758	A) 410x210x765 mm	1	19,000
219239	B) 380x305x760 mm	1	25,000

Pumpa záhradná



kód	popis		
219763	A) pumpa / 410x160x680 mm	1	13,000
219764	B) podstavec / 240x160x680 mm	1	14,000
219765	C) filter / 1150 mm, 1-1/4"	1	4,000

Kôš sací, plastový



kód	popis		
256585	1"	250	
256586	1-1/2"	130	
256587	2"	35	

Spona na hadicu, nerez



kód	popis		
256269	8-12 mm	100	0,011
256184	10-16 mm	10	0,012
256188	12-20 mm	10	0,013
256272	16-25 mm	10	0,013
256267	20-32 mm	10	0,016
256283	25-40 mm	10	0,017
256259	30-45 mm	10	0,018
256268	32-50 mm	10	0,019
256261	40-60 mm	1	0,021
256262	50-70 mm	100	0,023
256260	60-80 mm	100	0,023
256226	70-90 mm	100	0,023
256224	80-100 mm	10	0,028

Sada spon na hadicu



kód	popis		
256342	5 dielna	40	0,067
256343	10 dielna	100	0,095

Sada spon na hadicu



kód	popis		
256453	15 dielna / 8-27 mm	25	0,120

Ventil záhradný



kód	popis		
219102	A) 1/2"	20	0,140
219103	A) 3/4"	1	0,200
219558	B) 1/2"	12	0,125
219559	B) 3/4"	12	0,183

Posúvač hadice



kód	popis		
2170476	240/55/90 mm / 3ks / CO/PP	1	0,100

Posúvač hadice

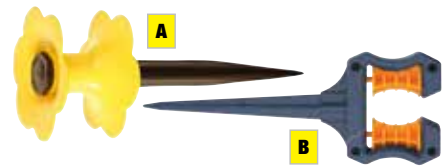

kód	popis		
2170161	A) 240/55 mm	1	0,100
256519	B) 240 mm	30	0,106

Držiak na hadicu



kód	popis		
256064	stenový	24	0,150

Držiak na hadicu



kód	popis		
256483	viazankový / PE	24	0,119

Vešiak na hadicu



kód	popis		
256486	závesný, prenosný / ABS	48	0,171

Pumpa ručná, sudová



kód	popis		
222558	vhodné aj na PHM	1	2,500

Pumpa ručná

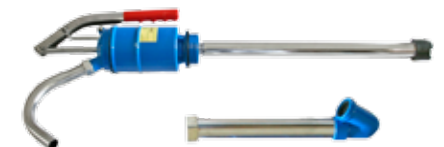

kód	popis		
212327	nehodné na PHM	8	2,750

HADICE A NAVIJÁKY / HOSE REEL

Naviják s hadicou

AQUACRAFT



kód popis

256733 1/2" / L-25 m / pištoľ + spojky 1

Možnosť upevnenia na stenu. Non-slip mäkké gumové držadlo s cieľom zabezpečiť maximálny komfort. Naklonená spojka chráni hadicu pred zamotaním a ohýbaním

Naviják s hadicou

AQUACRAFT



kód popis

256734 3/8" / L-10 m / pištoľ + spojky 1

Možnosť upevnenia na stenu. Pre terasy a malé záhrady. 7x vzor striekania.

Navijáky s hadicami



kód popis

256583 A) 50+2 m / pištoľ + spojky / 1/2" 1 11,800
256172 B) 20 m / pištoľ + spojky / 1/2" 1 4,900
256468 C) 30 m / pištoľ + spojky / 1/2" 1 7,314

Naviják na hadicu

AQUACRAFT



kód popis

256624 1/2" - 50 m, 3/4" - 30 m 1

S košom na uskladnenie náradia. Vysoká stabilita a ľahké presúvanie. Pomocný naviják predchádza deformácií, zamotaniu a ohýbaniu hadici pri stáčaní.

Naviják na hadicu

AQUACRAFT



kód popis

256623 1/2" - 60 m, 3/4" - 30 m 1

Naklonená spojka chráni hadicu pred zamotaním a ohýbaním. Vyrobené z odolnej umelej konštrukcie. Pevný oceľový rám. Rukoväť s ochranou ruky.

Naviják na hadicu

AQUACRAFT



kód popis

256622 1/2" - 45 m, 3/4" - 20 m 1

Naklonená spojka chráni hadicu pred zamotaním a ohýbaním. Vyrobené z odolnej umelej konštrukcie. Pevný oceľový rám. Rukoväť s ochranou ruky.

Naviják na hadicu, AutoMatic



kód popis

256063 L- 20m, 1/2" 1 9,000

Naviják na hadicu



kód popis

256527 40 m / 1/2" / 13 mm 1 1,000

Naviják na hadicu



kód popis

256385 A) 25 m / 1/2" 5 1,960
256384 B) 25 m / 1/2" 5 2,640

Hadica špirálová



kód popis

256398 L-15 m, rozstrekovač, spojka 15 1,270

Hadica zavlažovacia



kód popis

256549 L-15 m, hrot a filter 15 0,507

ZÁHRADA

Hadica Cellfast ECONOMIC



kód	popis		
256442	1"	20	0,320
256440	1/2"	20	0,085
256441	3/4"	20	0,160

Veľké balenia:

256473	1"	35
256470	1/2"	100
256472	3/4"	70
256471	5/8"	70

Hadica Cellfast PLUS



kód	popis		
256445	1", L-25 m	25	0,370
256443	1/2", L-25 m	25	0,130
256444	3/4", L-25 m	25	0,220

Veľké balenia:

256476	1"	30
256723	1/2"	70
256475	3/4"	60
256582	5/8"	60

Hadica Cellfast ATS2



kód	popis		
256721	1", L-25 m	25	
256720	1/2", L-25 m	25	
256480	3/4", L-25 m	25	

Veľké balenia:

256718	1"	25
256722	1/2"	60
256719	3/4"	45

Hadica Cellfast ORIGINAL FLEX



kód	popis		
256446	1/2", L-25 m	25	0,152
256447	3/4", L-25 m	25	0,252

Hadica Cellfast SPRING



kód	popis		
256466	plochá, zavlažovacia, L-7,5 m	7,5	0,650
256467	plochá, zavlažovacia, L-15 m	15	1,120

Hadica Cellfast ECOLIGHT, sada



kód	popis		
256212	1/2" L-20m, dýza, spojky	20	2,302
256215	3/4" L-20m, dýza, spojky	20	4,210

Stojan na hadice



kód	popis		
2170117			



Hadica Cellfast ATS2



NOVINKA



- Špeciálny dizajn so zosilneným pleteným polyestrom, odolný proti pokrúteniu, nenafukujúci sa
- Vyrobené z vysokokvalitných flexibilných materiálov odolných voči UV žiareniu
- Odoláva teplotám od -5°C do +65°C

kód	popis		
256770	1/2", 12,5x17 mm	25	
256771	3/4", 19x25 mm	25	
256769	1", 25x31 mm	25	

Hadica priesaková

AQUACRAFT



kód	popis		
256732	1/2" / L-7.5 m / tlak do 8 bar.	7,5	
256731	1/2" / L- 15 m / tlak do 8 bar.	15	

Na ekonomické a precízne zalievanie rastlín. Jednoduché pripojenie. Je vybavená uzatváracím ventilom.

Flexibilná hadica

AQUACRAFT



kód	popis		
256738	10-20 m; 1/2"-3/4"; tlak do 20 bar.	10	

Hadica je ľahká, praktická a robustná. Použitie všade. S pištoľou so 7 vzormi a konektormi

Hadica Aquapro FLEX



kód	popis		
256688	1", 25 mm, L-25 m	25	
256284	1/2", 12,5 mm, L-25 m	25	
256285	3/4", 19 mm, L-25 m	25	

Prevádzková teplota: -10°C + 60°C. Flexibilná hadica vyrobená z mäkkého PVC vystužená polyesterovým vláknom, čierna duša zabraňuje tvorbe rias.

Hadica ProGARDEN GC



kód	popis		
256249	13 mm, 1/2", L-25 m	25	0,112
256246	16 mm, 5/8", L-25 m	25	0,168
256247	19 mm, 3/4", L-25 m	25	0,204
256248	25 mm, 1", L-25 m	25	0,264
256257	32 mm, 1 1/4", L-20 m	20	8,517

Flexibilná hadica PREMIUM



kód	popis		
256566	10-30.4 m, 1/2"-3/4"	1	0,100
256233	5-15 m, 1/2"-3/4"	1	0,100
256265	7.5-22.5 m, 1/2"-3/4"	1	0,100

S pištoľou so 7 vzormi a konektormi

Hadica prečerpávacia, plochá



kód	popis		
256484	1", L-20 m, tlak 5 bar.	20	3,500
219056	1-1/4", L-20 m, tlak 5 bar.	20	3,900
256584	2", L-20 m, tlak 5 bar.	20	5,600

Zosilnená polyesterom. Teplota: -5°C až + 65°C.
Použitie: Zavlažovanie. Vypúšťanie kalov v poľnohospodárstve, stavebníctve, priemysle, baníctve atď.

Hadica sacia



kód	popis		
256326	1", L-30 m	30	
256735	1-1/2", L-30 m	30	
256736	2", L-30 m	30	
256737	3", L-30 m	30	

Pištoľ Premium Jet



kód	popis	kg
256639	nastaviteľná, kovové telo, 3x vzor	12

Nastaviteľná prietoková rýchlosť. Ergonomický predný spúšťač s praktickým zámkom. Kovový adaptér pre vysokú odolnosť voči nárazom

Pištoľ Premium Jet



kód	popis	kg
256643	nastaviteľná, 3x vzor	12

Plastová konštrukcia vysoko odolná proti nárazom. 3 úrovne nastavenia postreku s protišmykovým gumovým okrajom pre ľahké uchopenie. Ergonomický predný spúšťač s praktickým zámkom

Pištoľ Premium X5



kód	popis	kg
256641	nastaviteľná, 5x vzor	12

Plastová konštrukcia vysoko odolná proti nárazom. 5 úrovní nastavenia postreku s protišmykovým gumovým okrajom pre ľahké uchopenie. Ergonomický predný spúšťač s praktickým zámkom

Pištoľ Premium X5



kód	popis	kg
256637	nastaviteľná, 5x vzor, kovové telo	12

Nastaviteľná prietoková rýchlosť. Ergonomický predný spúšťač s praktickým zámkom. Kovový adaptér pre vysokú odolnosť voči nárazom

Pištoľ Ergonomic X4



kód	popis	kg
256638	nastaviteľná, kovové telo, 4x vzor	12

Kovová konštrukcia potiahnutá mäkkou gumou pre komfortné použitie. Regulátor prietoku vody s protišmykovým gumovým okrajom pre ľahké uchopenie a možnosťou vypnutia/zapnutia. Kovový adaptér pre vysokú odolnosť voči nárazom

Pištoľ Ergonomic X4



kód	popis	kg
256642	nastaviteľná, 4x vzor	12

Plastová konštrukcia vysoko odolná proti nárazom potiahnutá mäkkou gumou pre komfortné použitie. Regulátor prietoku vody s protišmykovým gumovým okrajom pre ľahké uchopenie a možnosťou vypnutia/zapnutia

Pištoľ Ergonomic Jet



kód	popis	kg
256640	nastaviteľná, kovové telo, 2x vzor	12

Kovová konštrukcia potiahnutá mäkkou gumou pre komfortné použitie. Regulátor prietoku vody s protišmykovým gumovým okrajom pre ľahké uchopenie a možnosťou vypnutia/zapnutia. Mosadzné ukončenie na prispôbienie prúdu vody z jemného prúdu do rozprašovania. Kovový adaptér pre vysokú odolnosť voči nárazom

Pištoľ Ergonomic Jet / Classic X3



kód	popis	kg
256644	A) nastaviteľná, 2x vzor	12

Plastová konštrukcia vysoko odolná proti nárazom potiahnutá mäkkou gumou pre komfortné použitie. Regulátor prietoku vody s protišmykovým gumovým okrajom pre ľahké uchopenie a možnosťou vypnutia/zapnutia

256090	B)	12
--------	----	----

Plynule prispôbienie prúdu vody z jemného prúdu do rozprašovania.

Pištoľ Classic Jet X2



kód	popis	kg
256635	nastaviteľná, 2x vzor	12

Plastová konštrukcia vysoko odolná proti nárazom potiahnutá mäkkou gumou pre komfortné použitie. 3 úrovne nastavenia postreku s protišmykovým gumovým okrajom pre ľahké uchopenie. Ergonomické uchopenie pre extra komfortné a ľahké používanie. Nastaviteľná prietoková rýchlosť

Pištoľ Comfort Jet

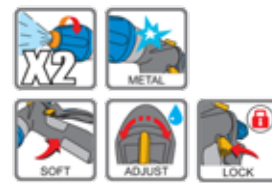

kód	popis	kg
256633	nastaviteľná, kovové telo, 2x vzor	12

Kovová konštrukcia potiahnutá mäkkou gumou pre komfortné použitie. 3 úrovne nastavenia postreku s protišmykovým gumovým okrajom pre ľahké uchopenie. Mosadzné ukončenie na prispôbienie prúdu vody z jemného prúdu do rozprašovania. Ergonomické uchopenie pre extra komfortné a ľahké používanie. Nastaviteľná prietoková rýchlosť.

Pištoľ Classic X4



kód	popis	kg
256676	nastaviteľná, 4x vzor	12

Plastová konštrukcia vysoko odolná proti nárazom potiahnutá mäkkou gumou pre komfortné použitie. 4 úrovne nastavenia postreku s protišmykovým gumovým okrajom pre ľahké uchopenie. Ergonomické uchopenie pre extra komfortné a ľahké používanie. Nastaviteľná prietoková rýchlosť

Pištoľ Comfort X4

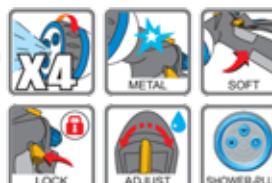

kód	popis	kg
256631	nastaviteľná, kovové telo, 4x vzor	12

Kovová konštrukcia potiahnutá mäkkou gumou pre komfortné použitie. 4 úrovne nastavenia postreku s protišmykovým gumovým okrajom pre ľahké uchopenie. Ergonomické uchopenie pre extra komfortné a ľahké používanie. Nastaviteľná prietoková rýchlosť.

Pišťoľ striekacia



kód	popis		
256588	kovové telo		

Pišťoľ striekacia



kód	popis		
256589	kovové telo, nastaviteľná, 7x vzor		

Pišťoľ striekacia



kód	popis		
256546	nastaviteľná		0,250

Pišťoľ striekacia



kód	popis		
256530	5x vzor	6	0,354

Pišťoľ striekacia



kód	popis		
256529	2+8 vzor	6	0,416

Pišťoľ striekacia



kód	popis		
256488	A) kovové telo	20	0,311
256489	B) kovové telo	40	0,285

Pišťoľ striekacia



kód	popis		
256487	plastové	1	0,210

Pišťoľ striekacia



kód	popis		
256495	7 vzorov / PVC	40	0,325
256496	8 vzorov / PVC	20	0,220

Pišťoľ striekacia



kód	popis		
256490	8 vzorov / PVC	40	0,313

Pišťoľ striekacia



kód	popis		
256491	nastaviteľná	1	0,081

Pišťoľ striekacia



kód	popis		
256192	A) 06 vzorov, nastaviteľná	48	0,140
256388	A) 10 vzorov, nastaviteľná	48	0,190
256264	B) 06 vzorov, nastaviteľná	36	0,483
256106	B) 10 vzorov, nastaviteľná	36	0,466

Pišťoľ striekacia



kód	popis		
256199	A) nastaviteľná	48	0,150
256239	B) nastaviteľná	24	0,650

Pišťoľ striekacia



kód	popis		
256386	A) nastaviteľná	1	0,208
256387	B) 8 vzorov	1	0,233

Pišťoľ striekacia

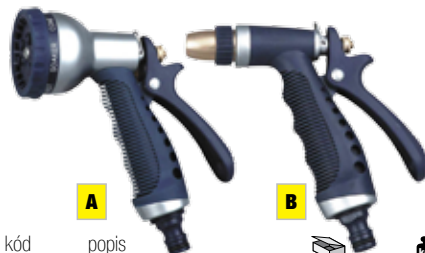

kód	popis		
256240	A) 7 vzorov, nastaviteľná, Alu	48	0,330
256379	B) nastaviteľná	48	0,144

Pišťoľ striekacia



kód	popis		
256389	A) 7 vzorov, nastaviteľná	48	0,173
256200	B) vzor sprcha, nastaviteľná	48	0,133

Sada zavlažovacia

AQUACRAFT



kód	popis	kg
256636	spojka 1/2", spojka STOP 1/2" adaptér 1/2"-3/4"-1" pištoľ Comfort 2x vzor	6

Sada zavlažovacia

AQUACRAFT



kód	popis	kg
256632	spojka 1/2", spojka STOP 1/2" adaptér 1/2"-3/4"-1" pištoľ Classic 4x vzor	6

Sada zavlažovacia

AQUACRAFT



kód	popis	kg
256610	spojka 1/2", spojka STOP 1/2" adaptér 1/2"-3/4" dýza nastaviteľná	12

Dýza zavlažovacia

AQUACRAFT



kód	popis	kg
256609	nastaviteľná, 2x vzor	20

Vysoko kvalitná dýza s moderným dizajnom a odolnou konštrukciou. Hlavica pokrytá protišmykovou ochrannou gumou pre jednoduchú manipuláciu. Plynule nastaviteľný prechod z rosenia po intenzívny prúd

Dýza Premium Jet

AQUACRAFT

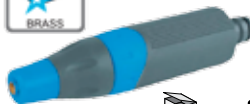

kód	popis	kg
256612	nastaviteľná, 2x vzor, dýza mosadz	12

Ergonomická rukoväť s gumovým krytom pre komfortné použitie. Plynule nastaviteľný prechod z rosenia po intenzívny prúd. Hlavica pokrytá protišmykovou ochrannou gumou pre jednoduchú manipuláciu

Dýza Premium X3

AQUACRAFT



kód	popis	kg
256611	nastaviteľná, 3x vzor, dýza mosadz	12

Ergonomická rukoväť s gumovým krytom pre komfortné použitie. Plynule nastaviteľný prechod z rosenia po intenzívny prúd. Hlavica pokrytá protišmykovou ochrannou gumou pre jednoduchú manipuláciu.

Rozprašovač Premium X2

AQUACRAFT



kód	popis	kg
256645	nastaviteľná, 2x vzor, 90 cm	6

2 úrovne nastavenia postreku s protišmykovým gumovým okrajom pre ľahké uchopenie. Nastaviteľný prietok vody. Ergonomické uchopenie pre extra komfortné a ľahké používanie. Ideálne na zavlažovanie ťažko prístupných oblastí ako sú napr. kvetinové záhony, vázy a závesné kvetnáče...

Dýza zavlažovacia

AQUACRAFT



kód	popis	kg
256663	3/4"	12
256664	1"	12

Dýza striekacia



kód	popis	kg
256304	1", na hadicu	1, 0,100

Dýza striekacia



kód	popis	kg
256590	nastaviteľná, 2x vzor, kovové telo	12

Sada spojok



kód	popis	kg
256591	nastaviteľná, 2x vzor, 1/2", 3/4"	12
256592	nastaviteľná, 2x vzor, 3/4", 1"	12

Dýza na hadicu



kód	popis	kg
256567	3/4", mosadzná	1

Dýza na hadicu



kód	popis	kg
256497	plastová	200, 0,065

Dýza na hadicu



kód	popis	kg
256238	plastová	200, 0,065

Rozprašovač, sprcha



kód	popis	kg
256396	70 cm	12, 0,340

Sprcha záhradná, teleskopická



kód	popis	kg
256397	165-240 cm	6, 1,280

Časovač na vodu



kód	popis	kg
256556	A) dĺžka časovača až 120 min	1, 0,250
256545	B) dĺžka časovača až 120 min	1, 0,254

Pišťoľ striekacia



kód	popis		
256517	2x spojka / 1x adaptér / 7 vzorov	1	0,317

Pišťoľ striekacia



kód	popis		
256511	2x spojka / 1x adaptér	1	0,367

Pišťoľ striekacia



kód	popis		
256512	2x spojka / 1x adaptér	1	0,281

Pišťoľ striekacia



kód	popis		
256514	1x spojka	1	0,299

Pišťoľ striekacia



kód	popis		
256513	1x spojka	1	0,333

Pišťoľ striekacia



kód	popis		
256391	6 vzorov + spojka	48	0,200

Sada pištoľ



kód	popis		
256374	dýza + sada spojok	24	0,500

Sada pištoľ



kód	popis		
256372	7 vzorov + sada spojok	24	0,540

Pišťoľ striekacia



kód	popis		
256193	6 vzorov + sada spojok	48	0,280

Pišťoľ striekacia



kód	popis		
256250	nastaviteľná, sada spojok	48	0,220

Pišťoľ striekacia



kód	popis		
256390	so spojkou	48	0,180

Pišťoľ striekacia SoftFace



kód	popis		
256547	1/2", pištoľ, adaptér a spojky	1	0,131

Sada spojok



kód	popis		
256508	1/2", 5 dielna	1	0,144
256509	3/4", 5 dielna	1	0,172

Sada spojok na hadicu



kód	popis		
256402	DY8021 • spojka 3/4" a 1"	48	0,160
256187	DY8025 • spojka 1/2" a 3/4"	48	0,140

Sada spojok SoftFace



kód	popis		
256548	3/4", dýza, adaptér a spojky	1	0,131

Rozprašovač stacionárny AQUACRAFT



kód popis

256629 8 rozprašovacích vzorov

8 úrovni postreku. Ľahká plastová základňa garantuje stabilitu. Z odolného plastového materiálu pre dlhú životnosť.

Rozprašovač rotačný AQUACRAFT



kód popis

256626 3x rozprašovač

3 ramená zabezpečujú kruhové zavlažovanie. Ľahká plastová základňa garantuje stabilitu. Možnosť pripojenia viacerých rozprašovačov pre zavlažovanie veľkých plôch. Z odolného plastového materiálu pre dlhú životnosť.

Rozprašovač rotačný AQUACRAFT

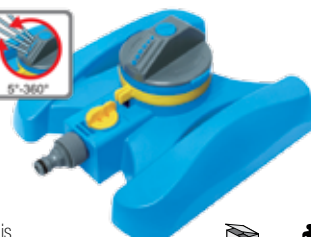

kód popis

256625 2 rozprašovacie dýzy, uhol 5°-360°

Nehlučná prevádzka so záberom 360 stupňov pre zavlažovanie malých a veľkých záhrad. Pevná základňa garantuje stabilné zavlažovanie a tiež mobilitu. Nastaviteľná prietoková rýchlosť a dosah postreku. Maximálny priemer zavlažovania: do 24 m

Rozprašovač rotačný AQUACRAFT



kód popis

211656 A) 5x vzor, uhol 5°-360°, 315 m²

256648 B) 5x vzor, uhol 5°-360°, 315 m²

Nehlučná prevádzka so záberom 360 stupňov pre zavlažovanie malých a veľkých záhrad. 5 úrovni postreku pre všetky formy zavlažovania. Tlačidlo umožňuje postrek v rozsahu čiastočného okruhu až po celý okruh. S kovovým hrotom alebo odolnou spodnou časťou. Maximálny rozsah zavlažovania: 315 m²

Rozprašovač rotačný AQUACRAFT

A



B

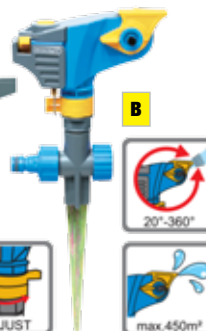

kód popis

256628 A) 3x rozprašovač 12

Vyrobené z pevného plastu. 3 ramená zabezpečujú kruhové zavlažovanie. Plastový hrot na bezpečné zaistenie do trávniky

256630 B) uhol 20°-360°, max. 450m² 6

Umožňuje postrek v rozsahu čiastočného okruhu až po celý okruh. Možnosť pripojenia viacerých rozprašovačov pre zavlažovanie veľkých plôch. Otačanie o 20 až 360 stupňov.

Rozprašovač oscilačný AQUACRAFT



kód popis

256627 18x vzor, max. 360 m²

Nastaviteľná prietoková rýchlosť a dosah postreku. Vysoko kvalitná plastová základňa zabraňuje prevráteniu.

Rozprašovač oscilačný AQUACRAFT

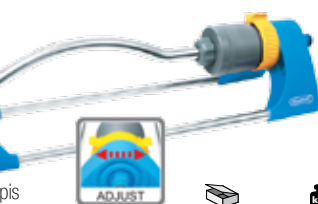

kód popis

256647 15x dýza, max. 180 m²

15 trysiek vyrobených z trvácneho a odľahčeného hliníka. Pre ešte lepšie zavlažovanie trávniky.

Rozprašovač oscilačný AQUACRAFT



kód popis

256649 18x dýza, max. 300 m²

18 trysiek z plastu. Pre ešte lepšie zavlažovanie trávniky.

Rozprašovač oscilačný AQUACRAFT



kód popis

211754 18x dýza, max. 340 m²

18 trysiek so 6 spínačmi pre nastavenie šírky pokrytia. Nastaviteľná prietoková rýchlosť. Možnosť prispôsobenia rozsahu postreku.

Rozprašovač stacionárny



kód popis

256493 A) 8 vzorov / PVC 10 0,332

256518 B) 5 vzorov / PVC 10 0,272

Rozprašovač stacionárny



kód popis

256492 A) 3-ramenný / PVC 10 0,508

256069 B) 3-ramenný / PVC 24 0,470

Rozprašovač stacionárny



kód popis

256067 a) 36 0,471

256395 b) Ms 6 0,710

Rozprašovač impulzný



kód popis

256494 Zn / PVC 1 0,370

Rozprašovač 210m², 20x tryska

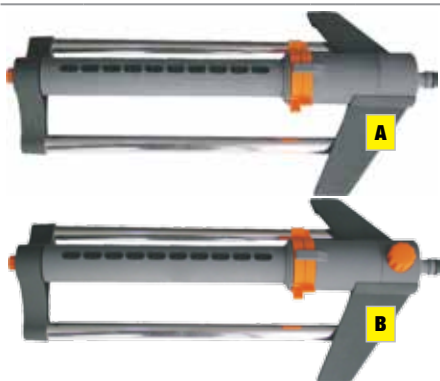

kód	popis		
256523	A) 4x vzor rozprašovania	1	0,416
256522	B) 4x vzor + nastaviteľný ventil	1	0,441

Rozprašovač 300m², 24x tryska



kód	popis		
256521	4x vzor rozprašovania	1	0,791

Rozprašovač 150m², 19x tryska



kód	popis		
256528	3v1 / 3x vzor rozprašovania	1	

Rozprašovač rotačný



kód	popis		
256066	18 trysiek	1	0,730

Rozprašovač stacionárny



kód	popis		
256394	A) 8 vzorov	48	0,230
256068	B) 8 vzorov	48	0,175

Rozprašovač hrotový STREND PRO®



kód	popis		
256563	2 vzory / nastaviteľný / 26m ²	1	0,157

Rozprašovač impulzný



kód	popis		
256197	A) plastový	50	0,096
256198	B) mosadzný	50	0,217

Rozprašovač impulzný

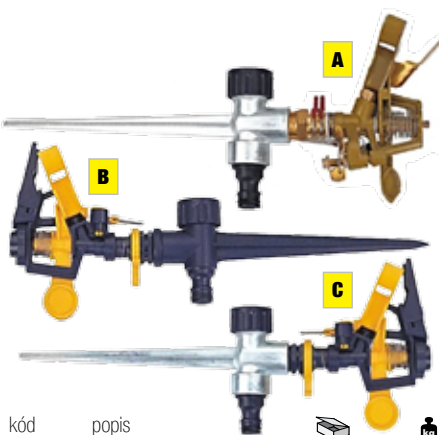

kód	popis		
256070	A) Zn	25	0,312
256194	B) plastový	30	0,105
256196	C) Plast-Zn	25	0,157

Rozprašovač stacionárny

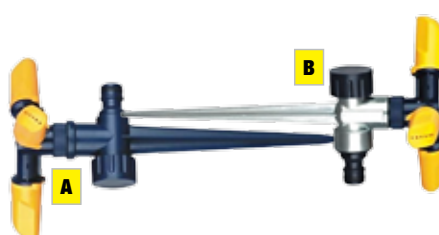

kód	popis		
256392	A) rotačný	48	0,115
256393	B) rotačný / Zn	36	0,131

Hrot pre zavlažovač

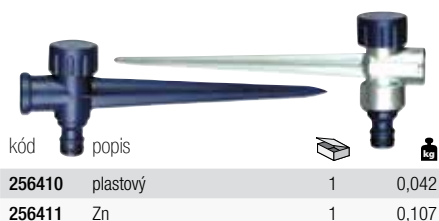

kód	popis		
256410	plastový	1	0,042
256411	Zn	1	0,107

Sada zavlažovacia



kód	popis		
256568	hadica 20m, Ø 13 mm, 33 dielna	1	0,038

Rozprašovač stojanový, impulzný

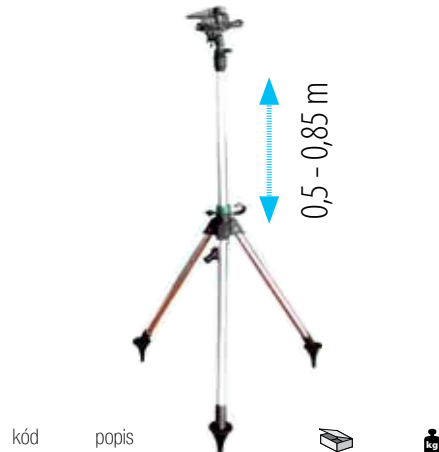

kód	popis		
256433	0.5-0.85 m, plastový	10	0,636

Rozprašovač stojanový, impulzný

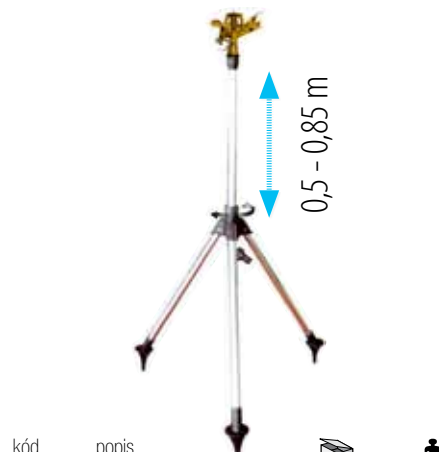

kód	popis		
256434	0.5-0.85 m, mosadzný	10	0,800

Merač dažďových zrážok



kód	popis		
217953	A) 80 cm, so stojanom	1	
217837	B) 24 cm, nádržka	1	

Spojka hadicová, pogumovaná



kód	popis	ks
256201	A) 1/2", 13 mm	20
256202	B) 1/2", 13 mm, funkcia STOP	20

Vysoko kvalitná spojka s moderným dizajnom a odolnou konštrukciou. Mäkká upínacia hlavica s gumovým krytom pre komfortné použitie. S protišmykovým ergonomickým dizajnom pre jednoduchú manipuláciu.

Spojka hadicová, pogumovaná



kód	popis	ks
256141	A) 5/8"-3/4", 16-19 mm	20
256142	B) 5/8"-3/4", 16-19 mm, funkcia STOP	20

Vysoko kvalitná spojka s moderným dizajnom a odolnou konštrukciou. Mäkká upínacia matica s gumovým krytom pre komfortné použitie. S protišmykovým ergonomickým dizajnom pre jednoduchú manipuláciu.

Spojka hadicová, pogumovaná



kód	popis	ks
256145	A) 1/2", 13 mm	20
256148	B) 5/8"-3/4", 16-19 mm	20

Vysoko kvalitná spojka pre opravu poškodenej hadice alebo spojenie dvoch hadíc s moderným dizajnom a odolnou konštrukciou. Mäkká upínacia hlavica s gumovým krytom pre komfortné použitie

Spojky



kód	popis	ks
256651	A) spojka hadicová / 3/4"	
256653	B) spojka hadicová / 1"	
256652	C) redukcia / 3/4"	
256654	D) redukcia / 3/4"-1"	

Spojka hadicová



kód	popis	ks
256650	1"	

Spojka s ventilom

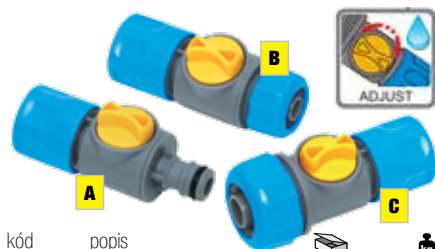

kód	popis	ks
256618	A)	12
256619	B) 1/2", 13 mm	12
256620	C) 5/8"-3/4", 16-19 mm	12

Na regulovanie alebo zastavenie prietoku vody v hadici. Vhodné pre takmer všetky rozprašovače. Jednoduché uvoľnenie spojenia

Adaptér hadicový, pogumovaný



kód	popis	ks
256153	A) 1/2", dvojnývodová spojovací medzikus pre 2 spojky	36
256604	B) 1/2", trojnývodová spojovací medzikus pre 3 spojky	20

Vysoko kvalitná spojka na spájanie troch hadíc s moderným dizajnom a odolnou konštrukciou. S protišmykovým gumovým povrchom pre jednoduchú manipuláciu.

Adaptér na hadicu



kód	popis	ks
256615	A)	12
256616	B) 1/2", 13 mm	12
256617	C) 3/4"-5/8", 16-19 mm	12

Zabraňuje zalomeniu a pretáčaniu hadice na kohútiku spôsobeným krútením a točením

Adaptér hadicový



kód	popis	ks
256655	A) 3/4"-1"	
256656	B) 1"	

Adaptér na hadicu



kód	popis	ks
256657	A) 3/4"	
256658	B) 3/4"-1"	

Adaptér na hadicu, pogumovaný

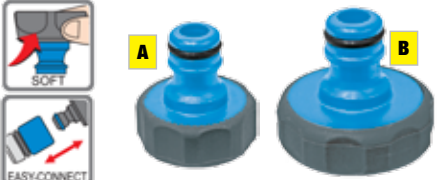

kód	popis	ks
256605	A) 3/4", 26.5 mm	20
256606	B) 1", 33.1 mm	20

Vysoko kvalitný adaptér s moderným dizajnom a odolnou konštrukciou. S protišmykovým gumovým povrchom pre jednoduchú manipuláciu. Vnútorňový závit. Pripájanie na koniec hadice

Adaptér na hadicu, pogumovaný

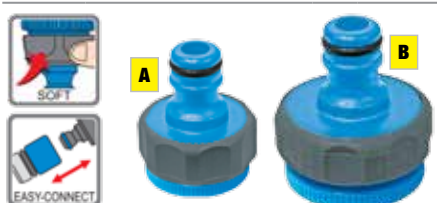

kód	popis	ks
256607	A) 3/4"-1/2", 21-26.5 mm	
256608	B) 1"-3/4", 26.5-33.1 mm	

Vysoko kvalitný adaptér s moderným dizajnom a odolnou konštrukciou. S protišmykovým gumovým povrchom pre jednoduchú manipuláciu. Vnútorňový závit. Pripájanie na koniec hadice

Adaptér na hadicu



kód	popis	ks
256659	A) 3/4"-3/4"x1"	
256677	B) 1"-3/4"x1"	

Rozbočovač Premium



kód	popis	ks
256613	3/4"-1", 26.5-33.1 mm	12

Dve samostatné nastaviteľné spojky na hadicu alebo časovač. Obe spojky môžu byť použité súčasne. Potiahnutý mäkkou protišmykovou gumou pre komfortné použitie

Rozbočovač Premium



kód	popis	ks
256614	3/4"-1", 26.5-33.1 mm	12

Štyri samostatné nastaviteľné spojky na hadicu alebo časovač. Všetky spojky môžu byť použité súčasne. Potiahnutý mäkkou protišmykovou gumou pre komfortné použitie

ADAPTERS

Časovač na zavlažovanie **AQUACRAFT**



kód	popis	ks	kg
256621	3/4"-1", 26.5-33.1 mm	6	

LCD displej. Zariadenie informuje o nízkej hladine baterie, možnosti nabijania, nastavenia dvoch individuálnych cyklov zavlažovania za deň, trvanie polievacích intervalov od 1 minúty po 99 minút, možnosť týždňových dlhodobých programov s individuálnymi nastaveniami jednotlivých dní v týždni. 9V batériové napájanie (nie je zahrnuté). 7-dňový program. 2-časová závlaha.

Časovač na zavlažovanie



kód	popis	ks	kg
256557	Zavlažovanie 1 minúta až 24 hodín	1	0,438

LCD displej / 4-krát zavlažovanie za deň
Možnosť nastavenia dňa zavlažovania
Možnosť opakovania programu týždenne / 4ks AA batérií

Spojka hadicová - rýchlospojka



kód	popis	ks	kg
256270	A) DY8029 • 3/4"	250	0,045
256111	A) DY8030 • 3/4" STOP	250	0,046
256049	B) DY8010 • 1/2"	250	0,035
256091	B) DY8011 • 1/2" STOP	250	0,036

Adaptér na hadicu



kód	popis	ks	kg
256506	A) TS3037 • 1/2"	24	0,016
256406	A) DY8017 • 3/4"	250	0,019
256408	A) DY8028 • 1"	250	0,025
256660	B) DY8023 • 3/4" - 1"	240	0,031
256110	B) DY8024 • 1/2" - 3/4"	240	0,024

Spojka na hadicu, Softface



kód	popis	ks	kg
256116	1/2-5/8", fľefibilná	24	0,067

Spojka



kód	popis	ks	kg
256504	A) hadicová	250	0,035
256505	B) 1/2"	250	0,041

Adaptér



kód	popis	ks	kg
256500	A) TAP	1	0,038
256501	B) 3/4"	1	0,008

Spojka



kód	popis	ks	kg
256515	A) Recoil	250	0,039
256516	B) TAP	1	0,090

Spojka hadicová



kód	popis	ks	kg
256075	DY8013 • 3/4"	250	0,034
256076	DY8014 • 1/2"	250	0,029

Redukcia



kód	popis	ks	kg
256503	3/4" - 1/2"	250	0,022
256502	1" - 1/2"	1	0,019

Spojka



kód	popis	ks	kg
256399	A) rozbočovač 2way	12	0,153
256507	B) s ventilom	1	0,050

Adaptér



kód	popis	ks	kg
256499	uzatvárací ventil	1	0,047

Spojka



kód	popis	ks	kg
256401	1 cestná	240	0,042
256400	2 cestná	240	0,104

Adaptér



kód	popis	ks	kg
256403	A) Snap-In / 1/2"	48	0,087
256404	B) 3way / 3x rýchlospojka	100	0,032

Adaptér



kód	popis	ks	kg
256407	3/4"	240	0,015
256405	2way	250	0,021

Adaptér mosadzný



kód	popis	ks	kg
256542	1", vnútorný závit	1	
256541	3/4"-1/2", vnútorný závit	1	
256543	1"-3/4", vnútorný závit	1	

Spojka mosadzná



kód	popis	ks	kg
256535	A) 1/2"	1	
256536	A) 1/2" STOP	1	
256537	B) 3/4"	1	
256538	B) 3/4" STOP	1	
256539	C) 1/2"	1	
256540	C) 3/4"	1	

Adaptér mosadzný



kód	popis	ks	kg
256544	A) 3/4", vonkajší závit	1	
256662	B) 3/4", medzikus pre 2 rýchlospojky	1	

Spojka GEKA



NOVINKA

kód	popis
219367	1/4"x32 mm
219626	1"x25 mm
219328	12"x13 mm
219381	3/4"x20 mm
219378	5/8"x16 mm

Spojka GEKA



NOVINKA

kód	popis
219015	1/4"x32 mm
219359	1"x25 mm
219436	12"x13 mm
219394	3/4"x20 mm
219366	5/8"x16 mm

Rozvodka GEKA



NOVINKA

kód	popis
219179	

Adaptér GEKA



NOVINKA

kód	popis
219181	

Adaptér GEKA



NOVINKA

kód	popis
219040	1/4"
219042	1"
219029	1/2"
219016	3/4"

Spojka GEKA



NOVINKA

kód	popis
219252	1/4", závit
219251	1", závit
219238	1/2", závit
219260	3/4", závit

Tesnenie GEKA



NOVINKA

kód	popis
219542	1/4", gumové, pre 219252
219013	1", gumové, pre 219251
219041	1/2", gumové, pre 219238
219014	3/4", gumové, pre 219260

Tesnenie GEKA



NOVINKA

kód	popis
256650	gumové, pre všetky spojky

Manometer



NOVINKA

kód	popis
219413	1/4"

Manometer



NOVINKA

kód	popis
219410	Ø 80 mm



Hrabličky na lístie

AQUACRAFT



- na hrabanie lístia a trávy
- vyrobené z vysoko kvalitného kovu
- nalakované

kód	popis		
211940	9 lamiel, 40 cm	12	

Hrabličky do pôdy

AQUACRAFT



- na hrabanie, vyrovnávanie záhonov a obrábanie pôdy
- vyrobené z vysoko kvalitného kovu
- nalakované

kód	popis		
211939	4 zubé, 29 cm	12	

Motyčka 2v1

AQUACRAFT



- na kyprenie pôdy
- vyrobené z vysoko kvalitného kovu
- nalakované

kód	popis		
211941	motyčka + 3 zubá, 29,3 cm	12	

Lopatka

AQUACRAFT



kód	popis		
211937	úзка, sadenicová, 30,5 cm	12	
211936	široká, sadenicová, 30,5 cm	12	

Do kamenitej, ílovitej a tvrdej pôdy. Vyrobené z vysoko kvalitného kovu. Nalakované

Vypichovač

AQUACRAFT



kód	popis		
211942	na burinu, 31,5 cm	12	

Na odstránenie trávy a buriny zo škrá medzi doskami a v okolí múrov. Vyrobené z vysoko kvalitného kovu. Nalakované

Kyprič do pôdy

AQUACRAFT



kód	popis		
211938	3-hrotý, 30,4 cm		

Na kyprenie pôdy s cieľom zabezpečiť prístup živín. Vyrobené z vysoko kvalitného kovu. Nalakované

Kyprič do pôdy

AQUACRAFT



kód	popis		
211934	3-hrotý, 139,5 cm	12	

Na kyprenie a prevzdušňovanie pôdy bez poškodenia koreňov rastlín. Vyrobené z vysoko kvalitnej ocele, odolné proti korózii. Pevná ocelová protišmyková rukoväť pre extra komfortné a ľahké používanie

Motyčka záhradná

AQUACRAFT



kód	popis		
211935	plochá, 136,7 cm	12	

Na okopávanie a kyprenie pôdy. Vyrobené z vysoko kvalitnej ocele, odolné proti korózii. Pevná ocelová protišmyková rukoväť pre extra komfortné a ľahké používanie.

Motyčka plochá, TeleScope105



teleskopická rukoväť

kód	popis		
2110029	3-hrotá, 18x118 cm	20	0,810

Motyčka špicatá, TeleScope105



teleskopická rukoväť

kód	popis		
2110030	2-hrotá, 18x114 cm	20	0,800

Hrabličky



teleskopická rukoväť

kód	popis		
2110028	5 zubé, 9x7x78-120 cm	20	0,670

Kyprič, TeleScope105



teleskopická rukoväť

kód	popis		
2110027	3-hrotý, 74x118 cm	12	0,705

Hrabličky



kód	popis		
2110179	7 lamiel, 9,5x53 cm	50	0,309

Hrabličky



kód	popis		
2110180	5-zubé, 8,5x41 cm	40	0,265

Kyprič



kód	popis		
2110181	3-hrotý, 6x8x30 cm	1	0,273

Motyčka špicatá



kód	popis		
2110152	dvojzubá, 19x41 cm	40	0,316

Motyčka



kód	popis		
2110183	plochá, 3-hrotá, 19x41 cm	1	0,370

Lopatka sadenicová



kód	popis		
2110182	16x7x43 cm	1	0,274

Lopatka široká, sadenicová



teleskopická rukoväť

kód	popis		
2110032	18x10x66 cm	20	0,700

Hrabličky



kód	popis		
211921	10 zubé, 180x482 mm	1	0,100

Hrabličky



kód	popis		
211922	8 zubé, 165x420 mm	1	0,100

Rýľ



kód	popis		
211919	118x500 mm	1	0,104

Lopatka sadenicová



kód	popis		
211920	137x475 mm	1	0,108

Lopatka rovná, sadenicová



kód	popis		
211924	105x510 mm	1	0,112

Motyčka sadenicová



kód	popis		
211923	60x137x385 mm	1	0,088

Kultivátor záhradný

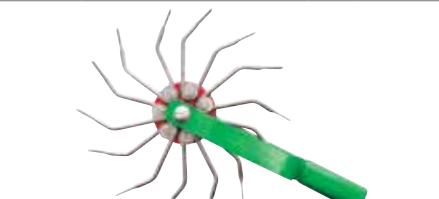

kód	popis		
211642	bez násady, 24x35 cm	1	1,500

Kyprič záhradný



kód	popis		
2110206	3-hrotý, 26 cm	50	0,180

Kyprič 3 hrotý



kód	popis		
2110153	kovový, 31 cm	50	0,238
2110186	kovový s násadou	1	0,450

Kyprič 3 hrotý



kód	EAN	popis		
211310	006	bez násady, 7x16 cm	1	0,070
211337	006/250	s násadou 250 mm	1	0,150
211091	106	bez násady, 10x20 cm	1	0,180
211340	106/550	s násadou 550 mm	1	0,350
211342	106/100	s násadou 1000 mm	1	0,480

Kyprič ručný



kód	popis		
211865	jednoradový, 33x11.5 cm	20	0,330

Kultivátor



kód	popis		
211640	s plečkou, 24x13.5 cm	12	0,650

Prevzdušňovač kovový



kód	popis		
2110205	5-radový, 30 cm	1	1,080

Prevzdušňovač

STREND PRO
PREMIUM



kód	popis		
2110257	11 nožov, 40.5x145 cm teleskopický	1	

Prevzdušňovač 4-radový

STREND PRO
PREMIUM



kód	popis		
2110258	4 nože, 150 mm, teleskopický	1	

Prevzdušňovač s násadou



kód	popis		
2110207	141 cm	10	1,200

Kultivátor 3-radový, s násadou

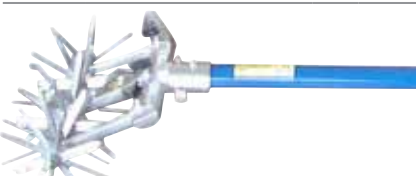



kód	popis		
2110210	141 cm	8	1,000

Kultivátor záhradný



kód	popis		
2110043	18x23 cm	50	0,300



Lopatka sadenictová

	kód	popis		
2110020	široká, 70x330 mm	50	0,206	

Lopatka sadenictová

	kód	popis		
2110021	úžká, 65x350 mm	100	0,167	

Motyčka špicatá

	kód	popis		
2110024	2 zubá, 190x320 mm	60	0,203	

Motyčka plochá

	kód	popis		
2110023	3 zubá, 190x320 mm	60	0,264	

Vidlička

	kód	popis		
2110025	3 zubá, 80x300 mm	1	0,300	



Kyprič

	kód	popis		
2110026	3-hrotý, 75x415 mm	50	0,080	



Kyprič drôtený

	kód	popis		
2110022	7 lamiel, 90x440 mm	25	0,212	

Lopatka sadenictová, plastová

	kód	popis		
2110111	široká, 80x280 mm	36	0,109	

Lopatka sadenictová, plastová

	kód	popis		
2110112	úžká, 60x290 mm	36	0,098	



Vidlička sadenictová, plastová

	kód	popis		
2110113	3 zubá, 70x260 mm	1	0,300	

Kyprič sadenictový, plastový

	kód	popis		
2110114	80x275 mm	1	0,300	

Lopatka sadenictová, kovová

	kód	popis		
2110204	široká, 90x300 mm	100	0,180	

Lopatka sadenictová, kovová

	kód	popis		
2110202	úžká, 60x290 mm	100	0,150	

Kyprič záhradný, kovový

	kód	popis		
2110203	5x hrot, 85x300 mm	100	0,160	



Hrabličky

	kód	popis		
211554	5 zubé, 110x315 mm	48	0,270	

Motyčka plochá

	kód	popis		
211553	3-hrotá, 80x315 mm	50	0,311	

Motyčka špicatá

	kód	popis		
211572	2-hrotá, 80x310 mm	60	0,261	

Kyprič

	kód	popis		
2110184	3-zubý, 80x410 mm	1	0,220	

Kyprič na zemnu, úzky

	kód	popis		
211129	430 mm	50	0,240	

Vypichovač na burinu

	kód	popis		
211158	345 mm	50	0,208	

Nôž na burinu

	kód	popis		
211090	250 mm	1	0,072	

Nôž na burinu

	kód	popis		
211216	250 mm	100	0,090	

Motyčka

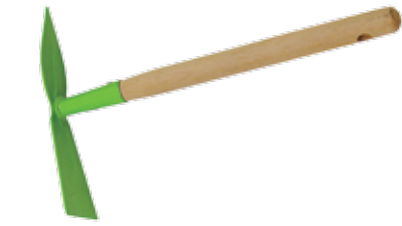

kód	popis		
211791	plochá/špicatá, 55x275 mm	1	0,160

Motyčka



kód	popis		
211184	plochá, 90x410 mm	1	0,160

Hrabličky



kód	popis		
211792	5 zubé, 85x275 mm	1	0,160

Kyprič záhradný



kód	popis		
211793	3 hrotý, 70x350 mm	1	0,160

Hrabličky 6 zubé



kód	EAN	popis		
211409	109	bez násady, 95x145 mm	1	0,180
211740	109/250	s násadou 250 mm	1	0,250
211639	109/550	s násadou 550 mm	1	0,350
211014	109/1000	s násadou 1000 mm	1	0,480

Motyčka špicatá



kód	popis		
2110096	bez násady, 60x70 mm	40	0,160
2110097	2 hrotá / 250 mm násada	25	0,250
2110102	2 hrotá / bez násady	40	0,220
2110101	2 hrotá / 550 mm násada	10	0,380
2110100	2 hrotá / 1000 mm násada	10	0,520
2110088	3 hrotá / 0250 mm násada	25	0,350
2110098	3 hrotá / 0550 mm násada	10	0,390
2110099	3 hrotá / 1000 mm násada	10	0,550

Motyčka plochá, 3 hrotá



kód	EAN	popis		
211237	002	bez násady, 150x60 mm	1	0,110
211339	002/250	s násadou 250 mm	1	0,190

Motyčka plochá, 2 hrotá



kód	EAN	popis		
211303	003	bez násady, 155x60 mm	1	0,100
211304	003/250	s násadou 250 mm	1	0,180

Motyčka plochá, špicatá



kód	EAN	popis		
211225	001	bez násady, 175x60 mm	1	0,100
211226	001/250	s násadou 250 mm	1	0,180

Motyčka plochá



kód	EAN	popis		
211029	108	bez násady, 180x115mm	1	0,170
211627	108/550	s násadou 550 mm	1	0,340
211176	108/1000	s násadou 1000 mm	1	0,470

Motyčka plečka



kód	EAN	popis		
211392	107	bez násady, 195x175mm	1	0,170
211242	107/550	s násadou 550 mm	1	0,340
211177	107/1000	s násadou 1000 mm	1	0,470

Motyčka plečka



kód	EAN	popis		
211320	007	bez násady, 195x140mm	1	0,260
211325	007/550	s násadou 550 mm	1	0,430
211328	007/1000	s násadou 1000 mm	1	0,560

Motyčka plečka



kód	popis		
211215	bez násady, 206x160 mm	50	0,320
211345	s násadou 160 cm	1	0,500

Lopatka sadenicová



kód	EAN	popis		
211335	008	60x320 mm	1	0,160
211180	009	80x320 mm	1	0,190

Náradie 900 mm

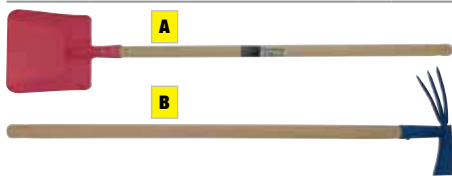

kód	popis		
211826	A) lopatka rovná, 15x64 cm	1	0,332
211827	B) motyčka plochá-3 zubá, 17x64 cm	1	0,320

Náradie 900 mm



kód	popis		
211822	Sada náradia / 3ks - A-B-E	1	1,330
211805	A) hlabie 11 zubé, 90 cm	1	0,375
211806	B) rýľ špicatý, 90 cm	1	0,375
2210825	C) metlička, 90 cm	1	0,375
211807	D) hlabie kovové 8 zubé, 90 cm	1	0,375
211808	E) motyčka plochá, 90 cm	1	0,375
211809	F) motyčka plochá-špicatá, 90 cm	1	0,375
211869	G) hlabie plastové, 90 cm	1	0,375

Sada náradia



kód	popis		
211430	lopatka, vidlička, kyprič	1	0,623

Sada náradia



kód	popis		
211452	2x lopatka, 1x vidlička	48	0,290

Sada náradia



kód	popis		
211918	3 dielna	10	1,130

Sada náradia

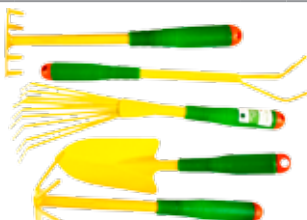

kód	popis		
211315	5 dielna	10	1,130

Sada náradia + podložka



kód	popis		
2210643	3 dielna - 1x kyprič, 2x lopatka	12	0,500

Sada náradia



kód	popis		
2110225	24x lopatka široká, 27 cm	6	2,500
2110226	24x lopatka úzka, 27 cm	6	2,167
2110227	24x kyprič, 27 cm	6	2,167

Odstraňovač na burinu



kód	popis		
2110232	3 hrotý, 100 cm	10	0,600

Krompáč, sklolaminát



kód	popis		
216666	2,0 kg	1	

Krompáč



kód	popis		
216572	1,5 kg	1	
216355	2,5 kg	1	
216154	1,5 kg, s násadou	1	
216121	2,5 kg, s násadou	1	

Krompáč podbiják



kód	popis		
216182	2,5kg / 63x6 cm	10	3,010

Krompáč špicatý, obojstranný



kód	popis		
216689	2,5 kg, 58 cm	1	2,500

Krompáč zalesňovací



kód	popis		
216522	1,5 kg, 5x38 cm	6	1,500
216156	1,5 kg, s násadou	1	2,300
216913	2,5 kg, bal. kartón	1	2,550
216643	2,5 kg, s násadou	1	3,500
216398	2,5 kg, bal. drôt	1	2,520

Krompáč FibreGlass



kód	popis		
2160224	1,5 kg, laminátová rúčka	10	2,650
216909	2,5 kg, laminátová rúčka	6	4,000

Krompáč požiarnický



kód	popis		
216748	bez násady, 43x6 cm	10	1,650
216381	s násadou	1	2,500

Krompáč požiarnický



kód	popis		
216537	2,25 kg, motyko-sekera, s násadou	1	

Násada hrablová



kód	popis		
261134	sklolaminátová	30	0,990

Násada hrablová



kód	popis		
261015	140 cm	10	0,600
261016	150 cm	10	0,670
261017	160 cm	10	0,685
261018	170 cm	10	0,785
261019	180 cm	10	0,795

Násada smetaková



kód	popis		
261059	120 cm	1	
261060	130 cm	1	
261061	140 cm	1	
261062	150 cm	1	
261063	160 cm	1	
261064	170 cm	1	
261065	180 cm	1	
261007	190 cm	1	
261067	200 cm	1	

Násada metlová so závitom



kód	popis		
261068	125 cm	1	

Násada vidlová



kód	popis		
261122	150 cm	10	1,215
261057	160 cm	1	

Násada lopatová



kód	popis		
261077	Classic, 1200 mm	1	0,900
261001	Classic, 1300 mm	10	1,015
261053	na lopatu 7131	1	0,850

Násada motyková



kód	popis		
261044	120 cm	1	0,435

Násada krompačová



kód	popis		
261050	na zalesňovací 1,5 kg	10	0,640
261047	na 2,5 kg	10	0,850
261140	na podbják	10	

Násada na kladivo



kód	popis		
261008	027 cm, tvar, 200 g	1	0,070
261011	030 cm, tvar, 400 g	10	0,090
261012	032 cm, tvar, 600 g	10	0,160
261013	035 cm, tvar, 800 g	10	0,140
261014	036 cm, tvar, 1 kg	10	0,215
261097	038 cm, tvar, 1,5 kg	10	0,195
261092	040 cm, tvar, 2 kg	10	0,210
261093	045 cm, tvar, 3 kg	10	0,280
261020	050 cm, tvar, 3 kg	10	0,330
261095	060 cm, tvar, 4 kg	10	0,375
261098	070 cm, tvar, 5 kg	1	0,560
261102	080 cm, tvar, 6 kg	10	0,595
261106	090 cm, tvar, 7 kg	10	0,740
261103	100 cm, tvar, 8 kg	10	1,095

Násada na sekeru



kód	popis		
261080	30 cm	10	
261071	35 cm	10	0,210
261079	40 cm	10	0,225
261055	45 cm	1	0,300
261078	50 cm	10	0,410
261005	60 cm	10	0,465
261075	70 cm	10	0,510
261076	80 cm	10	0,795
261101	90 cm, kalačková	10	
261999	90 cm	10	
261150	100 cm	10	

Násada rýľová



kód	popis		
261003	A) zrezaná, 100 cm	10	0,750
261105	B) "T"	10	0,860
261088	C) plast "Y", 100 cm	10	0,705

Držadlo na násadu



kód	popis		
211068	plast "Y"	100	0,102

Sada klinkov



kód	popis		
212654	3024/08, 15 ks	1	2,10
212914	3024/10, 10 ks	1	0,050
212915	3024/12, 12 ks	1	0,070
212964	3024/14, 10 ks	1	0,100
212916	3024/16, 8 ks	1	0,100
212917	3024/18, 6 ks	1	0,100

Klinok Fe



kód	popis		
212985	malý	1	0,010
212518	stredný	1	0,015
212570	veľký	1	0,020

Klinky do sekery



kód	popis		
212584	20x25x5 mm, bal. 3ks	50	
212628	30x40x5 mm, bal. 3ks	50	

Motyka špicatá

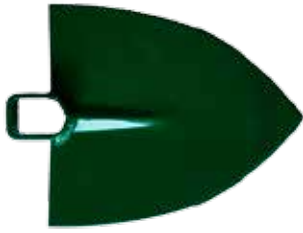

kód	popis		
211238	400 g, 16.5x18.5 cm	40	0,400
211629	500 g, 16.5x18.5 cm	20	0,500
211251	600 g, 16.5x18.5 cm	20	0,600
211053	400 g, s násadou	1	1,300
211032	500 g, s násadou	1	1,400
211200	600 g, s násadou	1	1,500

Motyka špicatá



kód	popis		
211252	400 g, 12.5x16.5 cm	1	0,400
211282	500 g, 12.5x16.5 cm	1	0,500
211283	600 g, 12.5x16.5 cm	1	0,600
211145	400 g, s násadou 1200 mm	1	1,400
211295	500 g, s násadou 1200 mm	1	1,500
211004	200 g, s násadou 1200 mm	1	1,200

Motyka plochá

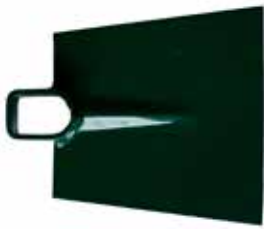

kód	popis		
211171	400 g, 14.5x17 cm	1	0,400
211729	s násadou, 14.5x17x120 cm	1	1,400
211291	350 g, 12.5x12.5 cm	1	0,350
211400	s násadou, 12.5x12.5x120 cm	1	1,400

Motyka plochá



kód	popis		
211151	300 g, 16x9.5 cm	1	0,300
211290	s násadou, 16x9.5x120 cm	1	1,300
211292	400 g, 14.5x14.5 cm	1	0,400
211281	s násadou, 14.5x14.5x120 cm	1	1,300

Motyka plochá



kód	popis		
211284	250 g, 7.5x15 cm	1	0,250
211277	s násadou, 7.5x15x120 cm	1	1,200

Motyka plochá



kód	popis		
2110188	zelená, 11x16 cm	40	0,400
2110241	zelená s násadou, 11x16x120 cm		

Motyka plochá, úzka



kód	popis		
2110189	zelená, 8x19 cm	40	0,450
2110242	zelená s násadou, 8x19x120 cm		

Motyka srdcová



kód	popis		
2110190	zelená, 14x16 cm	40	0,500
2110243	zelená s násadou, 14x16x120 cm		

Motyka plochá



kód	popis		
2110187	zelená, 11x18 cm	40	0,400
2110235	zelená s násadou, 11x18x120 cm		

Motyka záhradnícka



kód	popis		
211828	špicatá-dvojhrotá, 280 g, 2.9x8 cm	1	0,280

Ohrablo na mrvu



kód	popis		
211066	bez násady, 33x9.5 cm	10	2,250
216155	s násadou, 33x9.5x130 cm	1	0,900

Vrták zemný do pôdy



kód	popis		
217390	150 mm / 90 cm / 1z	1	

Vrták zemný do pôdy



kód	popis		
217348	150 mm / 108 cm / 2z	1	
217440	200 mm / 108 cm / 2z	1	
217526	250 mm / 108 cm / 1z	1	

Motyka kovaná, roháčka



kód	popis		
211157	450 g; špicatá-dvojhrotá	1	

Motyka kovaná, rumunská



kód	popis		
211268	750 g	1	

Motyka Gardex, kovaná



kód	popis		
211271	1100 g, 24x11.8 cm, Budak	24	1,100

Motyka plochá, kovaná



kód	popis		
211393	600 g, bez násady, 14x13.5 cm	32	0,600
211174	600 g, s násadou, 120 cm	1	1,300

Motyka špicatá, kovaná



kód	popis		
211244	390 g, bez násady, 11.5 cm	50	0,390
211312	390 g, s násadou	1	1,200
211321	630 g, bez násady, 15 cm	30	0,630
211398	630 g, s násadou	1	1,500
211372	680 g, bez násady, 14.5 cm	32	0,680
211138	680 g, s násadou	1	1,500
211380	730 g, bez násady, 18 cm	24	0,730
211381	730 g, s násadou	1	1,730
211231	760 g, bez násady, 19 cm	1	0,760
211207	760 g, s násadou	1	1,760
211232	840 g, bez násady, 20 cm	1	0,840
211248	840 g, s násadou	1	1,840

Motyka záhradnícka, kovaná



kód	popis		
211125	300 g, bez násady, 6.5x22 cm	36	0,300
211164	300 g, s násadou 120 cm	1	0,800

Motyka úzka, kovaná



kód	popis		
211126	568 g, bez násady, 22.5x8.5 cm	1	0,568
211160	568 g, s násadou 120 cm	1	1,500

Motyka zalesňovacia, kovaná



kód	popis		
211208	750 g, bez násady, 7x24 cm	1	0,750
211163	750 g, s násadou, 7x24x120 cm	1	1,500

Motyka úzka, kovaná Kudal



kód	popis		
211457	550 g, bez násady, 19.5x6.5 cm	1	0,550
211490	550 g, s násadou, 120 cm	1	0,950

Ručná plečka



kód	popis		
211621	dĺžka 155cm, Ø kolečka 27cm	1	2,000
211153	rydlo náhradné	1	0,500
211175	pluh náhradný	1	0,650

Príslušenstvo k plečke



kód	popis		
211175	pluh náhradný	1	0,650

Príslušenstvo k plečke



kód	popis		
211153	rydlo náhradné	1	0,500

RÝLE / SPADES

Rýľ rovný s násadou D **FarmLine**



kód	popis		
211438	120 cm, oceľ, ergonomická	1	

Rýľ špicatý s násadou **FarmLine**



kód	popis		
211561	120 cm, oceľ, ergonomická	1	

Rýľ špicatý s násadou **FarmLine**



kód	popis		
211574	70 cm, oceľ, ergonomická	1	

Lopata rovná **FarmLine**



kód	popis		
211583	120 cm, oceľ, ergonomická	1	

Rýľ špicatý s násadou D



kód	popis		
211443	115 cm / sklolaminát	6	1,730

Rýľ rovný s násadou, Drev



kód	popis		
211723	114,5x19 cm	6	1,750

Rýľ rovný s násadou, FibreGlass



kód	popis		
211720	114,5x19 cm	6	1,750

Rýľ špicatý s násadou, Drev

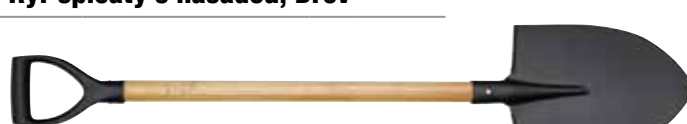

kód	popis		
211722	115 cm	6	1,750

Lopata s násadou, FibreGlass

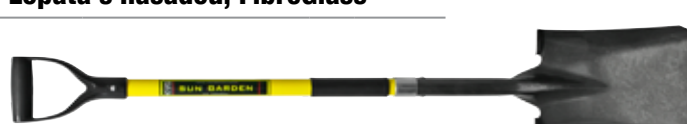

kód	popis		
211701	gumový držiak / 115x23 cm	6	1,750

Vidly 4-hroté s násadou **FarmLine**



kód	popis		
211582	120 cm, oceľ, ergonomická	1	

Vidly rycie s násadou **FarmLine**



kód	popis		
211581	120 cm, oceľ, ergonomická	1	

Vidly s násadou, Drev



kód	popis		
211724	115 cm / 4-hroté	6	1,730

Vidly s násadou, FibreGlass

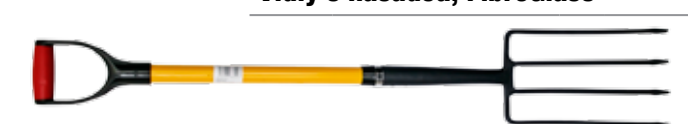

kód	popis		
211721	115X18 cm / 4-hroté	6	1,930

Rýľ štychar



kód	popis		
211716	380 mm, s násadou 115 cm	6	1,950
211192	380 mm, bez násady 52 cm	12	1,250

Rýľ štychar, s násadou D



kód	popis		
211366	115x59.5 cm / sklolaminát	6	1,950

Rýľ a vidly s násadou, sklolaminát



kód	popis		
2110217	A) Rýľ rovný 117x19 cm	1	2,360
2110218	B) Rýľ špicatý 121x20 cm	6	2,210
2110219	C) Vidly rycie 122x19 cm	6	2,160

Kosa kovaná, Styria



kód	popis		
211374	600 mm	1	0,650
211378	700 mm	1	0,700
211375	800 mm	1	0,800
211106	900 mm	1	0,600

Kosa kovaná, Sobol'



kód	popis		
211209	500 mm	30	0,366
211009	600 mm	25	0,470
211010	700 mm	25	0,540
211011	800 mm	20	0,625
211385	900 mm	20	0,685

Kosa kovaná, Saiga



kód	popis		
211025	500 mm	1	0,315
211109	600 mm	20	0,455
211116	700 mm	20	0,550
211541	800 mm	20	0,625
211542	900 mm	25	0,685

Kosa



kód	popis		
211902	600 mm	50	0,500
211903	700 mm	50	0,600
211221	800 mm	50	0,700

Mačeta s plastovou rúčkou



kód	popis		
239221	300 mm	50	0,460
239209	400 mm	50	0,480
239219	450 mm	50	0,460
239220	500 mm	50	0,480
239415	560 mm	50	0,405

Mačeta s drevenou rúčkou



kód	popis		
236045	300 mm	50	0,420
236096	400 mm	50	0,500
236046	450 mm	50	0,480
236047	500 mm	50	0,405
236156	560 mm	50	0,520

Kosa kovaná s kosiskom

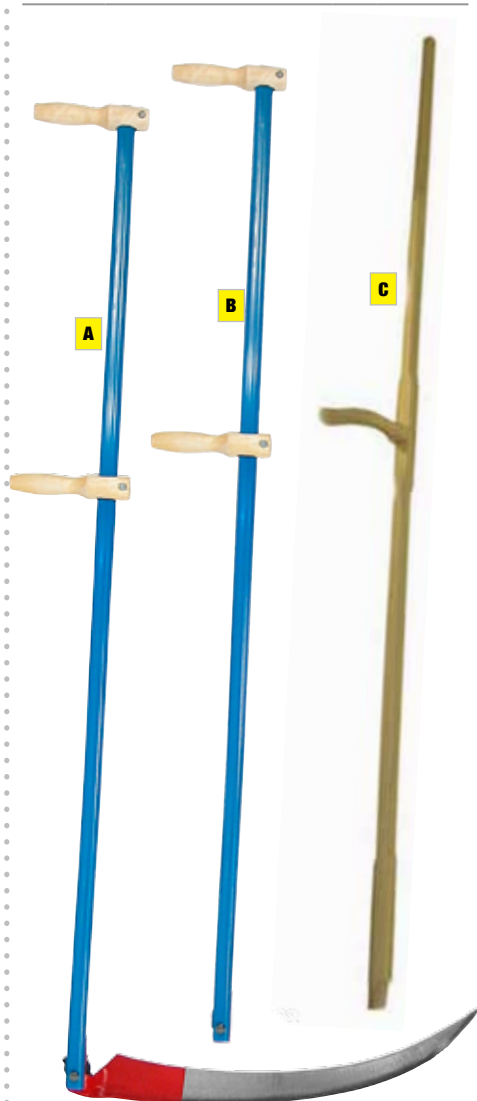

kód	popis		
211108	A) kosa 700 mm + kosisko	1	3,500
211059	B) samostatné železné kosisko	1	0,400
211240	C) samostatné drevené kosisko	1	

Objímka na kosu

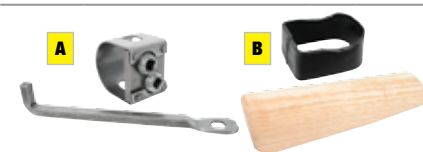

kód	popis		
211182	A) 2x skrutka + klúčik	100	0,105
211302	B) drevený klinok	236	0,089

Mačeta s plastovou rúčkou



kód	popis		
236214	250 mm	50	0,460

Brúska, oslička



kód	popis		
211311	Carborundum 13x230 mm	1	0,200

Brúska, oslička

kód	popis		
211467	Rozsutec, kamenná	1	0,250

Brúska, oslička

kód	popis		
211571	oválna 230x350x13 mm	100	0,190

Brúsny kameň

kód	popis		
211575	225x75x50	50	0,500

Púzdro na brúske osličky

kód	popis		
211087	Zn	200	0,105

Naklepávač na kosu

kód	popis		
211761	A) ostrá	50	0,400
211373	B) štvorhranná	40	0,500

Naklepávač

kód	popis		
211140	na kosu	1	1,000

Kosák



kód	popis		
211429	450x35 mm	1	0,400

Kosák Minikosa



kód	popis		
211600	355 mm	50	0,400

Kosák



kód	popis		
211123	355 mm	50	0,290

Kosák



kód	popis		
211119	275 mm, na trávnik	50	0,276

Kosák zúbkovaný



kód	popis		
211604	03 mm	60	0,270

Lopata Holšteinská



kód	popis		
211016	bez násady / 245x270 mm	1	0,900

Vidly na seno, KomaXit



kód	popis		
211700	2 hroté	1	0,563

Vidly na seno, KomaXit



kód	popis		
211712	bez násady	24	0,660
211167	s násadou	1	1,000

Vidly na seno, KomaXit



kód	popis		
211710	bez násady	24	0,770
211510	s násadou	1	1,800

Vidly 3-hroté, široké

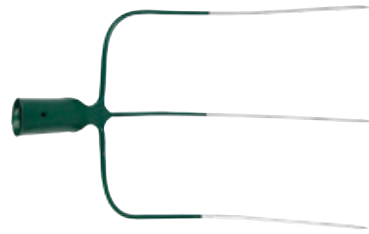

kód	popis		
211189	bez násady	1	0,660
211055	s násadou	1	1,600

Vidly 4 hroté široké



kód	popis		
211188	bez násady	24	0,770
211275	s násadou	1	1,700

Vidly 4-hroté rycie, KomaXit



kód	popis		
211056	bez násady, zvárané, široké	20	1,100
211316	s násadou rovnou	1	
211269	s násadou PH	1	
211859	s násadou T	1	

Vidly 4-hroté rycie



kód	popis		
211666	bez násady, úzke	24	1,146
211222	s násadou PH	1	
211218	s násadou T	1	

Vidly 4 hroté, kopáče



kód	popis		
211041	bez násady, KomaXit	24	0,770

Vidly 9 hroté, na štrk



kód	popis		
211448	bez násady	12	1,750

Lopata Vachy



kód	popis		
211147	malá, plast / 245x260 mm	1	0,500

Lopata špicatá



kód	popis		
211017	A) bez násady / 265x270 mm	1	0,908
211223	A) s násadou	1	1,500
211191	B) bez násady / 265x270 mm	1	1,000

Lopata rovná KomaXit 7131



kód	popis		
211213	A) bez násady / 185x260 mm	1	0,900
211293	A) s násadou	1	1,500
211286	B) bez násady / 185x260 mm	1	0,916

Lopata rovná

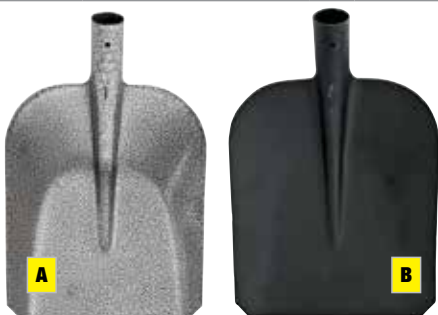

kód	popis		
211130	A) bez násady / 280x235 mm	12	0,908
211747	A) s násadou	1	1,500
211343	B) bez násady / 280x235 mm	1	0,910

Lopata frankfurtská KomaXit

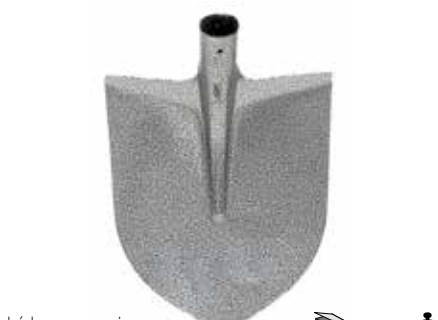

kód	popis		
211246	bez násady / 250x275 mm	12	1,000
211236	s násadou	1	1,500

Lopata Univerzal KomaXit

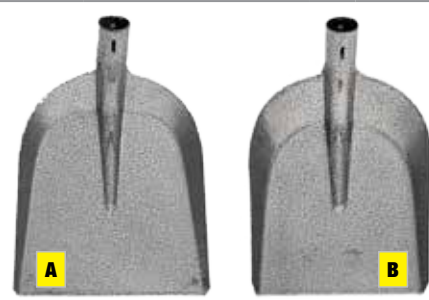

kód	popis		
211717	A) bez násady / 286x265 mm	12	1,009
211330	A) s násadou	1	1,800
211718	B) bez násady / 280x235 mm	12	1,009
211020	B) s násadou	1	1,800

Lopata Univerzal KomaXit

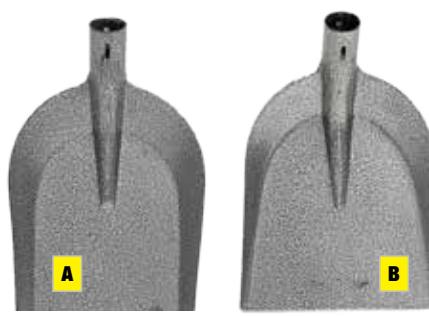

kód	popis		
211670	A) bez násady / 270x220 mm	1	1,000
211565	A) s násadou	1	1,800
211719	B) bez násady / 275x235 mm	12	0,915
211439	B) s násadou	1	1,800

Lopata hliníková



kód	popis		
211766	A) bez násady / 270x280 mm	1	0,350
211015	A) s násadou	1	1,100
211691	B) bez násady / 350x355 mm	1	0,600
211693	B) s násadou	1	1,400

Lopata kalená



kód	popis		
211285	bez násady / 350x355 mm	1	1,900
211397	s násadou	1	2,200

Rýľ rovný KomaXit



kód	popis		
211788	bez násady	12	0,925
2110089	A) s násadou	1	2,000
2110095	B) s násadou PH	1	2,000
2110093	C) s násadou T	1	2,000

Rýľ špicatý KomaXit

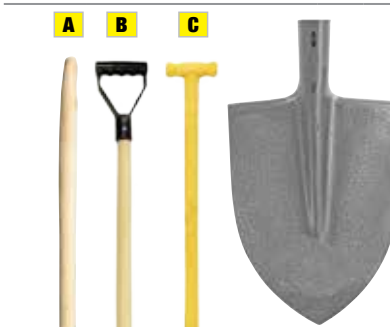

kód	popis		
211566	bez násady	12	0,900
211306	A) s násadou 126x20 cm	1	1,600
211265	B) s násadou PH 126x20 cm	1	1,600
211141	C) s násadou T 126x20 cm	1	1,600

Rýľ špicatý, kovaný



kód	popis		
211046	1250 g, 19x30 cm	20	1,250
211057	1250 g, s násadou PY 134x19 cm	1	2,300
211187	1250 g, s násadou T 135x19 cm	1	2,300
211459	1250 g, s násadou 138x19 cm	1	2,300

Rýľ špicatý, kovaný s ohybom



kód	popis		
211699	1300 g, 19.5x31 cm	15	1,300
211359	1300 g, s násadou PY 130x19.5 cm	1	2,300
211688	1300 g, s násadou 130x19.5 cm	1	2,300
211095	1300 g, s násadou T 132x19.5 cm	1	2,300

Hrable na listie

AQUACRAFT



kód	popis		
211364	15 lamelové / 122-166 cm	1	0,791

Hroty s pozinkovanej pružnej ocele. Nastaviteľná šírka záberu od 30 do 50 cm. Vysoko kvalitná konštrukcia z trvácneho a odľahčeného hliníka

Hrable na listie

AQUACRAFT



kód	popis		
211932	18 lamelové, 157 cm	1	

Vyrobené z vysoko kvalitnej ocele, odolné proti korózii. Pevná ocelová protišmyková rukoväť.

Hrable na listie

AQUACRAFT



kód	popis		
211931	22 lamelové, 158 cm	1	

Vyrobené z vysoko kvalitnej ocele, odolné proti korózii. Pevná ocelová protišmyková rukoväť.

Hrable záhradné

AQUACRAFT

Vyrobené z vysoko kvalitnej ocele, odolné proti korózii. Pevná ocelová protišmyková rukoväť.



kód	popis		
211933	14 zubé, 155 cm	1	

Hrable záhradné, na listie



kód	popis		
211872	45.5x30 cm, 18 lamelové, Zn	1	0,760

Hrable na listie, lamelové



kód	popis		
211159	37x44 cm, 22 lamiel	40	0,320
211417	s násadou	1	1,000

Hrable na listie, nastaviteľné

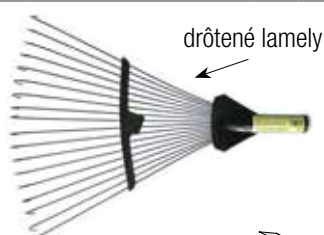

kód	popis		
211161	18 lamiel	50	0,482
211801	s násadou	1	0,500

Hrable na listie, drôtené

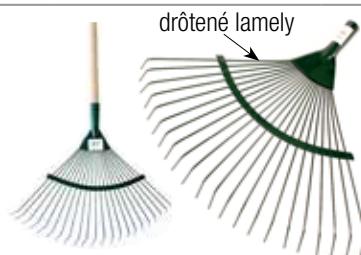

kód	popis		
211412	22T	25	0,460
211416	s násadou	1	0,808

Hrable na listie, sklolinát



kód	popis		
2110220	A) 14 zubé / 1500 mm	6	1,200
2110221	B) 22 zubé / 1500 mm	6	1,050

Hrable na listie nastaviteľné, Zn

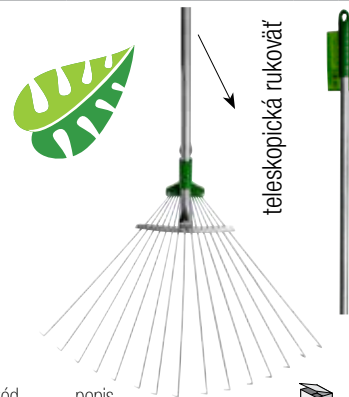

kód	popis		
211436	teleskopická rukoväť	12	0,780

Hrable na listie nastaviteľné, Zn

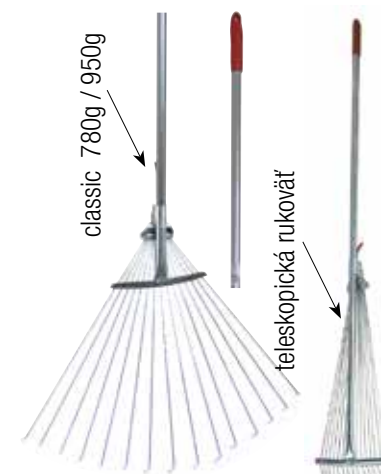

kód	popis		
211026	Strong 950g, zelený gumový držiak	12	0,950
211758	Light 780g, červený gumový držiak	12	0,780

Hrable na listie nastaviteľné, Zn

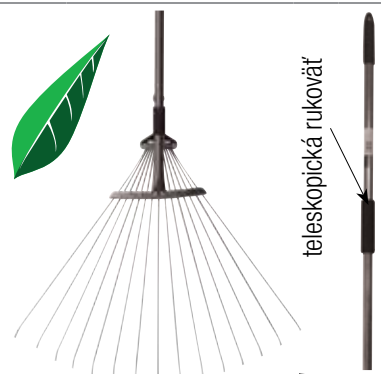

kód	popis		
211870	155 cm	1	0,820

Hrable záhradné, prevzdušňovacie



kód	popis		
211254	11/21T	12	1,160
211418	s násadou	1	1,170

Hrable na lístie



kód	popis		
211156	A) 24T, násada 1200 mm, drevo	18	0,720
211190	B) 24T násada 1200 mm, sklolaminát	6	0,940

Hrable na lístie so závitom



kód	popis		
211120	22 lamiel, PH, s násadou	28	0,607
211241	22 lamiel, bez násady	30	0,337

Hrable záhradné, na lístie



kód	popis		
211689	s násadou / 23 zubé	1	0,100

Hrable plastové

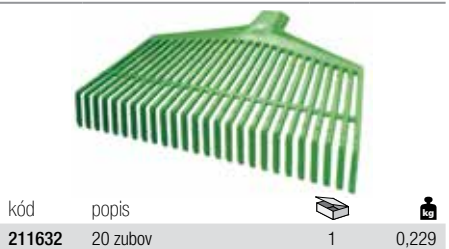

kód	popis		
211632	20 zubov	1	0,229

Hrable s urovňavacou lištou



kód	popis		
211825	bez násady	1	0,100
211560	s násadou	1	0,700

Hrable záhradné, na lístie



kód	popis		
211558	23 zubé	1	0,210

Hrable na lístie, plastové

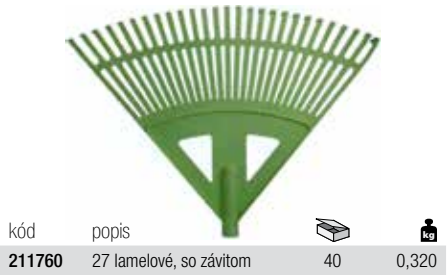

kód	popis		
211760	27 lamelové, so závitom	40	0,320

Hrable plastové na lístie

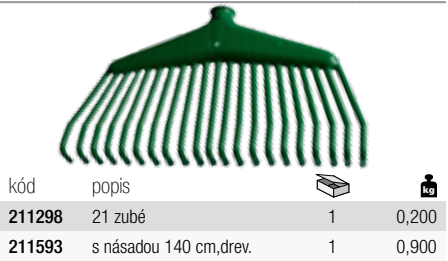

kód	popis		
211298	21 zubé	1	0,200
211593	s násadou 140 cm, dřev.	1	0,900

Hrable LongBow



kód	popis		
211463	červené, 16 zubé	5	0,225
211205	červené 16 zubé s násadou	1	1,250
211054	čierne, 18 zubé	1	0,387
211206	čierne, 18 zubé s násadou	1	1,320

Hrable Classic

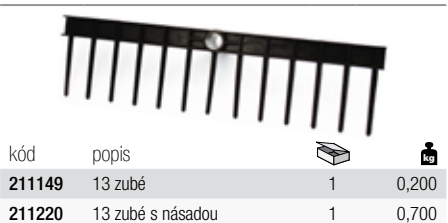

kód	popis		
211149	13 zubé	1	0,200
211220	13 zubé s násadou	1	0,700

Hrable drevené

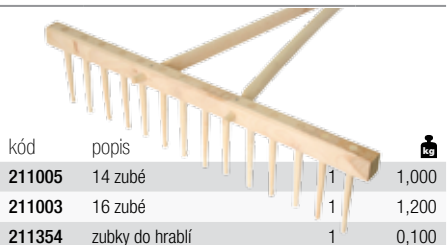

kód	popis		
211005	14 zubé	1	1,000
211003	16 zubé	1	1,200
211354	zubky do hrabí	1	0,100

Hrable kované, 1 kus



kód	popis		
211239	10 zubé	1	
211261	12 zubé	1	
211388	14 zubé	1	
211260	16 zubé	1	
211111	10 zubé, s násadou	1	
211122	12 zubé, s násadou	1	
211136	14 zubé, s násadou	1	
211287	16 zubé, s násadou	1	

Hrable na kameň, kované



kód	popis		
211684	10 zubé	1	
211685	12 zubé	1	
211678	14 zubé	1	
211686	16 zubé	1	
211676	10 zubé s násadou, 140 cm	1	
211677	12 zubé s násadou, 160 cm	1	
211764	14 zubé s násadou, 160 cm	1	
211680	16 zubé s násadou, 170 cm	1	

Hrable záhradné



kód	popis		
211101	10 zubé	25	0,390
211117	12 zubé	25	0,440
211135	14 zubé	25	0,490
211139	16 zubé	25	0,540
211006	10 zubé, s násadou 160 cm	1	0,900
211229	12 zubé, s násadou 160 cm	1	1,060
211228	14 zubé, s násadou 160 cm	1	1,120
211322	16 zubé, s násadou 160 cm	1	1,180

Hrable na trávnik



kód	popis		
211767	12 zubov, bez násady	25	0,500
211759	14 zubov, bez násady	25	0,620
211768	16 zubov, bez násady	25	0,700
211762	14 zubov, s násadou	1	1,000
211362	12 zubov, s násadou	1	1,000
211363	16 zubov, s násadou	1	1,000

Hrable záhradné, na lístie

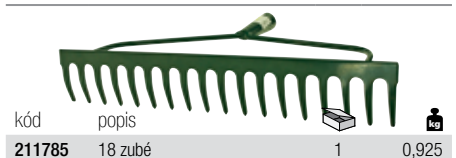

kód	popis		
211785	18 zubé	1	0,925

Hrable záhradné, nylon

NOVINKA



kód	popis		
211402	12 zubé, bez násady	1	
211399	18 zubé, bez násady	1	
211262	násada 161 cm	1	

Násada hrabľová

NOVINKA



kód	popis		
261006	161 cm, kompatibilná	1	

Hrable záhradné, PET

NOVINKA



kód	popis		
211725	13 zubé, 240 mm, bez násady	1	
211751	23 zubé, 480 mm, bez násady	1	
211262	35 zubé, 760 mm, bez násady	1	
211262	násada 161 cm	1	

Hrable

NOVINKA



kód	popis		
211210			

Materiál: CO - PP/PVC/hliník
 Rozmery: 104x35x18 cm
 - Teleskopická rukoväť.
 - jednoduché hrabanie drobného listia, kameňov alebo odpadu.

Nástroj 3v1

NOVINKA



kód	popis		
211296	bez násady		
211233	s 120 cm železnou násadou		

Rozmery bez násady: 44x39x38 cm
 Rozmery s násadou: 168x30x40.5 cm
 Materiál: HS-ABS / železo
 - Jedinečný vzhľad.
 - Vyrobený z odľahčeného materiálu.
 - Výborná odolnosť
 - 3 v 1: hrable, lopata a sito.

Hrable záhradné, prevzdušňovacie

NOVINKA



kód	popis		
211204	11 zubé, 33.5x20 cm	1	

Hrable záhradné, prevzdušňovacie

NOVINKA



kód	popis		
211249	11 zubé, 46.5x25 cm, na kolieskach	1	

Zberač ovocia

NOVINKA



kód	popis		
211186	bez teleskopickej násady		
211113	s 120 cm teleskop. násadou		

Veľkosť zberaného ovocia: 3-10 cm

Rozmery bez násady: 30x32 cm
 Rozmery s násadou: 95-145x30x32 cm
 Materiál: PA/ABS/hliník/netoxické PVC
 Objem: 6 lit.
 Nosnosť: 2 kg
 - Vyrobený z odľahčeného materiálu.
 - Ľahko ovládateľný.
 - Odolná plastová konštrukcia.
 - Šetrí čas.
 - Umožňuje pohodlný zber bez nutnosti sa zohnúť či kľaknúť si.
 - Efektivejší zber.
 - Na zber ovocia väčších rozmerov.

Zberač ovocia

NOVINKA



kód	popis		
211128	bez teleskopickej násady		
211114	s 110 cm teleskop. násadou		

Veľkosť zberaného ovocia: 1,5-6,5 cm

Rozmery bez násady: 24x28 cm
 Rozmery s násadou: 86-130x24x28 cm
 Materiál: PA/ABS/hliník/netoxické PVC
 Objem: 2,2l
 Nosnosť: 1,2 Kg
 - Vyrobený z odľahčeného materiálu.
 - Ľahko ovládateľný.
 - Odolná plastová konštrukcia.
 - Šetrí čas.
 - Umožňuje pohodlný zber bez nutnosti sa zohnúť či kľaknúť si.
 - Efektivejší zber.
 - Na zber ovocia malých rozmerov.



LOPATY NA SNEH A ŠKRABKY

Lopata na sneh



kód	popis		
217984	435x330 mm	1	

Lopata na sneh



kód	popis		
217915	480x390 mm	1	

Lopata na sneh



kód	popis		
217088	440x335 mm	1	

Odolná voči nárazu / protišmyková podložka / kovová násada

Lopata na sneh



kód	popis		
2170031	460x370 mm	1	

Odolná voči nárazu / protišmyková podložka / kovová násada

Lopata na sneh



kód	popis		
217091	385x550 mm	1	

Odolná voči nárazu / výkonná a robustná so širokou čepelou / ergonomická kovová násada

Lopata na sneh



kód	popis		
2171078	450x415 mm	1	

Odolná voči mrazu / plastové držadlo / drevená násada

Lopata na sneh



kód	popis		
2170252	395x520 mm	1	

Je bezkonkurenčná v tých najťažších podmienkach / ľahko si poradí s ľadom či s topiacim snehom / kovová násada / protišmyková podložka

Lopata na sneh



kód	popis		
2170251	385x550 mm	1	

Je bezkonkurenčná v tých najťažších podmienkach / ľahko si poradí s ľadom či s topiacim snehom / ergonomická protišmyková kovová násada / vynikajúce vlastnosti čepele v kombinácii s vynikajúcou príľnavosťou dvojbodového nastavenia systému

Odhřňač na sneh



kód	popis		
211324	1400x800x460 mm	1	

Lopata kovová na sneh



kód	popis		
211432	bez násady 500 mm	1	
211433	s násadou 500x1300 mm	1	

Lopata kovová na sneh



kód	popis		
2110224	bez násady 380x380 mm	1	
2110229	s násadou 380x380x1300 mm	1	

Lopata kovová na sneh



kód	popis		
217212	350x440x1400 mm, kovová	1	

Škrabák na ľad bez výstuže



kód	popis		
221501	bez násady / 150 mm	1	
221506	bez násady / 200 mm	1	
221505	bez násady / 300 mm	1	
221038	s násadou / 150 mm	1	
221037	s násadou / 200 mm	1	
221024	s násadou / 300 mm	1	

Škrabák na ľad



kód	popis		
212604	s násadou / 150x70x1100 mm	1	

Škrabák na ľad



kód	popis		
222803	kovový / 200x1070 mm	1	

Škrabka na ľad



kód	popis		
222855	250x97 mm, plast	1	

Škrabka na ľad



kód	popis		
222852	180x116 mm, plast+guma	1	

Škrabka na ľad



kód	popis		
222801	225x110 mm, plast	1	

Škrabka na ľad



kód	popis		
222870	162x95 mm, plast+guma+medená čepeľ	1	

Škrabka na ľad



kód	popis		
222240	300 mm, mäkká a pohodlná rúčka	1	

Škrabka na ľad s metličkou 2v1



kód	popis		
222121	500 mm, mäkká a pohodlná rúčka	1	
222978	750 mm, mäkká a pohodlná rúčka	1	

Škrabka na ľad s metličkou 2v1



kód	popis		
222527	870-1140 mm, mäkká a pohodlná teleskopická rúčka	1	

Škrabka na ľad s metličkou 2v1



kód	popis		
222869	A) 405x090 mm, plast	1	
222868	B) 400x115 mm, plast	1	

Škrabka na ľad s rukavicou



kód	popis		
222859P	A) 280x150 mm, plast	1	
222811	B) 370x100 mm, plast	1	

Fúrik záhradný Hobby



kód	popis		
2160889	70 lit., Zn, koleso nafukovacie plech 0,6 mm	1	
217173	náhradná duša	1	

Fúrik záhradný AT



kód	popis		
2160887	85 lit., Zn, koleso nafukovacie plech 0,9 mm	1	
2160891	90 lit., Zn, koleso nafukovacie	1	
217173	náhradná duša	1	

Fúrik s nafukovacím kolesom, Fe



kód	popis		
216634	komplet, Fe, 60 lit.	1	12,700
216412	korba 60 lit. / Fe	1	3,700
217979	koleso na fúrik / nafukovacie	1	2,460
217975	duša na koleso k fúriku	10	0,350
217931	plášť na koleso k fúriku	1	0,733

Fúrik s nafukovacím kolesom, Zn



kód	popis		
216692	komplet, Zn, 60 lit.	1	12,700
216411	korba 60 lit. / Zn	1	3,700
217979	koleso na fúrik / nafukovacie	1	2,460
217975	duša na koleso k fúriku	10	0,350
217931	plášť na koleso k fúriku	1	0,733

Fúrik Cargo, bantam



kód	popis		
216316	komplet, Fe, 60 lit.	1	16,600
2160512	komplet, Fe, 85 lit.	1	17,300
216412	korba 60 lit. / Fe	1	3,700
2160532	korba 85 lit. / Fe	1	4,100
216545	koleso na fúrik / bantam	1	6,340
2160530	Oska 220/16 mm	1	
2160810	Ložisko	1	

Fúrik Cargo, bantam



kód	popis		
216701	komplet, Zn, 60 lit.	1	16,600
2160513	komplet, Zn, 85 lit.	1	17,300
216411	korba 60 lit. / Zn	1	3,700
2160514	korba 85 lit. / Zn	1	4,100
216545	koleso na fúrik / bantam	1	6,340
2160530	Oska 220/16 mm	1	
2160810	Ložisko	1	

Fúrik záhradný



kód	popis		
216580	60 lit., Fe, koleso bantam	1	12,000

Rúčka na fúrik, gumová

kód	popis		
217729	rúčka pre Cargo fúriky	1	0,040
2170518	rúčka pre fúriky s nafukovacím kol.	1	0,050

Fúrik záhradný KIPTL



kód	popis		
2160888	100 lit., fúrik s plastovou korbou	1	

Fúrik GreenLawn



kód	popis		
216624	100 lit. fúrik s plastovou korbou	1	11,000
2160531	100 lit, plastová korba	1	3,000
2160725	Oska	1	

Fúrik GreenLawn



kód	popis		
216850	140 lit. fúrik s plastovou korbou	1	20,000
216695	180 lit. fúrik s plastovou korbou	1	20,000
217585	koleso náhradné	1	
2160725	Oska	1	

Fúrik GreenLawn TITAN



kód	popis		
2160728	180 lit. fúrik s plastovou korbou	1	22,500
2160727	korba plastová 180 lit.	1	
2160724	koleso náhradné	1	
2170517	oska 25/550 mm		
2170518	gumová rukoväť		

Vozík záhradný



kód	popis		
2170699	930x505x510/895 mm nafukovacie koleso 10x3.50-4 nosnosť max. 250 kg korba: plastová konštrukcia: kovová	1	17,300
2170776	koleso náhradné	1	

Vozík záhradný



kód	popis		
2170702	960x520x570 mm nafukovacie koleso 3.50-4 nosnosť max. 300 kg korba: kovová konštrukcia: kovová	1	28,000
2170772	koleso náhradné	1	

Vozík záhradný



kód	popis		
2170999	1250x650x590 mm nafukovacie koleso 3.50-4 nosnosť max. 250 kg korba: kovová konštrukcia: kovová	1	25,000
2170772	koleso náhradné	1	

Vozík záhradný



kód	popis		
2170700	1120x735x740 mm nafukovacie koleso 13x5.00-6 nosnosť max. 25 kg	1	14,200
Použitie: rozmetač sypkých materiálov			
2170775	koleso náhradné	1	

Vozík záhradný



kód	popis		
2170701	1000x485x690 mm koleso 9"x2.3" nosnosť max. 25 kg	1	4,410
Použitie: rozmetač sypkých materiálov			
2170774	koleso náhradné	1	

Vozík záhradný



kód	popis		
2170703	920x610x980 mm nafukovacie koleso 3.00-4 nosnosť max. 100 kg korba: drevená konštrukcia: kovová	1	17,000
2170773	koleso náhradné	1	

Kôš na listie



kód	popis		
221916	60 lit	20	1,160

Fúrik mini záhradný



kód	popis		
216623	20 lit. fúrik s plechovou korbou	1	3,800
rozmer fúrika: 88x41x37 cm / rozmer korby: 51x41x10 cm koleso: 7"x1.5"			

Vozík na záhradný odpad



kód	popis		
212238	A) 55 lit. / 53x59x90 cm	1	1,820
2170326	B) 20 lit. / nosnosť 25kg	1	1,000

Vozík na záhradný odpad

NOVINKA



kód	popis		
212251	85 lit. / 98x60x69 cm	1	

Vozík na záhradný odpad

AQUACRAFT



kód	popis		
211230	53x38x90 cm nosnosť max. 50 kg objem 120 lit.	1	3,205

MLYNČEKY, LISY A REZAČKY

Mlynčeky na hrozno a ovocie



PLECH



A) na ovocie

B) na hrozno



kód	popis		
2211078	A) 25 lit. / 70x40x38 cm	1	
2211077	B) 25 lit. / 70x40x38 cm	1	

Mlynčeky na hrozno a ovocie



NEREZ



SMALT

A) na ovocie

B) na hrozno



kód	popis		
221775	A) 800x500 mm, nerezové	1	
221836	A) 950x600 mm, nerezové	1	
221767	B) 950x600 mm, nerezové	1	
221765	B) 800x500 mm, smaltované	1	
221766	B) 950x600 mm, smaltované	1	

Odstopkovač ručný na hrozno

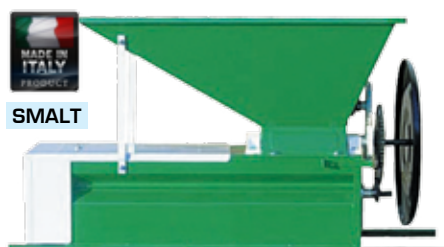

SMALT

kód	popis		
221768	1000x200x150 mm	1	

Lis na hrozno s rámom



kód	popis		
221588	12 lit.	1	11,800
221589	18 lit.	1	28,300

Lis na hrozno



kód	popis		
221900	06 lit. / 33x32x60 cm	1	10,800
221585	12 lit. / 40x40x70 cm	1	11,800
221586	18 lit. / 40x40x78 cm	1	14,600
221587	30 lit.	1	17,700

Filtračné vreće do lisu



kód	popis		
2210909	06 lit.	1	
2210910	12 lit.	1	
2210911	18 lit.	1	
2210912	30 lit.	1	
2210913	12 lit. / do lisu s rámom	1	
2210914	18 lit. / do lisu s rámom	1	

Vinomer



kód	popis		
2210958	0-25%	1	

Odstopkovač motorový



SMALT

kód	popis		
221771	600x600x1200 mm	1	

Váha: 54 kg / Prikon: 0,75 kW / Násypka: 900 x 500 mm / Ø hliníkových valcov: 220 mm / Otáčky: 1400 rpm / Výkon za hodinu: 1500 kg / Napätie a frekvencia: 220 V – 60 Hz / Prevádzková teplota: 5° - 45°C / Hlučnosť: do 70 dB

Demizón, sklo/plast



kód	popis		
221409	05 lit. / 320x250x200 mm	1	1,720
221425	10 lit. / 400x340x245 mm	1	2,800
221426	15 lit. / 450x350x270 mm	1	3,500
221886	20 lit. / 485x390x305 mm	1	4,050
221410	25 lit. / 520x415x330 mm	1	4,810
221446	34 lit. / 570x460x355 mm	1	5,750
221407	54 lit. / 650x520x405 mm	1	8,400

Zatka korková na demizón



kód	popis		
2210796	35 mm	1	
2210799	38 mm	1	
2210797	45 mm	1	
2210798	54 mm	1	

Zatka gumenná pre kvasný ventil



kód	popis		
2210969	40 mm	1	
2210968	50 mm	1	
2210967	60 mm	1	
2210965	65 mm	1	
2210966	75 mm	1	

Zatka kvasná



kód	popis		
2210800	plastová	1	

Mušťomer



kód	popis		
2210802	8-30% / STN 25 7619	1	

Cukromer, kvasomer



kód	popis		
2210803	0-20% / STN 25 7619	1	

Liehomer



kód	popis		
2210801	0-90%	1	

GRINDERS, CUTTERS AND PRESSES

Hadica prečerpávací



kód	popis		
2210962	10 mm, L-50 m	1	
2210805	12 mm, L-50 m	1	
2210992	16/12 mm, L-50 m	1	

Hadica prečerpávací



kód	popis		
2211019	A) 11 mm / 1.5 m / s klapkou	1	
2210806	B) 11/8 mm / 1.5 m	1	

Prečerpávač s harmonikou



kód	popis		
2210964	malý ventil	1	
2210963	veľký ventil	1	

Vrecia na zemiaky

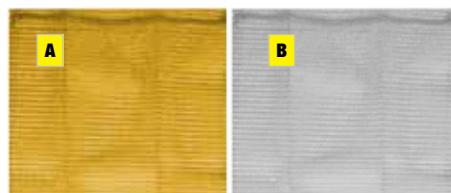

kód	popis		
217120	A) žlté 25 kg / 50x078 mm	1	
217113	B) biele 50 kg / 57x104 mm	1	

Vrecia na obilie



kód	popis		
217510	25 kg / 500x0800 mm	1	
217112	70 kg / 560x1150 mm	1	

Rezačka na kapustu



kód	popis		
221479	A) 3 nožová, 435x160 mm, ručná	1	1,000
221153	B) 3 nožová, 545 mm, malá	1	2,500
221956	B) 3 nožová, 650 mm, stredná	1	2,500
221261	B) 4 nožová, 915 mm, veľká	1	4,000

Strúhák na repu s rámom

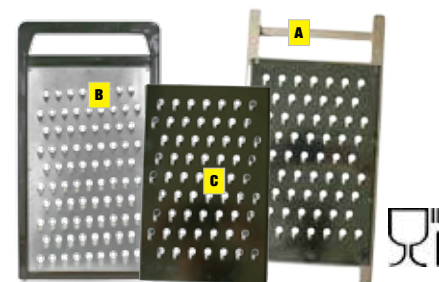

kód	popis		
211333	A) 220x440 mm, drevený	1	0,550
211355	B) 220x440 mm, plastový	1	
211367	C) náhradný plech, 210x320 mm	1	0,130

Rezačka na repu



kód	popis		
211334	rezačka	1	7,200
211344	bubon náhradný	1	1,300

Vrecia, číre



kód	popis		
217322	600x1200x0,20 mm	50	

Plnička na klobásy a jaternice



kód	popis		
2211059	ručná, objem 3 lit., 3x nástavec	1	4,750
2211061	náhradný piest silikónový	1	0,190
2211060	3x sada nástavcov, 13-17-19 mm	1	0,018

Mlynček na mäso



kód	popis		
2211036	A) 08	10	2,700
2211037	A) 10	10	3,800
2211038	B) 22	4	7,750
2211039	B) 32	2	10,000

Príslušenstvo k mlynčeku



kód	popis		
2211040	A) mriežka / pre mlynček 08 / 05 mm	1	
2211042	A) mriežka / pre mlynček 08 / 10 mm	1	
2211045	A) mriežka / pre mlynček 10 / 05 mm	1	
2211057	A) mriežka / pre mlynček 10 / 08 mm	1	
2211048	A) mriežka / pre mlynček 10 / 10 mm	1	
2211046	A) mriežka / pre mlynček 22 / 05 mm	1	
2211058	A) mriežka / pre mlynček 22 / 08 mm	1	
2211049	A) mriežka / pre mlynček 22 / 10 mm	1	
2211047	A) mriežka / pre mlynček 32 / 06 mm	1	
2211050	A) mriežka / pre mlynček 32 / 10 mm	1	
2211043	B) nôž / pre mlynček 08	1	
2211051	B) nôž / pre mlynček 10	1	
2211052	B) nôž / pre mlynček 22	1	
2211053	B) nôž / pre mlynček 32	1	
2211044	B) šnek / pre mlynček 08	1	
2211054	B) šnek / pre mlynček 10	1	
2211055	B) šnek / pre mlynček 22	1	
2211056	B) šnek / pre mlynček 32	1	

KŔmitko plastové

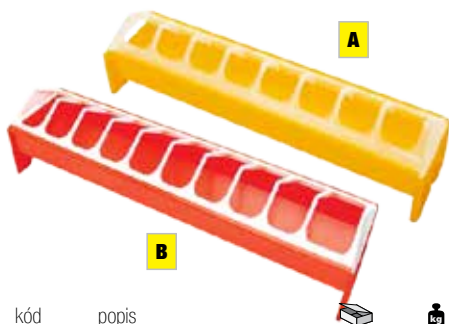

kód	popis		
2170739	A) 300 mm	1	
2170740	A) 400 mm	1	
2170741	A) 500 mm	1	
2170742	B) 500 mm	1	
2170743	B) 750 mm	1	

KŔmitko pozinkované Zn

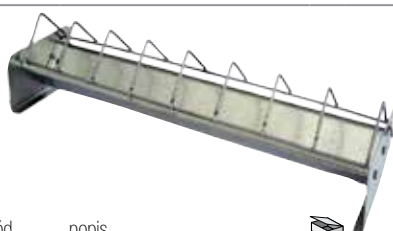

kód	popis		
211421	400 mm	1	0,500
211420	700 mm	1	0,600

KŔmitko pozinkované + 2x napájačka



kód	popis		
2170752	810x330 mm	1	

KŔmitko plastové



kód	popis		
2170744	A) 2,50 lit. / Ø210x200 mm	1	
2170745	A) 5,25 lit. / Ø280x250 mm	1	
2170746	B) 10,5 lit. / Ø390x370 mm	1	
2170747	B) 20,0 lit. / Ø420x470 mm	1	

Česák na hovädzí dobytok



kód	popis		
211002	plastová rúčka	10	0,196

KŔmitko plastové



kód	popis		
2170748	A) 15 lit. / Ø390x310 mm	1	
2170749	B) 27 lit. / Ø390x510 mm	1	

KŔmitko plastové



kód	popis		
2170738	Ø300 mm	1	

KŔmitko plastové



kód	popis		
2170750	A) 230x310 mm	1	
2170751	B) 230x310 mm	1	

KŔmitko pre zajace



kód	popis		
2170753	A) 180x260 mm	1	
2170754	B) 260x230 mm	1	

Viazak na dobytok



kód	popis		
432035	05,0 mm	1	
432042	06,0 mm	1	

Lúpač na kukuricu



kód	popis		
211071	Corny	4	7,375

Rezačka na trávu a prhľavu



kód	popis		
211105	ručná	1	

Prevodové ústrojenstvo je riešené kovovým prevodom, počet nožov: 3, priemer nožového kolesa: 270 mm

Šrotovník ručný



kód	popis		
2170960	19x32 cm	1	

2 nastaviteľné disky umožňujú nastavenie rôznej hrúbky mletia

Elektrický kladivkový šrotovník



kód	popis		
2170719	750W / granule Ø 2,5-4-6-8 mm	1	12,400
2170720	900W / granule Ø 4-6-8 mm	1	17,000
2171072	šrotovacia komora	1	0,100
2170953	sitko 1.0 mm	1	0,100
2170951	sitko 1.5 mm	1	0,100
2170947	sitko 2.5 mm	1	0,100
2170948	sitko 4.0 mm	1	0,100
2170949	sitko 6.0 mm	1	0,100
2170950	sitko 8.0 mm	1	0,100

zásobník: 44x48 cm / rozmery: 98x67 cm / nádoba: 43x35 cm

Napájačka plastová



kód	popis		
2170737	A) Ø140 mm / na PET fľašu	1	
2170758	B) 150x140x150 mm	1	

Napájačka plastová



kód	popis		
2170731	A) 6 lit. / 360x250 mm	1	
2170732	A) 9 lit. / 360x320 mm	1	
2170733	B) 12 lit. / 360x360 mm	1	

Napájačka plastová



kód	popis		
2170734	A) 6 lit. / 390x350 mm	1	
2170735	B) 12 lit. / 390x450 mm	1	
2170735	B) 16 lit. / 390x540 mm	1	

Napájačka plastová



kód	popis		
2170727	1,5 lit. / 190x160 mm	1	
2170728	3,5 lit. / 250x200 mm	1	
2170729	5,0 lit. / 250x250 mm	1	
2170730	10 lit. / 340x300 mm	1	

Napájačka, pozinkovaná

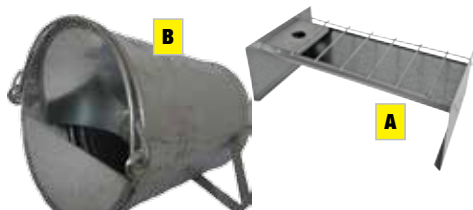

kód	popis		
211900	A) pre hydinu	1	0,670
211039	B) vedrová 10 lit. / pre dobytok	1	0,500

Napájačka plastová



kód	popis		
2170735	30 lit. / 430x720 mm	1	

Napájačka s napájačom



kód	popis		
2170724	A) napájač 45° / Ø12x11x10 cm / 500 ml	1	
2170725	A) napájač 45° / Ø12x11x19 cm / 1 lit.	1	
2170722	B) napájač 90° / Ø12x11x10 cm / 500 ml	1	
2170723	B) napájač 90° / Ø12x11x19 cm / 1 lit.	1	

Napájač k napájačkam



kód	popis		
2170815	1 ks	1	
2170726	bal. 120 ks	120	

Napájačky pre zajace



kód	popis		
2170755	A) 60x110x220 mm	1	
2170756	B) 60x110x220 mm	1	
2170964	C) 60x110x220 mm / Zn+PVC	1	

Analógová liaheň, manuálna

Manuálne otáčanie (na slepačie vajcia), teplomer, vlhkomer, zvonka plniteľná nádrž na vodu. Teplota je nastaviteľná (továrnske nastavenie 37,8 - 38,5°C). Mriežka na vajcia v dolnej časti.



kód	popis		
2170524	Prikon 110W / 41-64 ks vajec	1	
2170525	Prikon 110W / 80-120 ks vajec	1	

Vyhrievacie lampy



kód	popis		
2170761	A) 100W / Ø160x390 mm / kábel 2,5 m	1	
Vhodné pre cca. 20/30 kurčiat			
2170760	C) 250W / Ø230x490 mm / kábel 2,5 m	1	
Regulátor. Vhodné pre cca. 100/200 kurčiat alebo 6/12 ošípaný			
2170759	C) 250W / Ø230x490 mm / kábel 2,5 m	1	
Vhodné pre cca. 100/200 kurčiat alebo 6/12 ošípaný			

Analógová liaheň, manuálna



kód	popis		
2170818	Prikon 180W / 550x420x580 mm	1	
230V, 50Hz. Priemerná spotreba je 2,4kWh/24hod. Tento inkubátor je vybavený aj dvoma špeciálnymi kontajnermi - podnosmi s posuvným dnom a prestaviteľnými prepážkami pre umiestnenie vajec akejkoľvek veľkosti. Všetky vajíčka sa otáčajú niekoľkokrát za deň jediným pohybom ruky. Orientačný počet vajíčok: slepičky 108, kačky 80, morka 64, hus 30, perlička 120, bažant 120. Ohrev liahne je riešený dvoma vyhrievacími káblami v silikónovej izolácii na rámečku v hornej a spodnej časti liahne. Ventilátor, ktorý je umiestnený v hornej časti liahne zaisťuje prúdenie vzduchu, dobré odvetrávanie a jednotnosť teploty a vlhkosti v celom priestore liahne. Teplota termostatu je prednastavená na 37,8 stupňov Celzia. Maximálna spotreba 195 kWh.			

Liaheň, manuálna



kód	popis		
2170818	A) Prikon 80W / 580x410x375 mm	1	
Analogová. Zmestí sa do nej až 54 násadových slepačích vajec. Pokročilá elektronická výbava umožňuje vyhrievanie, vlhkosť a ventiláciu. Otáčanie manuálne - jedným potiahnutím za páčku dva krát za deň.			
2170817	B) Prikon 80W / 580x410x375 mm	1	
Digitálna. Zmestí sa do nej až 54 násadových slepačích vajec. Pokročilá elektronická výbava umožňuje vyhrievanie, vlhkosť a ventiláciu. Otáčanie manuálne - jedným potiahnutím za páčku dvakrát za deň. Inovačný digitalizovaný systém zjednodušuje všetky procesy (nastavenie počtu dní a teploty a navyše upozorňuje aj na potrebu doplniť vodu do nádrže)			

BARELY A NÁDOBY

Barel, sud plastový na dažďovú vodu



kód	popis		
254375	A) 120 lit., 395 mm	1	3,850
254377	B) 120 lit., 395 mm, so závitom	1	4,650
254430	C) veko na barel	1	4,650
254499	D) obruč na barel	1	

Barel, sud plastový



kód	popis		
254373	A) 30 lit., 278 mm	1	1,100
254372	B) 30 lit., 250 mm	1	1,390
254394	B) 60 lit., 250 mm	1	2,090

Sud na kapustu, keramický



kód	popis		
254099A	A) 05 lit.	1	
254100A	A) 10 lit.	1	
254102A	A) 17 lit.	1	
254103A	A) 20 lit.	1	
254104A	A) 27 lit.	1	
254105A	A) 30 lit.	1	
254107A	A) 40 lit.	1	
254214	B) vrchnák, 05 lit.	1	
254490	B) vrchnák, 10 lit.	1	
254215	B) vrchnák, 17-27 lit.	1	
254216	B) vrchnák, 30-40 lit.	1	
254516	C) ťažítka, 05-08 lit.	1	
254066	C) ťažítka, 10-25 lit.	1	
254518	C) ťažítka, 17-27 lit.	1	
254519	C) ťažítka, 30-40 lit.	1	

Barel, sud plastový na kvasenie



kód	popis		
254393	030 lit., 253 mm	1	1,500
254374	060 lit., 325 mm	1	2,500
254403	120 lit., 395 mm	1	3,250
254378	220 lit., 471 mm	1	8,150
254499	obruč na barel 120 lit.	1	

Barel širokohrdlý



kód	popis		
254112	A) 20 lit	1	0,825
254114	A) 30 lit	1	1,100
254113	A) 50 lit	1	1,950
254388	B) 50 lit., 115 mm	1	1,780
254395	B) 50 lit., 200 mm	1	2,040

Sud, PVC • dvojhrdlový



kód	popis		
254098	40 lit	1	2,000
254093	50 lit	1	2,270

Nádoba na potravinárske účely



kód	popis		
254157	275 lit., 110x35 cm	1	

Nádoba na potravinárske účely



kód	popis		
254500	100 lit., 71x39 cm	1	3,900

Nádoba na potravinárske účely



kód	popis		
254344	65 lit	1	2,425

Nádoba na potravinárske účely



kód	popis		
254340	035 lit, ø 41 cm, výška 36 cm	1	1,500
254134	050 lit, ø 41 cm, výška 49 cm	1	2,050
254014	075 lit, ø 44 cm, výška 63 cm	1	2,500
254264	100 lit, ø 53 cm, výška 66 cm	1	3,000
254263	120 lit, ø 53 cm, výška 79 cm	1	4,650
254392	veko na nádobu / 35-50 lit.	1	0,400
254261	veko na nádobu / 75 lit.	1	0,500
254260	veko na nádobu / 100-120 lit.	1	1,000

Nálevka



kód	popis		
254289	1 lit	1	0,134
254290	3 lit	1	0,240

BARELS AND PVC CONTAINERS

Nádoba Ecotank s vekom a ventilom



kód	popis		
254452	200 lit. / 070 cm	1	
254453	300 lit. / 083 cm	1	
254454	500 lit. / 103 cm	1	

Nádoba Ecotank



kód	popis		
254278	210 lit.	1	5,300
254309	300 lit.	1	7,300
254338	500 lit.	1	11,00
254318	veko 078 cm pre 210 a 300 lit.	1	1,000
254416	veko 096 cm pre 500 lit.	1	3,000
254310	podstavec po nádobu 210-300 lit.	1	1,000

Ventil k nádobe Ecotank

A	B		
kód	popis		
254311	A) 3/4"	50	0,040
254485	B) 1"	1	0,100
254486	B) 1,2"	1	0,100

Stojan na fľaše

kód	popis		
217888	6 fľaš na polici	1	0,580

Nádoba perforovaná



kód	popis		
254285	25 lit, 40 cm	1	1,100
254495	32 lit, 44 cm	1	
254286	40 lit, 47 cm	1	1,650
254287	50 lit, 50 cm	1	1,750
254345	65 lit, 55 cm	1	
254432	70 lit, 55 cm	1	
254346	100 lit, 60 cm	1	
254347	125 lit, 65 cm	1	
254470	130 lit, 70 cm	1	
254348	155 lit, 75 cm	1	

Nádoba perforovaná

kód	popis		
254349	210 lit, 80 cm	1	5,700

Nádoba s ušami

kód	popis		
254270	30 lit., ø 45 cm, výška 37 cm	1	1,000
254272	65 lit., ø 55 cm, výška 44 cm	1	2,250

Košík na ovocie

kód	popis		
254328	A) ručka na košík	1	0,090
254327	A) 20 lit, LLDPE	1	0,760
254331	B) 16 lit	1	1,000

Nádoba na kvasenie



kód	popis		
254247	0230 lit, ø 86 cm, výška 56 cm	1	6,800
254007	0350 lit, ø 90 cm, výška 72 cm	1	9,500
254248	0500 lit, ø 102 cm, výška 90 cm	1	11,000
254330	0750 lit, ø 122 cm, výška 82 cm	1	17,000
254301	1000 lit, ø 150 cm, výška 100 cm	1	25,500
254307	1500 lit, ø 155 cm, výška 100 cm	1	44,500
254404	veko / 0500 lit., 104 cm	1	3,000
254405	veko / 0750 lit., 122 cm	1	4,000
254406	veko / 1000 lit., 140 cm	1	6,000

Prepravky

kód	popis		
254506	45 lit. / 58x38x31,5 cm	1	
254507	45 lit. / 58x38x31,5 cm	1	

Skladovateľné a stohovateľné

Prepravky

kód	popis		
254418	A) 40 lit. / 56x35x31 cm	1	1,550
254419	B) 40 lit. / 56x35x31 cm	1	1,450
254420	C) 40 lit. / 56x35x31 cm	1	1,400

Skladovateľné a stohovateľné

Koš na fľaše

kód	popis		
2210474	6 fľaš	1	0,320

Lampička solárna



kód	popis		
2170050	410 mm / 1xLED / SS	1	0,362

Lampička solárna



kód	popis		
2170130	340 mm / 2xLED / SS	24	0,105

Lampička solárna



kód	popis		
2170484	12x15x13 cm / 3xLED / AA	12	0,175

Lampička solárna



kód	popis		
2170486	11x4,5x11 cm 2xLED / AA / bal. 12ks	12	0,175

Lampička solárna



kód	popis		
2170049	A) 140 mm / 3xLED	1	0,267
2170209	B) 190 mm / 1xLED / PR / 1xAAA	12	0,583
2170211	C) 78 mm / 1xLED / GS / 1xAAA	6	0,416

Lampička solárna



kód	popis		
2170139	A) 385 mm / 2xLED / 1xAAA	12	
2170140	B) 520 mm / super jasné LED svetlo 20lm / 1xAAA	12	

Lampička solárna



kód	popis		
2170213	A) 270 mm / 2xLED / PP	2	0,133
2170214	B) 270 mm / 2xLED / SS+PP	2	0,150

Lampička solárna



kód	popis		
2170128	355 mm / 2xLED / SS	36	0,081

Lampička solárna

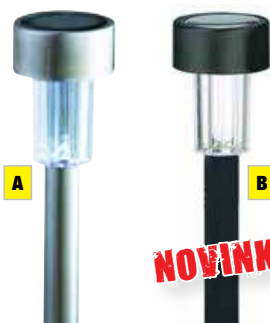

kód	popis		
2170051	A) 363 mm / 2xLED / SS	24	0,133
2170013	B) 310 mm / 1xLED	24	

Lampička solárna

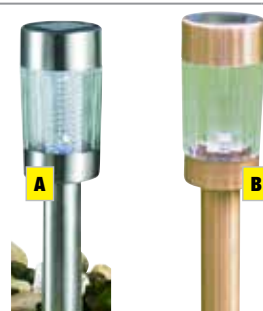

kód	popis		
2170138	A) 380 mm / 2xLED / 1xAAA	12	
2170129	B) 427 mm / 2xLED / SS+PP	24	0,164

Žiarovka solárna Becrux



kód	popis		
2170938	5,5x10 cm, 1xLED, farebná balenie 24ks	24	

Žiarovka solárna **NOVINKA**



kód	popis		
2171097	9x18 cm / 5xLED / 1x AAA Ni-MH / 4 hod. časovač / balenie 24ks	24	

Žiarovka solárna



kód	popis		
2170937	7,5x22 cm / 4xLED biela / číra balenie 24ks	24	

LED sviečka



kód	popis		
2170185	A) 72x120 mm, batéria 2xC balenie bez batérie, LED žltá	1	0,110
2170186	B) 60x103 mm, batéria 2xC balenie bez batérie, LED žltá	1	0,113
2170187	C) 61x104 mm, batéria 2xC balenie bez batérie, LED žltá	1	0,265

Lampička solárna

NOVINKA



kód	popis		
2170497	10x34 cm / 1xLED / 1xAAA	12	

Lampa, rôzne farby



kód	popis		
2170483	85 cm / 1xLED / AA	12	0,175

Lampička solárna



kód	popis		
2170485	900 mm / 1xLED multicolor / AA	12	0,175

Lampička solárna



kód	popis		
2170210	A) 450 mm / 1xLED / GS / 1xAAA	6	0,642
2170212	B) 385 mm / 2xLED / PP / 1xAAA	24	0,175

Lampička solárna

NOVINKA



kód	popis		
2171104	7x35 cm / 2xLED / 1xAAA	1	

Solárne lampióny



kód	popis		
2171107	Ø 8 cm / 10xLED / studena biela / dĺžka reťaze: 1,5 m	1	

Lampička solárna



kód	popis		
2170053	360 mm / 2xLED / PP	20	0,229

Lampička solárna

NOVINKA



kód	popis		
2171105	6x39 cm / 2xLED / 1xAAA	12	

Lampička solárna



kód	popis		
2170209	190 mm / 1xLED / PR / 1xAAA	12	0,583

Lampička solárna



kód	popis		
2170487	420 mm / 5xLED / AA	24	0,175

Lampička solárna

NOVINKA



kód	popis		
2171106	8x11 cm / 1xLED / 1xAAA	12	

ZÁHRADA

GRILY A KRBOVÉ PODPAĽOVAČE

Gril Porter



kód	popis		
2210240	112x63x117 cm	1	20,000

Teplomer. Odkladacia plocha. Koleska uľahčujúce transport. Ohniska. Odťah dymu. Veľkosť grilovacej plochy: 60 x 26,5 cm. Vyrobené zo žiaruvzdornej ocele. 2 komory. Nastaviteľné ventilačné záklopy

Gril Dexter



kód	popis		
2210290	95x115x67 cm	1	18,000

Koleska uľahčujúce transport.

Plynový gril Madeira



kód	popis		
2210521	výkon 3.5 kW	1	18,700

Povrchová úprava roštu - niklovaná. / Spotreba (g/hod) : 330
Rozmery (š x h x v) : 470x285x830 / bez regulátora a hadice!!

Gril BBQ Diplomat



NOVINKA

kód	popis		
2210293	plynový, 3 horáky +1 bočný horák	1	

Výkon: 13.8 kW / Spotreba: 1003 g/hod. / 132x57x119 cm
1 smaltovaný liatinový rošt, 1 liatinová platňa, teplomer

Gril Oliver



kód	popis		
2210583	540x570x920 mm	1	
2211105	rošt náhradný ku grilu	1	
221235	rúčka náhradná	1	

Gril Granada



kód	popis		
2210582	52.5x32.5x84 cm	1	4,600

Gril jednorazový



kód	popis		
2211072	290x240x50 mm	1	

Kvalitné hliníkové puzdro obsahuje uhlie napustené horľavou látkou, stačí zapáliť zápalkou, obsahuje odnímateľný podstavec.

Gril Capri, nerezový



kód	popis		
221180	400x680 mm	1	

nastaviteľná výška grilu / regulácia prívodu vzduchu pomocou páčky

Gril Globus



kód	popis		
2210581	470x450x720 mm	1	5,400
221236	rošt náhradný ku grilu	1	
221237	rúčka náhradná	1	

Gril Andalusia



kód	popis		
2210517	370x450 mm	1	4,000

Gril Caorle



kód	popis		
2210514	370x450	1	1,080

GRILLS AND FIREPLACE LIGHTERS

Grilovacie misky a pekáče



kód	popis		
2212040	A) miska 350x240 mm / 3ks	1	
2212041	A) pekáč 320x260 mm / 3ks	1	
2212038	B) miska 340 mm / 3ks	1	

Grilovacie misky



kód	popis		
2212039	320 mm / 4ks	1	

Grilovací alobal



kód	popis		
217800	30 cm / návin 10 m	1	
217951	45 cm / návin 10 m	1	

Grilovacie uhlie a brikety



kód	popis		
221987	A) brikety 2,5kg	1	2,500
221099	B) uhlie 2,5kg	1	2,500

Zápalky krbové



kód	popis		
217461	A) 500 kúsov / v dóze	1	0,900
217460	B) 40 kúsov / 150 mm	1	0,200
217457	B) 10 kúsov / 200 mm	1	0,100

Zápalky krbové



kód	popis		
2170944	A) Medium / bal. 100 ks	1	
2170945	B) Large / bal. 40 ks	1	
2170946	C) XLarge / bal. 40 ks	1	

Zápalky krbové



kód	popis		
2170943	XXLarge / 280 mm / bal. 40 ks	1	

Komínček



kód	popis		
217492	odstraňovač sadzí, 5 ks	20	0,100

Drevný podpaľovač



kód	popis		
2171069	100 ks, drevený podpaľovač	1	
217346	1 liter, tekutý podpaľovač	8	0,880

Čistiace prostriedky



kód	popis		
2170008	A) 500 ml, na gril, opekacie zariadenia	8	0,600
217945	B) 500 ml, na krb, gril, kachle, rúry	8	0,600

Lampový olej



kód	popis		
217477	A) citrónela, 1 lit.	8	0,900
217946	B) číry, 1 lit.	8	0,880
217938	C) vanilka, 1 lit.	8	0,900
217939	D) zelené jablko, 1 lit.	8	0,930
217446	E) dušičkový, 500 ml	8	0,467

Gélový podpaľovač



kód	popis		
217347	A) 500 ml	8	0,490
217476	B) 1 liter	8	0,900

Podpaľovače



kód	popis		
217471	A) 40 kúsov / PE-PO	30	0,290
217475	B) drevený, 20 kúsov	15	0,360
2170009	C) drevený, 32 kúsov	30	0,130

Čistiace poleno



kód	popis		
2171071	950 g, balenie obsahuje 2 podpaľovače	1	

Katalyzátor, odstraňovač sadzí



kód	popis		
2170957	500g	1	
2170958	1000 g	1	

GRILOVACIE NÁRADIE

Sada náradia v kufriku



kód	popis		
2212061	235x80x485 mm	1	2,100
1ks Vidlička / 1ks Kliešte / 1ks Obracačka / 1ks Nôž veľký / 6ks Malý nôž / 6ks Malá vidlička			

Sada náradia



kód	popis		
2210365	z tvrdého dreva / 18 dielna	4	3,375

Sada náradia



kód	popis		
2210443	z tvrdého dreva / 10 dielna	8	2,063

Sada náradia



kód	popis		
2210449	A) rúčky z tvrdého dreva	12	0,500
2210444	B) dubové rúčky	1	1,250

Sada ihlic



kód	popis		
2210440	A) 6ks	25	0,272
2210441	B) 6ks	20	0,215
2210442	C) 4ks	40	0,120
2210972	D) 6 ks	1	

Obracač



kód	popis		
2210450	nerezový	20	0,335

Panvica grilovacia



kód	popis		
2212062	320x40 mm / odnímateľná rúčka	1	

Opekač



kód	popis		
2210973	310x130 mm	1	

Opekač



kód	popis		
2210976	170x83 mm	1	

Bodec na opekanie

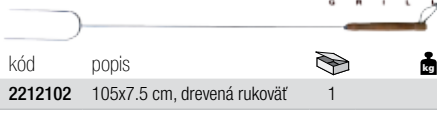

kód	popis		
2212102	105x7.5 cm, drevená rukoväť	1	

Rošt

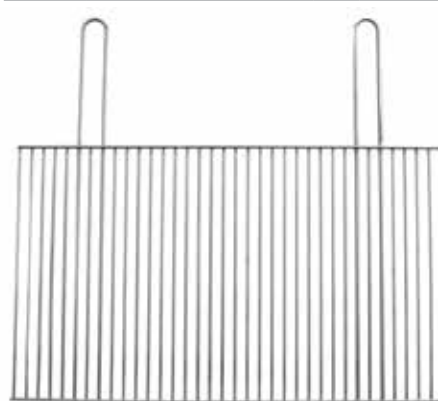

kód	popis		
2210282	680x400 mm	1	
2210279	570x300 mm	1	
2210280	600x400 mm	1	
2210975	850x400 mm	1	

Rošt



kód	popis		
2210977	380x680 mm	1	
2210978	380x580 mm	1	
2210979	380x480 mm	1	

Opekač



kód	popis		
2210974	275x280 mm	1	

Opekač

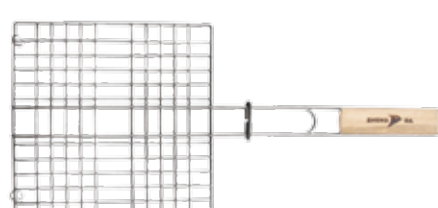

kód	popis		
2210438	220x220 mm	1	

GRILL SETS

Kefa BARBECUE



kód	popis		
253551	533 mm so škrabkou	12	0,237

Kefa BARBECUE



kód	popis		
253173	300 mm	12	0,146

Kefa BARBECUE



kód	popis		
253553	457 mm	12	0,111

Kefa BARBECUE



kód	popis		
253552	mosadzná so škrabkou	12	0,250

Rukavice



kód	popis		
312329	100% bavlnená podšívka	1	

Digitálny vydlicový tester



kód	popis		
222590	zobrazuje aktuálnu teplotu jedla	1	

Fúkací mech



kód	popis		
2210791	40x17 cm	1	1,040

Dúchadlo mechanické



kód	popis		
2210289	plastové	1	

Nôž rybársky



kód	popis		
2170557	250 mm	1	

Nôž rybársky



kód	popis		
2170554	270 mm	1	

Nôž hubársky



kód	popis		
2170556	140/210 mm	1	

Nôž skladací



kód	popis		
2170555	130/225 mm	1	

Nôž skladací



kód	popis		
2170558	115/210 mm	1	

Nôž skladací



kód	popis		
2170559	115/200 mm	1	

Nôž skladací s LED



kód	popis		
2170560	60/103 mm	1	

Otvárač univerzálny



kód	popis		
2210994	3v1	1	

Nôž multifunkčný

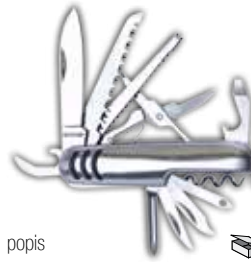

kód	popis		
2170563	15v1	1	

Nožnice multifunkčné



kód	popis		
2170553	3v1, 210 mm	1	

Sada nožníc na papier



kód	popis		
211488	140, 215, 245 mm	6	0,183

Nožnice na papier



kód	popis		
2160263	180 mm	36	0,070

Ostrič nožov



kód	popis		
2210995	140 mm	1	

ZÁHRADNÉ SETY, STOLI, LAVICE A STANY

Záhradná stolička a stôl



kód	popis	kg
802138	A) stolička Karen 70x55x90 cm	1
802139	B) stôl Gregory 80x140x70 cm / hrúbka kovu 34x14x1 mm	1
802219	C) stolička 55x70x105 cm / šedá / polohovateľna do 7 polôh	1
802220	D) stolička 55x70x105 cm / limetka / polohovateľna do 7 polôh	1
802218	E) stôl 60x72 cm / sklo	1

Set terasový Celinda, ratan



kód	popis	kg
802051	stôl 90x90x72 cm / 4x stolička 56x58x87 cm	40,000
802061	stôl 90x90x72 cm	1
802062	stolička 56x58x87 cm	1

Set záhradný Leticia



kód	popis	kg
802099	šedý / stôl 85x71 cm 4x stolička 74x53x91 cm 1x dáždnik Ø180 cm	1

Set balkonový Alesia



kód	popis	kg
802050	stôl 70x60 cm / 2x stolička 52x55x73 cm	12,160
802056	stôl 70x60 cm	1
802055	stolička 52x55x73 cm	1

Set balkonový Brenda



kód	popis	kg
802097	set modrý / stôl 72x59 cm / 2x stolička 60x71 cm	1
802098	set zelený / stôl 72x59 cm / 2x stolička 60x71 cm	1
802217	1x stôl 72x59 cm / sklo	1
802134	1x oranžová stolička 60x71 cm	1
802135	1x fialová stolička 60x71 cm	1
802136	1x šedá stolička 60x71 cm	1
802137	1x zelená stolička 60x71 cm	1
802125	1x modrá stolička 60x71 cm	1

Set záhradný Gardenia



kód	popis	kg
802088	zelený / stôl 60x70 cm / 2x stolička 46x56x85 cm	1
802089	oranžová / stôl 60x70 cm / 2x stolička 46x56x85 cm	1

TERASOVÉ SETY

Set terasový Cayman



kód	popis		
802276	1x stůl 40x80x60 cm / 2x stolička 65x70x80 cm, Moca hnědá	1	
802280	kreslo	1	
802279	poduška hnědá, 6 cm	1	
802293	poduška béžová, 6 cm	1	

Set terasový Cayman



kód	popis		
802282	1x stůl 40x80x60 cm / 2x stolička 65x70x80 cm, Moca béžová	1	
802280	kreslo	1	
802279	poduška hnědá, 6 cm	1	
802293	poduška béžová, 6 cm	1	

Set terasový Antigua



kód	popis		
802277	1x stůl 40x80x60 cm / 2x kreslo 65x70x80 cm / 1x dvojkreslo 120x70x80 cm / Moca hnědá	1	
802280	kreslo	1	
802279	poduška hnědá, 6 cm	1	
802293	poduška béžová, 6 cm	1	

Set terasový Antigua



kód	popis		
802290	1x stůl 40x80x60 cm / 2x kreslo 65x70x80 cm / 1x dvojkreslo 120x70x80 cm / Moca béžová	1	
802280	kreslo	1	
802279	poduška hnědá, 6 cm	1	
802293	poduška béžová, 6 cm	1	

Set terasový Bahama



kód	popis		
802278	1x stůl 40x80x60 cm / 2x kreslo 65x70x80 cm / 1x trojkreslo 175x70x80 cm / Moca hnědá	1	
802280	kreslo	1	
802279	poduška hnědá, 6 cm	1	
802293	poduška béžová, 6 cm	1	

Set terasový Bahama



kód	popis		
802291	1x stůl 40x80x60 cm / 2x kreslo 65x70x80 cm / 1x trojkreslo 175x70x80 cm / Moca béžová	1	
802280	kreslo	1	
802279	poduška hnědá, 6 cm	1	
802293	poduška béžová, 6 cm	1	



TABLES, BENCHES AND TENS

Stôl a lavica, PVC/kov, skladacie

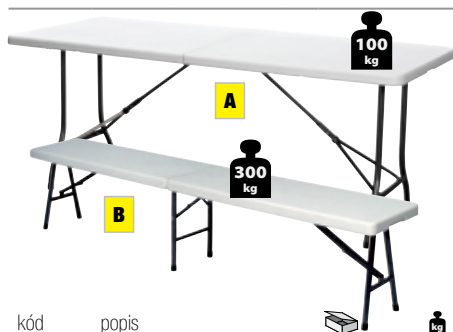

kód	popis	1	kg
A) Stôl 802005	otvorený 183x76x72 cm zložený 91,5x76x8,0 cm	1	14,500
B) Lavica 802008	otvorený 183x30x43 cm zložený 91,5x30x10 cm	1	9,600

Stôl skladací, PVC/kov

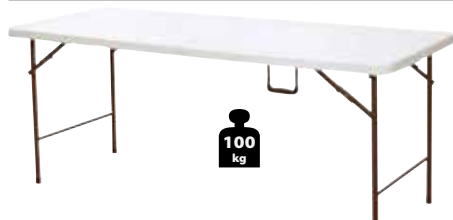

kód	popis	1	kg
802022	otvorený 152x70x73,5 cm zložený 76x70x8,0 cm	1	11,500

Stôl skladací, PVC/kov

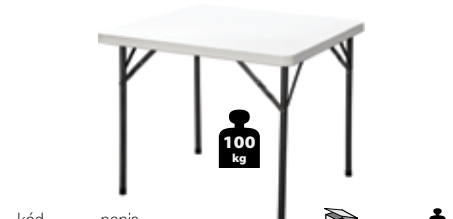

kód	popis	1	kg
802023	otvorený 88x88x74 cm zložený 88x88x4,5 cm	1	9,500

Stôl skladací, PVC/kov



kód	popis	1	kg
802025	otvorený Ø160x75 cm zložený Ø160x9,0 cm	1	19,500

Stolička skladacia, PVC/kov



kód	popis	1	kg
802024	otvorený 56x48x86 cm zložený 111x48x17,5 cm	1	4,500

Stan Elvis



kód	popis	1	kg
802065	červený, 300x600 cm	1	
802064	modrý, 300x600 cm	1	
802087	zelený, 300x600 cm	1	
802069	stena červená, 300x600 cm	1	
802119	stena zelená, 300x600 cm	1	
802068	stena modrá, 300x600 cm	1	
802199	Plátno na strechu červené	1	
802197	Plátno na strechu modré	1	
802198	Plátno na strechu zelené	1	

Pivný set, 2x lavica a 1x stôl



kód	popis	1	kg
802027A	stôl 175x46x76.5 cm lavica 175x23x47 cm; 3x noha drevo 25 mm	1	8,330
802028A	stôl 200x50x77 cm lavica 200x25x47 cm; 3x noha drevo 27 mm	1	9,630
802033	noha náhradná kovová	1	

Súprava podušiek na pivný set



kód	popis	1	kg
802034	175x25x2cm	1	
802035	200x25x2cm	1	
802036	220x25x2cm	1	

Obsahuje: 2 kusy vankúšov, 1 kus obrus
Materiál: 50% bavlna + 50% polyester
Výplň: 100% polyuretánová pena

Noha lavičková, konštrukčný diel

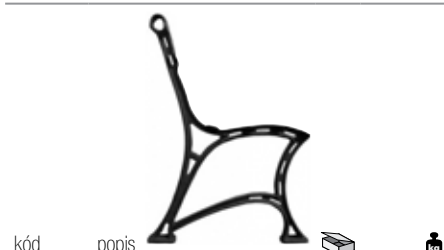

kód	popis	1	kg
2170174	740x510 mm / lakovaný hliník	1	

Stan Clinton



kód	popis	1	kg
802292	zeleno-biely / 3x3x2,5 m / kov Ø 25x19 mm	1	
802092	biely / 3x3x2,5 m / kov Ø 25x19 mm	1	

Záhradný stan Festival



kód	popis	1	kg
802090	bez steny / modrý / 3x3 m	1	16,000
802224	bez steny / zelený / 3x3 m	1	16,000
802225	bez steny / červený / 3x3 m	1	16,000
802091	stena modrá	1	
802226	stena zelená	1	
802227	stena červená	1	
802229	strecha modrá	1	
802230	strecha zelená	1	
802228	strecha červená	1	

Materiál: 420D Oxford (230g PES) potiahnutý PVC. Vodeodolný a odolný UV žiareniu. Rám: oceľový, biely

Záhradný stan Montgomery



kód	popis	1	kg
802057	AZZURRO / modrý / 3x3 m	1	16,000
802066	ROSSI / červený / 3x3 m	1	16,000
802086	VERDE / zelený / 3x3 m	1	16,000
802075	Plátno na strechu modré	1	
802196	Plátno na strechu červené	1	
802075	Plátno na strechu modré	1	
802195	Plátno na strechu zelené	1	
802063	Stena modrá	1	
802118	Stena zelená	1	
802067	Stena červená	1	

ZÁHRADNÝ DREVENÝ NÁBYTOK

Set terasový LEQ Maribo



150 kg

NOVINKA

kód	popis		
802294	6x stolička 55x60x85 cm 1x stôl 135x75x72 cm drevo Meranti	1	
802240	stolička s opierkou 55x60x85 cm / nosnosť 150kg / drevo Meranti	1	
802239	stôl 135x75x72 cm / drevo Meranti	1	

Set terasivý LEQ Guldborg



150 kg

NOVINKA

kód	popis		
802295	4x stolička 46x58x87 cm 1x stôl 90x90x72 cm drevo Meranti	1	
802245	stolička 46x58x87 cm / nosnosť 150kg / drevo Meranti	1	
802241	stôl 90x90x72 cm / drevo Meranti	1	

Set balkonový LQ Kolding



NOVINKA

150 kg

kód	popis		
802242	2x stolička 90x60x65 cm 1x stôl 60x45x55 cm drevo Meranti	1	

Lehátko LQ Langeland



250 kg

NOVINKA

kód	popis		
802247	196x71x28/81 cm / drevo Meranti	1	

Záhradná lavička



kód	popis		
802026	122x54x73 cm drevo / plast / liatina	1	15,500

Podložka LQ HOBRO



NOVINKY

kód	popis		
802244	39x36x2 cm, krémová	1	
802243	39x36x2 cm, zelená	1	

Záhradná lavička



kód	popis		
802031	120x41x82 cm ocel / plast	1	15,500

Záhradná lavička



kód	popis		
802029	123x54x77 cm drevo / liatina	1	21,000



Stolička skladacia, detská



St Leisure Equipment **60 kg**

kód	popis	1
802152	35x35x55 cm, kov Ø 13x0,7 mm	1

Stolička skladacia, detská



St Leisure Equipment **60 kg**

kód	popis	1
802153	35x35x55 cm, kov Ø 13x0,7 mm	1

Stolička skladacia, detská



St Leisure Equipment **60 kg**

kód	popis	1
802154	35x35x55 cm, kov Ø 13x0,7 mm	1

Stolička skladacia, detská



St Leisure Equipment **60 kg**

kód	popis	1
802155	35x35x55 cm, kov Ø 13x0,7 mm	1

Stolička skladacia



St Leisure Equipment **120 kg**

kód	popis	1
2170606	zelená / 53x53x90 cm / 120kg	1
2170607	modrá / 53x53x90 cm / 120kg	1

Stolička skladacia



St Leisure Equipment **120 kg**

kód	popis	1
802145	85x50x85 cm	1

Stolička skladacia



St Leisure Equipment **80 kg**

kód	popis	1
802144	30x40 cm	1

Stolička skladacia s taškou



St Leisure Equipment **80 kg**

kód	popis	1
2170564	250x270x320 mm / max. 150kg	1

Stolička skladacia Leon



St Leisure Equipment **120 kg**

kód	popis	1
802142	oranžová / 80x80x75 cm	1
802143	modrá / 80x80x75 cm	1

Mini stolička skladacia s taškou



St Leisure Equipment **80 kg**

kód	popis	1
802037	200x250x470 mm	1
802030	270x270x470 mm	1

Stolička záhradná, skladacia



St Leisure Equipment

kód	popis	4	3,500
221913	470x600 mm	4	3,500

Podložka Mitch



St Leisure Equipment

kód	popis	1
802117	130x170 cm, PE	1

Box uložený



NOVINKA

kód	popis	1
254522	A) 119x48x60 mm / antracit	1
254523	B) 119x48x60 mm / antracit	1

Lehátko Grenada

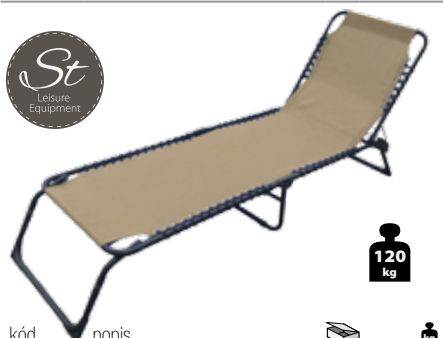

kód	popis	1	kg
802194	190x25x65 cm, kov Ø 22x1 mm	1	120

Plážová podložka Dominica

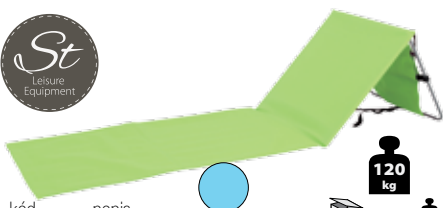

kód	popis	1	kg
802140	modrá, 150x50 cm, kov Ø 13 mm	1	120
802160	zelená, 150x50 cm, kov Ø 13 mm	1	120

Lehátko Panama

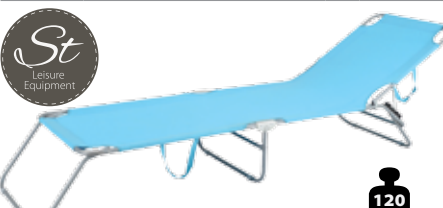

kód	popis	1	kg
802141	190x55x30 cm, kov Ø 22x1 mm	1	120

Lehátko Cuba



kód	popis	1	kg
802146	oranžové 140x60x96 cm	1	120
802147	zelené 140x60x96 cm	1	120
802148	modré 140x60x96 cm	1	120

Lehátko Barbados



kód	popis	1	kg
802149	zelené 56x85x90 cm	1	80
802150	modré 56x85x90 cm	1	80

Lehátko Havana



kód	popis	1	kg
802151	165x70x110 cm, kov Ø 22x1 mm	1	120

Lehátko Jamaica



kód	popis	1	kg
802100	modré, 140x60x96 cm	1	120
802101	oranžové, 140x60x96 cm	1	120
802096	šedé, 140x60x96 cm	1	120
802095	zelené, 140x60x96 cm	1	120

Lehátko Belize



kód	popis	1	kg
802093	modré, 188x56x33 cm	1	120
802094	zelené, 188x56x33 cm	1	120

Kotva zemná na ukotvenie

- 1 Zemná kotva
- 2 Krúžok so závitom
- 3 Sklopné úchytky
- 4 Poistka

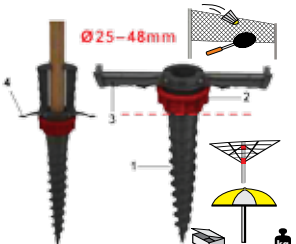

kód	popis	12	1,375
2170097	25 - 48 mm	12	1,375

Pomocou tejto kotvy na stĺpy môžete upevniť veľké i malé slnečníky, stany, športové siete a iné bez použitia betónu

Lehátko Carolina



kód	popis	1	kg
802221	175x65x115 cm / kov / šedá	1	120

Stan plážový Cartagena

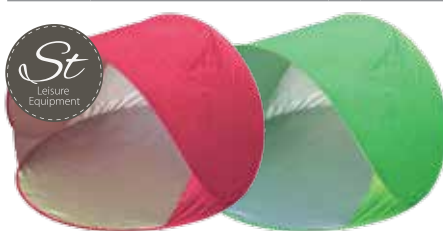

kód	popis	1	kg
802158	červený / 1,5x0,85 m materiál: textil 190T	1	120
802159	zelený / 1,5x0,85 m materiál: textil 190T	1	120

Stan plážový Corinto



kód	popis	1	kg
802156	2x1,2x1 m materiál: fiberglass, polyester, PE	1	120

Stan plážový Chico



kód	popis	1	kg
802157	2,2x1,2x1,2 m materiál: fiberglass, polyester, PE	1	120

Snečník Eugenia



Výber farieb nie je možné ovplyvniť!



kód	popis		
802185	Ø 180 cm; tyč 19/22 mm rebrá: Ø 2,7 mm materiál: oceľ, nylon (potlač) bez náklonu mix farieb	1	

Snečník Cerys



Výber farieb nie je možné ovplyvniť!



kód	popis		
802184	Ø 180 cm; tyč 19/22 mm rebrá: Ø 2,7 mm materiál: oceľ, pevný nylon bez náklonu mix farieb	1	

Snečník Willa



Výber farieb nie je možné ovplyvniť!



kód	popis		
802186	Ø 180 cm; tyč 22/25 mm rebrá: Ø 3 mm materiál: oceľ, polyester 140g s oceľovým náklonom mix farieb	1	

Snečník Libby s UV ochranou



Výber farieb nie je možné ovplyvniť!



kód	popis		
802187	Ø 180 cm; tyč 32/32 mm rebrá: Ø 3 mm materiál: oceľ, polyester 140g (potlač) plastový náklon mix farieb	1	

Snečník Tammy



Výber farieb nie je možné ovplyvniť!



kód	popis		
802188	Ø 230 cm; tyč 28/32 mm rebrá: Ø 3 mm materiál: oceľ, polyester 140g s oceľovým náklonom mix farieb	1	

Snečník Zoe



kód	popis		
802189	Ø 230 cm; tyč 34/34 mm rebrá: Ø 8x16 mm materiál: oceľ, polyester 160g s vetracím otvorom; s kľúčkou bez náklonu; bez klapiek	1	

Snečník Waikiki



NOVINKA

Výber farieb nie je možné ovplyvniť!



kód	popis		
802248	Ø 180 cm; tyč 22 mm materiál: kov, nylon mix farieb	1	

Snečník Demi



kód	popis		
802190	béžový	1	14,000
802211	zelený	1	14,000

Ø 300 cm; tyč 48/42 mm
rebrá: Ø 12x18 mm
materiál: oceľ, polyester 160g
s vetracím otvorom; s kľúčkou
bez náklonu; bez klapiek

Snečník Victoria



kód	popis		
802059	Ø 300 cm / oceľ / bordová	1	13,000

Snečník Gabrielle



kód	popis		
802060	Ø 300 cm / oceľ / Mocca hnedá	1	22,000



STOJANY NA SLNEČNÍKY / STANDS

Stojan Nolan na slnečník



kód	popis		
802192	Ø 25x32 mm / nádoba 20 lit. / PE	1	

Stojan Dizzy na slnečník a závažie



kód	popis		
802191	A) Stojan DIZZY na slnečník 85x85x35 cm / Ø 48 mm / ocel	1	
802172	B) Závažie ASHER k stojanu DIZZY Ø 46x4 cm / ocel	1	17,000

Stojan Parker na slnečník



kód	popis		
802166	Ø 45x6,5 cm / ocel	1	14,000

Stojan Skyler na slnečník



kód	popis		
802171	Ø 39x4,5 cm / ocel	1	14,000

Stojan Carter na slnečník



kód	popis		
802170	Ø 45x6 cm / ocel-betón	1	20,000

Stojan Tyler na slnečník



kód	popis		
802167	Ø 50x7 cm / ocel	1	25,000

Stojan Dylan na slnečník



kód	popis		
802084	Ø 43x33 cm / živica	1	8,000

Stojan Greyson na slnečník



kód	popis		
802214	46x46x8 cm / 30kg	1	

Stojan Logan na slnečník



kód	popis		
802213	Ø35x8 cm / 16kg	1	

Stojan na slnečník



kód	popis		
802264	39x39x13 cm / antracit	1	
802262	39x39x13 cm / biely	1	
802263	39x39x13 cm / hnedý	1	

Stojan na slnečník



kód	popis		
802270	Ø39x13 cm / antracit	1	
802268	Ø39x13 cm / biely	1	
802269	Ø39x13 cm / hnedý	1	

Stojan Boris a Viktor

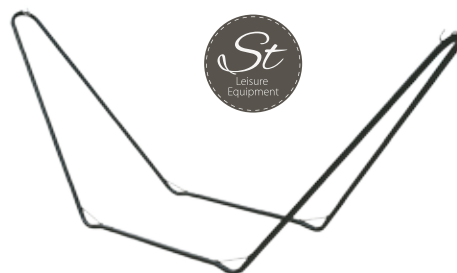

kód	popis		
802104	Viktor nos. 100 kg, 300x72x110 cm pre hojdaciu sieť Olga, Tamara, Galina a Irina		
802105	Boris nos. 150 kg, 345x109x120 cm pre hojdaciu sieť Olivia, Elena, Natasha		

Stojan Oleg



kód	popis		
802102	nos. 180 kg, 456x122x137 cm pre hojdaciu sieť Misha		

Stojan Taras



kód	popis		
802103	nos. 200 kg, 410x120x130 cm pre hojdaciu sieť Misha		

Stojan na kreslo Craig



kód	popis		
802106	nos. 200 kg, 238 cm pre hojdacie kreslo Craig		

Hojdacie siete 200x100 cm



A



B



C



D

kód	popis		
802112	A) IRINA, nos. 100 kg, bavlna		
802115	B) GALINA, nos. 100 kg, bavlna		
802116	C) OLGA, nos. 100 kg, bavlna		
802114	D) TAMARA, nos. 100 kg, bavlna		

Plážová podložka



kód	popis		
2210430	A) 700x1800 mm, Ocean	50	0,300
2210431	B) 900x1800 mm, Rainbow	50	0,300

Hojdacie siete



A



B



C



D

kód	popis		
802113	A) Olivia 200x150 cm, nos. 120 kg, bavlna		
802111	B) Elena 200x150 cm, nos. 130 kg, bavlna		
802107	C) Natasha 200x100 cm, nos. 150 kg, lano/PE		
802108	D) Misha 200x150 cm, nos. 200 kg, lano/PE		

Kreslo hojdicie Craig



kód	popis		
802162	zelené, 100x50 cm, nos. 150 kg		
802162	modré, 100x50 cm, nos. 150 kg		
802110	červené, 100x50 cm, nos. 150 kg		

Hojdacia sieť Ling

NOVINKA



kód	popis		
802236	Nos.: 200 kg, 240x160 cm, bavlna		

Kreslo hojdicie Trevor

NOVINKA



kód	popis		
802238	Nos.: 130 kg, 150x130 cm, bavlna Súčasťou balenia je pohodlný vankúš		

Kreslo hojdicie Garner

NOVINKA



kód	popis		
802237	Nos.: 130 kg, 150x130 cm, bavlna		

Kreslo hojdicie Craig



kód	popis		
802161	prírodné, 100x50 cm, nos. 150 kg		

HOJDAČKY A LAVIČKY

Záhradná hojdačka Alipascha LUX



250 kg

kód	popis		kg
802018	257x174x235 cm / oceľ / Mocca hnedá-čierna	1	49,000
802085	sieť náhradná	1	

Záhradná hojdačka Dubaj



250 kg

kód	popis		kg
802058	201x125x180 cm / oceľ / sivá	1	49,000
802071	plátno na striešku	1	
802083	pružina náhradná	2	

Záhradná hojdačka Lenox



250 kg

kód	popis		kg
802052	194x118x170 cm / oceľ / sivá	1	38,000
802073	plátno na striešku	1	
802081	pružina náhradná	2	

Záhradná hojdačka Hurghada, ratanová



240 kg

kód	popis		kg
802164	203x175x138 cm / oceľ / sivá	1	40,000
802255	plátno na striešku	1	
802257	pružina náhradná	2	
802256	rám na striešku	1	
802258	sedák náhradný	1	

pevná oceľová konštrukcia / čierny ratan / poduška vínovej farby / výška operadla: 65 cm

Záhradná hojdačka Cairo



150 kg

kód	popis		kg
802053	175x112x155 cm / oceľ / čierne-sivá	1	25,000
802070	plátno na striešku	1	
802076	rám na striešku	1	
802080	pružina náhradná	2	

Záhradná hojdačka Garfield



150 kg

kód	popis		kg
802054	173x112x158 cm / oceľ / zeleno-biela	1	21,50
802072	plátno na striešku	1	
802082	pružina náhradná	2	
802074	sedák náhradný	1	

HOJDAČKY A LAVIČKY

Záhradná hojdačka LQ Frederica

NOVINKA



300 kg

kód	popis	1
802246	235x115x180 cm / drevo / zelená	1

Kreslo hojdacie BUENG, ratan

NOVINKA



150 kg

kód	popis	1
802250	200 cm, Ø základne 1.05 m / latté	1
802253	náhradný sedák latté	1

Kreslo hojdacie Monaco



120 kg

kód	popis	1
802193	200x116x205 cm, krémové	1

Oceľové rúrky: 60x2.6mm/42x2.0mm/22mm/14mm; Textil: 180g/sqm polyester; Výplň sedáka: polyester fiber 4cm; Sedák: textil 2x1; 600D Oxford; PVC poťah lemovaný čiernym motúzom

Záhradná hojdačka Casablanca

NOVINKA



250 kg

kód	popis	1
802254	194x119x170 cm / kov	1
802260	plátno na striešku	1
802261	pružina náhradná	2
802259	rám na striešku	1

Kreslo hojdacie SARABURI, ratan

NOVINKA



150 kg

kód	popis	1
802251	200 cm, Ø základne 1.05 m / ivory	1
802275	náhradný sedák ivory	1

Kreslo hojdacie Monaco



120 kg

kód	popis	1
802212	200x116x205 cm, antracit	1

Oceľové rúrky: 60x2.6mm/42x2.0mm/22mm/14mm; Textil: 180g/sqm polyester; Výplň sedáka: polyester fiber 4cm; Sedák: textil 2x1; 600D Oxford; PVC poťah lemovaný čiernym motúzom

Altánok ARNOLD

NOVINKA



kód	popis	1
802216	3x3x2.6 m / plachta PE / konštrukcia kov / béžová	1

Kreslo hojdacie RAYONG, ratan

NOVINKA



150 kg

kód	popis	1
802249	200 cm / Ø základne 1.05 m / oker	1
802274	náhradný sedák oker	1
802252	náhradný sedák antracit	1

Plachta ROWENA



NOVINKA

kód	popis	1
802215	3.6x3.6 m / plachta PE / béžová	1

SWINGS AND BENCHES

Hojdačka drevená LEQ KATANA



kód	popis		
802232	detská, 40x16x1.2 cm, Ø lana 10 mm	1	

Hojdačka plastová LEQ ABELLA



kód	popis		
802173	modrá, 43x17x8.5 cm, lana Ø 10 mm	1	
802175	zelená, 43x17x8.5 cm, lana Ø 10 mm	1	
802174	žltá, 43x17x8.5 cm, lana Ø 10 mm	1	

Hojdačka plastová LEQ DEBBI



kód	popis		
802176	detská, 28x36x42 cm, lana Ø 10 mm	1	

Hojdačka drevená LEQ HANAKO



kód	popis		
802177	detská, 30x30 cm, lana Ø 10 mm	1	

Háky k hojdačkám



kód	popis		
802183	A) hák M12x140 mm	1	
802181	B) hák Ø 100x3 mm	1	
802182	C) hák M10x160 mm	1	

Hojdačka plastová LEQ ARACHNE



kód	popis		
802178	Ø 95 mm	1	

Hojdacie lano LEQ LUIX



kód	popis		
802179	2 m; plast Ø 26 mm	1	

Pieskovisko LEQ SANBOX + plachta



kód	popis		
802180	95x95x15 cm, drevo	1	

Záhradná trampolína + ochranná sieť



Výška: 76 cm (so sieťou: 240 cm) / Počet pružín: 48 / Maximálna váha osoby: 150kg / Ochrana tyčí siete - PENA! / Kvalitná polypropylénová skákacia plocha! / Konštrukcia z kalenej ocele odolná voči deformáciám / Dvojvrstvová ochrana pružín (PVC + PENA)! / Galvanizované, obojstranne pozinkované profily! / Súčasťou balenia: rebrík, zakrývacia plachta, sieť, 4 kotvy

kód	popis		
802165	A) Ø 251 cm / 3 dvojité nohy - zaručujúce dokonalú stabilitu / sieť vonkajšia		
802168	A) Ø 305 cm / 3 dvojité nohy - zaručujúce dokonalú stabilitu / sieť vonkajšia		
802169	A) Ø 366 cm / 4 dvojité nohy - zaručujúce dokonalú stabilitu / sieť vonkajšia		
802222	B) Ø 305 cm / 3 dvojité nohy - zaručujúce dokonalú stabilitu / sieť vnútorná + rebrík		802223
802200	vonkajšia sieť 2,4 m	802203	podložka, modrá PVC/PE
802201	vonkajšia sieť 3,0 m	802204	podložka, modrá PVC/PE
802202	vonkajšia sieť 3,6 m	802205	podložka, modrá PVC/PE
802209	náhradný rebrík 66x31 cm	802206	plachta zakrývacia, čierna
802210	náhradný rebrík 86x31 cm	802207	plachta zakrývacia, čierna
		802208	plachta zakrývacia, čierna

Rebrík na lezenie



kód	popis		
802233	detský, Ø lana 10 mm, L-2.1m	1	

Rukoväť plastová



kód	popis		
802235	bal. 2ks	2	

Kamene na lezenie, plastové



kód	popis		
802234	bal. 5 ks		

VOLNÝ ČAS

HOUSEHOLD



DOMÁCNOŠŤ



DOMÁCNOŠŤ

KACHLE, SPORÁKY, VLOŽKY A ZÁSTENY

Kachle AMBASADOR LM



kód	popis		
	dymovod Ø 118 mm účinnosť 69,6% výkon 10 kW rozmer 490x460x1040 mm		
2211000	béžové	1	82
2211001	červené	1	82

Kachle DIPLOMAT LUX



kód	popis		
	dymovod Ø 118 mm účinnosť 57,6% výkon 10 kW rozmer 480x450x1000 mm		
2211003	béžové	1	68
2211002	červené	1	68

Kachle EKONOMIK LUX



kód	popis		
2210996	dymovod Ø 118 mm účinnosť 63% výkon 7 kW rozmer 400x460x900 mm	1	48

Kachle BLIST B10



kód	popis		
2210997	dymovod Ø 118 mm účinnosť 66% výkon 9 kW rozmer 465x390x970 mm	1	57

Kachle BLIST B2



kód	popis		
2210999	dymovod Ø 118 mm účinnosť 66% výkon 9 kW rozmer 465x460x910 mm	1	62

Kachle Bella Thalia



kód	popis		
221255	855x485x440 mm, 5kW, zelené dymovod Ø 115 mm	1	72,000
221033	855x485x440 mm, 5kW, červené dymovod Ø 115 mm	1	72,000
2211018	Rošt	1	
2211017	Platňa horná	1	

Sporák PELA



- vylepšené ohnisko
- teplovzdorná farba
na zadnej stene sporáka
a stenách rúry

kód	popis		
	Dymovod: horný / bočný Výkon: 8,5 kW Priemer rúr: Ø 118 Rozmer (ŠxHxV): 830x574x760 mm Rozmer pece: 200x450x350 mm Rozmery rúry: 450x480x230 mm		
2210729B	horný vývod / biely / ľavý	1	90,000
2210730B	horný vývod / biely / pravý	1	90,000
2210731B	horný vývod / hnedý / ľavý	1	90,000
2210732B	horný vývod / hnedý / pravý	1	90,000
2210494B	bočný vývod / biely / ľavý	1	90,000
2210495B	bočný vývod / biely / pravý	1	90,000
2210496B	bočný vývod / hnedý / ľavý	1	90,000
2210497B	bočný vývod / hnedý / pravý	1	90,000
2211011	Kryt hnedý	1	
2211009	Kryt biely	1	
2211016	Platňa celá	1	
2211013	Platňa pravá, horná	1	
2211014	Platňa ľavá, horná	1	
2211015	Platňa s dierou	1	
2211012	Rošt	1	

Sporák Smederavec



kód	popis		
	Dymovod: pravý / ľavý Výkon: 6 kW Priemer rúr: Ø 120 Rozmer (ŠxHxV): 945x645x740 mm Rozmery pece: 195x200x400 mm Rozmery rúry: 200x490x460 mm Účinnosť: 60%		
2210734	biely / ľavý	1	84,000
2210733	biely / pravý	1	84,000
2210735	hnedý / ľavý	1	84,000
2210736	hnedý / pravý	1	84,000

Kachle FIPA 034



kód	popis		
221064	B) 550x480x665 mm, 10 kW dymovod Ø 170 mm materiál: liatina	1	135,000

Zástena ku krbu



kód	popis		
2210790	60x95 cm	1	2,430

Krbová vložka



kód	popis		
221555	700x460x800mm / 16 kW dymovod Ø 200 mm materiál: liatina max. dĺžka polena: 530 mm	1	139,000

Kachle FIPA 035



kód	popis		
221062	545x500x770 mm, 12 kW dymovod Ø 160 mm materiál: liatina	1	121,000

Zástena ku krbu



kód	popis		
2210789	60x95 cm	1	4,875

Krbová vložka



kód	popis		
221551	700x450x653mm / 13 kW dymovod Ø 150 mm materiál: liatina max. dĺžka polena: 530 mm	1	121,000

Kachle Thorma KERPEN II



NOVINKA

kód	popis		
2210138	Výkon: 5 kW Teplota spalin: Drevo. 320 °C, Hnedouhľové brikety 360 °C, Čierne uhlie 390 °C Vyhrevnosť: 48-124 m ³ Priemer dymovodu: 120 mm Dymovod: zadný Minimálny ťah: 12 Pa Pripustné paliva: Drevo, brikety z hnedého uhlia, čierne uhlie	1	121,000

Zástena ku krbu



kód	popis		
2210925	540x950 mm	1	3,083

KRBOVÉ NÁRADIE A SVIEČKY

Stojan na drevo FireWOOD



kód	popis		
2110245	39,3x126,2x118 cm	1	11,800

hrúbka konštrukcie: 38 mm; materiál plachty: PE

Stojan na drevo s náradím



kód	popis		
2110244	350x310x810 cm	1	7,300

náradie: lopatka, kutáč, smeták; Ø kolieska 152 mm; rukoväť: nerez; hrúbka konštrukcie: 22 mm

Taška na drevo



kód	popis		
221372	71x35 cm / max. 25kg / polyester	1	0,530

Stojan na pílenie dreva



kód	popis		
2170099	Pracovná výška: 60/64/68 cm Výška: 80 cm Max. zaťaženie: 150 kg Pre polená s priemerom 40 cm Skladací pre úsporu miesta Robustné a pozinkované kovové profily	2	8,500

Noša na drevo



kód	popis		
2210926	36x35x48 cm	1	3,700

Noša na drevo



kód	popis		
2210788	46x35,5x40,5 cm	1	3,880

Noša na drevo



kód	popis		
2210786	480 mm	1	1,660

Noša na drevo

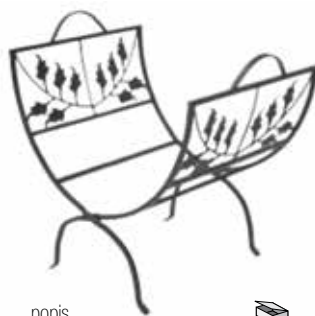

kód	popis		
2210787	52x35,5x45 cm	1	3,950

Lopatka na uhlie

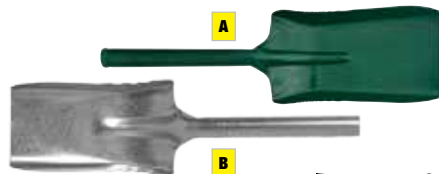

kód	popis		
221310	A) lakovaná	1	0,250
221281	B) Zn	50	0,256

Uhliak násypný



kód	popis		
2210927	A) 600 mm, plechový	1	1,416
211460	B) plechový, pozinkovaný	1	2,900

Uhliak hranatý



kód	popis		
211588	plechový, lakovaný	1	2,200

Uhliak s lopatkou



kód	popis		
2210818	plechový, lakovaný	1	

Kutáč roštový



kód	popis		
221375	drevenná rúčka	1	

Kutáč roštový



kód	popis		
2210820	500 mm / Fe+Zn / háčik	1	

Kutáč roštový



kód	popis		
2210819	500 mm / Fe+Zn	1	

Sada krbového náradia



kód	popis		
221909	A) 4 dielna, nerezová, 53 cm	1	3,166
221378	B) 4 dielna, čierna, 60 cm	1	3,360

Sada krbového náradia



kód	popis		
221377	A) 5 dielna, poniklovaná, 66 cm	1	4,150
221379	B) 5 dielna, čierna, 81 cm	1	5,150

Sada krbového náradia



kód	popis		
221376	4 dielna, nerezová, 66cm	1	3,050

Sviečka, Citronella



kód	popis		
2170303	A) čajovka / 6ks	120	0,078
2170294	B) čajovka / 12ks	60	0,160

Sviečka, Citronella



kód	popis		
2170295	A) 610g, vedierko / 15x15 cm	12	0,610
2170296	B) 510g, vedierko / 16x13 cm	12	0,510

Sviečka, Citronella



kód	popis		
2170305	A) vedierko / 8x7.2 cm	60	0,050
2170299	B) vedierko / 8x7.2 cm	60	0,080

Sviečka, Citronella



kód	popis		
2170302	vedro / 12x6 cm	48	0,130

Sviečka, Citronella



kód	popis		
2170300	pohár / 8x7 cm	60	0,080

Sviečka, Citronella



kód	popis		
2170306	A) terracotta / 12.5x3 cm	36	0,080
2170301	B) terracotta / 8x7 cm	60	0,060

Sada sviečok v stojane



kód	popis		
2170297	144 dielna	1	18,000
2170303	A) čajovka / 6ks	120	0,078
2170294	A) čajovka / 12ks	60	0,160
2170299	B) vedierko / 8x7.2 cm	60	0,080
2170300	C) pohár / 8x7 cm	60	0,080
2170301	D) terracotta / 8x7 cm	60	0,060
2170302	E) vedro / 12x6 cm	48	0,130
2170304	F) fakľa / 50x2.5 cm	96	0,048

Sviečka, Citronella



kód	popis		
2170304	fakľa / 50x2.5 cm	96	0,048

Fakľa bambusová



kód	popis		
2210776	A) 0350 mm, stolová	1	0,333
2210518	B) 0600 mm	1	0,180
2210519	B) 0900 mm	1	0,220
2210520	B) 1200 mm	1	0,320
2210872	B) 1500 mm	1	0,500
2170278	C) knôt 120 mm / bal. 10 ks	200	0,025
2170279	C) knôt 210 mm / bal. 10 ks	200	0,040

Strojček na prieduchy, PA



kód	popis		
217698	160 mm	1	
217697	160 mm, so závažím	1	

Komínová rúžica, pružinová



kód	popis		
217696	160 - 200 mm	1	
217695	160 - 200 mm, so závažím	1	

Komínová rúžica, pružinová



kód	popis		
217694	200 mm	1	
217687	200 mm, so závažím	1	

Komínová rúžica, pružinová



kód	popis		
217693	150 mm	1	
217686	150 mm, so závažím	1	

Kefa komínová, štosákový



kód	popis		
253437	150 mm, Inox	1	
253438	180 mm, Inox	1	
253439	200 mm, Inox	1	
253477	180 mm, Steel	1	

Kefa komínová, okrúhla, fibr.



kód	popis		
253532	120 mm / M12	1	
253533	140 mm / M12	1	
253534	160 mm / M12	1	
253535	180 mm / M12	1	
253536	200 mm / M12	1	

Kefa komínová, okrúhla, ocel



kód	popis		
253302	025 mm / okrúhla	20	0,060
253501	030 mm / okrúhla	20	0,070
253325	040 mm / okrúhla	20	0,080
253303	050 mm / okrúhla	20	0,090
253304	060 mm / okrúhla	20	0,100
253305	070 mm / okrúhla	20	0,105
253306	080 mm / okrúhla	20	0,108
253307	090 mm / okrúhla	20	0,120
253308	100 mm / okrúhla	20	0,140
253309	120 mm / okrúhla	20	0,160
253310	130 mm / okrúhla	20	0,165
253311	150 mm / okrúhla	20	0,200
253312	160 mm / okrúhla	20	0,250
253313	180 mm / okrúhla	20	0,260
253324	200 mm / okrúhla	20	0,300

Kefa komínová, hranatá, ocel



kód	popis		
253314	040x070 mm / hranatá	20	0,100
253315	040x080 mm / hranatá	20	0,110
253316	040x090 mm / hranatá	20	0,115
253344	040x100 mm / hranatá	20	0,120
253238	040x120 mm / hranatá	20	0,125
253317	050x080 mm / hranatá	20	0,100
253321	050x100 mm / hranatá	20	0,120
253246	060x100 mm / hranatá	20	0,140
253267	090x110 mm / hranatá	20	0,140

Kefa komínová, okrúhla, ocel



kód	popis		
253093	160 mm M12 + drôt	1	

Kefa komínová, okrúhla, silon



kód	popis		
253537	120 mm / M12	1	
253538	140 mm / M12	1	
253539	160 mm / M12	1	
253540	180 mm / M12	1	
253541	200 mm / M12	1	



Nádstavec komínový, M12



kód	popis		
217084	01 m / kov	1	
217085	02 m / kov	1	
217083	03 m / kov	1	
217086	04 m / kov	1	
217072	05 m / kov	1	
217434	06 m / kov	1	
217073	07 m / kov	1	
217400	08 m / kov	1	
217401	09 m / kov	1	
217404	10 m / kov	1	

Nádstavec komínový, M12



kód	popis		
2170192	01 m / sklolaminát	1	
2170193	02 m / sklolaminát	1	
2170194	03 m / sklolaminát	1	
2170195	04 m / sklolaminát	1	
2170196	05 m / sklolaminát	1	
2170197	06 m / sklolaminát	1	
2170198	07 m / sklolaminát	1	
2170199	08 m / sklolaminát	1	
2170200	09 m / sklolaminát	1	
2170201	10 m / sklolaminát	1	

Dvierka komínové ANKO

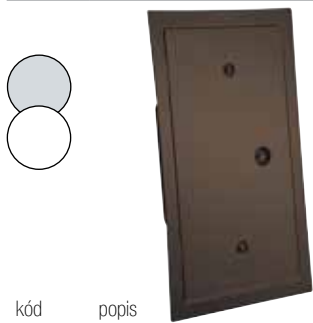

kód	popis		
2210563	130x260 mm, hnedé	1	1,140
2210557	130x260 mm, Zn	1	1,140
2210560	130x260 mm, biele	1	1,140

Dvierka komínové ANKO

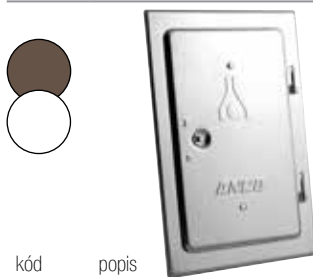

kód	popis		
2210562	160x280 mm, hnedé	1	1,400
2210556	160x280 mm, Zn	1	1,400
2210559	160x280 mm, biele	1	1,400

Dvierka komínové ANKO

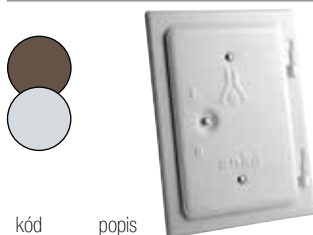

kód	popis		
2210561	120x180 mm, hnedé	1	0,680
2210555	120x180 mm, Zn	1	0,680
2210558	120x180 mm, biele	1	0,680

Dvierka komínové



kód	popis		
2210228	150x150 mm	1	
2210227	300x150 mm	1	

Platňa sporáková



kód	popis		
221595	425x250 mm	1	
221594	425x300 mm	1	
221605	425x320 mm	1	
221602	475x140 mm	1	
221649	480x140 mm	1	
221603	480x320 mm	1	
221596	500x285 mm	1	
221692	550x320 mm	1	
221625	630x155 mm	1	
221604	630x320 mm	1	
221165	630x315 mm, 1 otvor	1	
221694	630x315 mm, 2 otvory	1	

Rošt liatinový

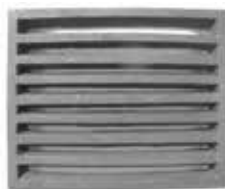

kód	popis		
221329	190, okrúhly	1	
221150	200, okrúhly	1	
221626	250, okrúhly	1	
221028	210x160x10 mm	1	
221614	210x160x15 mm	1	
221598	240x170x15 mm	1	
221600	250x170x12 mm, s uškami	1	
221599	255x210x15 mm	1	
221648	280x160x15 mm	1	
221622	280x230x15 mm	1	
221144	285x165x13 mm	1	
221690	315x210x15 mm	1	
221943	315x230x15 mm	1	
221944	330x230x15 mm	1	
221691	360x230x15 mm	1	
221762	360x260x15 mm	1	

Šnúra sporáková, pod platňu



kód	popis		
253440	1 m, 4x4 mm	1	
253441	1 m, 6x6 mm	1	
253442	1 m, 8x8 mm	1	
253443	1 m, 10x10 mm	1	
253444	1 m, 12x12 mm	1	
253445	2 m, 4x4 mm	1	
253446	2 m, 6x6 mm	1	
253447	2 m, 8x8 mm	1	
253448	2 m, 10x10 mm	1	
253449	2 m, 12x12 mm	1	

Plech pod kachle



kód	popis		
221701	0500x650 mm	1	1,400
221707	1000x650 mm	1	2,800

Plech pod kachle, lakovaný



kód	popis		
221949	0500x650 mm, lakované	1	1,600
221718	1000x650 mm, lakované	1	3,200

Plech pod kachle, farebný



kód	popis		
221706	400x475 mm, farebný	1	
221703	475x600 mm, farebný	1	

Tyč komínová, M14, plast



kód	popis		
217968	1 m / plast	1	

Rúra hrubostenná, ocelová



kód	popis		
221803	250x120x1,5 mm	1	
221689	250x120x1,5 mm + klapka	1	
221804	250x130x1,5 mm	1	
221805	250x150x1,5 mm	1	
221704	250x150x1,5 mm + klapka	1	
221806	250x150x2,0 mm	1	
221807	250x160x2,0 mm	1	
221867	250x180x1,5 mm	1	
221808	250x180x2,0 mm	1	
221679	250x200x1,5 mm	1	
221810	250x200x2,0 mm	1	
221795	500x120x1,5 mm	1	
221796	500x130x1,5 mm	1	
221797	500x150x1,5 mm	1	
221798	500x150x2,0 mm	1	
221799	500x160x2,0 mm	1	
221637	500x180x1,5 mm	1	
221801	500x180x2,0 mm	1	
221802	500x200x2,0 mm	1	
221745	1000x120x1,5 mm	1	
221746	1000x130x1,5 mm	1	
221790	1000x150x1,5 mm	1	
221791	1000x150x2,0 mm	1	
221792	1000x160x2,0 mm	1	
221793	1000x180x2,0 mm	1	
221794	1000x200x2,0 mm	1	

Redukcia hrubostenná, ocelová



kód	popis		
222000	Ø145x150x2,0 mm	1	
221859	Ø150x120x1,5 mm	1	
221857	Ø150x130x1,5 mm	1	
221716	Ø150x145x1,5 mm	1	
221856	Ø150x146x2,0 mm	1	
221486	Ø160x120x1,5 mm	1	
221487	Ø160x130x1,5 mm	1	
221231	Ø160x150x1,5 mm	1	
221855	Ø165x150x2,0 mm	1	
221488	Ø180x150x1,5 mm	1	
221721	Ø180x160x1,5 mm	1	
221854	Ø180x160x2,0 mm	1	
221489	Ø200x120x1,5 mm	1	
221494	Ø200x130x1,5 mm	1	
221719	Ø200x160x1,5 mm	1	
221853	Ø200x160x2,0 mm	1	
221720	Ø200x180x1,5 mm	1	
221852	Ø200x180x2,0 mm	1	
221511	Ø250x150x1,5 mm	1	

Koleno hrubostenné, ocelové 45°



kód	popis		
221811	45° / Ø120x1,5 mm	1	
221812	45° / Ø130x1,5 mm	1	
221813	45° / Ø150x1,5 mm	1	
221814	45° / Ø150x2,0 mm	1	
221816	45° / Ø160x2,0 mm	1	
221817	45° / Ø180x2,0 mm	1	
221818	45° / Ø200x2,0 mm	1	

Koleno hrubostenné, ocelové 90°



kód	popis		
221819	90° / Ø120x1,5 mm	1	
221820	90° / Ø130x1,5 mm	1	
221821	90° / Ø150x1,5 mm	1	
221822	90° / Ø150x2,0 mm	1	
221823	90° / Ø160x2,0 mm	1	
221824	90° / Ø180x2,0 mm	1	
221825	90° / Ø200x2,0 mm	1	

Koleno hrubostenné s čistiacim otvorom, ocelové 90°



kód	popis		
221826	90° / Ø120x1,5 mm	1	
221827	90° / Ø130x1,5 mm	1	
221828	90° / Ø150x1,5 mm	1	
221829	90° / Ø150x2,0 mm	1	
221830	90° / Ø160x2,0 mm	1	
221832	90° / Ø180x1,5 mm	1	
221831	90° / Ø180x2,0 mm	1	
221835	90° / Ø200x2,0 mm	1	

Koleno hrubostenné s čistiacim otvorom a klapkov, ocelové 90°



kód	popis		
221840	90° / Ø120x1,5 mm	1	
221842	90° / Ø130x1,5 mm	1	
221845	90° / Ø150x1,5 mm	1	
221846	90° / Ø150x2,0 mm	1	
221849	90° / Ø160x2,0 mm	1	
221850	90° / Ø180x2,0 mm	1	
221851	90° / Ø200x2,0 mm	1	

Zdiera hrubostenná, ocelová



kód	popis		
221872	Ø120x1,5 mm	1	
221874	Ø130x1,5 mm	1	
221876	Ø150x1,5 mm	1	
221877	Ø160x1,5 mm	1	
221892	Ø180x1,5 mm	1	
221898	Ø200x1,5 mm	1	
221811	Ø120x1,5 mm	1	

Viečko hrubostenné, ocelové



kód	popis		
221226	Ø120x1,5 mm	1	
221227	Ø130x1,5 mm	1	
221240	Ø150x1,5 mm	1	
221241	Ø160x1,5 mm	1	
221242	Ø180x1,5 mm	1	
221243	Ø200x1,5 mm	1	

Ružica hrubostenná, ocelová



kód	popis		
221880	Ø120x0,8 mm	1	
221904	Ø130x0,8 mm	1	
221906	Ø150x0,8 mm	1	
221213	Ø160x0,8 mm	1	
221217	Ø180x0,8 mm	1	
221220	Ø200x0,8 mm	1	

Prechodka hrubostenná, ocelová



kód	popis		
221592	Ø150x120x1,5 mm	1	
221537	Ø150x130x1,5 mm	1	
221538	Ø150x145x1,5 mm	1	
221871	Ø160x120x1,5 mm	1	
221870	Ø160x130x1,5 mm	1	
221869	Ø180x120x1,5 mm	1	
221866	Ø180x130x1,5 mm	1	
221865	Ø180x150x1,5 mm	1	
221540	Ø180x160x1,5 mm	1	
221864	Ø200x120x1,5 mm	1	
221863	Ø200x130x1,5 mm	1	
221862	Ø200x150x1,5 mm	1	
221861	Ø200x160x1,5 mm	1	
221539	Ø200x180x1,5 mm	1	

Klapka hrubostenná s krátkym tiahlom, oceľová



kód	popis		
221257	Ø120x1,5 mm	1	
221258	Ø130x1,5 mm	1	
221259	Ø150x1,5 mm	1	

Klapka hrubostenná s predĺženým tiahlom, oceľová



kód	popis		
221306	Ø150x2,0 mm	1	
221380	Ø160x2,0 mm	1	
221381	Ø180x2,0 mm	1	
221382	Ø200x2,0 mm	1	

Výmenník



kód	popis		
2211008	220x320x1000 mm ušetrí až 30% energie	1	1,800

Výmenník GAJO



kód	popis		
221998	118 mm	1	1,800
221999	132 mm	1	1,800
221989	152 mm	1	2,000

Rúra dymová, oceľová



kód	popis		
221643	100 mm	1	
221711	105 mm	1	
221712	112 mm	1	
221633	118 mm	1	
222992	120 mm	1	
221665	125 mm	1	
221630	132 mm	1	
221713	145 mm	1	
221714	152 mm	1	
221715	160 mm	1	

Rúra smaltovaná, Ø120mm



kód	popis		
221657	500 mm, biela	1	
221610	500 mm, hnedá	1	
221650	1000 mm, biela	1	
221609	1000 mm, hnedá	1	

Koleno dymové, oceľové



kód	popis		
221638	100 mm	20	0,420
221708	105 mm	20	0,470
221709	112 mm	20	0,530
221634	118 mm	1	
221239	120 mm	1	
221710	125 mm	16	0,630
221629	132 mm	1	
221736	145 mm	12	0,950
221737	152 mm	12	1,100
221739	160 mm	12	1,220

Zdiera dymová



kód	popis		
2210312	100 mm	1	0,115
2210303	105 mm	1	
2210304	112 mm	1	0,127
2210306	118 mm	1	
2210307	120 mm	1	
2210305	125 mm	1	0,143
2210313	132 mm	1	0,152
2210398	145 mm	1	0,165
2210399	152 mm	1	0,170
2210397	160 mm	1	0,180

Koleno dymové, smaltované



kód	popis		
221658	120 mm, biela	1	
221681	120 mm, hnedá	1	

Ružica dymová, medená



kód	popis		
2210314	100 mm	1	
2210315	105 mm	1	
2210317	112 mm	1	0,025
2210318	118 mm	1	0,030
2210320	120 mm	1	0,030
2210319	125 mm	1	0,030
2210316	132 mm	1	0,035
2210330	145 mm	1	
2210400	152 mm	1	0,040
2210396	160 mm	1	0,040

Zátka dymová, medená



kód	popis		
2210321	105 mm	1	0,055
2210322	112 mm	1	0,070
2210323	118 mm	1	0,070
2210324	120 mm	1	0,080
2210325	125 mm	1	0,125
2210326	132 mm	1	0,095
2210327	145 mm	1	0,100
2210328	152 mm	1	0,105
2210329	160 mm	1	0,105

PARÁKY, KOTLIKY A NÁDOBY

Hrniec Zn



kód	popis		
254017	15 lit	1	1,700
254018	20 lit	1	2,000
254019	30 lit	1	2,600
254020	40 lit	1	3,200

Parák Zn



kód	popis		
254023	15 lit	1	2,500
254024	20 lit	1	3,000
254025	30 lit	1	3,600

Parák Extra Zn



kód	popis		
254021	20 lit	1	3,100
254022	30 lit	1	3,800
254133	pokrievka na 20/30 lit	1	0,500

Vandlík Zn



kód	popis		
254086	16 lit	1	1,800

Vedro Zn



kód	popis		
254051	4 lit	1	0,750
254052	7 lit	1	1,140
254054	8 lit	1	1,290
254056	10 lit	1	1,320
254058	12 lit	1	1,500

Vedro Hobby, Zn



kód	popis		
254080	5 lit	1	0,600
254081	7 lit	1	0,740
254082	10 lit	1	0,740
254083	12 lit	1	0,940
254085	15 lit	1	1,040

Konva Zn



kód	popis		
254092	Ružica, Zn	1	0,170
254028	1.5 lit	1	0,600
254030	5 lit, s ružicou	1	1,500
254033	9 lit, s ružicou	1	2,000

Naberačka Zn



kód	popis		
221049	07 lit.	1	1,300

Parák PS-65



kód	popis		
254027	65 lit. / smaltovaný, komplet	1	35,000
254228	obal kotla	1	5,000
254269	rošt kotla, liatinový	1	1,000
254265	tesnenie kotla	1	0,200
254268	vložka kotla, smaltovaná	1	12,000

Parák P-65



kód	popis		
254026	65 lit. / pozinkovaný, komplet	1	20,000
254332	vložka kotla, Zn	1	5,000

Kotol smaltovaný



kód	popis		
254119	60 lit. / čierny / Výška: 43 cm / Ø 57 cm	1	7,500

BUCKETS WATERING AND GOULASH POT

Kotlina bez kotlíka



kód	popis		kotlík
254160	Ø 310 mm, dymovod Ø 120, koleno	1	6,8 lit.
254508	Ø 360 mm, dymovod Ø 120, koleno	1	10 lit.
254509	Ø 390 mm, dymovod Ø 120, koleno	1	13 lit.
254510	Ø 450 mm, dymovod Ø 120, koleno	1	20,25 lit.
254511	Ø 550 mm, dymovod Ø 120, koleno	1	60 lit.

Zabíjačková kotlová súprava



kód	popis		
254164	15 L • 610x360x360mm, 15 kg dymovod Ø 120	1	15,000

Zabíjačková kotlová súprava



kód	popis		
254122	60 L / dymovod Ø 120 • rozmer(vxšxh): 200x530x530mm	1	26,000

Smaltovaný kotlík, piknik



kód	popis		
254257	0,8 lit.	1	
254256	06 lit.	1	0,960
254232	08 lit.	1	1,100
254233	10 lit.	1	1,350
254235	13 lit.	1	1,380
254234	16 lit.	1	1,680
254236	20 lit.	1	2,400
254239	25 lit.	1	2,450
254237	stojan / 1200 mm, s retiazkou	1	

Antikorová pokrievka, nerezová



kód	popis		
254476	06 lit.	1	0,270
254477	08 lit.	1	0,240
254478	10 lit.	1	0,290
254479	13 lit.	1	0,360
254480	22 lit.	1	0,265

Antikorový kotlík, nerezový



kód	popis		
254259	0,8 lit.	1	0,220
254471	06 lit.	1	0,650
254472	08 lit.	1	0,880
254473	10 lit.	1	1,040
254474	13 lit.	1	1,280
254475	22 lit.	1	1,000

Liatinový kotlík



kód	popis		
254481	7,20 lit.	1	4,800
254482	10,80 lit.	1	6,200
254483	16,00 lit.	1	9,500

Stojan piknik na kotlík



kód	popis		
254237	1200 mm, s retiazkou a hákom	1	3,100

Kanister plastový



kód	popis		
254312	10 lit / s ventilom	6	0,450
254313	20 lit / s ventilom	6	0,790
254149	15 lit / bez ventilu	6	0,700
254150	20 lit / bez ventilu	6	0,770
254186	25 lit / bez ventilu	6	0,945
254151	30 lit / bez ventilu	6	1,170

Kanister plastový



kód	popis		
254240	05 lit. / stohovateľný	1	0,410
254178	10 lit. / stohovateľný	1	0,385

Kanister, PVC • na PHM



kód	popis		
254168	05 lit	1	0,405
254145	10 lit	1	0,687
254146	20 lit	1	1,092

Kanister na PHM



kód	popis		
254387	A) 05 lit		
254385	A) 10 lit		
254382	A) 20 lit		
254689	B) 05 lit	162	0,405
254108	B) 10 lit	95	0,687
254109	B) 20 lit	48	1,092

Kanister plastový, kombinovaný



kód	popis		
254491	6+2,5 lit.	1	

Kanister



kód	popis		
254042	5 lit.	12	1,500
254136	10 lit.	8	2,500
254137	20 lit.	4	4,000
217898	tesnenie na hrdlo kanistra	100	0,005

Nástavec na kanister



kód	popis		
217135	A) so sítkom, kov	1	0,360
217792	B) so sítkom, 280 mm, kov/plast	1	0,300
217032	C) bez sítku, kov/plast	1	0,300

Nástavec na kanister



kód	popis		
217752	355 mm, plast	1	

Olejníčka



kód	popis		
222947	300 ml, kovová	10	0,033
222964	500 ml, kovová	10	0,033

Lievik plastový



kód	popis		
217482	120 mm	1	0,026
217483	140 mm	1	0,031
217484	160 mm	1	0,042
217485	180 mm	1	0,067
217486	210 mm	1	0,109
217487	250 mm	1	0,200
217895	320 mm	1	0,351
217422	380 mm	1	0,639
217423	450 mm	1	0,716

Lievik plastový s filtrom

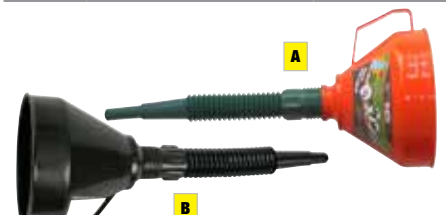

kód	popis		
222835	A) Ø 160 mm	72	0,120
221352	B) Ø 140 mm	72	0,120
221427	B) Ø 160 mm	72	0,120

Lievik plastový



kód	popis		
221779	sada 3ks - 80, 120 a 160 mm	1	0,110

Pumpa prečerpávacia, ručná



kód	popis		
235119	32x125 cm	1	

Pumpa na odsávanie benzínu a oleja



kód	popis		
235127	Vákuová pumpa, univerzálna prípojka, 2lit. nádoba, 120 cm hadica pre benzín a olej	1	

CANISTERS AND BUCKETS

Vandlík



kód	popis		
254355	23 lit., 47 cm	1	1,100
254357	38 lit., 57 cm	1	1,600
254341	40 lit.	1	2,000
254342	45 lit.	1	2,400
254343	70 lit.	1	3,000

Vandlík



kód	popis		
254356	30 lit., 52 cm, biely	1	1,500
254401	30 lit., 52 cm, modrý	1	1,500

Vandlík 10 lit.



kód	popis		
254363	biely / 10lit.	1	0,260
254364	modrý / 10lit.	1	0,266
254365	oranžový / 10lit.	1	0,280
254360	biely / 15lit.	1	0,380
254361	modrý / 15lit.	1	0,380

Vandlík hranatý



kód	popis		
254435	10 lit. / modrý	1	0,266
254367	15 lit. / biely	1	0,430
254368	15 lit. / modrý	1	0,400
254366	15 lit. / oranžový	1	0,400

Vedro s výlevkou



kód	popis		
254545	10 lit. / 29x31x27 cm, biele	1	0,374
254546	10 lit. / 29x31x27 cm, modré	1	0,374
254547	10 lit. / 29x31x27 cm, fuxia	1	0,374

Vedro s výlevkou



kód	popis		
254468	10 lit., modré	1	0,338

Vedro



kód	popis		
254288	A) 10 lit, s vrchnákom	1	0,530
254326	A) 15 lit, s vrchnákom	1	0,740
254329	B) 20 lit	1	1,231

Vedro s výlevkou



kód	popis		
2212001	10 lit., 295 mm	1	1,231

Nádoba na mäso a ryby



kód	popis		
254417	500x340x120 mm	1	0,640

Vedro



kód	popis		
254397	s výlevkou / 9 lit.	1	0,333
254399	bez výlevky / 9 lit.	1	0,359

Vedro plastové



kód	popis		
254314	06 lit	1	0,340
254315	09 lit	1	0,467
254316	12 lit	1	0,711
254317	15 lit	1	0,809
254279	09 lit, s výlevkou	1	0,567
254281	12 lit, s výlevkou	1	0,912
254283	14 lit, s výlevkou	1	0,799

Vedro



kód	popis		
254351	06 lit.	1	0,340
254352	09 lit.	1	0,467
254353	12 lit.	1	0,711
254354	15 lit.	1	0,809
254280	09 lit., s výlevkou	1	0,567
254282	12 lit., s výlevkou	1	0,912
254284	14 lit., s výlevkou	1	0,799

Mop s palicou



kód	popis		
253494	A) chenille/98x40x25 cm	30	0,566
253508	A) chenille/ náhrada	1	0,130
253495	B) microfiber/96x34.5x29 cm	25	0,512
253505	B) microfiber/ náhrada	1	0,064

Mop s palicou



kód	popis		
253497	A) microfiber/98x14.5x34.5 cm	10	0,590
253506	A) microfiber/ náhrada	1	0,096
253496	B) microfiber/98x42x31 cm	30	0,483
253507	B) microfiber/ náhrada	1	0,080

Prachovka a stierka



kód	popis		
2210522	A) Flexi/128x17.5x14 cm	1	
221315	B) 2 in 1/105x33x33 cm	1	0,300

Stierka so škrabkou



kód	popis		
2210505	200 mm, teleskopická	1	0,367

Čistiaca súprava - stierka, leštička



kód	popis		
2210507	2x230 mm	12	0,792

Mop s rozprašovačom



kód	popis		
253581	A) 300x095 mm, 1250 mm	12	0,983
253598	B) náhradná špongia 330x130 mm	12	1,102

Prachovky



kód	popis		
2210510	A) teleskopická/	48	0,314
2210512	B) teleskopická	48	0,343

Stierka na okná



kód	popis		
2212080	250 mm, silikonová	1	0,090

MOPS, SPATULAS AND DUSTERS

Súprava upratovacia

NECO
NECO CLEANING



kód	popis		
253490	metla + lopata	6	1,100

Stierka na okná s nádobkou 3v1



NOVINKA

NECO
NECO CLEANING

kód	popis		
2212059	250 mm, striekacia nádobka	1	

Stierka na okná



NECO
NECO CLEANING

kód	popis		
2210506	200 mm, teleskopická	48	0,227

Utierka rukavicová



NECO
NECO CLEANING

kód	popis		
313664	240x200 mm	48	0,092

Lopatka s metličkou

NECO
NECO CLEANING



kód	popis		
253568	plast / 2 v 1	1	0,248

Mop na podlahu

kód	popis		
253407		12	0,708
253516	náhradná špongia	1	0,120

Mop na podlahu + špongia zdarma

kód	popis		
253339	DuoRoller - 2 valčeky	20	0,760
253338	MonoRoller - 1 valček	20	0,653
253285	náhradná špongia	50	0,123

Mop na podlahu

kód	popis		
253562	1200 mm / teleskopický	1	0,388

Mop na podlahu

kód	popis		
253283	DustMagic	12	0,500
253561	Microfiber, násada 1200 mm	1	

Mop na podlahu

kód	popis		
253380	Microfiber	6	0,500
253594	náhradná hlava	6	0,150

Mop na podlahu

kód	popis		
253567	Microfiber	24	0,500

Lopatka s metličkou

NECO
NECO CLEANING



NOVINKA

kód	popis		
253714	plast / 2 v 1	1	0,193

Lopatka

NECO
NECO CLEANING



kód	popis		
2210508	červená, bez gumovej lišty	12	0,392
2210509	červená, gumová lišta	12	0,400

Súprava upratovacia

NECO
NECO CLEANING



NOVINKA

kód	popis		
253713	metla + lopatka	1	0,193

Metla so stierkou

NECO
NECO CLEANING



kód	popis		
253569	300 mm	12	0,758

DOMÁCNOSŤ

Mop náhradný



kód	popis		
253560	A) microfibre	1	0,156
253522	A) syntetic, SuperHit	1	0,100
253520	B) microfibre, farebný	1	0,100

Mop náhradný



kód	popis		
253521	bavlnený, SuperLux	1	0,100
253519	microfibre, 100% polyester	1	0,100
253559	microfibre, bavlna	1	0,100

Upratovacia súprava EKONEX



kód	popis		
253432	mop	1	14,700

Handra Intelligent



kód	popis		
253489	400 mm, náhrada	48	0,117

Stierač na okná



kód	popis		
216810	300 mm	25	0,280

Súprava WetMOP



kód	popis		
253410	násada: 105 cm mop bavlnený, nádoba 12 lit	1	0,400

Mop Klasik



kód	popis		
253412	Micro, teleskopická tyč 64 - 113 cm	1	1,000

Stierka na okná



kód	popis		
221314	200 mm/38.5x23x28.5 cm	24	0,270

Stierka na okná



kód	popis		
221563	200 mm	1	0,073
221564	250 mm	1	0,094
221565	300 mm	1	0,104

Amazing Mop



kód	popis		
253413	teleskopická tyč 120 cm	1	2,900
253414	plastová nádoba 7 lit.	1	0,186
2210827	náhradný mop spojka na palicu	1	

Súprava upratovacia



NECO
NECO CLEANING



kód	popis		
253715	teleskopická tyč: 94-120 cm súprava obsahuje vedro, mop a 360° rotačnú hlavicu z kvalitného a odolného materiálu.	1	2,850

Vedro na mop



kód	popis		
254493	14 lit.	1	0,608

Kefa na umývanie aut

AQUACRAFT



kód	popis		
256646	nastavovací ventil	6	

Kefa na umývanie auta



kód	popis		
253095		1	0,230

Palica so závitom



kód	popis		
2212082	1100 mm	1	

Palica so závitom



kód	popis		
2212083	1100 mm, standard	1	

Palica so závitom



kód	popis		
2212084	1300 mm, standard	1	

Palica so závitom



kód	popis		
2212085	1250 mm, strong, kovová	1	

Palica so závitom



kód	popis		
2210481	Ekonex, 1200 mm	1	

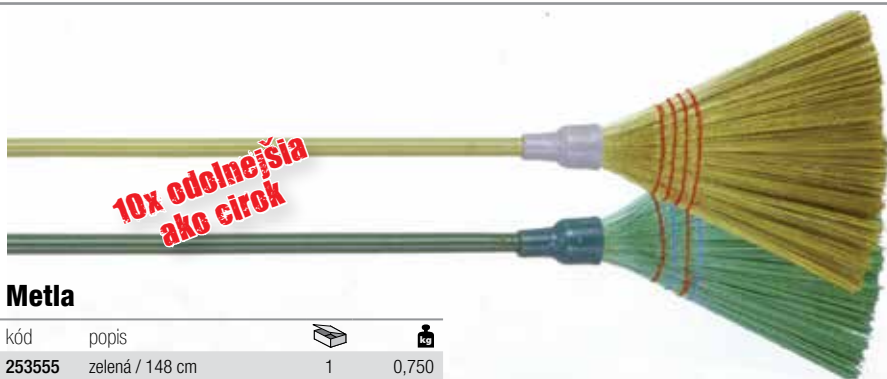

Metla

kód	popis		
253555	zelená / 148 cm	1	0,750
253557	žltá / 148 cm	1	0,750



Metla šikmá

kód	popis		
253556	zelená / 153 cm	1	0,833
253558	žltá / 153 cm	1	0,833



Metla

kód	popis		
253554	zelená / 165 cm	1	0,760



Metla pre domácnosť

kód	popis		
2210335	teleskopická 42-82 cm	24	0,708

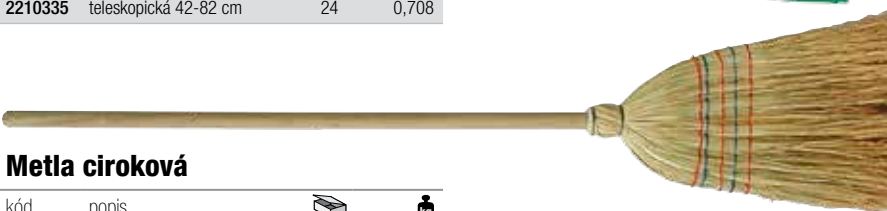

Metla ciroková

kód	popis		
221111	5x šitá / 89 cm	1	1,000



Metla ciroková

kód	popis		
221101	detská / 65 cm	1	0,200

Metla ciroková



kód	popis		
221052	malá / 12.5 cm	1	0,300

Mechanická metla Sandy

Nerezová teleskopická rúčka
Pohodlné nastavenie na vhodnú dĺžku.

Otočná kefa
Nylonové štetiny ľahko zmetú prach, vrátane vlasov, do zbernej nádoby.

Okrúhle kefy
Zlepšujú efektivitu a jednoducho vyčistia rohy.

Zberná nádoba na nečistoty
Veľká úložná kapacita



Otáčanie o 360°, vďaka čomu sa dostanete do každého rohu, dokonca aj pod pohovkou či pod konferenčný stôl.

Stierka
Odstraňuje nečistoty zachytené na otočnej kefe.

Kryt zbernej nádoby
So zabudovanými magnetmi, ktoré zabraňujú úniku nečistôt.

NOVINKA



kód popis

221759	chróm / červená	1
221125	chróm / ružová	1
221760	chróm / zlatá	1

Rozmer: 113x30x20 cm / Nádoba na nečistoty: 0,5 lit / Teleskopická rukoväť: max. 100 cm / Otočná rukoväť 360°



Metla

kód	popis		
253582	s násadou / 1200 mm	24	0,425



Metla

kód	popis		
253467	s násadou / 1200 mm	48	0,406

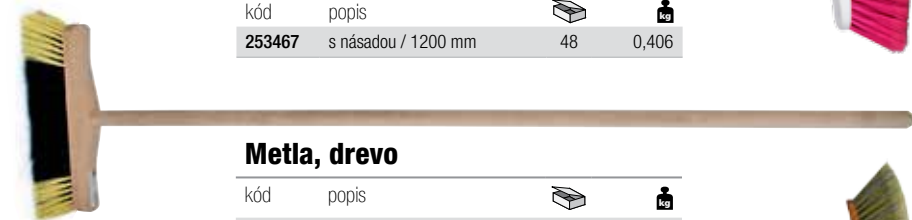

Metla, drevo

kód	popis		
253345	s násadou 1200 mm na závit	12	0,900



Metla na palicu, plast

kód	popis		
253346	s násadou 1200 mm na závit	1	0,900



Metla SORGO

kód	popis		
2210426	130 cm	1	0,800

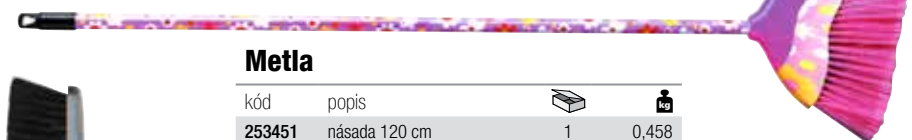

Metla

kód	popis		
253451	násada 120 cm	1	0,458

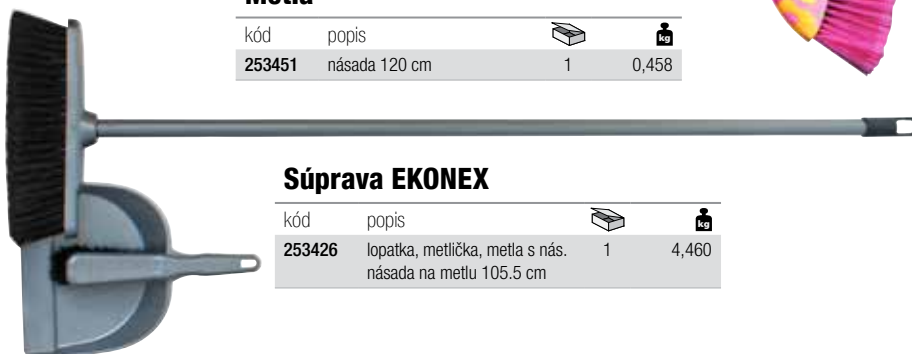

Súprava EKONEX

kód	popis		
253426	lopatka, metlička, metla s nás. násada na metlu 105.5 cm	1	4,460

Metla Popular



kód	popis		
253433	bez násady 305 mm	1	

Metla s násadou



kód	popis		
253452	násada drevená 110 cm	1	0,277

Metla



kód	popis		
253453	bez násady 285 mm	1	0,429
253450	s násadou 120 cm / 285 mm	1	0,500

Metla s násadou



kód	popis		
253293	násada 120 cm		

Metla s násadou



kód	popis		
253204	násada 120 cm		

Metla s násadou



kód	popis		
253483	300 mm / 120 cm	1	

Metla priemyselná



kód	popis		
253301	čierna	1	0,500
253300	hnedá	1	0,500
253287	120 mm / čierna s násadou	1	0,900
253288	120 mm / hnedá s násadou	1	0,900

Metla priemyselná



kód	popis		
253255	300 mm	10	0,440
253256	400 mm	10	0,560
253257	500 mm	10	0,670
253258	600 mm	10	0,780
253259	800 mm	10	1,050
253050	300 mm s násadou	10	
253118	400 mm s násadou	10	
253060	500 mm s násadou	10	
253232	600 mm s násadou	10	
253228	800 mm s násadou	10	

Metla Geco

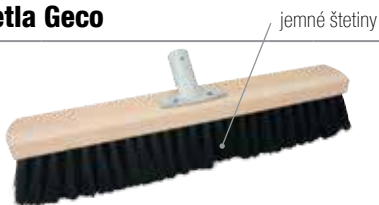

kód	popis		
253210	400 mm	1	0,300
253231	600 mm	1	0,400
253212	800 mm	1	0,500
253234	400 mm s násadou	1	
253240	600 mm s násadou	1	
253384	800 mm s násadou	1	

Metla cestárska PVC štetiny + ocelové štetiny



kód	popis		
253253	400 mm	1	
253579	400 mm s násadou	1	

Metla cestárska



kód	popis		
2530260	bez násady 300x65x22 mm	5	0,440

Metla záhradná s násadou



kód	popis		
253454	450mm, násada 135 cm	1	0,167
253480	600mm, násada 135 cm	1	1,583

Lopatka s metličkou



kód	popis		
253423	PP, SweepSet	1	0,500

Lopatka na smetie



kód	popis		
221309	PP, gumová lišta	1	0,100

Lopatka na smetie



kód	popis		
221280	PVC	1	0,089

Metlička ručná, drevo



kód	popis		
253291	drevená 290x40x18 mm	48	0,166

Lopatka na smetie



kód	popis		
221208		12	0,640

Lopatka na smetie



kód	popis		
221530	lakovaná, kovová s drevenou rúčkou	25	0,460

Lopatka na smetie



kód	popis		
221311	lakovaná, kovová	12	0,292

Metlička



kód	popis		
253425	PP, 290 mm	1	

Metlička



kód	popis		
221130	PP, 300 mm	1	0,101

Utierky z mikrovlákná



kód	popis		
253566	bal. 5ks / na všetky povrchy	1	0,166

Utierky z mikrovlákná



kód	popis		
253563	A) bal. 4ks / na všetky povrchy	1	0,196
253499	B) bal. 4ks / na všetky povrchy	24	0,208

Utierka



kód	popis		
253565	Microfiber	1	0,049

Utierka



kód	popis		
253564	Microfiber	1	0,040

Utierka



kód	popis		
312500	Universal / bavlna / 60x50 cm	1	0,146

Utierka



kód	popis		
312501	Classic / bavlna	1	0,043

Utierka



kód	popis		
312502	netkaná textília	10	0,100

Špongia



kód	popis		
2160394	A) 2 ks	40	0,075
2160330	B) na čistenie dlažby / 200x130x70 mm	1	0,050

Hubka NECO



kód	popis		
2210513	90x60x40 mm, 3ks	48	0,063

Hubka na riad



kód	popis		
312307	10 ks	1	0,050

Zvon, plast



kód	popis		
221569	malý	68	0,132

Zvon, guma



kód	popis		
313138	100 mm	24	0,166

Pumpa na čistenie odpadu



kód	popis		
2210585	4 v 1	1	1,080

Čistenie bez chemických prostriedkov s použitím tlaku až 4 bary.

Čistič odpadu



kód	popis		
2210586	6mm x 4m / čistiaca špirála	1	0,840

Špirála na čistenie odpadu



kód	popis		
221178	03 m / 6,3 mm	1	
221179	05 m / 10 mm	1	
221181	10 m / 10 mm	1	
221395	15 m / 10 mm	1	
221764	20 m / 11,2 mm	1	

Špirála na čistenie odpadu



kód	popis		
221036	05 m / 9 mm	10	1,300
221066	10 m / 9 mm	5	2,600
221730	15 m / 9 mm	5	4,000

Drôtenka na riad



kód	popis		
221567	2ks	1	0,051

Kefa KONEX na riad



kód	popis		
253429	hranatá	1	0,700

Sada kefa na riad



kód	popis		
253461	bal. 2 ks	1	0,104

Kefa na riad



kód	popis		
253470	260x70x50 mm	36	0,055

Kefa na fľaše



kód	popis		
253459	úzka, 50 mm	1	0,049

Kefa na fľaše



kód	popis		
253460	so špongiou, 60 mm	1	0,072

Kefa na fľaše



kód	popis		
253458	na fľaše, 50 mm	1	0,062

Kefka na riad



kód	popis		
221136	300 mm, plast	1	

Kefa



kód	popis		
253462	A) plast	1	0,092
253463	B) plast	1	0,104

Kartáč podlahový



kód	popis		
253141	180 mm	12	0,167

Kefa na obuv



kód	popis		
253142	140 mm	12	0,750

Ryžák na palicu



kód	popis		
253181	220x65 mm	12	0,170

WC súprava



kód	popis		
221055	nerezová	1	

Súprava WC



kód	popis		
253457	12,5x38,5 cm	24	0,175

WC súprava EKONEX



kód	popis		
253428		1	

Súprava WC



kód	popis		
253529	wc	1	0,256

Kefa WC



kód	popis		
253456		1	0,090

Kefa WC



kód	popis		
253455	8x39 cm	1	0,114

Kefa WC



kód	popis		
253427		1	0,110

Kefa WC



kód	popis		
253479		1	0,117

Držiak na toaletný papier



kód	popis		
2212073	nerez	16	0,513

Žehliace dosky

eurogold®



kód	popis		
2211110	A) 110x30 cm; poťah: 3 mm konštrukcia: Ø 16 mm výška: 86 cm	1	4,200
2211109	B) 120x38 cm; poťah: 3 mm konštrukcia: Ø 16 mm výška: 90 cm	1	5,800

Žehliace dosky

eurogold®



kód	popis		
2211111	A) 120x38 cm; poťah: 8 mm konštrukcia: Ø 22 mm výška: 95 cm	1	6,200
2210433	B) 120x38 cm; poťah: 5 mm konštrukcia: Ø 22 mm výška: 95 cm	1	4,600
2211079	B) 120x38 cm; poťah: 8 mm konštrukcia: Ø 22+35 mm výška: 95 cm	1	5,550

Poťahy na dosku

eurogold®



kód	popis		
2211085	A) Alex 120x38 cm / elastický Termosenzitívny poťah s postavou muža	1	
2211086	B) Lora 120x38 cm / elastický Termosenzitívny poťah s postavou ženy	1	
2211080	C) 110x30 cm / 100% bavlna	1	
2211081	C) 120x38 cm / 100% bavlna	1	
2211082	C) 130x48 cm / 100% bavlna	1	
2211083	C) 120x38 cm / metalická bavlna	1	
2211084	C) 130x48 cm / metalická bavlna	1	

Sušiak na bielizeň, skladací

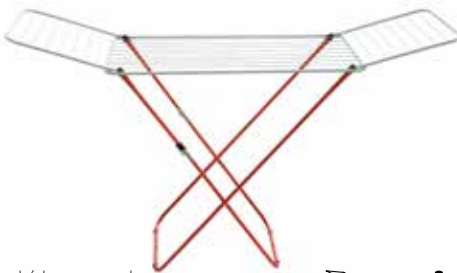

kód	popis		
217490	1800x550x1050 mm priestor na sušenie: 20m	6	2,350

Sušiak na bielizeň, nastaviteľný



kód	popis		
2210865	990-1760x595x905 mm	4	4,125

Sušiak na bielizeň, vaňový



kód	popis		
2210866	650x50x1280 mm	5	1,500

Sušiak na bielizeň



kód	popis		
2210867	630x505x1370 mm priestor na sušenie: 15m	5	2,600

Štipce na bielizeň



kód	popis		
221580	balenie 12ks	12	0,152

Sušiak na bielizeň



kód	popis		
2210864	515x355x165 mm priestor na sušenie: 3m	12	0,430

Lapač prachu



kód	popis		
221570	teleskopická rukoväť	1	0,219

Lapač prachu



kód	popis		
2210792	660x265 mm	1	0,150

Prachovka Monika



kód	popis		
312003	450x350 mm, flanelová	1	0,100

Handra Renáta



kód	popis		
312291	600x500 mm, netkaná	1	0,100
312480	700x500 mm, netkaná	1	0,100

Handra Jana



kód	popis		
312482	600x500 mm, netkaná	1	0,100
312459	650x500 mm, netkaná	1	0,100
312483	700x500 mm, netkaná	1	0,100

Prachovka Katka



kód	popis		
312479	400x350 mm, flanelová	1	0,100

Kôš na bielizeň



kód	popis		
2210924	50 lit. / nerezový	1	2,366

Kôš na bielizeň



NOVINKY

kód	popis		
254455	60 lit. / hnedý / 42x33x58 cm	1	1,745
254456	60 lit. / biely / 42x33x58 cm	1	1,745
2211130	60 lit. / antracitový / 42x33x58 cm	1	1,745
2211131	60 lit. / sivý / 42x33x58 cm	1	1,745

Košík uložený



kód	popis		
254457	60lit. / 3x šuflík / 37x37x60 cm	1	1,000

Kôš na bielizeň



kód	popis		
254369	310x260x110 mm	1	0,240
254370	470x320x140 mm	1	

Kôš na bielizeň



kód	popis		
2212000	300 mm	1	0,230

Kôš na bielizeň



kód	popis		
254371	61x40x23 cm	1	0,760

Kôš na bielizeň



kód	popis		
254436	40 lit., 500x400x320 mm		0,910

Kôš na bielizeň



kód	popis		
2210467	40 litrový, plast	1	0,825

Košík na štipce



kód	popis		
2210500	300x120 mm	1	0,116

Kôš na bielizeň



kód	popis		
254350	60 lit	1	2,050

Kôš na bielizeň, ratanový



kód	popis		
2211128	45 lit., 60x40x26 cm, sivý	13	1,200
2211129	45 lit., 60x40x26 cm, antracitový	13	1,200

Kôš na bielizeň



kód	popis		
2211132	25 lit., 59x39x24 cm, mix farieb	14	

Solvina Original



kód	popis		
312012	450 g	1	0,450

Kefka na nechty



kód	popis		
2210448	88 mm, plast	1	

Kefka na ruky



kód	popis		
2210447	85 mm, plast	1	

Kefa na čistenie kosačiek



kód	popis		
253172	285 mm	1	0,100

Kôš na odpad



kód	popis		
2210921	A) 38(50)x80 cm / zelený	1	2,500
2210919	B) 38(50)x80 cm / modré veko	1	2,500

Kôš na odpad



kód	popis		
2210922	A) 38(50)x80 cm / zelený	1	3,200
2210475	B) 38x86 cm / šedý / 100lit.	1	2,200
2210473	B) 38x86 cm / zelený / 100lit.	1	4,300

Výstražná tabuľa



kód	popis		
217150	"POZOR MOKRÁ PODLAHA" 60x30 cm	1	

Nádoba na recyklačný odpad



kód	popis		
254065	120 lit, modrá	1	9,200
254306	120 lit, červená	1	9,200
254015	120 lit, zelená	1	9,200
254016	120 lit, čierna	1	9,200
254008	120 lit, žltá	1	9,200
254266	120 lit, hnedá	1	9,200
254421	120 lit, biela	1	9,200
254009	240 lit, hnedá	1	16,000
254423	240 lit, červená	1	16,000
254174	240 lit, zelená	1	16,000
254044	240 lit, čierna	1	16,000
254422	240 lit, biela	1	16,000
254408	240 lit, modrá	1	16,000
254407	240 lit, žltá	1	16,000

Nádoba na odpad



kód	popis		
254013	A) KUKA • 110 lit, plechová	1	13,500
254012	B) KUKA • 110 lit, plastová	1	7,150

Zberač na odpadky



kód	popis		
217512	pinzetový / 1,5 m	1	

Kôš na recykláciu odpadu



kód	popis		
254542	3x50 lit., zelený, biely, žltý	3	4,000

Kôš na recykláciu odpadu



kód	popis		
254543	3x25 lit., biely, 75x37x50 cm	5	2,600
254544	3x25 lit., sivý, 75x37x50 cm	5	2,600

Stojan na triedenie odpadu



kód	popis		
221277	38x40x80 cm / 1x 120 lit. vreca	1	
221142	68x37x80 cm / 2x 120 lit. vreca	1	
221278	98x40x80 cm / 3x 120 lit. vreca	1	

Držiak vreca



kód	popis		
254524	120 lit.	1	
254525	240 lit.	1	

BASKETS AND CONTAINERS

Kôš na odpad



kód	popis		
254467	18 lit., 28x35x40 cm	1	1,320

Kôš na odpad



kód	popis		
254459	25 lit., modrý / Ø35x45,5 cm	1	
254458	25 lit., zelený / Ø35x45,5 cm	1	
254460	25 lit., šedý / Ø35x45,5 cm	1	
254463	45 lit., modrý / Ø45x56,5 cm	1	
254461	45 lit., zelený / Ø45x56,5 cm	1	
254462	45 lit., šedý / Ø45x56,5 cm	1	
254465	60 lit., modrý / Ø45x64,5 cm	1	
254464	60 lit., zelený / Ø45x64,5 cm	1	
254466	60 lit., šedý / Ø45x64,5 cm	1	

Kôš na odpad



kód	popis		
2210470	25 lit., modrý	1	0,980
2210471	25 lit., šedý	1	0,980
2210472	25 lit., zelený	1	0,979

Kôš na odpad s pedalom, nerez



kód	popis		
2210923	05 lit., biely povlak	12	1,216
2210929	05 lit., čierny povlak	12	1,216

Kôš na odpad s pedalom, nerez



kód	popis		
2212043	05 lit., imitácia medi	12	1,216

Kôš na odpad



kód	popis		
2210476	6 lit., pedálový, biely	1	0,790
2210402	18 lit., pedálový, biely	1	1,609
2210477	6 lit., pedálový, modrý	1	0,790
2210403	18 lit., pedálový, modrý	1	1,609

Kôš na odpad



kód	popis		
2210915	25 lit., modrý	1	0,900
2210916	25 lit., zelený	1	0,900
2210917	25 lit., oranžový	1	0,900
2210918	25 lit., červený	1	0,900

Kôš na odpad s pedalom



kód	popis		
2212066	05 lit., žltý	1	1,475

Kôš na odpad s pedalom



kód	popis		
2212065	05 lit., fialový	1	1,325

Kôš na odpad



kód	popis		
2212067	03 lit., pedálový, nerez	1	0,916
2210859	05 lit., pedálový, nerez	4	1,216
2210860	12 lit., pedálový, nerez	2	2,533
2210861	20 lit., pedálový, nerez	2	3,275
2210862	30 lit., pedálový, nerez	2	4,950

Kôš na odpad s popolníkom



kód	popis		
2212064	11 lit., nerez	1	1,825

Mlynček na výrobu cestovín



kód	popis		
801219	Materiál: pochromovaná oceľ	1	

- pre výrobu cestovín rôzneho druhu (špagety, tagliatelle, fetuchinne, lasagne a iné)
- maximálna šírka plátky: 15 cm
- 9 možností nastavenia hrúbky valkania cesta
- šírka cestovín: 2,0 a 6,6 mm

Mlynček na strúhanku a orechy



kód	popis		
801220	A) svorka na uchytenie	1	
801221	B) prísavka na uchytenie	1	

- materiál: zliatina
- 1 bubon na

Náhradne bubny k mlynčekom



kód	popis		
Bubny kompatibilné s mlynčkami 801220 a 801221			
801251	A) vhodný na jemné pomletie orechov, čokolády, tvrdého syru, zeleniny a ovocia	1	
801252	B) na mletie ovocia a zeleniny	1	
801253	C) na mletie ovocia, zeleniny a zemiakov	1	
801254	D) na rezanie na plátky zeleniny a ovocia	1	
801255	E) na strúhanie syra	1	

Struhák 4 stranný



kód	popis		
2212070	10x8x23 cm, CE	1	0,188

Struhák 6 stranný

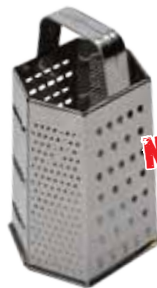

kód	popis		
2212071	13x11x22 cm, CE	1	0,216

Chlebník



kód	popis		
2212069	37x27x18 cm, nerez/plast	1	1,810

Chlebník



kód	popis		
2212068	39x28x16 cm, nerez/drevo	1	2,965

Stretch fólia Nano 200



kód	popis		
217495	300 m / 17 µm / číra	1	

Vrecia na odpad



kód	popis		
217853	120lit. / 70x110x0,06 / čierne	25	
217549	120lit. / 70x110x0,04 / čierne	25	
217930	120lit. / 70x110x0,04 / modré	25	
217119	030lit. / 50x060x0,04 / čierne	20	
217852	060lit. / 60x070x0,04 / čierne	20	
217296	060lit. / 60x070 / zaťahovacie č.	25	
217295	110lit. / 70x110 / zaťahovacie č.	25	

Vrecia na odpad



kód	popis		
217183	25lit. / 54x53 cm / transparent / s ušami / 8 µm / HDPE	25	
217184	35lit. / 60x55 cm / zelené / 8 µm / HDPE	25	
217182	35lit. / 60x55 cm / zelené / zaťahovacie / 13 µm	20	
217186	45lit. / 80x60 cm / fialové / zaťahovacie / 16 µm	20	
217450	60lit. / 80x65 cm / modré / s ušami / 20 µm	25	
217433	60lit. / 80x65 cm / modré / zaťahovacie / 20 µm	25	
217042	120lit. / 110x70 cm / čierne / zaťahovacie / 30 µm	25	

Zvonček bezdrôtový



kód	popis		
2210773	2xAAA niesu súčasťou bal.	30	0,183
2212081	napájanie 230V	30	0,150

Multifunkčná rohož



kód	popis		
2211076	0600x400 mm / polypropylén	1	
2210017	0700x900 mm / polypropylén	1	
2210243	1000x900 mm / polypropylén	1	

Rohožka Aztec



kód	popis		
2210608	400x600 mm / SK1	10	0,950

Rohožka Country



kód	popis		
2210615	450x750 mm / guma	10	2,700

Rohožka Oldstyle



kód	popis		
2210616	450x750 mm / guma	10	2,700

Rohožka Zebra



kód	popis		
2210617	400x600 mm / Zebra	10	1,400

Rohožka Brickwall



kód	popis		
2210609	450x750 mm / guma	10	2,600

Rohožka



kód	popis		
2210624	400x600 mm / akryl	10	1,000

Rohožka Lines



kód	popis		
2210612	400x600 mm / guma	10	1,810

Rohožka Arrows



kód	popis		
2210613	400x600 mm / guma / kokos	10	1,569

Rohožka FishScales



kód	popis		
2210614	400x600 mm / guma	10	2,051

Rohožka Church



kód	popis		
2210606	400x600 mm / panama	10	0,870

Rohožka Ornament



kód	popis		
2210605	450x750 mm / panama	10	1,520

Rohožka Vitajte



kód	popis		
2211112	400x600 mm / guma / kokos	10	1,000

Rohožka



kód	popis		
2210621	A) 400x600 mm / akryl	10	1,000
2210622	B) 400x600 mm / akryl	10	1,000

Rohožka



kód	popis		
2210611	A) 450x750 mm / guma	10	2,300
2210623	B) 400x600 mm / PP, guma	10	1,000

Rohožka Flowers



kód	popis		
2210607	450x750 mm / panama	10	1,100

Rohožka



kód	popis		
2210618	A) 450x750 mm / guma	10	2,010
2210620	B) 450x750 mm / guma	10	1,550

Rohožka Inca



kód	popis		
2210619	400x600 mm / guma	10	1,000

Rohožka Welcome



kód	popis		
2210604	400x600 mm / panama	10	0,870

Rohožka



kód	popis		
2210760	400x600 mm / SK1	10	0,950

Rohožka Welcome



kód	popis		
2210610	450x750 mm / guma	10	2,600

Rohožka



kód	popis		
2210761	400x600 mm / akryl	10	1,000

Rohožka



kód	popis		
2210762	400x600 mm / SK1	10	0,950

Rohožka



kód	popis		
2210763	400x600 mm / SK1	10	0,950

Rohožka



kód	popis		
2210757	A) White / 400x600 mm	25	0,736
2210758	B) Grey / 400x600 mm	25	0,736
2210759	C) Blue / 400x600 mm	25	0,736

Rohožka



kód	popis		
2210765	400x600 mm / panama	10	0,870

Rohožka



kód	popis		
2210766	400x600 mm / panama	10	0,870

Rohožka



kód	popis		
2210756	A) 400x600 mm	20	0,736
2210744	B) 420x670 mm	20	0,875

Rohožka



kód	popis		
2210741	400x600 mm	10	1,060
2210742	600x900 mm	10	2,260

Rohožka



kód	popis		
2210754	400x600 mm	25	0,688

Rohožka



kód	popis		
2210755	400x600 mm	25	0,688

Rohožka



kód	popis		
2210753	400x600 mm	25	0,688

Rohožka

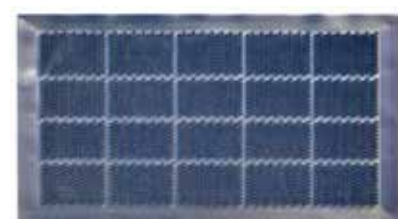

kód	popis		
2210743	650x900 mm	10	2,100

Rohožka



kód	popis		
2210738	400x600 mm	10	1,060
2210739	500x700 mm	10	1,500
2210740	600x900 mm	10	2,260

Rohožka



kód	popis		
2211135	600x900 mm, čierno-biela	10	1,785
2211137	600x900 mm, čierno-biela	10	1,785

Rohožka



kód	popis		
2211127	400x600 mm, červená	25	1,759
2211126	600x900 mm, červená	25	1,759

Rohožka



kód	popis		
2211139	600x900 mm, čierno-biela	25	1,759

Rohožka Halfmoon



kód	popis		
2212086	450x750 mm	10	1,280

Podložka pod stoličku



kód	popis		
2212087	900x1200 mm, transparentná	1	2,950

Rohožka



kód	popis		
2211138	600x900 mm, hnedá	25	1,785

Rohožka



kód	popis		
2211125	600x900 mm, modrá	25	1,759

Rohožka



kód	popis		
2211124	600x900 mm, čierno-šedá	25	1,759

Rohožka



kód	popis		
2210747	White / 400x600 mm	25	0,616

Rohožka



kód	popis		
2210751	White / 400x600 mm	25	0,748

Rohožka



kód	popis		
2210752	Brown / 400x600 mm	25	0,748

Rohožka



kód	popis		
2210748	Black with White / 400x600	25	0,748

Rohožka



kód	popis		
2210749	Grey / 400x600 mm	25	0,748
2211136	Grey / 600x900 mm	25	0,748

Rohožka



kód	popis		
2210750	Dark Brown / 400x600 mm	25	0,748

Rohožka



kód	popis		
2210745	Grey / 400x600 mm	25	0,616
2211133	Grey / 600x900 mm	25	0,672

Rohožka



kód	popis		
2210746	Blue / 400x600 mm	25	0,616
2211134	Blue / 600x900 mm	25	0,672

Lampáš LED, kovový



kód	popis		
2170540	A) napájanie 4xAAA	1	
2170539	B) napájanie 2xD	1	

16x LED diód v lampáši; Led žiarovka - výdrž cez 100 000h.
 Jas: 15-60 lumenov; Vypínač a prepínač pre nastavenie intenzity jasů; Batérie sú súčasťou balenia; Vodeodolný

Lampáš LED, drevo



kód	popis		
2170322	19x19x36 cm / 3xAAA	1	1,460

Lampáš LED, drevo



kód	popis		
2170323	17x17x33 cm / 3xAAA	1	1,310

Lampáš LED, drevo



kód	popis		
2170324	16x16x35 cm / 3xAAA	1	1,260

Lampáš LED, plast



kód	popis		
2170321	14x14x30 cm / 3xAAA	1	1,000

Lampáš LED, kov



kód	popis		
2170320	14x14x30 cm / 3xAAA	1	1,225

Petrolejový lampáš



kód	popis		
217466	A) 377 mm	1	0,670
2170033	A) sklo náhradné	100	0,104
217467	B) 348 mm	12	1,016
2170032	B) sklo náhradné	24	0,114

Petrolejový lampáš

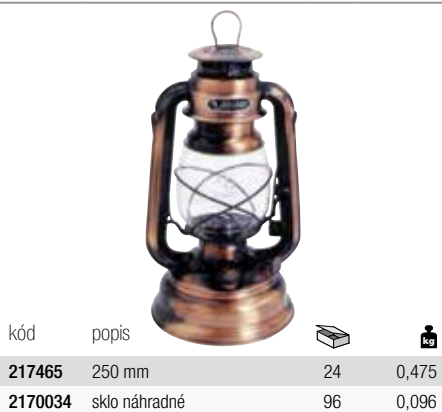

kód	popis		
217465	250 mm	24	0,475
2170034	sklo náhradné	96	0,096

Lampáš na sviečku



kód	popis		
217974	A) 210 mm	24	0,516
2170036	A) sklo náhradné	1	0,071
217448	B) 190 mm	24	0,258

Petrolejový lampáš

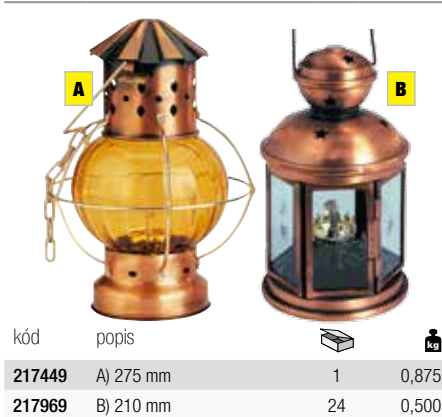

kód	popis		
217449	A) 275 mm	1	0,875
217969	B) 210 mm	24	0,500

Knôt Fire, guľatý



kód	popis		
217455	2,00 mm / 1m	1	
217456	3,20 mm / 1m	1	
217454	5,50 mm / 1m	1	
217453	9,00 mm do pochodne / 1m	1	

Knôt Fire, plochý

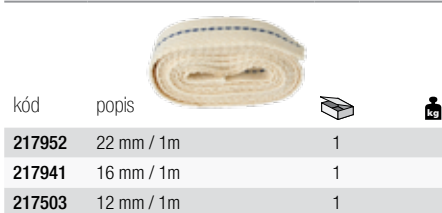

kód	popis		
217952	22 mm / 1m	1	
217941	16 mm / 1m	1	
217503	12 mm / 1m	1	

Knôt

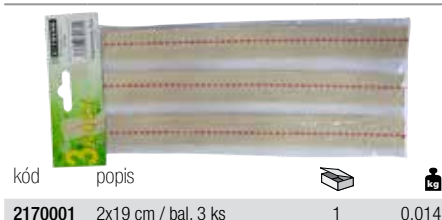

kód	popis		
2170001	2x19 cm / bal. 3 ks	1	0,014

LANÁ A MOTÚZY / ROPES AND STRINGS

Lano PPV Kružberg, 100 m



kód	popis		
432144	06 mm	1	
432121	08 mm	1	

Lano PP

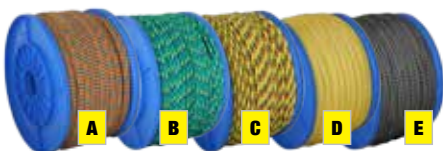

kód	popis		
432156	A) 04 mm, modré, 200 m, nos. 76 kg	1	
432161	A) 06 mm, modré, 90 m, nos. 173 kg	1	
432160	B) 05 mm, zelené, 130 m, nos. 119 kg	1	
432157	C) 05 mm, žlté, 130 m, nos. 119 kg	1	
432155	D) 03 mm, žlté, 380 m, nos. 43 kg	1	
432154	E) 03 mm, čierne, 380 m, nos. 43 kg	1	

Lano PP



kód	popis		
432149	06 mm, 90 m, PP, nos. 122 kg	1	
432150	08 mm, 90 m, PP, nos. 203 kg	1	
432151	10 mm, 60 m, PP, nos. 284 kg	1	
432152	12 mm, 40 m, PP, nos. 403 kg	1	

Lano nylonové



kód	popis		
432162	03 mm, biele, 380 m, nos. 144 kg	1	
432163	04 mm, biele, 200 m, nos. 259 kg	1	
432164	05 mm, biele, 130 m, nos. 403 kg	1	
432165	06 mm, biele, 90 m, nos. 576 kg	1	
432166	08 mm, biele, 90 m, nos. 1031 kg	1	

Lanko štartovacie



kód	popis		
432183	3.00 mm, 100 m, PE	1	
432184	3.50 mm, 100 m, PE	1	
432185	4.00 mm, 100 m, PE	1	

Lano gumové / Popruh PP

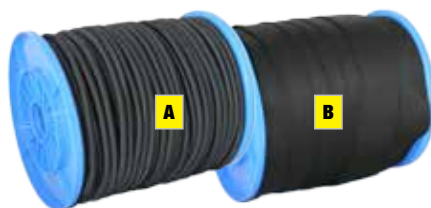

kód	popis		
432175	A) 05 mm, 140 m, nos. 45 kg	1	
432176	A) 06 mm, 90 m, nos. 90 kg	1	
432177	A) 08 mm, 90 m, nos. 120 kg	1	
432178	A) 10 mm, 60 m, nos. 220 kg	1	
432179	B) 25 mm, čierny, 70 m, 190 kg	1	
432180	B) 30 mm, čierny, 60 m, 230 kg	1	
432181	B) 35 mm, zelený, 70 m, 270 kg	1	
432182	B) 50 mm, čierny, 50 m, 370 kg	1	

Lano konopné



kód	popis		
432066	08 mm, bal. 100 m	1	0,050
432067	10 mm, bal. 100 m	1	0,060
432068	12 mm, bal. 100 m	1	0,070
432069	14 mm, bal. 100 m	1	0,080
432070	20 mm, bal. 45 m	1	0,090
432071	24 mm, bal. 30 m	1	0,100
432111	30 mm, bal. 20 m	1	0,120

Lano PP, 20 m



kód	popis		
432072	05 mm	50	0,220
432073	06 mm	50	0,300
432074	08 mm	20	0,570
432107	10 mm	20	0,820

Ťažné lano



kód	popis		
432059	4 m / max. 2 tony	10	0,900

Ťažné lano



kód	popis		
432054	L-4 m / nosnosť 2 tony	1	
432109	L-4 m / nosnosť 3 tony	1	

Laná

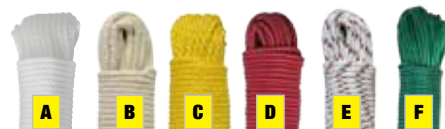

kód	popis		
217632	A) PP, biela, 20 m/4 mm	50	0,147
217633	B) Bavlna, biela, 20 m/4 mm	50	0,136
217634	C) PE, žltá, 20 m/4 mm	50	0,146
217635	D) PVC, červená, 20 m/4 mm	50	0,331
217636	E) PP, special, 20 m/4 mm	50	0,145
217637	F) oceľ, zelená, 4,00 mm x 100 m	25	0,540
217638	F) PVC, zelená, 6,35 mm x 100 m	25	0,755

Lano jutové, OPRAT Ø12 mm



kód	popis		
432048	06 m	1	0,485
432049	08 m	1	0,648
432050	10 m	1	0,795
432051	12 m	1	0,945
432052	15 m	1	1,195

Lano jutové, PAVUZNÍK Ø20 mm



kód	popis		
432044	10 m	1	1,600
432045	12 m	1	1,900
432046	15 m	1	2,400

Motúz



kód	popis		
217174	A) 080 g / biely	5	0,090
217116	A) 100 g / biely	5	0,110
217550	A) 200 g / biely	5	0,220
217104	B) POP / 1kg / modrý	1	1,000
217007	B) POP / 5kg / biely	1	5,000

Motúz



kód	popis		
217639	A) 90 m, Sisal	50	0,240
217642	B) 130 m, Bavlna 7,6 cm	50	0,217
217543	C) 60 m	100	0,150
217546	C) 76 m	100	0,170
217544	D) 60 m	100	0,150
217548	E) 45 m	100	0,076
217547	F) 080g	5	0,090
217552	F) 100g	5	0,110
217504	F) 200g	5	0,440
217631	G) 60 m / 2ks v balení	100	0,069

Teplomer STEEL

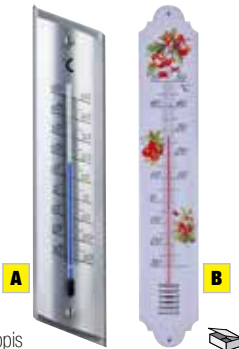

kód	popis		
221972	A) 230x53x16 mm	10	0,250
221970	B) 500x90x15 mm	20	0,190

Teplomer

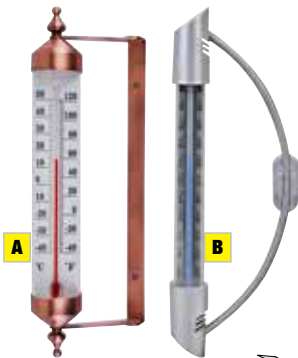

kód	popis		
221975	A) 265x80x40 mm	50	0,180
221974	B) 233x85x25 mm	10	0,125

Teplomer, drevený

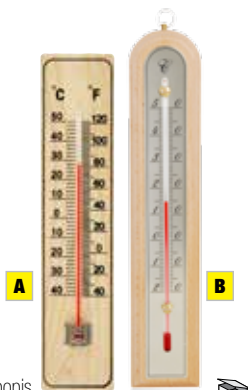

kód	popis		
221953	A) 220x50x13 mm	20	0,100
221155	B) 260x50x18 mm	10	0,187

Teplomer WALLTUBE



kód	popis		
221973	300x122x50 mm	8	0,275

Teplomer DECORA

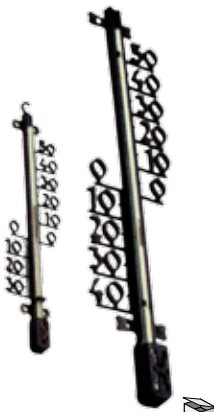

kód	popis		
221960	255x60x15 mm	10	0,030
221962	470x110x25 mm	10	0,125

Teplomer

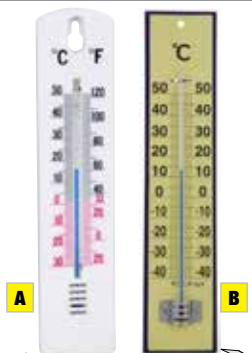

kód	popis		
221969	A) 400x65x10 mm	20	0,108
221156	B) 450x80x20 mm	10	0,200

Teplomer



kód	popis		
221158	A) 530x220x10 mm	10	0,625
221952	B) 162x56x20 mm	20	0,045

Teplomer bazénový



kód	popis		
221157	195x50x70 mm / plast	8	0,150

Teplomer



kód	popis		
221194	620x90 mm, ABS	8	1,070

Teplomer



kód	popis		
221154	A) 380x88x35 mm / Alu	10	0,260
221968	B) 250x55x12 mm	20	0,068

Meteostanica



kód	popis		
2211143	13x10x2.5 cm		

- Dátum, čas a teplota
- Obsahuje funkciu rádiiovi riadeného času
- Maximálny dosah signálu vo voľnom priestore: 60 metrov
- Symboly predpovede počasia: slnečno, čiastočne zamračené, zamračené, dažďovo, búrky

Meteostanica



kód	popis		
2211144	10x7x2 cm		

- Dátum čas a teplota
- Zobrazenie maximálnej a minimálnej teploty od posledného resetu
- Maximálny dosah vo voľnom priestore: 60 metrov
- Presnosť merania: +/- 1°C pri rozsahu 0°C

SCHRÁNKY / POST BOXES

Poštová schránka MODERN



kód	popis		
217612	biela / 365x365x133 mm	5	2,600
217613	hnedá / 365x365x133 mm	5	2,600

Poštová schránka ROMANTIC



kód	popis		
252104	360x355x100 mm	5	1,667



Poštová schránka NAPOLEON



kód	popis		
217851	biela / 365x365x135 mm	5	2,600
217858	hnedá / / 365x365x135 mm	5	2,600

Poštová schránka NESTOR



kód	popis		
252243	450x370x100 mm, hnedeá	5	2,000

Schránka FLATBLOCK



kód	popis		
217733	310x260x090 mm, hnedeá	6	1,900
217533	310x360x090 mm, hnedeá	6	1,900

Poštová schránka HUBERT



kód	popis		
217859	biela / 445x365x133 mm	1	3,400
217860	hnedeá / 445x365x133 mm	5	3,400

Poštová schránka NESTOR



kód	popis		
252190	biela / 440x370x100 mm	5	1,800
252243	hnedeá / 440x370x100 mm	5	1,800



kód	popis		
217608	biela / 465x365x135 mm	1	3,800
217879	hnedeá / 465x365x135 mm	1	3,800

Schránka na kľúče



kód	popis		
221815	48 háčikov	12	1,500

Vešiak na kľúče



kód	popis		
2212074	28x25x8 cm., zelený	1	0,756

Schránka na kľúče



kód	popis		
221362	250x180x90 mm	8	1,150
221895	250x200x90 mm	8	1,150
221896	300x230x90 mm	4	1,600
221897	300x240x90 mm	5	1,750

DOMÁCNOSŤ

Guma upínacia Ø8

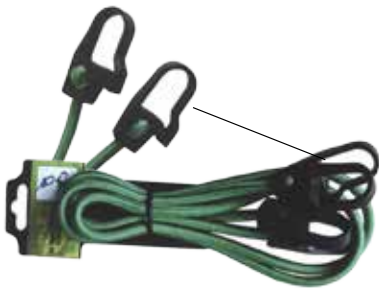

kód	popis		
217630	2x1 m	50	0,140

Guma upínacia Ø8



kód	popis		
217628	1 m, Ø 8mm	50	0,200

Guma upínacia Ø8



kód	popis		
217740	2x1 m, Ø8mm	40	0,190



kód	popis		
217999	8x900 mm	20	0,150

Guma upínacia Ø8



kód	popis		
217736	2x1 m, nosnosť 70 kg	20	0,200

Guma upínacia Ø8



kód	popis		
217627	4x1 m, Ø 8mm, nosnosť 70 kg	30	0,400

Guma upínacia Ø8



kód	popis		
217887	1 m	10	0,167

Guma upínacia Ø8



kód	popis		
217828	2x1 m	24	0,140

Guma upínacia s karabinkou Ø10



kód	popis		
217629	1 m, nosnosť 120 kg	10	0,140

Guma upínacia a pásy



kód	popis		
217563	L-5 m	10	1,800

Guma upínacia Ø6

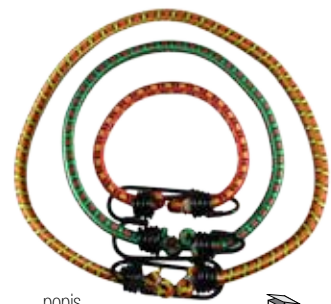

kód	popis		
217498	30-50-60 cm	50	0,111

Guma upínacia Ø6

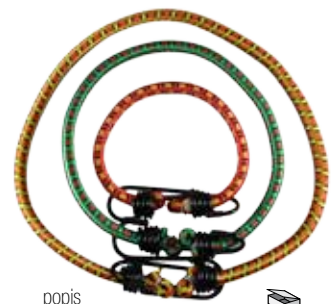

kód	popis		
217788	6 ks / 30-50-60 cm	50	0,236

Guma upínacia Ø8



kód	popis		
217739	30-45-60 cm	50	0,225

Guma upínacia



kód	popis		
217125	2x0.4 m, 2x0.6 m 2x0.8 m, 2x1.0 m nosnosť 70 kg	10	0,700

Upínací popruh • 2"



kód	popis		
217625	L-8 m, nosnosť 1000 kg	4	3,500

Sada upínacích popruhov • 2"



kód	popis		
217623	L-6 m; 2ks, nosnosť 480 kg	4	3,500

Sada upínacích popruhov • 1"



kód	popis		
217622	L-4,5 m; 2ks, nosnosť 125 kg	10	1,200

Upínací popruh • 2"



kód	popis		
217620	L-6 m, nosnosť 480 kg	10	1,900

Upínací popruh • 1"

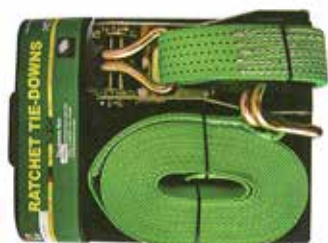

kód	popis		
217421	L-4,5 m, bal. 4 ks, nosnosť 1300 kg	4	2,750

Sada upínacích popruhov



kód	popis		
2170150	25 mm / L-1.8 m / 2ks	6	1,000

Sada upínacích popruhov • 1"



kód	popis		
217626	L-4,5 m; 4 ks, nosnosť 125 kg	6	2,667

Upínací popruh • 1"



kód	popis		
217624	L-4,5 m, nosnosť 125 kg	20	0,650

Sadaupínacích popruhov • 1 1/4"

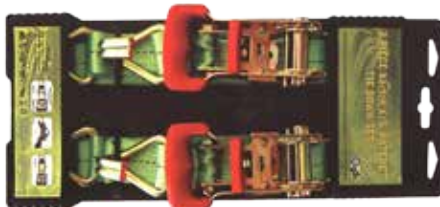

kód	popis		
217621	L-4,5 m; 2ks, nosnosť 400 kg	10	1,170

Upínací popruh • 1 1/4"



kód	popis		
217451	L-5 m, bal. 2 ks, nosnosť 400 kg	6	2,250

Upínací popruh



kód	popis		
2170151	50 mm / L-8 m	8	2,375

Upínací popruh



kód	popis		
217586	L-5 m, nosnosť 1000 kg		

Upínací popruh



kód	popis		
217601	L-6 m, nosnosť 1200 kg	10	2,000

Upínací popruh



kód	popis		
217499	L-5 m, nosnosť 3000 kg	10	2,100

Upínací popruh



kód	popis		
217584	L-6 m, nosnosť 5000 kg		
217583	L-8 m, nosnosť 5000 kg		

Vodítko na psa



kód	popis		
217676	A) 10kg / 5m	1	0,166
2170153	B) 25kg / 5m	36	0,333
2170152	C) 10kg / 5m	72	0,222
2170154	D) 8kg / 3m, MINI	36	0,194

Vozík RAPID 6



kód	popis		
217991	RDV6 • 80 kg, 618x418x232 mm • koleso 290 mm, plné	1	3,000
217294	koleso náhradné • plné		

Vozík POPULAR



kód	popis		
217171	RDV3 • 50 kg, 618x418x232 mm • koleso 230 mm, plné	1	3,000
217428	koleso náhradné • plné	1	

Vozík RAPID 4



kód	popis		
217990	RDV4 • koleso 290 mm, nafukovacie 80 kg, 618x418x232 mm	1	3,000
217473	náhradné koleso, bez duše	1	

Vozík RAPID 5



kód	popis		
217611	RDV5 • koleso 240 mm, plné 80 kg, 618x418x232 mm	1	3,000
217429	koleso náhradné • plné	1	

Vozík TRANSPORT



kód	popis		
212534	800x1080x225 mm, komplet	1	5,000
221267	rám bez kolies	1	
217849	duša na koleso, náhradná	1	
217850	plášť na koleso, náhradný	1	
222441	koleso neobuté	1	
217382	koleso obuté	1	

Vozík PEGAS

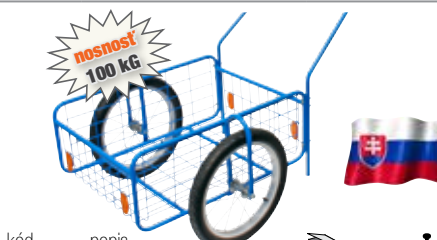

kód	popis		
217170	Vozík RDV7 • 100 kg, 618x418,232 mm, koleso nafukovacie	1	3,000
212755	Koleso PEGAS obuté	1	

Vozík FAVORIT



kód	popis		
2170030	447x647x272 mm koleso: 12", nafukovacie nosnosť: 120 kg	1	3,000

Vozík POPULAR



kód	popis		
2170029	400x600x247 mm koleso: 20 mm, plné nosnosť: 80 kg	1	3,000

Vozík HANDTRUCK



kód	popis		
2170770	100 kg, 618x418x232 mm koleso plné	1	
2170771	koleso náhradné • plné	1	

Vozík VICTOR



kód	popis		
2170507	• 100 kg, 650x480x290 mm • koleso nafukovacie • farba zelená	1	3,000
2170508	koleso náhradné	1	
2170509	náhradná duša pre koleso	1	
2170510	náhradný plášť pre koleso	1	
2170511	náhradná oska pre koleso	1	

Vozík OPTIMUS



kód	popis		
212543	Vozík • 240 kg, 890x630x250 mm, koleso nafukovacie 20x2.125" drevená korba hrúbky 18 mm	1	5,000
2170777	koleso náhradné	1	

Plošinový vozík



kód	popis		
222301	Nosnosť: 150kg 4x kolieska, 2x otočné, 2x pevné Váha: 8.4kg Rozmery nakladacej plošinky: Výška: 820, Dĺžka: 735, Šírka: 475	1	8,500

Vozík prepravný



kód	popis		
2170073	max. 150kg / 4 kolieska	1	7,200

Vozík prepravný skladací



kód	popis		
2170071	B) max. 125kg / 2 kolieska	1	7,900

Vozík prepravný skladací



kód	popis		
2170072	max. 100kg / 2 kolieska	1	5,875

Vozík MASSMOVER, zinok



kód	popis		
2170027	A) 470x470x1090 mm nosnosť: 200 kg	1	5,000
2170028	B) 570x500x1130 mm nosnosť: 250 kg	1	5,000

Vozík na vrecia HT2500



kód	popis		
217416	A) 150 kg	1	9,500
217868	B) koleso plné	1	2,000
217970	B) koleso nafukovacie	1	2,000
217973	C) náhradná duša		
217452	náhradný plášť		

Vozík prepravný skladací



kód	popis		
2170070	max. 060kg / 2 kolieska	4	3,670



Kolieska so štandardnou gumovou obručou - disk z polypropylénu

Int. kód	Ø kolesa	šírka kolesa	Ø náboja	dĺžka náboja	ložisko	vyloženie	rozteč	Ø upínania	príruba
A) 2170812	75 mm	23 mm	12 mm	30 mm	ihlové	-	-	-	-
A) 2170813	100 mm	27 mm	12 mm	40 mm	ihlové	-	-	-	-
A) 2170814	125 mm	34 mm	15 mm	40 mm	ihlové	-	-	-	-
B) 2170803	75 mm	23 mm	12 mm	30 mm	ihlové	32 mm	62x50 mm	8,5 mm	84x72 mm
B) 2170804	100 mm	27 mm	12 mm	40 mm	ihlové	37 mm	80x60 mm	9 mm	102x84 mm
B) 2170805	125 mm	34 mm	15 mm	40 mm	ihlové	35 mm	80x60 mm	9 mm	102x84 mm
C) 2170806	75 mm	23 mm	12 mm	30 mm	ihlové	32 mm	62x50 mm	8,5 mm	84x72 mm
C) 2170807	100 mm	27 mm	12 mm	40 mm	ihlové	37 mm	80x60 mm	9 mm	102x84 mm
C) 2170808	125 mm	34 mm	15 mm	40 mm	ihlové	35 mm	80x60 mm	9 mm	102x84 mm
D) 2170809	75 mm	23 mm	12 mm	30 mm	ihlové	-	62x50 mm	8,5 mm	84x72 mm
D) 2170810	100 mm	27 mm	12 mm	40 mm	ihlové	-	80x60 mm	9 mm	102x84 mm
D) 2170811	125 mm	34 mm	15 mm	40 mm	ihlové	-	80x60 mm	9 mm	102x84 mm

Kolieska so štandardnou gumovou obručou - disk oceľový plech, pozinkovaný + nábytkové gumové

Int. kód	Ø kolesa	šírka kolesa	Ø náboja	dĺžka náboja	ložisko	vyloženie	rozteč	Ø upínania	príruba
E) 2170800	75 mm	23 mm	12 mm	30 mm	ihlové	-	-	-	-
E) 2170801	100 mm	27 mm	12 mm	40 mm	ihlové	-	-	-	-
E) 2170802	125 mm	34 mm	15 mm	40 mm	ihlové	-	-	-	-
F) 2170791	75 mm	23 mm	12 mm	30 mm	ihlové	32 mm	62x50 mm	8,5 mm	84x72 mm
F) 2170792	100 mm	27 mm	12 mm	40 mm	ihlové	37 mm	80x60 mm	9 mm	102x84 mm
F) 2170793	125 mm	34 mm	15 mm	40 mm	ihlové	35 mm	80x60 mm	9 mm	102x84 mm
G) 2170794	75 mm	23 mm	12 mm	30 mm	ihlové	32 mm	62x50 mm	8,5 mm	84x72 mm
G) 2170795	100 mm	27 mm	12 mm	40 mm	ihlové	37 mm	80x60 mm	9 mm	102x84 mm
G) 2170796	125 mm	34 mm	15 mm	40 mm	ihlové	35 mm	80x60 mm	9 mm	102x84 mm
H) 2170797	75 mm	23 mm	12 mm	30 mm	ihlové	-	62x50 mm	8,5 mm	84x72 mm
H) 2170798	100 mm	27 mm	12 mm	40 mm	ihlové	-	80x60 mm	9 mm	102x84 mm
H) 2170799	125 mm	34 mm	15 mm	40 mm	ihlové	-	80x60 mm	9 mm	102x84 mm
I) 2170789	25 mm	14 mm	4 mm	15,5 mm	klzné	-	35 mm	4 mm	45x19 mm
J) 2170790	50 mm	18 mm	6 mm	22 mm	klzné	-	54 mm	6,2 mm	68x25 mm

Rebrík kĺbový



kód	popis / výška v cm	obrázok	kg
251339	priečky 4x3 / 3,54m	1	6,000

Rebrík kĺbový • bez plošiny



kód	popis	Vmax	Vmin	kg
251260	4x3 priečkový + plošina	3,5 m	0,9 m	17,600

Rebrík teleskopický, Alu



kód	popis	Vmax	Vmin	kg
251266	13 priečkový	0,9 m	3,85 m	17,000

Rebrík jednoduchý



kód	popis	Vmax	kg
251063	07 priečkový	1,99 m	2,700
251064	09 priečkový	2,56 m	3,400
251066	10 priečkový	2,84 m	3,800
251039	11 priečkový	3,13 m	4,300
251084	14 priečkový	3,98 m	6,400

Pracovná plošina, hliníková

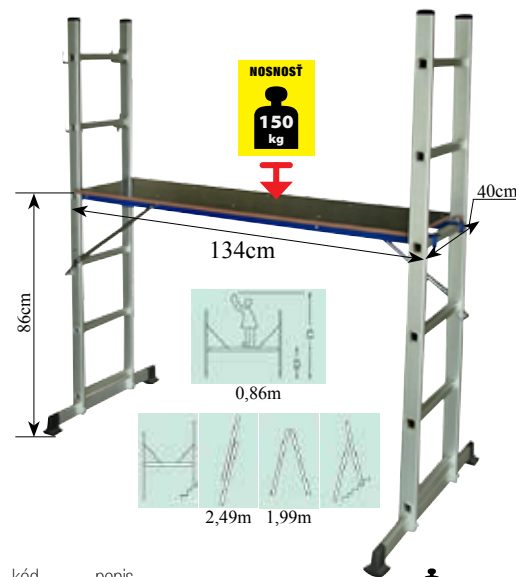

kód	popis	kg
251269	2x6 priečkový, plošina 120x40cm	18,900

Pracovná plošina, hliníková; EN1004

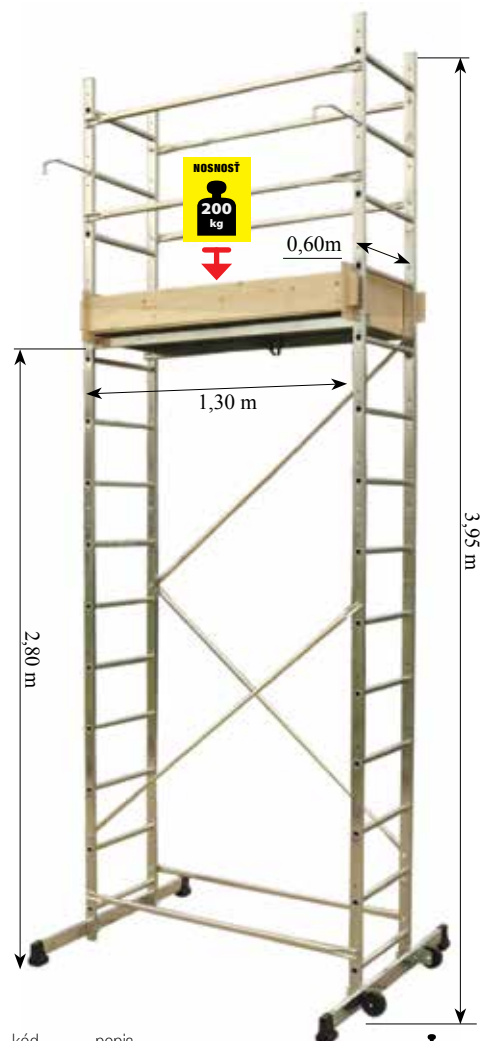

kód	popis	kg
218038	2,72x0,54x0,13 m	34,000

Pracovná výška 3-5 m. Obsahuje háky na zaistenie lešenia. Plošina je vhodná aj do interiéru. Vodoodolná. Úprava na schody. Hmotnosť plošiny 34kg. Príslušenstvo 9kg.



Rebrík Telescop22

kód	Vmax	Vmin	š	⚠	📦	kg
251249	2400 mm	730 mm	470 mm	12 kg	1	12,000
251250	3000 mm	780 mm	470 mm	16 kg	1	18,000

Jednoduché zloženie zatiahnutím za bezpečnostné poistky.



Praktický, flexibilný a výborne skladovateľný rebrík



Jednoduché výškové nastavenie.



Rebrík Telescop20

kód	Vmax	Vmin	š	⚠	📦	kg
251246	2600 mm	730 mm	470 mm	7,4 kg	1	8,500
251247	3200 mm	780 mm	470 mm	10 kg	1	11,000
251248	3600 mm	890 mm	470 mm	13 kg	1	15,000

Viacúčelový rebrík



Je ho možné využiť ako oporný rebrík alebo ako rebrík stojanový.

Jeden diel rebríku je vybavený širokou priečnou traverzou pre bezpečnejšie státie

EN 131:2017



Hák pre vešanie, ktorý zároveň slúži ako zábrana voči vybraníu jednorebríka.



Optimálna stabilita vďaka širokej traverze

kód	popis	Vmax	Vmin	kg
251067	07 priečkový	4.00 m	2.05 m	10,000
251068	08 priečkový	5.10 m	2.30 m	12,300
251069	09 priečkový	5.40 m	2.60 m	13,400
251071	11 priečkový	6.50 m	3.15 m	17,500

Schodky oceleové



150 kg

kód	popis		
251290	2 priečkový	1	5,625
251291	3 priečkový	1	8,000

Schodky oceleové



120 kg

kód	popis	
251271	2 priečkový	5,375
251272	3 priečkový	9,000

Schodky oceleové



120 kg

kód	popis		
251292	2 priečkový / 46x56x081 cm	6	4,160
251293	3 priečkový / 46x75x104 cm	4	6,250
251351	4 priečkový / 46x85.5x128.5 cm	3	7,500

Schodky oceleové

eurogold®



120 kg

kód	popis / výška v cm		
251323	3 priečkové / 130 cm	1	4,440
251324	4 priečkové / 153 cm	1	5,300
251325	5 priečkové / 175 cm	1	6,100
251326	6 priečkové / 198 cm	1	7,000
251327	7 priečkové / 221 cm	1	8,300
251328	8 priečkové / 245 cm	1	9,600

Schodky hliníkové

ALVE



120 kg

kód	popis / výška v cm		
251022	3 priečkové / 130 cm	1	3,000
251023	4 priečkové / 153 cm	1	3,200
251024	5 priečkové / 175 cm	1	3,800
251025	6 priečkové / 198 cm	1	4,200
251026	7 priečkové / 221 cm	1	4,500
251027	8 priečkové / 245 cm	1	4,800

Schodky hliníkové s poličkou

ALVE



150 kg

kód	popis / výška v cm		
251017	3 priečkové / 129 cm	1	3,600
251019	4 priečkové / 152 cm	1	4,200
251056	5 priečkové / 175 cm	1	4,700
251101	6 priečkové / 198 cm	1	5,400

Schodky hliníkové, obojstranné

ALVE



150 kg

kód	popis / výška v cm		
251126	2 priečkové / 041 cm	1	1,600
251127	3 priečkové / 063 cm	1	2,400
251128	4 priečkové / 086 cm	1	3,200
251129	5 priečkové / 109 cm	1	4,000
251130	6 priečkové / 132 cm	1	4,900
251220	7 priečkové / 155 cm	1	6,200
251131	8 priečkové / 178 cm	1	7,200

Rebrík drevený

150 kg



kód	popis / výška v cm	1	kg
251105	4 priečkový/ 134 cm	1	7,000
251106	5 priečkový/ 165 cm	1	8,000
251107	6 priečkový/ 196 cm	1	9,000
251108	7 priečkový/ 227 cm	1	10,000
251109	8 priečkový/ 258 cm	1	13,000
251110	9 priečkový/ 289 cm	1	15,000

Rebrík drevený maliarský

150 kg



kód	popis / výška v cm	1	kg
251028	4 priečkový/ 134 cm	1	7,200
251030	5 priečkový/ 165 cm	1	8,200
251031	6 priečkový/ 196 cm	1	9,200
251035	7 priečkový/ 227 cm	1	10,200
251036	8 priečkový/ 258 cm	1	13,200

Kovanie rebríkové



kód	popis	20	kg
252199	jednoduché, 2 x pánty	20	0,399
252074	maliarske, 2 x pánty	26	0,610

Stojan na bicykel



kód	popis	2	kg
2170098	3 pozície	2	4,500

Skrinka



kód	popis	1	kg
212935	1x polica / 65x37x93 cm	1	
212936	4x polica / 65x37x173 cm	1	

Regál plastový



kód	popis	4	kg
239396	60x30x130 cm, plast, 4 police	4	4,380
239397	60x30x172 cm, plast, 5 políc	4	5,380

Regál kovový



kód	popis	1	kg
2210779	1800x900x400 mm, max. 175 kg	1	
2210778	1800x900x450 mm, max. 265 kg	1	

Vešiak

NOVINKA



kód	popis	1	kg
217540	40 cm, 6x vešiak	1	

Držiak na náradie



kód	popis	1	kg
221444	6x vešiak	1	0,200

Držiaky na náradie



kód	popis	1	kg
217541	5x vešiak	1	

Držiak na náradie



kód	popis	1	kg
217541	40 cm	1	

Držiak na náradie



kód	popis	20	kg
2110231	Alu, plast / 4 pozície, (2-3 cm)	20	0,550

Sada skladovacia na náradie

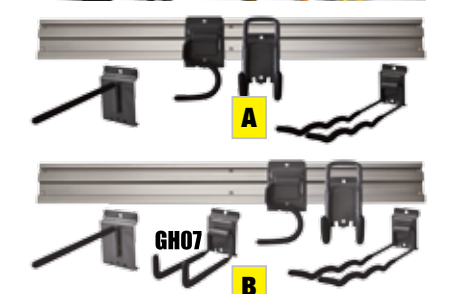

kód	popis	1	kg
222515	A) bez háku GH07 850x230x220 mm, 5ks kofajnička: 1200 mm	1	15,000
222513	B) s hákom GH07 1250x230x220 mm, 6ks kofajnička: 800 mm	1	18,000



Skvelý spôsob skladovania v dielňach i domácnostiach. Vhodné pre záhradné náradie, ručné náradie, káble, hadice, vodováhy, metly, lopaty, rebríky... Upevňovacie skrutky a hmoždinky sú súčasťou balenia. Každý hák má nosnosť do 11,5kg. Hák GH07 udrží až do 23 kg. Celková nosnosť je max. 120 kg



Nákupný vozík Alfred

Nákupný vozík Zoltan



kód popis  
 2170601 nos. 25 kg, 35x30x94 cm



Nákupný vozík Bartos



kód popis  
 2170595 nos. 30 kg, 35x30x96 cm

Nákupný vozík Ferenc



kód popis  
 2170598 nos. 30 kg, 35x30x96 cm

Nákupný vozík Demeter



kód popis  
 2170597 nos. 30 kg, 35x30x96 cm



Sieť na batožinu



kód popis  
 432088 2,5x3,5 m / zelená /
 hrubka siete: 3 mm /
 oko: 45x45 mm

Nákupný vozík Gabor



kód popis  
 2170599 nos. 25 kg, 35x30x94 cm

Nákupný vozík Markus



kód popis  
 2170600 nos. 25 kg, 35x30x94 cm

Pasce proti hmyzu



kód	popis	ks	kg
2212006	A) di martino / na PET fľašu / bal. 3ks		
2170882	B) Elektrická pasca / Rozmer: 23x12 cm Napájanie: 230V/50Hz		
2210727	C) Elektrická pasca Rozmery: 28x16 cm Napájanie: 230V/50Hz Špeciálne navrhnutá nádoba pre udržanie zachyteného hmyzu	0,460	

Elektrická pasca proti hmyzu



kód	popis	ks	kg
2170613	Napájanie: 230V/50Hz Rozmery: 105x65x90 mm	0,070	

Odpudzovač hmyzu



kód	popis	ks	kg
2210728	Frekvencia: 5000 Hz - 7000 Hz Napájanie: 1,5 V (1 x AAA batéria) Životnosť batérie: 800 hodín Rozmery: 63mm x 44mm x 26mm Pokrytie: 12 m ²	0,083	

Solárny odpudzovač hlodavcov



kód	popis	ks	kg
2170043	pokrytie až do 650 m ²	12	0,500

Napájanie prostredníctvom integrovaného solárneho článku. Dobíja sa i pri slabom slnečnom žiarení a v zime. Kovový špic so zvukovým odplašovačom vydáva zvukový signál každých 30 sekúnd.

Pasca na hlodavce

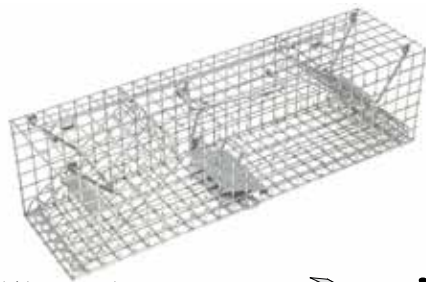

kód	popis	ks	kg
221092	50x14x14 cm	1	1,230
221093	63x16x20 cm	1	1,860
221094	90x18x23 cm	1	2,920

Magnetická sieť proti hmyzu



kód	popis	ks	kg
2210567	A) bez vzoru, 218x96 cm	24	0,420
22109560	B) vzor motýľ, 218x96 cm	24	0,420

Sieť proti hmyzu, hliníkový rám

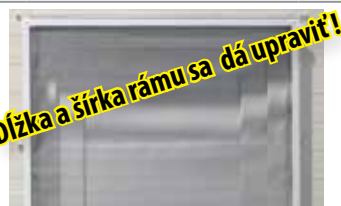

kód	popis	ks	kg
221788	150x120 cm, na okno	10	1,700
221789	210x100 cm, na dvere	10	2,140

Sieť proti hmyzu



kód	popis	ks	kg
221652	150x130 cm, biela	20	0,105
221654	150x180 cm, biela	20	0,130
221655	150x090 cm, biela	20	0,090
221485	220x065 cm, biela, balkónová	20	0,150
221656	220x075 cm, biela, balkónová	20	0,150
2210649	150x090 cm, čierna	20	0,095
2210650	150x130 cm, čierna	20	0,110
2210651	150x180 cm, čierna	20	0,135
2210652	220x065 cm, čierna, balkónová	20	0,155
2210653	150x090 cm, hnedá	20	0,095
2210654	150x130 cm, hnedá	20	0,110
2210655	150x180 cm, hnedá	20	0,135
2210656	220x065 cm, hnedá, balkónová	20	0,155

Pasca na hlodavce



kód	popis	ks	kg
2170897	40x16 cm / 2.0 mm	1	1,400

Doska lepová na myši a potkany



kód	popis	ks	kg
090035	37.5x24.5 mm	1	0,100

Pasca mechanická na krtek



kód	popis	ks	kg
2170894	A) 14x11 cm / zinok	1	0,245
2170895	B) 21x8,5 cm / zinok	1	0,400
2170893	C) 21x11 cm / zinok	1	0,355

Pasca na krtek



kód	popis	ks	kg
2170896	A) 25x5,6 cm / plastová	1	0,100
221107	B) 25x5,6 cm / plastová	1	0,100

Pasca proti holubom

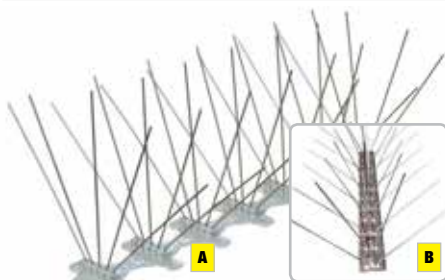

kód	popis	ks	kg
2170898	A) 40 hrotov / L-32 cm	1	0,072
2170901	A) 45 hrotov / L-60 cm	1	0,072
2170900	B) 48 hrotov / L-50 cm	1	0,102

Pasca na myši



kód	popis	ks	kg
221203	09x5 cm / 2ks	12	0,094
221207	14x7 cm / 1ks	24	0,137

Pasca na myši a potkany

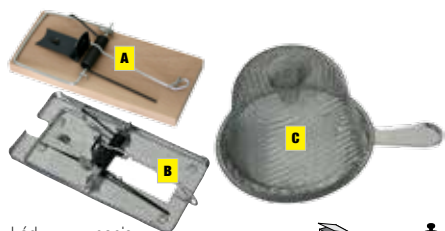

kód	popis	ks	kg
221256	A) drevená na myši	1	0,032
221115	A) drevená na myši / 2ks.	50	0,065
221200	B) na myši	1	0,030
221209	B) na potkany 160x90x0,6 mm	1	0,056
221753	B) na myši, 120x65x0,5 mm	1	0,113
221480	C) domčeková na myši	1	0,090

Detský nafukovací bazén



kód	popis		
8050050	Ø 147x147 cm výška so strieškou 122 cm objem v litroch 265	1	3,400

Steny sú vyrobené z veľmi pevného a súčasne tenkého vinylu, ktorý sa vyznačuje odolnosťou a dlhou životnosťou. Vďaka veľkému priemeru bazénika je určený aj pre viac osôb súčasne. Bazén môžete zatieniť s odnímateľnou nafukovacou strieškou - prichýtané na suchý zips, ktorá je súčasťou balenia.

Detský nafukovací kruhový bazén



kód	popis		
8050019	Ø 152 cm výška 30 cm objem v litroch 282	1	1,300

Bazén má tri, samostatne nafukovacie komory s bezpečnostnými ventilmi. Steny sú vyrobené z veľmi pevného a súčasne tenkého vinylu, ktorý sa vyznačuje odolnosťou a dlhou životnosťou. Vďaka veľkému priemeru bazénika je určený aj pre viac osôb súčasne.

Detský nafukovací kruhový bazén



kód	popis		
8050020	Ø 152 cm výška 30 cm objem v litroch 282	1	1,300

Bazén má tri, samostatne nafukovacie komory s bezpečnostnými ventilmi. Steny sú vyrobené z veľmi pevného a súčasne tenkého vinylu, ktorý sa vyznačuje odolnosťou a dlhou životnosťou. Vďaka veľkému priemeru bazénika je určený aj pre viac osôb súčasne.

Detský nafukovací kruhový bazén



kód	popis		
8050049	Ø 157 cm výška 46 cm objem v litroch 522	1	1,600

Bazén má štyri, samostatne nafukovacie komory s bezpečnostnými ventilmi. Steny sú vyrobené z veľmi pevného a súčasne tenkého vinylu, ktorý sa vyznačuje odolnosťou a dlhou životnosťou. Vďaka veľkému priemeru bazénika je určený aj pre viac osôb súčasne.

Detský nafukovací oválny bazén



kód	popis		
8050073	262x175 cm výška 51 cm objem v litroch 778	1	5,000

Bazén má dva, samostatne nafukovacie komory s bezpečnostnými ventilmi. Steny sú vyrobené z veľmi pevného a súčasne tenkého vinylu, ktorý sa vyznačuje odolnosťou a dlhou životnosťou. Vďaka veľkému priemeru bazénika je určený aj pre viac osôb súčasne.

Detský nafukovací oválny bazén



kód	popis		
8050051	262x175 cm výška 51 cm objem v litroch 778	1	5,000

Bazén má dva, samostatne nafukovacie komory s bezpečnostnými ventilmi. Steny sú vyrobené z veľmi pevného a súčasne tenkého vinylu, ktorý sa vyznačuje odolnosťou a dlhou životnosťou. Vďaka veľkému priemeru bazénika je určený aj pre viac osôb súčasne.

Detský nafukovací bazén



kód	popis		
8050074	Ø 99x91 cm výška so strieškou 71 cm objem v litroch 26	1	

Možnosť použitia na záhrade, pieskovisku, terase či balkóne. Nafukovacia strieška chráni deti proti priamemu slnku. Steny sú vyrobené z veľmi pevného, a súčasne tenkého vinylu, ktorý sa vyznačuje odolnosťou a dlhou životnosťou.

Nafukovací kruhový bazén bez filtrácie



kód	popis		
8050005	Ø 244 cm / výška 66 cm objem v litroch 2300	1	6,500
8050006	Ø 305 cm / výška 76 cm objem v litroch 3638	1	9,200
8050054	Ø 366 cm / výška 76 cm objem v litroch 5377	1	15,000

Samonosné kruhové rodinné bazény z pevného trojvrstvého vinylu patria vďaka svojej jednoduchej a rýchlej montáži medzi najpredávanejšie na trhu. Stačí nafúknuť horný prstenec, napustiť vodou a stúpajúci stĺp vody bazén sám postaví. Pružná konštrukcia rodinného bazéna je odolná voči mechanickému poškodeniu a zároveň vhodná a bezpečná pre deti.

Nafukovací kruhový bazén s filtráciou a rebríkom



kód	popis		
8050009	Ø 366 cm / výška 91 cm objem v litroch 6665 filtrácia cirkulačná 2006 l/hod schodíky do bazénu	1	29,300
8050010	Ø 457 cm / výška 91 cm objem v litroch 10179 filtrácia cirkulačná 2006 l/hod schodíky do bazénu	1	35,800

Samonosné kruhové rodinné bazény z pevného trojvrstvého vinylu patria vďaka svojej jednoduchej a rýchlej montáži medzi najpredávanejšie na trhu. Stačí nafúknuť horný prstenec, napustiť vodou a stúpajúci stĺp vody bazén sám postaví. Pružná konštrukcia rodinného bazéna je odolná voči mechanickému poškodeniu a zároveň vhodná a bezpečná pre deti.

Nafukovací kruhový bazén s filtráciou



kód	popis		
8050053	Ø 244 cm / výška 66 cm objem v litroch 2300 filtrácia cirkulačná 1249 l/hod	1	8,000
8050007	Ø 305 cm / výška 76 cm objem v litroch 3638 filtrácia cirkulačná 1249 l/hod	1	12,300
8050008	Ø 366 cm / výška 76 cm objem v litroch 5377 filtrácia cirkulačná 1249 l/hod	1	16,800

Samonosné kruhové rodinné bazény z pevného trojvrstvého vinylu patria vďaka svojej jednoduchej a rýchlej montáži medzi najpredávanejšie na trhu. Stačí nafúknuť horný prstenec, napustiť vodou a stúpajúci stĺp vody bazén sám postaví. Pružná konštrukcia rodinného bazéna je odolná voči mechanickému poškodeniu a zároveň vhodná a bezpečná pre deti.

Bazén kruhový s konštrukciou 360x90 cm + filtrácia



kód	popis		
8050001	Ø 360 cm výška 90 cm objem v litroch 8648 filtrácia cirkulačná 2006 l/hod schodíky do bazénu	1	71,800

Bazén má kovové steny odolné voči dažďom a atmosférickým vplyvom takže ho môžete mať celý rok. Vnútro pokrýva kvalitné silné trojvrstvé PVC. Montáž je úplne jednoduchá a nevyžaduje žiadne náradie. V balení dodávame DVD s video-návodom na montáž. Súčasťou balenia je aj bezpečný rebrík s protišmykovými schodíkmi. Kartušová filtrácia Flowclear pomáha vyčistiť bazén od plávajúcich nečistôt. Filter (typ II) pri miernom znečistení stačí opláchnuť pod tečúcou vodou. Pri silnom znečistení je potrebné vymeniť filter za nový (4 - 6 filtrov za sezónu).

Bazén kruhový s konštrukciou 366x100 cm + filtrácia



kód	popis		
8050003	Ø 366 cm výška 100 cm objem v litroch 9150 filtrácia cirkulačná 2006 l/hod schodíky do bazénu	1	43,000

Nadzemný bazén pre povrchovú montáž je vyrobený z trojvrstvého PVC a má pevné dno. Stačí len poskladať kovovú konštrukciu a napustiť vodu. Vďaka pružnej konštrukcii je bazén vhodný pre rodiny s deťmi.

Bazén kruhový s konštrukciou 427x84 cm + filtrácia



kód	popis		
8050001	Ø 427 cm výška 84 cm objem v litroch 10 220 filtrácia cirkulačná 2006 l/hod	1	36,900

Nadzemný bazén pre povrchovú montáž je vyrobený z trojvrstvého PVC a má pevné dno. Stačí len poskladať kovovú konštrukciu a napustiť vodu. Vďaka pružnej konštrukcii je bazén vhodný pre rodiny s deťmi.

Bazén kruhový s konštrukciou 366x76 cm + filtrácia



NOVINKA

kód	popis		
8050076	Ø 366 cm / výška 76 cm objem v litroch 6473 filtrácia cirkulačná 1249 l/hod	1	23,600

Nadzemný bazén pre povrchovú montáž je vyrobený z trojvrstvého PVC a má pevné dno. Stačí len poskladať kovovú konštrukciu a napustiť vodu. Vďaka pružnej konštrukcii je bazén vhodný pre rodiny s deťmi.

Bazén kruhový s konštrukciou 457x107 cm + filtrácia



NOVINKA

kód	popis		
8050077	Ø 457 cm / výška 107 cm objem v litroch 14 970 filtrácia cirkulačná 3028 l/hod schodíky do bazénu	1	58,500

Nadzemný bazén pre povrchovú montáž je vyrobený z trojvrstvého PVC a má pevné dno. Stačí len poskladať kovovú konštrukciu a napustiť vodu. Vďaka pružnej konštrukcii je bazén vhodný pre rodiny s deťmi.

Bazén kruhový s konštrukciou 305x76 cm + filtrácia



kód	popis		
8050001	Ø 305 cm výška 76 cm objem v litroch 4678 filtrácia cirkulačná 1249 l/hod	1	20,400

Nadzemný bazén pre povrchovú montáž je vyrobený z trojvrstvého PVC a má pevné dno. Stačí len poskladať kovovú konštrukciu a napustiť vodu. Vďaka pružnej konštrukcii je bazén vhodný pre rodiny s deťmi.

Ďetský nafukovací kruhový bazén



NOVINKA

kód	popis		
8050088	Ø 152 cm výška 30 cm objem v litroch 282	1	1,300

Bazén má tri, samostatne nafukovacie komory s bezpečnostnými ventilmi. Steny sú vyrobené z veľmi pevného a súčasne tenkého vinylu, ktorý sa vyznačuje odolnosťou a dlhou životnosťou. Vďaka veľkému priemeru bazénika je určený aj pre viac osôb súčasne.

Vírivka Palm Springs



NOVINKA

kód	popis		
8050038	Ø 196 cm / výška 71 cm	1	

Objem vody: 963 lit.
Ohrev vody: 2,05 kW
Rýchlosť ohrevu: 1,0 - 2,0 °C / hodina
Max. teplota vody: 40 °C

- ovládanie so vstavaným kontrolným panelom

Nafukovací vírivý bazén s elektrickým ohrevom vody a filtráciou je ideálny pre romantické chvíle, masáže a relaxačné účely, netradičné oslavy a neformálne stretnutia.

Je skonštruovaný pre celoročné použitie.

Hlavná ovládacia jednotka zaisťuje všetky prevádzkové funkcie vírivého bazéna a to výkonnou kartušovou filtráciou, prietokový digitálne nastaviteľný ohrev až do 40 °C, vzduchový kompresor pre nafúknutie a následné zásobovanie masážnych vzduchových trysiek.

Vhodné sú pre umiestnenie na záhradu, či terasu.

Model vírivkej vane Palm Springs je optimálnym riešením pohodlnej relaxácie pre 4 - 6 osôb.

Vírivka Paris



NOVINKA

kód	popis		
8050075	Ø 196 cm / výška 66 cm	1	

Objem vody: 806 lit.
Ohrev vody: 2,05 kW
Rýchlosť ohrevu: 1,5 - 2,0 °C / hodina
Max. teplota vody 40 °C

- ovládanie so vstavaným kontrolným panelom

LED osvetlenie diaľkové ovládanie

Nafukovací vírivý bazén s elektrickým ohrevom vody a filtráciou je ideálny pre romantické chvíle, masáže a relaxačné účely, netradičné oslavy a neformálne stretnutia.

Je skonštruovaný pre celoročné použitie.

Hlavná ovládacia jednotka zaisťuje všetky prevádzkové funkcie vírivého bazéna a to výkonnou kartušovou filtráciou, prietokový digitálne nastaviteľný ohrev až do 40 °C, vzduchový kompresor pre nafúknutie a následné zásobovanie masážnych vzduchových trysiek.

Vhodné sú pre umiestnenie na záhradu, či terasu.

Model vírivkej vane Paris je optimálnym riešením pohodlnej relaxácie pre 4 - 6 osôb.

HOUSEHOLD

Nafukovací kruh



NOVINKY

kód	popis		
8050067	Ø 107 cm	1	

Nafukovacie ležadlo



NOVINKA

kód	popis		
8050092	188x130 cm	1	

Nafukovací jednorozec



NOVINKA

kód	popis		
8050099	220x195 cm	1	

Nafukovacia kačička



NOVINKA

kód	popis		
8050098	135x91 cm	1	

Plameniak



NOVINKA

kód	popis		
8050100	175x173 cm	1	

Detský nafukovací delfín



kód	popis		
8050045	157x89 cm / plastové držiaky	1	

Kempingová nafukovacia stolička



NOVINKA

kód	popis		
8050084	159x53x14 cm	1	

Dvojité 5v1 multifunkčná pohovka



NOVINKA

kód	popis		
8050087	188x152x64 cm	1	

Multifunkčné: dvojité pohovka, dvojité kreslo, ležadlo, dvojposteľ, dvojposteľ.
Obsahuje vzduchové čerpadlo.

Posteľ



NOVINKA

kód	popis		
8050080	203x152x46 cm	1	

Pohodlný semišový povrch, abudovaný vankúš, do interieru

Matrac



NOVINKA

kód	popis		
8050081	188x99x22 cm	1	
8050082	203x152x22 cm	1	

Vankúš k matracom



NOVINKY

kód	popis		
8050086	A) 42x26x10 cm	1	
8050085	B) 42x26x10 cm	1	

Plavecké okuliare



NOVINKA

kód	popis		
8050094	nastaviteľný silikónový popruh na hlavu	1	

Plavecké okuliare



NOVINKA

kód	popis		
8050093	Farebné polykarbonátové šošovky so 100% UV ochranou. Nastaviteľný silikónový popruh na hlavu.	1	

Potapačský set



NOVINKA

kód	popis		
8050095	Mäkký, tvarovaný náustok trubičky. Technológia potápania so suchou vrchnou vrstvou bráni preniknutiu vody.	1	

Potápačsky set s plutvami



NOVINKA

kód	popis		
8050096	Mäkký, tvarovaný náustok trubičky. Úplne nastaviteľný popruh na hlavu. Dvojité obruba s mäkkým lemom na zabránenie netesnosti. Mäkké plutvy s nastaviteľným päťovým páskom.	1	

DOMÁCNOSŤ

Koleso nafukovacie Spider-Man



kód	popis		
8050036	Ø 56 cm	1	

Koleso nafukovacie Swim Ring



kód	popis		
8050043	Ø 56 cm	1	

Koleso nafukovacie Splash&Play



kód	popis		
8050039	Ø 69 cm / 4x vzduchový ventil	1	

Koleso nafukovacie High Velocity Tire



kód	popis		
8050044	Ø 119 cm / plastové rúčky	1	

Koleso nafukovacie, leňoška



kód	popis		
8050047	Ø 119 cm / 2x plastové rúčky 2x otvor na nápoje / sieťkové dno	1	

Nafukovacie rukavničky Spider-Man



kód	popis		
8050034	25x15 cm	1	

Nafukovacie rukavničky Swim



kód	popis		
8050040	25x15 cm	1	

Detský nafukovací čln Kiddie Car



kód	popis		
8050042	98x66 cm	1	

Detský nafukovací čln Spider-Man



kód	popis		
8050021	112x71 cm	1	0,500

Lopta nafukovacia Spider-Man



kód	popis		
8050035	Ø 51 cm	1	

Lopta nafukovacia



kód	popis		
8050041	Ø 51 cm	1	

Plávajúci bar do bazénu



kód	popis		
8050019	Ø 70 cm obsah v litroch 16	1	

Skvelá zábava a osvieženie do bazéna. 6x otvor na plechovky (24 plechoviek s obsahom 0,3 l + rad). Vychutnajte si osviežujúci nápoj aj keď ste vo vode.

Nafukovacia bránka na vodné polo s loptou 137x66 cm



kód	popis		
8050090	137x66 cm	1	

Nafukovacia bránka na vodné polo ponúka veľa zábavy nie len pre deti, ale aj pre dospelých! Bránka je vyrobená z testovaného vinylu, sieť je nylonová. Súčasťou výrobku je jedna lopta.

Nafukovací hrad



kód	popis		
8050091	175x135 cm	1	

Lopta nafukovacia



kód	popis		
8050097	Ø 41 cm	1	

NOVINKY

Nafukovačka do vody s vankúšom

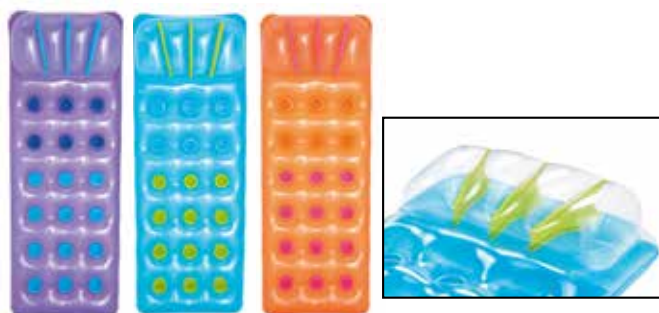

kód	popis		
8050046	188x71 cm / mix farieb	1	

Nafukovačka do vody



kód	popis		
8050030	188x71 cm / mix farieb	1	

Nafukovačka do vody



kód	popis		
8050032	183x69 cm / mix farieb	1	

Kartušová filtrácia a náhradné kartidže

Kartušová filtrácia zaisťujú čistú vodu vo vašom bazéne. Určená je hlavne k nafukovacím bazénom. Je možné ju použiť aj k nadzemným bazénom. Filtrácia obsahuje 1 kus filtračnej vložky. Nádoba odolná voči korózii. Maximálna teplota vody 35°. Čistiteľný a výmenný filter.



kód	popis		
Filtrácia 8050022	Príkon 25 W Napätie 220-240 V Filtračný výkon 1249 l/hod	I	1
Filtrácia 8050023	Príkon 45 W Napätie 220-240 V Filtračný výkon 2006 l/hod	II	1
Kartidž 8050014	I) Ø8,0 x H9,0 cm Náhradný kartidž pre kartušové filtrácie 1249 l/hod	I	6 1,000
Kartidž 8050015	II) Ø10,6 x H13,6 cm Náhradný kartidž pre kartušové filtrácie 2006 l/hod	II	6 1,700
Kartidž 8050066	VI) Ø5,1 x H10,5 cm Náhradný kartidž	VI	6 1,700

Osviežovač vzduchu STARMIST

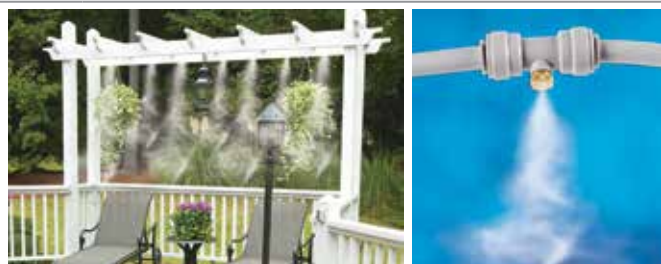

kód	popis		
217616	dosah 06 m, 3/8"	1	
217780	dosah 12 m, 3/8"	1	

Sada na inštaláciu rozprašovača s dýzami pre osvieženie v letných mesiacoch. Z dýz vychádza príjemná osviežujúca hmla, ktorej výhodou je, že nezanecháva mokré prostredie.

Piesková filtrácia



kód	popis		
8050016	A) Príkon 90 W Napätie 220-240 V Šesťcestný regulačný ventil Filtračný výkon 2006 l/hod Nádoba odolná voči korózii Maximálna teplota vody 35° C Potrebné množstvo piesku cca 8,5 kg (kremičitý piesok, hrúbosť zrn 0,45 - 0,85 mm) Priemer 27,4 cm	1	8,700
8050017	B) Príkon 200 W Napätie 220-240 V Šesťcestný regulačný ventil Nádoba odolná voči korózii Filtračný výkon 3785 l/hod Maximálna teplota vody 35° C Potrebné množstvo piesku 18 kg (kremičitý piesok, hrúbosť zrn 0,5 - 1,25 mm)	1	12,000
8050068	B) Príkon 280 W Napätie 220-240 V Šesťcestný regulačný ventil Nádoba odolná voči korózii Filtračný výkon 7571 l/hod Maximálna teplota vody 35° C Potrebné množstvo piesku 35 kg (kremičitý piesok, hrúbosť zrn 0,5 - 1,25 mm)	1	16,450
8050037	Piesok do pieskovej filtrácie, bal. 25 kg, zrnitosť 0,8-1,2 mm	1	

Výkonná piesková filtrácia používa na separovanie nečistôt kremičitý piesok, ktorý kladie pretekajúcej vode z bazéna prirodzený odpor a zachytáva tak v medzerách väčšinu nečistôt. Vyčistená voda sa potom opäť vracia späť do bazéna. Piesková filtrácia a jej princíp sa používa i pri čistení pitných vôd, pretože jednoduché a lacné čistenie resp. výmena pieskovej náplne výrazne znižuje prevádzkové náklady. Pieskovú filtráciu dodávame s príslušenstvom (hadice na pripojenie k bazénu 32 mm). Použitím účinnej filtrácie bazéna sa výrazne znižuje spotreba prostriedkov bazénovej chémie.

DOMÁCNOSŤ

Plachta zakrývacia, bazénová



kód	popis		
8050026	Ø 244 cm	4	3,500
8050024	Ø 305 cm	2	2,500
8050025	Ø 366 cm	1	2,300
8050058	Ø 457 cm	1	

Chrání Váš bazén pred nečistotami a pomáha udržiavať teplotu vody v bazéne.

Plachta solárna, bazénová



kód	popis		
8050011	Ø 305 cm	4	3,500
8050012	Ø 366 cm	2	2,500
8050013	Ø 457 cm	1	2,300

ohrievanie bazénovej vody / zabráni odparu vody a chemických prostriedkov
zabráni úniku tepla z bazénu pri chladných dňoch a v noci čiastočne zachytí nečistoty ako je listie, nečistoty z ovzdušia atď.

Plachta zakrývacia, bazénová



kód	popis		
8050059	Ø 305 cm	1	
8050060	Ø 360 cm	1	

Chrání Váš bazén pred nečistotami a pomáha udržiavať teplotu vody v bazéne.

Plachta solárna, bazénová



kód	popis		
8050061	Ø 305 cm	1	
8050062	Ø 366 cm	1	
8050063	Ø 457 cm	1	

ohrievanie bazénovej vody / zabráni odparu vody a chemických prostriedkov
zabráni úniku tepla z bazénu pri chladných dňoch a v noci čiastočne zachytí nečistoty ako je listie, nečistoty z ovzdušia atď.

Plachta zakrývacia, bazénová



kód	popis		
8050078	262x175x51 cm	1	

Chrání Váš bazén pred nečistotami a pomáha udržiavať teplotu vody v bazéne.

Podložka pod bazén



kód	popis		
8050057	50x50 cm / bal. 8ks	1	

Nalepovacia opravná fólia



kód	popis		
8050072	65x65 mm / bal. 10ks	1	

10 ks opravných samonalepovacích fólií pre namáhané spoje - bazény, nafukovačky, člny. Pre lepenie pod vodou. Po nalepení treba 30 minút počkať pre dokonalé zalepenie

Súprava bazénová na opravu



kód	popis		
2170173	30 ml, oprava na Vinyl	1	

Vanička na nohy



kód	popis		
8050079	Menovitá kapacita vody: 9 lit.	1	

Jednoducho sa pripe na rebrik na opláchnutie nôh pred vstupom do bazéna. Podlaha s ochranou proti pošmyknutiu pre vyššiu bezpečnosť. Kompatibilný s väčšinou rebrikov nadzemných bazénov.

Pumpa elektrická



kód	popis		
8050071	Napätie 220-240 V	1	

Výkon je dostatočný pre nafukovanie väčších výrobkov - rekreačných člnov do 3 m dĺžky, rodinných lehátok, záhradných bazénov, nafukovacích lôžok atď.

Pumpa ručná



kód	popis		
8050069	Ø 37 cm	1	

Služi na nafukovanie člnov, bazénov, ležadiel a podobných výrobkov. Nemožno ju používať napr. na futbalové lopty, duši kolies a podobne

Pumpa nožná



kód	popis		
8050070	Ø 13 cm	1	

Pre nafukovanie menších výrobkov - rukavičky, lopty, bazéniky...

Pumpa nožná

NOVINKA



kód	popis		
8050083	28 x 19 cm objem 1,4 l	1	

Pumpa s ohybnou hadicou a troma adaptérami, vyrobená z odolného plastu na nafukovanie lehátok, člnov, kruhov, atď.

Tester digitálny



kód	popis		
2170292	pH/CL	40	0,240

Dávkovač na tablety



kód	popis		
2170166	3" tablety	12	0,330

Dávkovač na tablety s teplomerom



kód	popis		
2170289	3" tablety	24	0,330

Bazénový vysávač Clear



kód	popis		
8050029	4-dielna tyč (224 cm)	1	
2 adaptéry / Znovopoužiteľné vrečko na nečistoty			
2 trysky (jedna s kefkou) / 6 m hadica (priem. 32 mm)			

Schodky k bazénom



kód	popis		
8050027	A) 76 cm, 2 stupienky, max. 150kg	1	
8050064	A) 84 cm, 2 stupienky, max. 150kg	1	
8050028	A) 91 cm, 3 stupienky, max. 150kg	1	
8050065	B) 107 cm, 3 stupienky, max. 150kg	1	

Hlava vysávača



kód	popis		
2170287	Triangel	6	1,620

Hlava vysávača



kód	popis		
2170286	DeLuxe Triangel	6	1,500

Hadica



kód	popis		
2170288	1-1/2", PE, L-7m	4	1,650

Automatický čistič



kód	popis		
2170290	jednoduchá inštalácia	2	6,000

Kartač na tyč



kód	popis		
2170172	450 mm	12	0,383

Tyč teleskopická



kód	popis		
2170291	120/360 cm, 0,8 mm	20	0,870
2170167	120/360 cm, 1,1 mm	20	0,750

Huba na bazén

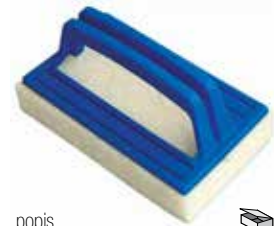

kód	popis		
2170573	145x85x25 mm	1	

Keňa na bazén



kód	popis		
2170572	140 mm	1	

Sieťka povrchová na lístie a špinu



kód	popis		
2170285	HD, EZclip, bez tyče	12	0,380

Sieťka hĺbková na špinu



kód	popis		
2170284	HD, EZclip, bez tyče	12	0,450

Sieťka povrchová na lístie a špinu



kód	popis		
2170293	teleskopická tyč	24	0,460

Int. kód	diel č.	Výška 1.5m	začiatkový	priebežný
			počet KS	počet KS
2210883	H11	Celo H11 1250 mm	1	1
2210877	H01	Nosník H01 1509x80x30x2.5 mm	2	1
2210888	H04	Panel H04 plný 1250x200x0.6 mm	1	1
2210886	H05	Panel H05 plný 1250x400x0.6 mm	3	3
2210880	H07	Patka H07 470 mm	2	1
2210882	H08	Polica H08 Base 1250x470x0.8 mm, základňa	1	1

Panel 1500 mm x 1250 x 500 (VxŠxH) JEDNOSTRANNY

Int. kód	diel č.	Výška 2.0m	začiatkový	priebežný
			počet KS	počet KS
2210883	H11	Celo H11 1250 mm	1	1
2210879	H02	Nosník H02 2009x80x30x2.5 mm	2	1
2210886	H05	Panel H05 plný 1250x400x0.6 mm	4	4
2210887	H06	Panel H06 plný 1250x300x0.6 mm	1	1
2210880	H07	Patka H07 470 mm	2	1
2210882	H08	Polica H08 Base 1250x470x0.8 mm, základňa	1	1

Panel 2000 mm x 1250 x 500 (VxŠxH) JEDNOSTRANNY

Int. kód	diel č.	Výška 2.4m	začiatkový	priebežný
			počet KS	počet KS
2210883	H11	Celo H11 1250 mm	1	1
2210928	H24	Nosník H24 2409x80x30x2.5 mm	2	1
2210886	H05	Panel H05 plný 1250x400x0.6 mm	5	5
2210887	H06	Panel H06 plný 1250x300x0.6 mm	1	1
2210880	H07	Patka H07 470 mm	2	1
2210882	H08	Polica H08 Base 1250x470x0.8 mm, základňa	1	1

Panel 2400 mm x 1250 x 500 (VxŠxH) JEDNOSTRANNY

Int. kód	diel č.	NOVINKA – Šírka 1m	jedn.
			KS
2212053	006	Konzola Raquacraft 006	KS
2212048	001	Nosník Raquacraft 001, 30x80x2109x2.5 mm	KS
2212051	004	Panel Raquacraft 004, 950x400x1.2 mm	KS
2212052	005	Panel Raquacraft 005, 950x400x0.6 mm	KS
2212049	002	Patka Raquacraft 002, D470 mm	KS
2212054	007	Vesiak Raquacraft 007, M06, L-200 mm	KS
2212050	003	Zakladna Raquacraft 003, 950x470x0.8 mm	KS

Int. kód	diel č.	Príslušenstvo	jedn.
			KS
2210885	H13	Kos H13 1250x400x350 mm, drôtený	KS
2210891	H15	Kos H15 1000x500x360 mm, drôtený	KS
2210884	H12	Lista Racks H12 na cenovky (zelená)	KS
2210981	H29	Lista Racks H29 na cenovky (červená)	KS
2210395	H14	Polica 1200x0250x0400mm, drôtená na konzoly	KS
2210889	H09	Polica Racks H09 1250x470x0.8 mm	KS
2210890	H10	Polica Racks H10 1250x370x0.8 mm	KS
2210941	H26	Polica Racks H26 1250x370x0.8 mm, základňa	KS
2210384	H16	Vesiak Racks H16 G 0300 mm	KS
2210387	H17	Vesiak Racks H17 0300 mm s PVC cenovkou	KS
2210942	H18	Vesiak Racks H18 0150 mm, M06	KS
2210945	H22	Vesiak Racks H22 0500x25x25x1.2 mm	KS
2210946	H23	Vesiak Racks H23 0400 mm, M08	KS
2210943	H19	Klietka Racks H19 1200x100x0900 mm	KS
2210947		Konzola Racks	KS
2210881	H03	Panel H03 perforovaný 1250x400x1.0 mm	KS
2210940	H25	Patka H25 370 mm	KS
2210944	H20	Ťýč Racks H20 1250x20x40x1.5 mm	KS
2211005	H31	Prepažka Racks H31 470x200 mm, Cr, bočná	KS
2211004	H30	Prepažka Racks H30 1250x100 mm, Cr, predná	KS
2210948	H28	Kryt H28, na panely – vrchná čiapka	KS

Regálový systém pre maloobchodné predajne



Polica nastaviteľná v rôznych uhloch.

Regál je možné zostaviť aj obojstranne.

Nosnosť police je 80kg.

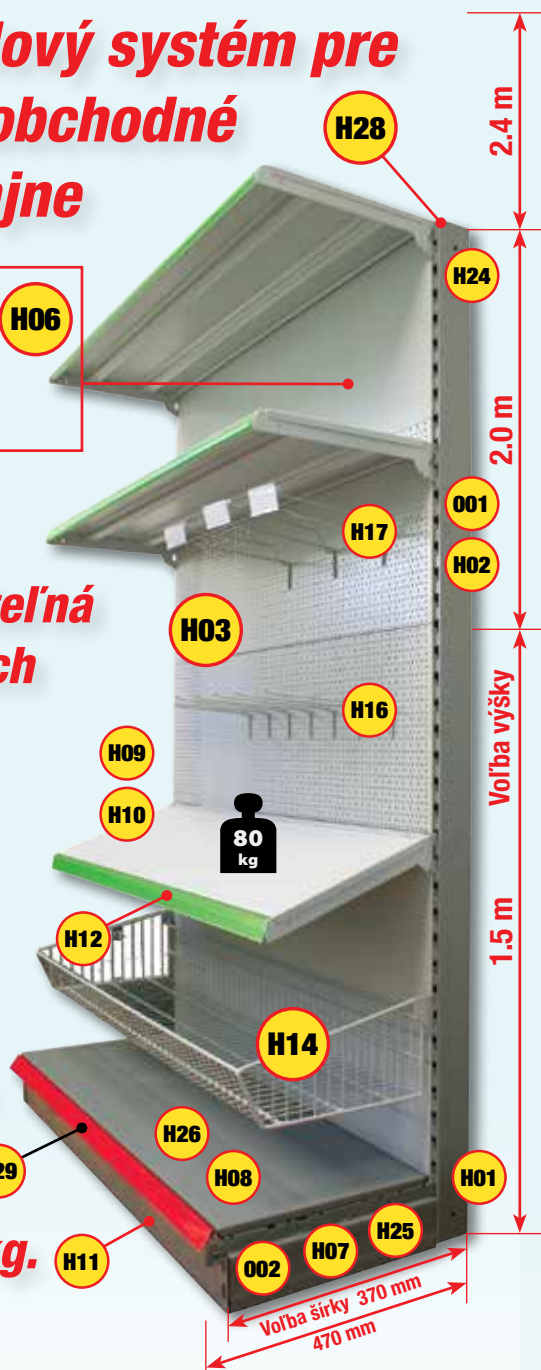

Nákupný košík PVC
254496 20 lit.



Na policu je možné poskladať bočnú (H31) a zároveň prednú (H30) prepažku pre organizovanie tovaru na policiach.

