

YATO ®

2018



1 SPANNERS / KLUCZE 4-19



2 SOCKETS, ACCESSORIES & SETS / KLUCZE NASADOWE, AKCESORIA I ZESTAWY 20-57



3 IMPACT SOCKETS, ACCESSORIES & SETS / UDAROWE KLUCZE NASADOWE, AKCESORIA I ZESTAWY 58-65



4 TORQUE WRENCHES & TORQUE MULTIPLIERS / KLUCZE DYNAMOMETRYCZNE I WZMACNIACZE MOMENTU 66-71



5 SCREWDRIVERS & SCREWDRIER BITS / WKREŹTAKI I KOŃCÓWKI WKREŹTAKOWE 72-91



6 PLIERS & PIPE WRENCHES / SZCZYPCE I KLUCZE DO RUR 92-107



7 ELECTRICIAN TOOLS / NARZĘDZIA DLA ELEKTRYKÓW 108-127

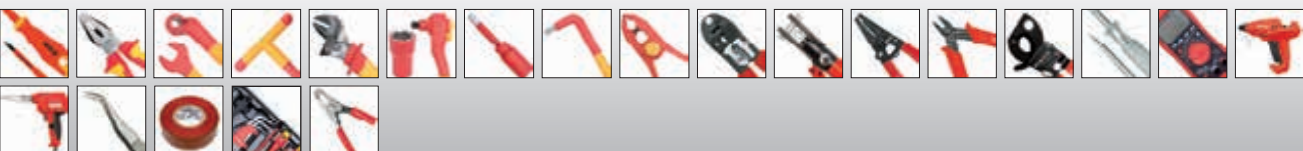

8 HAMMERS, CHISELS, PUNCHES & AXES / MŁOTKI, DŁUTA, PRZECINAKI I SIEKIERY 128-137



9 CLAMPS, VICES & HOLDERS / ŚCISKI, IMADŁA I WSPORNIKI 138-143



10 CUTTING TOOLS / NARZĘDZIA TNĄCE 144-195



11 HYDRAULIC TOOLS / NARZĘDZIA HYDRAULICZNE 196-209



12	FASTENING TOOLS / NARZĘDZIA DO ŁĄCZENIA	210-221
13	CONSTRUCTION TOOLS / NARZĘDZIA BUDOWLANE	222-239
14	MEASURING TOOLS / NARZĘDZIA MIERNICZE	240-249
15	PNEUMATIC TOOLS / NARZĘDZIA PNEUMATYCZNE	250-265
16	SPECIAL AUTOMOTIVE TOOLS & EQUIPMENT / NARZĘDZIA I WYPOSAŻENIE WARSZTATU SAMOCHODOWEGO	266-367
17	WELDING EQUIPMENT & ACCESSORIES / NARZĘDZIA SPAWALNICZE I AKCESORIA	368-379
18	POWER & GASOLINE TOOLS / ELEKTRONARZĘDZIA I NARZĘDZIA SPALINOWE	380-415
19	ACCESSORIES / AKCESORIA	416-421
20	HEALTH & SAFETY ARTICLES / ARTYKUŁY BHP	422-435
21	ELECTRIC PRODUCTS / ARTYKUŁY ELEKTRYCZNE	436-451
22	GARDEN TOOLS / NARZĘDZIA OGRODNICZE	452-479

1

Spanners Klucze



Combination spanners
Klucze płasko-oczkowe

6-8

Half-moon spanners
Klucze oczkowe typu „C”

14



Combination spanners & sets, polished head

Klucze płasko-oczkowe i zestawy, polerowana główka

6

Combination spanners & sets, satin finish

Klucze płasko-oczkowe i zestawy, wykończenie satynowe

7

Combination spanners S.A.E., polished head

Klucze płasko-oczkowe S.A.E., polerowana główka

8

Stubby combination spanners, polished head

Klucze płasko-oczkowe krótkie, polerowana główka

8

Flare nut wrenches & sets

Klucze oczkowe półotwarte i zestawy

14



Flexible flare nut wrench sets

Zestawy kluczy oczkowych półotwartych z przegubem

14



Combination ratchet wrenches

Klucze płasko-oczkowe z grzechotką

8-9



Torx ring spanner sets

Zestawy kluczy oczkowych „Torx”

15



Combination ratchet wrenches & sets

Klucze płasko-oczkowe z grzechotką i zestawy

8

Flexible ratchet combination wrenches

Klucze płasko-oczkowe z grzechotką i przegubem

9

L-type socket wrenches

Klucze nasadowe typu „L”

15



Double open end spanners

Klucze płaskie

10



Tubular socket wrenches & accessories

Klucze rurowe kute i akcesoria

15



Double open end spanners & sets, polished head

Klucze płaskie i zestawy, polerowana główka

10

Double open end spanners & sets, satin finish

Klucze płaskie i zestawy, wykończenie satynowe

10

Double ratchet wrenches

Dwustronne klucze nasadowe z grzechotką

15-16



Double ratchet spanner sets

Zestawy kluczy oczkowych z grzechotką

11



T-type socket wrenches

Klucze nasadowe typu „T”

16-17



Bi-hexagonal ring spanners

Klucze oczkowe odgięte

11-12



Socket wrenches with handle

Klucze nasadowe z rękojeścią

16

T-type deep socket wrenches with rotary handle

Klucze nasadowe typu „T” z obrotową rączką

16

T-type adapters with rotary handle

Adaptery typu „T” z obrotową rączką

16

Insulated T-handle wrenches

Rękojeści typu „T” z zabierakiem izolowane

17

T-type deep socket wrenches

Klucze nasadowe typu „T”

17

T-handle swivel socket wrenches

Klucze nasadowe typu „T” z przegubem

17

Insulated ring & open end wrenches

Klucze oczkowe i płaskie izolowane

12-13



Insulated ring wrenches

Klucze oczkowe izolowane

12

Insulated open end wrenches

Klucze płaskie izolowane

13

Adjustable wrenches

Klucze nastawne

18



Impact wrenches

Klucze do pobijania

13



Flexible hook wrenches

Klucze hakowe

18



Ring impact wrenches

Klucze oczkowe do pobijania

13

Open end impact wrenches

Klucze płaskie do pobijania

13

1

GB Combination spanner
D Maulringschlüssel
PL Klucz płasko-oczkowy
RUS Ключ комбинированный
CZ Plochý a očkový klíč
H Kulcs villás-csillag
RO Cheie combinată

F Clé mixte à cliquet
I Chiave combinata
E Combinada con llave de estrella
CN 两用扳手

DIN 3113 CrV AS-DRIVE

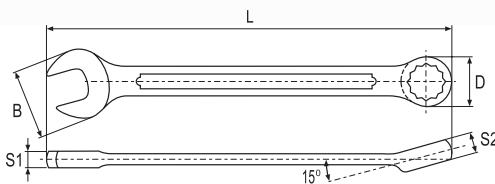

- application: workshop
- head offset: 15°
- surface finish: chromed, satin

- przeznaczenie: warsztat
- kąt odchylenia główek: 15°
- wykończenie powierzchni: chromowana, satynowa

COLOR BOX



YATO	Ø (mm)	L (mm)	B (mm)	D (mm)	S1 (mm)	S2 (mm)	PCS packing	Box
YT-0335	6	110	14.8	10.5	3.7	4.9	10	300/600
YT-0336	7	120	16.1	11.3	4.0	5.3	10	300/600
YT-0337	8	130	18.5	12.9	4.2	5.0	10	180/360
YT-0338	9	140	20.5	14.6	4.2	5.0	10	180/360
YT-0339	10	150	22.2	16.2	4.9	6.4	10	180/360
YT-0340	11	160	25.5	17.3	4.9	7.0	10	180/360
YT-0341	12	170	26.7	18.7	5.3	7.6	10	120/240
YT-0342	13	180	28.0	19.6	5.5	8.2	10	120/240
YT-0343	14	190	30.3	21.4	5.9	7.7	10	50/100
YT-0344	15	200	32.8	22.8	6.2	8.5	10	50/100
YT-0345	16	210	33.9	23.7	6.1	9.1	10	50/100
YT-0346	17	220	35.9	24.7	6.5	9.1	10	50/100
YT-0347	18	230	37.8	26.9	6.9	10.0	10	50/100

YATO	Ø (mm)	L (mm)	B (mm)	D (mm)	S1 (mm)	S2 (mm)	PCS packing	Box
YT-0348	19	235	38.9	27.7	7.0	10.1	10	50/100
YT-0349	20	250	41.4	29.2	7.3	11.0	10	40/80
YT-0350	21	260	43.4	31.0	7.1	10.9	10	40/80
YT-0351	22	270	45.9	32.2	8.1	11.2	5	20/40
YT-0352	23	280	47.8	34.3	7.8	11.1	5	20/40
YT-0353	24	290	49.9	34.8	9.2	11.2	5	20/40
YT-0354	25	300	51.2	36.6	9.2	12.4	5	20/40
YT-0355	26	310	53.2	37.4	9.2	12.9	5	20/40
YT-0356	27	320	55.9	39.3	9.3	12.7	5	15/30
YT-0357	28	330	56.5	40.9	9.9	13.5	5	15/30
YT-0358	29	340	60.0	42.4	10.0	13.6	5	15/30
YT-0359	30	350	60.9	43.8	10.0	14.7	5	10/20
YT-0360	32	370	64.5	46.6	11.3	14.9	5	10/20

GB Combination spanner
D Maulringschlüssel
PL Klucz płasko-oczkowy
RUS Ключ комбинированный
CZ Plochý a očkový klíč
H Kulcs villás-csillag
RO Cheie combinată

F Clé mixte à cliquet
I Chiave combinata
E Combinada con llave de estrella
CN 两用扳手

AS-DRIVE

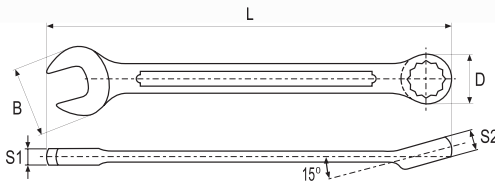

- application: workshop
- head offset: 15°
- surface finish: chromed, satin

- przeznaczenie: warsztat
- kąt odchylenia główek: 15°
- wykończenie powierzchni: chromowana, satynowa

COLOR BOX



YATO	Ø (mm)	L (mm)	B (mm)	D (mm)	S1 (mm)	S2 (mm)	PCS packing	Box
YT-00760	34	425	65.2	51.0	13.0	16.0	5	20
YT-00761	36	460	73.0	57.0	14.0	17.5	5	15
YT-00762	38	460	73.0	57.0	14.0	17.5	5	15
YT-00763	41	500	83.0	61.5	15.0	19.0	5	10
YT-00764	46	540	88.3	69.0	16.5	21.0	5	10

YATO	Ø (mm)	L (mm)	B (mm)	D (mm)	S1 (mm)	S2 (mm)	PCS packing	Box
YT-00765	48	570	92.0	72.0	16.5	22.0	5	10
YT-00766	50	598	96.0	74.0	18.0	23.5	2	8
YT-00767	55	620	105.6	82.4	19.0	25.0	2	6
YT-00768	60	660	115.2	89.8	21.0	27.0	2	6
YT-00769	65	680	124.8	97.3	23.0	29.0	2	4

GB Combination spanner set
D Maulringschlüsselsatz
PL Komplet kluczy płasko-oczkowych
RUS Набор ключей комбинированных

CZ Souprava plochých a očkových klíčů
H Kulcskészlet, villás-csillag
RO Set chei combinată
F Set de clés mixtes

I Set chiave combinata
E Juego de combinadas con llave de estrella
CN 两用扳手组套

POUCH & COLOR BOX



DIN 3113 CrV AS-DRIVE



12 PCS 8, 9, 10, 11, 12, 13, 14, 15, 17, 19, 22, 24 mm

17 PCS 8, 9, 10, 11, 12, 13, 14, 15, 16, 17, 18, 19, 22, 24, 27, 30, 32 mm

25 PCS 6, 7, 8, 9, 10, 11, 12, 13, 14, 15, 16, 17, 18, 19, 20, 21, 22, 23, 24, 25, 26, 27, 28, 30, 32 mm

YATO	Box	6
YT-0362		

YATO	Box	3
YT-0363		

YATO	Box	3
YT-0365		

- GB** Combination spanner
D Maulringschlüssel
PL Klucz płasko-oczkowy
RUS Ключ комбинированный
CZ Ploché a očkový klič
H Kulcs villás-csillag
RO Cheie combinată
- F** Clé mixte à cliquet
I Chiave combinata
E Combinada con llave de estrella
CN 两用扳手

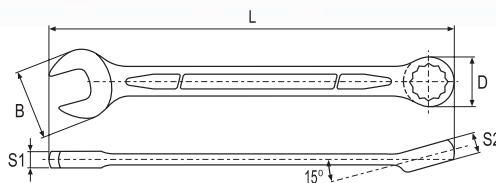

- application: industry
- head offset: 15°
- maximum torque exceeding DIN and ANSI standards by 60%
- surface finish: chromed, satin
- przeznaczenie: przemysł
- kąt odchylenia główki: 15°
- maksymalny moment obrotowy większy o 60% niż w standardach DIN i ANSI
- wykończenie powierzchni: chromowana, satynowa

COLOR BOX



YATO	Ø (mm)	L (mm)	B (mm)	D (mm)	S1 (mm)	S2 (mm)	PCS packing:	
YT-0006	6	109	14.4	10.3	3.7	5.2	10	600
YT-0007	7	119	16.2	11.3	3.8	5.2	10	600
YT-0008	8	129	18.6	12.8	4.2	5.7	10	360
YT-0009	9	139	20.7	14.1	4.3	6.4	10	360
YT-0010	10	149	22.6	15.2	4.8	6.9	10	360
YT-0011	11	159	24.6	16.8	5.2	7.4	10	360
YT-0012	12	169	27.1	18.0	5.3	7.9	10	240
YT-0013	13	179	28.7	19.8	6.0	8.6	10	240
YT-0014	14	189	31.3	20.8	6.2	8.9	10	100
YT-0015	15	199	33.2	22.3	6.6	9.2	10	100
YT-0016	16	209	35.0	23.8	6.8	9.9	10	100
YT-0017	17	219	37.5	25.0	7.0	10.9	10	100
YT-0018	18	229	39.5	26.6	7.8	11.4	10	100
YT-0019	19	239	41.3	28.0	8.0	12.1	10	100
YT-0020	20	249	44.1	29.8	8.3	12.4	10	80
YT-0021	21	259	46.1	30.8	8.6	12.7	10	80

YATO	Ø (mm)	L (mm)	B (mm)	D (mm)	S1 (mm)	S2 (mm)	PCS packing:	
YT-0022	22	269	48.2	32.2	9.0	13.1	5	40
YT-0023	23	279	49.8	33.6	9.2	13.4	5	40
YT-0024	24	289	51.4	34.3	9.6	13.4	5	40
YT-0025	25	299	54.6	36.8	9.8	14.2	5	40
YT-0026	26	309	56.2	37.3	10.0	14.9	5	40
YT-0027	27	319	58.7	39.6	10.4	16.4	5	30
YT-0028	28	329	59.4	40.7	10.8	16.9	5	30
YT-0030	30	349	63.0	43.3	11.3	18.4	5	30
YT-0032	32	369	67.3	44.8	11.8	19.4	4	24
YT-0036	36	435	74.0	53.5	13.8	19.5	-	5/10
YT-0038	38	445	76.0	55.0	16.3	20.3	-	5/10
YT-0041	41	475	83.7	61.6	16.3	20.3	-	2/8
YT-0046	46	545	99.0	75.3	19.5	22.7	-	2/8
YT-0050	50	545	99.5	76.0	19.5	22.7	-	2/8
YT-0055	55	610	110.0	80.0	19.5	22.7	-	2/4

- GB** Combination spanner set
D Maulringschlüsselsatz
PL Komplet kluczy płasko-oczkowych
RUS Набор ключей комбинированных
- CZ** Souprava plochéh a očkovýh kličů
H Kulcskészlet, villás-csillag
RO Set chei combinatē
F Set de clés mixtes
- I** Set chiave combinata
E Juego de combinadas con llave de estrella
CN 两用扳手组套

POUCH & COLOR BOX



10
PCS
6, 7, 8, 10, 12, 13,
14, 15, 17, 19 mm

YATO
YT-0060

20

12
PCS
8, 9, 10, 11, 12, 13, 14,
15, 17, 19, 22, 24 mm

YATO
YT-0062

6



15
PCS
6, 7, 8, 10, 11, 12, 13, 14, 15,
17, 18, 19, 22, 24, 27 mm

YATO
YT-0065

8

17
PCS
8, 9, 10, 11, 12, 13, 14, 15, 16, 17,
18, 19, 22, 24, 27, 30, 32 mm

YATO
YT-0067

3



25
PCS
6, 7, 8, 9, 10, 11, 12, 13, 14,
15, 16, 17, 18, 19, 20, 21, 22,
23, 24, 25, 26, 27, 28, 30, 32 mm

YATO
YT-0075

3

1

GB Combination spanner
D Maulringschlüssel
PL Klucz płasko-oczkowy
RUS Ключ комбинированный

CZ Plochý a očkový klíč
H Kulcs villás-csillag
RO Cheie combinată
F Clé mixte à cliquet

I Chiave combinata
E Combinada con llave de estrella
CN 两用扳手

S.A.E. DIN 3113 CrV AS-DRIVE

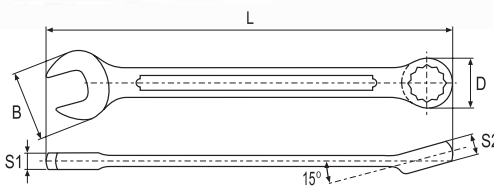

- application: workshop
- head offset: 15°
- surface finish: chromed, satin / mirror
- przeznaczenie: warsztat
- kąt odchylenia główek: 15°
- wykończenie powierzchni: chromowana, satynowa / polerowana

COLOR BOX



YATO	Ø	L (mm)	B (mm)	D (mm)	S1 (mm)	S2 (mm)	PCS packing:	
YT-4870	1/4" (6.3 mm)	110	13.9	10.7	4.0	4.9	10	300/600
YT-4871	5/16" (7.9 mm)	130	17.6	12.8	4.6	5.7	10	180/360
YT-4872	3/8" (9.5 mm)	150	21.5	15.5	4.8	6.1	10	180/360
YT-4873	7/16" (11.1 mm)	160	23.8	17.0	5.1	6.7	10	180/360
YT-4874	1/2" (12.7 mm)	180	27.6	19.9	5.6	8.0	10	120/240
YT-4875	9/16" (14.3 mm)	190	29.6	21.6	6.1	8.1	10	120/240
YT-4876	5/8" (15.9 mm)	210	33.6	23.9	6.3	9.2	10	50/100
YT-4877	11/16" (17.5 mm)	230	37.8	26.3	6.7	10.8	10	50/100

YATO	Ø	L (mm)	B (mm)	D (mm)	S1 (mm)	S2 (mm)	PCS packing:	
YT-4878	3/4" (19.0 mm)	240	40.1	27.9	7.2	10.6	10	50/100
YT-4879	13/16" (20.6 mm)	260	43.2	31.1	7.6	10.8	10	40/80
YT-4880	7/8" (22.2 mm)	270	46.5	32.9	8.4	11.6	5	20/40
YT-4881	15/16" (23.8 mm)	290	50.2	34.9	8.7	12.0	5	20/40
YT-4882	1" (25.4 mm)	300	51.9	36.2	8.8	12.7	5	20/40
YT-4883	1-1/16" (27.0 mm)	320	56.0	38.9	9.3	13.6	5	15/30
YT-4884	1-1/8" (28.6 mm)	340	59.7	42.2	9.8	14.2	5	15/30
YT-4885	1-1/4" (31.8 mm)	370	65.5	46.2	10.9	15.6	5	10/20

GB Stubby combination spanner
D Maulringschlüssel
PL Klucz płasko-oczkowy krótki
RUS Ключ комбинированный
CZ Plochý a očkový klíč
H Kulcs villás-csillag
RO Cheie combinată
F Clé mixte courte
I Chiave combinata corta
E Combinada con llave de estrella
CN 两用扳手

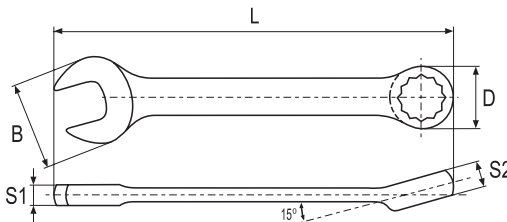

- application: workshop
- head offset: 15°
- surface finish: chromed
- przeznaczenie: warsztat
- kąt odchylenia główek: 15°
- wykończenie powierzchni: chromowana

CrV AS-DRIVE

COLOR BOX



YATO	Ø (mm)	L (mm)	B (mm)	D (mm)	S1 (mm)	S2 (mm)	PCS packing:	
YT-4901	8	91	19.2	13.9	5.0	6.3	10	120/240
YT-4902	9	97	21.7	16.4	5.4	6.4	10	120/240
YT-4903	10	97	21.9	16.6	5.2	6.4	10	120/240
YT-4904	11	100	23.2	18.3	5.9	7.2	10	120/240
YT-4905	12	108	27.4	20.2	6.4	7.6	10	120/240
YT-4906	13	109	27.9	20.7	6.7	7.7	10	120/240

YATO	Ø (mm)	L (mm)	B (mm)	D (mm)	S1 (mm)	S2 (mm)	PCS packing:	
YT-4907	14	115	29.3	22.1	6.1	8.3	10	60/120
YT-4908	15	120	31.2	24.0	6.8	9.6	10	60/120
YT-4909	16	121	32.0	24.3	6.8	9.6	10	60/120
YT-4910	17	128	36.6	27.1	7.4	9.9	10	60/120
YT-4911	18	127	36.2	26.8	7.4	9.9	10	60/120
YT-4912	19	135	39.2	29.5	8.8	10.8	10	60/120

GB Combination ratchet wrench
D Ratschenringmaulschlüssel
PL Klucz płasko-oczkowy z grzechotką
RUS Ключ комбинированный с трещоткой
CZ Klíč oškoplochý ráčnový
H Csillag-villás kulcs racsnis

RO Cheie combinată cu crichet
F Clé mixte à cliquet
I Chiave combinata a cricchetto reversibile

E Llave combinada fija abierta y carraca
CN 棘轮两用扳手

72T CrV 6140 AS-DRIVE

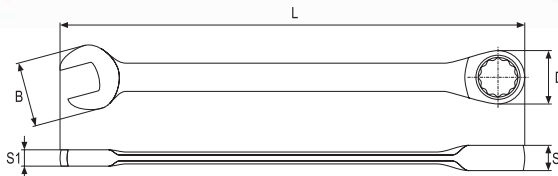

- application: service
- 72 teeth ratchet
- minimum operation angle: 5°
- surface finish: chromed, mirror
- przeznaczenie: serwis
- grzechotka 72 zęby
- minimalny kąt pracy: 5°
- wykończenie powierzchni: chromowana, polerowana



COLOR BOX



YATO	Ø (mm)	L (mm)	B (mm)	D (mm)	S1 (mm)	S2 (mm)	PCS packing:	
YT-01906	6	120	14.7	18.0	4.0	6.5	10	50/100
YT-01907	7	130	16.2	18.0	4.3	7.0	10	50/100
YT-01908	8	141	17.6	18.2	4.8	7.2	10	50/100
YT-01909	9	151	19.4	20.4	4.8	7.4	10	50/100
YT-0191	10	160	22.1	22.2	6.0	7.8	10	50/100
YT-0192	11	165	24.7	24.2	6.6	8.5	10	50/100
YT-0193	12	170	26.4	25.5	6.7	8.9	10	50/100
YT-0194	13	180	27.5	26.7	6.6	9.2	10	50/100
YT-0195	14	190	30.8	29.0	7.4	9.4	10	50/100
YT-0196	15	200	32.9	30.8	7.7	10.1	10	50/100
YT-0197	16	210	34.3	31.5	7.8	10.3	10	50/100

YATO	Ø (mm)	L (mm)	B (mm)	D (mm)	S1 (mm)	S2 (mm)	PCS packing:	
YT-0198	17	225	36.8	33.6	8.4	10.6	10	50/100
YT-0199	18	235	39.2	35.6	9.1	10.8	10	50/100
YT-0200	19	245	40.1	37.3	9.5	11.3	10	50/100
YT-0189	21	290	45.2	43.0	9.9	13.3	6	30/60
YT-0201	22	290	45.6	44.2	10.5	13.4	6	24/48
YT-0202	24	335	52.8	50.0	11.3	14.5	6	48
YT-0203	25	335	52.0	47.4	10.2	14.3	6	30
YT-0204	27	355	55.6	52.7	10.9	15.7	6	30
YT-0205	30	400	62.5	57.7	12.2	17.1	6	24
YT-0206	32	420	65.0	61.7	13.2	17.9	6	24

7
PCS

CrV
6140

72T



AS-DRIVE

1

- GB Combination ratchet wrench set
- D Knarrenringmaulschlüssel-satz
- PL Komplet kluczyz plasko-oczkwowych z grzechotką
- RUS Набор комбинированных ключей с трещоткой
- CZ Klíče ráčnové sada
- H Racsnis csillag-villás kulcs készlet
- RO Set cheie combinată
- F Set de clés mixte à cliquet
- I Set chiavi combinata a cricchetto
- E Juego de llaves planas con matraca
- CN 棘轮扳手组套





10, 12, 13, 14, 15, 17, 19 mm

YATO	
YT-0208	10/20

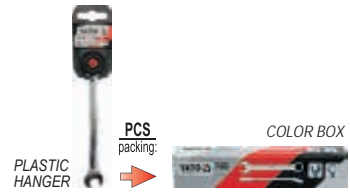
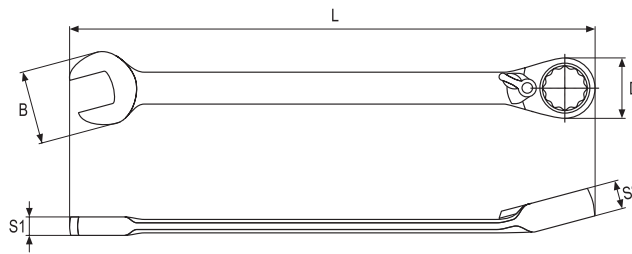
- GB Combination ratchet wrench
- D Ratschenringmaulschlüssel
- PL Kluczb plasko-oczkwowy z grzechotką
- RUS Ключ комбинированный с трещоткой
- CZ Klíč očkoplochy ráčnový
- H Csillag-villás kulcs racsnis
- RO Cheie combinată cu cricchet
- F Clé mixte à cliquet
- I Chiave combinata a cricchetto reversibile
- E Llave combinada fija abierta y carraca
- CN 棘轮两用扳手





YATO	Ø (mm)	L (mm)	B (mm)	D (mm)	S1 (mm)	S2 (mm)	PCS packing:	
YT-1651	8	140	17.5	19.0	6.0	7.2	10	50/100
YT-1652	9	150	19.8	20.7	6.4	7.5	10	50/100
YT-1653	10	160	22.1	23.1	6.4	7.9	10	50/100
YT-1654	11	165	23.9	25.0	6.6	8.4	10	50/100
YT-1655	12	170	27.1	26.0	6.5	8.9	10	50/100
YT-1656	13	180	27.9	27.6	7.1	9.1	10	50/100
YT-1657	14	190	31.6	28.3	7.3	9.5	10	50/100
YT-1658	15	200	32.8	31.4	8.1	9.8	10	50/100
YT-1659	16	210	33.9	32.9	8.4	10.3	10	50/100
YT-1660	17	225	38.0	34.5	8.7	10.5	10	50/100
YT-1661	18	235	39.8	36.9	9.3	10.7	10	50/100

YATO	Ø (mm)	L (mm)	B (mm)	D (mm)	S1 (mm)	S2 (mm)	PCS packing:	
YT-1662	19	245	41.8	38.3	9.5	11.3	10	50/100
YT-1663	20	245	41.9	38.1	9.7	11.4	6	30/60
YT-1664	21	290	44.9	43.0	9.8	13.6	6	30/60
YT-1665	22	290	44.8	43.8	10.0	13.6	6	30/60
YT-1666	23	290	44.9	43.3	10.3	13.7	6	24/48
YT-1667	24	330	52.0	49.4	10.2	14.5	6	24/48
YT-1669	26	360	56.3	53.6	12.1	15.7	6	30
YT-1670	27	360	55.6	52.9	12.2	16.1	6	30
YT-1671	28	360	56.1	53.6	12.6	16.0	6	24
YT-1672	30	400	62.1	58.0	11.9	17.2	6	24
YT-1673	32	420	64.1	62.0	12.9	17.7	6	24

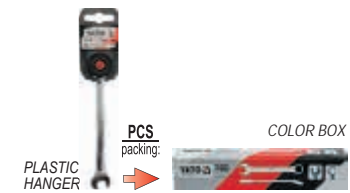
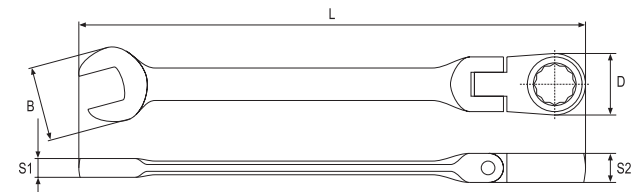
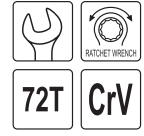
- GB Flexible ratchet combination wrench
- D Ratschenringmaulschlüssel
- PL Kluczb plasko-oczkwowy z grzechotką i przegubem
- RUS Ключ комбинированный с трещоткой
- CZ Klíč očkoplochy ráčnový
- H Csillag-villás kulcs racsnis
- RO Cheie combinată cu cricchet
- F Clé mixte à cliquet tête articulée
- I Chiave combinata a cricchetto testa mobile
- E Llave combinada fija abierta y carraca
- CN 活头棘轮两用扳手



YATO	Ø (mm)	L (mm)	B (mm)	D (mm)	S1 (mm)	S2 (mm)	PCS packing:	
YT-1674	8	140	18.0	19.6	6.3	7.3	10	50/100
YT-1675	9	145	19.7	21.1	4.7	7.6	10	50/100
YT-1676	10	160	22.8	23.2	6.3	7.8	10	50/100
YT-1677	11	160	24.0	24.7	5.4	8.5	10	50/100
YT-1678	12	170	26.4	26.7	6.8	8.8	10	50/100
YT-1679	13	180	28.4	27.3	7.2	9.1	10	50/100
YT-1680	14	185	29.5	28.7	6.8	9.4	10	50/100
YT-1681	15	195	32.9	30.8	7.2	9.8	10	50/100

YATO	Ø (mm)	L (mm)	B (mm)	D (mm)	S1 (mm)	S2 (mm)	PCS packing:	
YT-1682	16	210	34.4	33.3	7.6	10.3	10	50/100
YT-1683	17	230	36.7	35.7	8.3	10.5	10	50/100
YT-1684	18	235	39.0	35.9	8.0	10.8	10	50/100
YT-1685	19	245	40.8	37.6	9.5	11.2	10	50/100
YT-1686	20	245	40.9	38.2	8.8	11.1	6	30/60
YT-1687	21	290	45.0	42.8	9.8	13.6	6	30/60
YT-1688	22	290	45.2	42.7	9.8	13.5	6	30/60
YT-1690	24	330	51.3	48.7	10.4	14.5	6	24/48

1

- GB** Double open end spanner
- D** Doppelmaulschlüssel
- PL** Klucz płaski
- RUS** Ключ рожковый
- CZ** Ploché klíč
- H** Villáskulcs
- RO** Cheie fixă
- F** Clé plate
- I** Chiave piatta
- E** Llave fija
- CN** 双头呆扳手

- surface finish:
chromed, satin / mirror
- wykończenie powierzchni:
chromowana, satynowa / polerowana

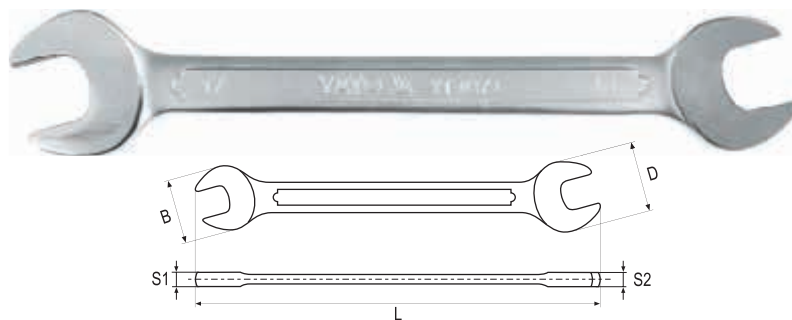

DIN 3110 CrV



COLOR BOX

YATO	Ø (mm)	L (mm)	B (mm)	D (mm)	S1 (mm)	S2 (mm)	PCS packing	
YT-0367	6x7	120	15.1	16.8	3.5	3.6	10	360/720
YT-0368	8x9	140	18.7	20.8	3.7	3.6	10	180/360
YT-0369	10x11	155	22.4	25.5	4.6	4.6	10	150/300
YT-0332	10x13	170	22.5	29.3	4.6	5.3	10	150/300
YT-0370	12x13	170	27.1	29.3	4.9	5.3	10	80/160
YT-0333	13x17	180	29.3	37.5	5.3	6.3	10	50/100
YT-0371	14x15	180	31.0	33.0	5.3	5.4	10	80/160
YT-0372	16x17	200	34.9	37.5	6.5	6.3	10	50/100

YATO	Ø (mm)	L (mm)	B (mm)	D (mm)	S1 (mm)	S2 (mm)	PCS packing	
YT-0334	17x19	220	37.5	38.7	6.3	6.3	10	50/100
YT-0373	18x19	220	38.7	41.0	6.6	6.3	10	50/100
YT-0374	20x22	230	42.1	46.8	7.1	6.8	10	30/60
YT-0375	21x23	245	44.4	48.6	7.3	6.9	10	30/60
YT-0376	24x27	260	51.6	56.9	8.1	8.1	5	20/40
YT-0377	25x28	270	52.3	57.9	8.4	8.3	5	20/40
YT-0378	30x32	295	61.4	65.1	8.0	8.6	5	15/30

- GB** Double open end spanner set
- D** Doppelmaulschlüsselsatz
- PL** Komplet kluczy płaskich
- RUS** Набор рожковых ключей
- CZ** Souprava plochého klíčů
- H** Kulcskészlet, villás
- RO** Set chei fixe
- F** Set de clés à tête fendue
- I** Set di chiavi piatte
- E** Juego de llaves fijas
- CN** 双头呆扳手组套

POUCH & COLOR BOX



DIN 3110

CrV

10 PCS 6x7, 8x9, 10x11, 12x13, 14x15, 16x17, 18x19, 20x22, 21x23, 24x27 mm

YATO YT-0380 6

12 PCS 6x7, 8x9, 10x11, 12x13, 14x15, 16x17, 18x19, 20x22, 21x23, 24x27, 25x28, 30x32 mm

YATO YT-0381 8

- GB** Double open end spanner
- D** Doppelmaulschlüssel
- PL** Klucz płaski
- RUS** Ключ рожковый
- CZ** Ploché klíč
- H** Villáskulcs
- RO** Cheie fixă
- F** Clé plate
- I** Chiave piatta
- E** Llave fija
- CN** 双头呆扳手

- surface finish:
chromed, satin
- wykończenie powierzchni:
chromowana, satynowa

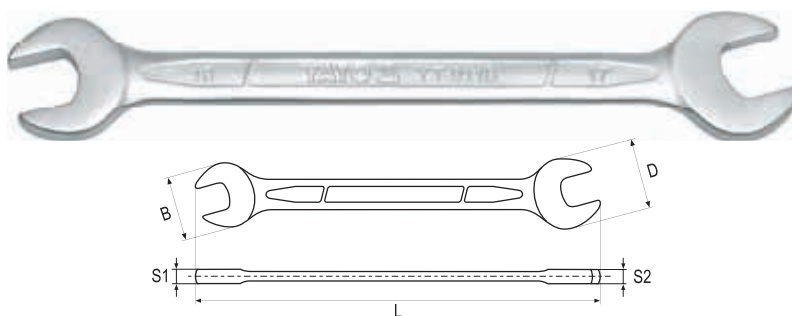

DIN 3110 CrV 6140

COLOR BOX



YATO	Ø (mm)	L (mm)	B (mm)	D (mm)	S1 (mm)	S2 (mm)	PCS packing	
YT-0107	6x7	128	15.5	17.5	3.8	3.8	10	600
YT-0109	8x9	146	19.4	21.4	4.3	4.3	10	360
YT-0110	8x10	146	19.4	21.4	4.3	4.3	10	360
YT-0111	10x11	162	23.5	25.7	5.0	5.0	10	360
YT-0112	10x13	175	27.7	30.2	5.3	5.3	10	120
YT-0113	12x13	175	27.7	30.2	5.3	5.3	10	120
YT-0115	14x15	191	31.7	33.7	5.8	5.8	10	120
YT-0117	13x17	195	31.7	38.7	6.2	6.2	10	120
YT-0118	16x17	212	36.2	38.2	6.3	6.3	10	100

YATO	Ø (mm)	L (mm)	B (mm)	D (mm)	S1 (mm)	S2 (mm)	PCS packing	
YT-0119	17x19	224	40.2	42.2	6.8	6.8	10	100
YT-0120	18x19	224	40.2	42.2	6.8	6.8	10	100
YT-0122	19x22	237	44.2	48.2	7.5	7.5	10	60
YT-0123	20x22	237	44.2	48.2	7.5	7.5	10	60
YT-0125	21x23	247	46.2	50.2	7.8	7.8	10	60
YT-0127	24x27	268	53.2	57.7	8.4	8.4	5	40
YT-0128	25x28	268	53.2	57.7	8.4	8.4	5	40
YT-0132	30x32	295	64.2	68.2	9.4	9.4	5	40

- GB** Double open end spanner set
- D** Doppelmaulschlüsselsatz
- PL** Komplet kluczy płaskich
- RUS** Набор рожковых ключей
- CZ** Souprava plochého klíčů
- H** Kulcskészlet, villás
- RO** Set chei fixe
- F** Set de clés à tête fendue
- I** Set di chiavi piatte
- E** Juego de llaves fijas
- CN** 双头呆扳手组套

POUCH & COLOR BOX



DIN 3110

CrV 6140

10 PCS 6x7, 8x9, 10x11, 12x13, 14x15, 16x17, 18x19, 20x22, 21x23, 24x27 mm

YATO YT-0150 6

12 PCS 6x7, 8x9, 10x11, 12x13, 14x15, 16x17, 18x19, 20x22, 21x23, 24x27, 25x28, 30x32 mm

YATO YT-0152 8

- GB Double ratchet spanner set
- D Ringschlüsselsatz
- PL Klucze oczkowe z grzechotką
- RUS Набор ключей накидных
- CZ Očkové klíče
- H Csillagkulcs készlet
- RO Set chei inelare
- F Set de clés à œil à cliquet
- I Set chiavi a cricchetto
- E Llaves de anillo
- CN 双头梅花棘轮扳手组套



5 PCS RATCHET WRENCH CrV 6140 72T



8x9, 10x11, 12x13, 14x15, 17x19 mm

YATO	
YT-5038	10/30

- GB Bi-hexagonal ring spanner
- D Doppelringschlüssel
- PL Klucz oczkowy odgięty
- RUS Ключ накидной изогнутый
- CZ Očkový klíč ohnutý
- H Hajlítotszárú csillagkulcs
- RO Cheie inelaro-curbată
- F Clé contre-coudée
- I Chiave poligonale doppio piegato
- E Llave de estrella
- CN 双头高颈梅花扳手



DIN 838 CrV AS-DRIVE

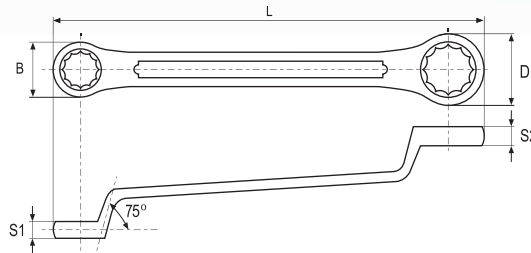

- application: industry
- surface finish: chromed, satin / mirror
- przeznaczenie: przemysł
- wykończenie powierzchni: chromowana, satynowa / polerowana



YATO	Ø (mm)	L (mm)	B (mm)	D (mm)	S1 (mm)	S2 (mm)	PCS packing	
YT-0383	6x7	165	11.0	12.7	5.4	5.5	10	200/400
YT-0384	8x9	185	13.9	15.5	6.8	7.2	10	100/200
YT-0385	10x11	200	16.3	17.6	6.8	7.2	10	100/200
YT-0386	12x13	220	19.6	21.5	7.2	7.7	10	60/120
YT-0387	14x15	230	23.6	21.9	8.9	9.1	10	50/100
YT-0388	16x17	255	24.6	26.4	8.6	9.3	10	30/60

YATO	Ø (mm)	L (mm)	B (mm)	D (mm)	S1 (mm)	S2 (mm)	PCS packing	
YT-0389	18x19	270	27.5	28.8	10.5	10.2	5	25/50
YT-0390	20x22	290	30.9	33.4	10.5	11.4	5	20/40
YT-0391	21x23	310	31.9	34.4	11.8	12.4	5	20/40
YT-0392	24x27	330	36.2	40.6	11.5	13.2	5	20/40
YT-0394	30x32	390	44.0	47.1	13.8	14.9	3	15/30

- GB Bi-hexagonal ring spanner set
- D Doppelringschlüsselsatz
- PL Komplet kluczy oczkowych odgiętych
- RUS Набор ключей накидных изогнутых
- CZ Klíče očkové vyhnuté sada
- H Csillagkulcs készlet
- RO Set chei inelare cu cot
- F Set de clés contre-coudées
- I Set chiavi poligonali doppie piegate
- E Juego de llaves de estrella acodadas
- CN 双头高颈梅花扳手组套



DIN 838

CrV

AS-DRIVE



8 PCS 6x7, 8x9, 10x11, 12x13, 14x15, 16x17, 18x19, 20x22 mm

YATO 6
YT-0396

12 PCS 6x7, 8x9, 10x11, 12x13, 14x15, 16x17, 18x19, 20x22, 21x23, 24x27, 25x28, 30x32 mm

YATO 4
YT-0398

- GB Bi-hexagonal ring spanner
- D Doppelringschlüssel
- PL Klucz oczkowy odgięty
- RUS Ключ накидной изогнутый
- CZ Očkový klíč ohnutý
- H Hajlítotszárú csillagkulcs
- RO Cheie inelaro-curbată
- F Clé contre-coudée
- I Chiave poligonale doppio piegato
- E Llave de estrella
- CN 双头高颈梅花扳手



AS-DRIVE

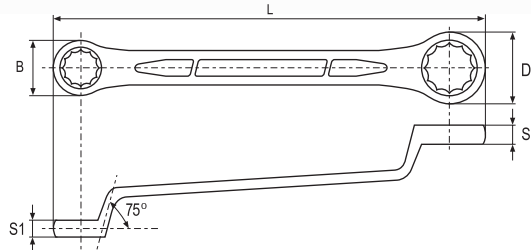

- application: industry
- surface finish: chromed, satin
- przeznaczenie: przemysł
- wykończenie powierzchni: chromowana, satynowa



YATO	Ø (mm)	L (mm)	B (mm)	D (mm)	S1 (mm)	S2 (mm)	PCS packing	
YT-02330	32x36	408	52	46	17.5	17.5	5	20
YT-02331	36x41	448	58	52	18.0	18.0	5	20
YT-02332	41x46	483	65	58	18.5	18.5	5	15

YATO	Ø (mm)	L (mm)	B (mm)	D (mm)	S1 (mm)	S2 (mm)	PCS packing	
YT-02333	46x50	495	71	65	19.0	19.0	5	10
YT-02334	50x55	538	78	71	19.5	19.5	5	10

1

- GB Bi-hexagonal ring spanner
- D Doppelringschlüssel
- PL Klucz oczkowy odgięty
- RUS Ключ накидной изогнутый
- CZ Očkový klíč ohnutý
- H Hajlítotszárú csillagkulcs
- RO Cheie inelara-curbata
- F Clé contre-coudée
- I Chiave poligonale doppio piegato
- E Llave de estrella
- CN 双头高颈梅花扳手

- application: industry
- maximum torque exceeding DIN and ANSI standards by 60%
- surface finish: chromed, satin
- przeznaczenie: przemysł
- maksymalny moment obrotowy większy o 60% niż w standardach DIN i ANSI
- wykończenie powierzchni: chromowana, satynowa

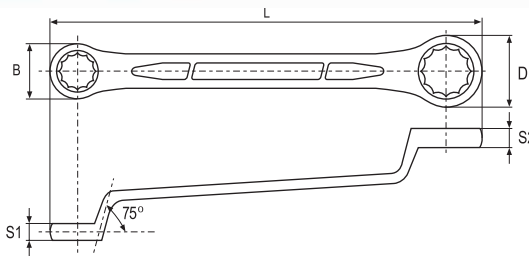

DIN 838 CrV 6140 AS-DRIVE



YATO	Ø (mm)	L (mm)	B (mm)	D (mm)	S1 (mm)	S2 (mm)	PCS packing	Box
YT-0207	6x7	168	10.4	11.9	5.7	6.2	10	320
YT-0209	8x9	183	13.3	14.8	6.7	7.2	10	160
YT-0211	10x11	198	16.3	17.7	7.7	8.8	10	100
YT-0213	12x13	217	19.2	20.6	8.7	9.2	10	100
YT-0215	14x15	239	22.1	23.4	9.6	10.1	5	50
YT-0217	16x17	260	25.0	26.4	10.6	10.9	5	60

YATO	Ø (mm)	L (mm)	B (mm)	D (mm)	S1 (mm)	S2 (mm)	PCS packing	Box
YT-0219	18x19	292	27.9	29.4	11.2	11.5	5	60
YT-0222	20x22	318	30.8	33.7	11.8	12.5	5	30
YT-0223	21x23	326	32.3	35.2	12.1	12.8	5	30
YT-0227	24x27	329	36.6	40.7	13.1	14.0	5	30
YT-0228	25x28	347	38.1	42.5	14.0	14.3	2	16
YT-0232	30x32	362	45.2	49.2	15.0	15.7	2	16

- GB Bi-hexagonal ring spanner set
- D Doppelringschlüsselsatz
- PL Komplet kluczy oczkowych odgiętych
- RUS Набор ключей накидных изогнутых
- CZ Klíče očkové vyhnuté sada
- H Csillagkulcs készlet

- RO Set chei inelare cu cot
- F Set de clés contre-coudées
- I Set chiavi poligonali doppio piegate
- E Juego de llaves de estrella acodadas
- CN 双头高颈梅花扳手组套

POUCH & COLOR BOX

DIN 838 CrV 6140 AS-DRIVE



8 PCS 6x7, 8x9, 10x11, 12x13, 14x15, 16x17, 18x19, 20x22 mm

10 PCS 6x7, 8x9, 10x11, 12x13, 14x15, 16x17, 18x19, 20x22, 21x23, 24x27 mm

12 PCS 6x7, 8x9, 10x11, 12x13, 14x15, 16x17, 18x19, 20x22, 21x23, 24x27, 25x28, 30x32 mm

YATO	Box
YT-0248	6

YATO	Box
YT-0250	10

YATO	Box
YT-0252	4

- GB Insulated ring wrench
- D Einringschlüssel vollisoliert
- PL Klucz oczkowy odgięty izolowany
- RUS Ключ накидной односторонний изолированный
- CZ Očkový klíč, izolovaný
- H Hajlítotszárú csillagkulcs
- RO Cheie inelara izolata
- F Clé polygonale coudée isolée
- I Chiave poligonale piegato isolato
- E Llave de estrella acodada aislante
- CN 绝缘梅花扳手

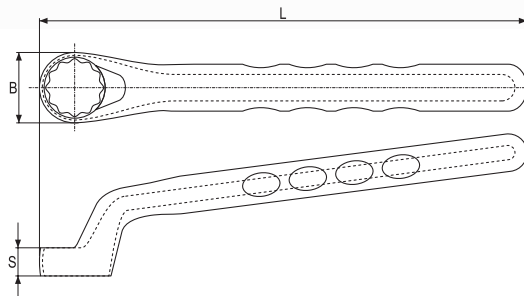

CrV 1000 V DVE

1000V VDE CERTIFICATE EN 60900:2012

POLYBAG



YATO	Ø (mm)	L (mm)	B (mm)	S (mm)	Box
YT-20980	6	150	16.0	5.5	6/126
YT-20981	7	150	18.0	5.7	6/126
YT-20982	8	155	19.0	6.1	6/126
YT-20983	9	155	20.0	7.2	6/126
YT-20984	10	170	21.0	7.3	6/90
YT-20985	11	170	22.5	7.7	6/90
YT-20986	12	190	22.5	8.5	6/90
YT-20987	13	190	26.5	9.0	6/90
YT-20988	14	205	28.0	9.5	6/90
YT-20989	15	205	29.0	9.5	6/90

YATO	Ø (mm)	L (mm)	B (mm)	S (mm)	Box
YT-20990	16	215	31.0	10.2	6/90
YT-20991	17	215	32.0	10.7	6/90
YT-20992	18	230	35.0	11.5	6/90
YT-20993	19	230	36.0	12.0	6/90
YT-20994	21	245	39.0	13.0	6/48
YT-20995	22	245	41.0	12.2	6/48
YT-20996	24	265	44.0	13.0	6/48
YT-20997	27	290	48.0	14.5	4/40
YT-20998	30	310	52.0	15.2	4/40
YT-20999	32	310	55.0	16.5	4/40

GB Insulated open end wrench
D Doppelmautschlüssel isoliert
PL Klucz płaski izolowany
RUS Ключ рожковый односторонний изолированный

CZ Otevřený klíč, izolovaný
H Villáskulcs
RO Cheie fixă izolată
F Clé plate isolée

I Chiave piatta isolato
E Llave fija aislante
CN 绝缘开口扳手

POLYBAG



CrV

1000
V



1

1000V
VDE CERTIFICATE
EN 60900:2012

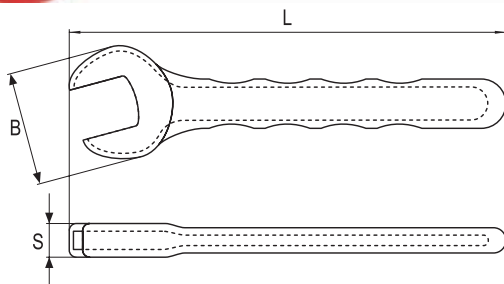

YATO	Ø (mm)	L (mm)	B (mm)	S (mm)	
YT-20950	6	90	23	7.0	6/108
YT-20951	7	90	25	7.0	6/108
YT-20952	8	100	27	7.5	6/108
YT-20953	9	100	29	7.5	6/108
YT-20954	10	110	31	8.0	6/108
YT-20955	11	110	34	8.5	6/108
YT-20956	12	130	36	8.5	6/108
YT-20957	13	135	39	10.5	6/108
YT-20958	14	145	40	10.5	6/72
YT-20959	15	150	42	11.5	6/72
YT-20960	16	160	43	11.5	6/72
YT-20961	17	160	47	12.5	6/72
YT-20962	18	175	50	13.0	6/72
YT-20963	19	175	53	14.0	6/72
YT-20964	21	195	55	14.0	6/66
YT-20965	22	195	58	14.0	6/66
YT-20966	24	225	62	16.5	6/66
YT-20967	27	250	69	18.0	4/60
YT-20968	30	290	75	19.0	4/48
YT-20969	32	310	79	20.0	4/48

GB Ring impact wrench
D Schlagringschlüssel
PL Klucz do pobijania oczkowy
RUS Ключ закрытый для растряски
CZ Klíč maticový očkový rázový
H Útőcsillagkulcs
RO Cheie inelară cu bățator
F Clé à frapper à ceil
I Chiave poligonale semplice a percussione
E Llave de muletilla para usarse dando golpes
CN 敲击梅花扳手

- application: industry
- 12 point profile
- AS-DRIVE system
- drop forged
- surface finish: black oxidised
- przeznaczenie: przemysł
- profil 12-kątny
- system AS-DRIVE
- kute
- wykończenie powierzchni: czarna, oksydowana

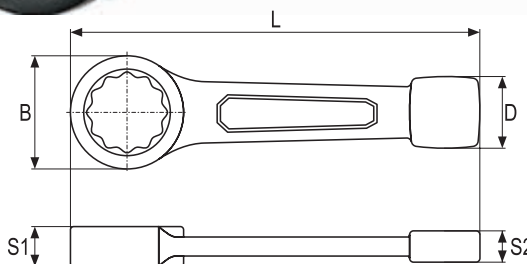

DROP
FORGED
KUTE

CrV

AS-DRIVE

YATO	Ø (mm)	L (mm)	B (mm)	D (mm)	S1 (mm)	S2 (mm)	
YT-1601	24	160	41	31	15.0	10	5/25
YT-1602	27	185	47	33	15.0	12	5/50
YT-1603	30	190	51	35	16.5	14	5/25
YT-1604	32	195	54	37	16.5	15	5/25
YT-1605	36	210	60	39	20.0	17	5/10
YT-1606	38	210	60	39	20.0	17	5/10
YT-1607	41	225	66	42	20.0	18	5/10

YATO	Ø (mm)	L (mm)	B (mm)	D (mm)	S1 (mm)	S2 (mm)	
YT-1608	46	240	74	44	22.0	19	5/10
YT-1609	50	250	80	45	23.0	20	5/10
YT-1610	55	270	86	55	25.0	22	5/10
YT-1611	58	270	86	55	25.0	22	5
YT-1612	60	270	92	60	25.0	23	5
YT-1613	65	290	100	65	30.0	24	5
YT-1614	70	310	108	70	32.0	25	5

GB Open end impact wrench
D Schlagschraubenschlüssel
PL Klucz do pobijania płaski
RUS Ключ плоский для растряски
CZ Klíč maticový plochý rázový
H Útőlaposkulcs
RO Cheie fixă cu bățator
F Clé à frapper plate
I Chiave a forchetta semplice a percussione
E Llave de boca abierta para usarse dando golpes
CN 敲击开口扳手

- application: industry
- head offset: 15°
- drop forged
- surface finish: black oxidised
- przeznaczenie: przemysł
- kąt odchylenia główki: 15°
- kute
- wykończenie powierzchni: czarna, oksydowana

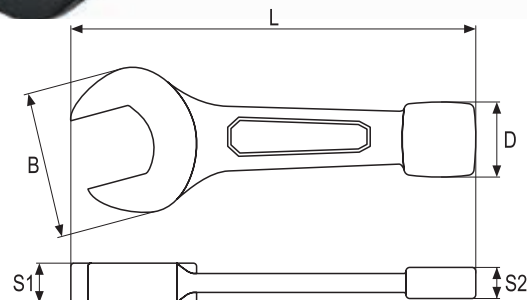

DROP
FORGED
KUTE

CrV

YATO	Ø (mm)	L (mm)	B (mm)	D (mm)	S1 (mm)	S2 (mm)	
YT-1615	27	180	55	33	15	12	5/25
YT-1616	30	187	63	35	17	14	5/25
YT-1617	32	195	67	37	18	15	5/25
YT-1618	36	210	77	39	18	17	5/10

YATO	Ø (mm)	L (mm)	B (mm)	D (mm)	S1 (mm)	S2 (mm)	
YT-1619	41	225	89	42	20	18	5/10
YT-1620	46	255	98	44	20	19	5/10
YT-1621	50	280	107	45	22	20	5
YT-1622	55	310	118	55	25	22	5

1

- GB Half-moon spanner
- D Starter- und Blockschlüssel
- PL Klucz oczkowy typu „C”
- RUS Ключ накладной изогнутый „C”
- CZ Kľič očkoplochý typ „C”
- H Félhold alakú csillagkulcs
- RO Cheie inelară semi-lună
- F Clé à œil „C”
- I Chiave poligonale doppio speciale tipo „C”
- E Llave de estrella tipo „C”
- CN C型梅花扳手

- application: industry
- excellent for work in tight spaces
- used for dismantling of collector tubes, alternators and starters
- surface finish: chromed, satin
- przeznaczenie: przemysł
- do pracy w miejscach szczególnie trudnodostępnych
- ułatwia odkręcanie kolektorów, alternatorów i rozruszników samochodowych
- wykończenie powierzchni: chromowana, satynowa

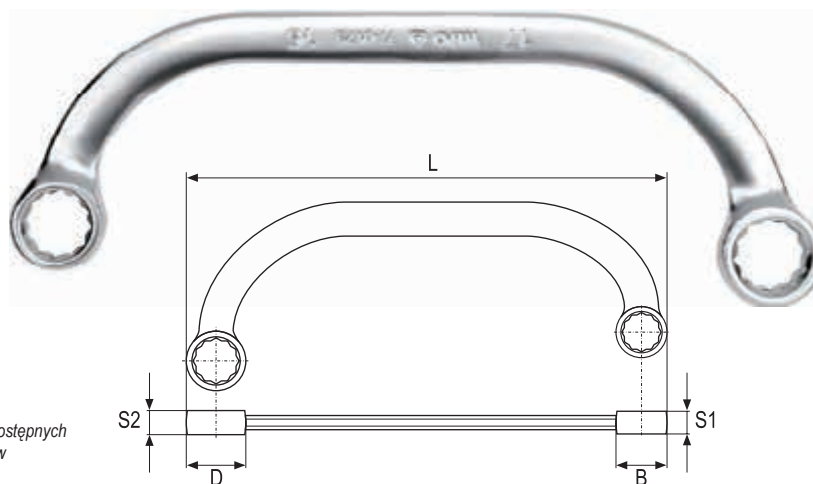

CrV 6140 AS-DRIVE

YATO	Ø (mm)	L (mm)	B (mm)	D (mm)	S1 (mm)	S2 (mm)	PCS
YT-0170	10x12	145	16.8	19.2	6.8	6.8	10/60
YT-0171	11x13	170	18.5	21.2	8.4	8.6	10/60
YT-0172	14x15	195	22.8	25.8	9.2	9.9	10/60

YATO	Ø (mm)	L (mm)	B (mm)	D (mm)	S1 (mm)	S2 (mm)	PCS
YT-0173	16x17	220	26.2	28.6	9.9	10.5	10/60
YT-0175	19x22	260	28.7	32.9	10.4	10.9	10/60

- GB Flare nut wrench
- D Schraubenschlüssel, halboffen
- PL Klucz oczkowy półotwarty
- RUS Ключ накладной полуоткрытый
- CZ Kľič prstencový polootevřený
- H Csuklós, nyitott
- RO Cheie inelară semideschisă
- F Clé mixte à cliquet
- I Chiave poligonale semiaperto
- E Llave semiabierta
- CN 油管扳手

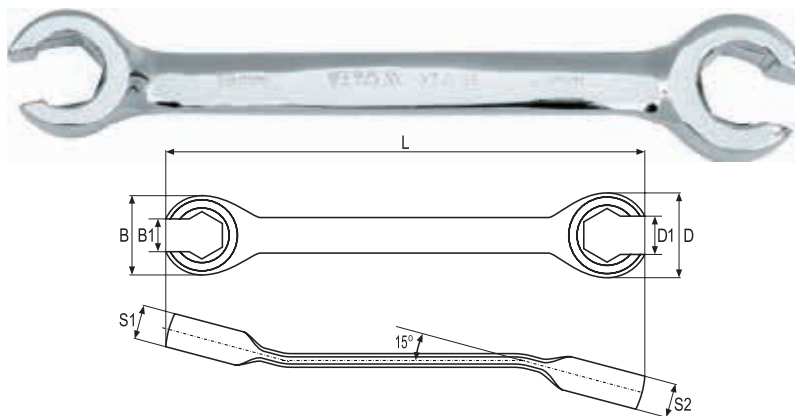

CrV 6140

YATO	Ø (mm)	L (mm)	B (mm)	D (mm)	B1 (mm)	D1 (mm)	S1 (mm)	S2 (mm)	PCS packing
YT-0135	8x10	140	18.7	21.8	6.2	7.2	7.7	8.4	10 200/400
YT-0136	11x12	160	21.2	24.0	8.1	9.2	8.5	9.5	10 100/200
YT-0137	13x14	175	26.3	27.3	9.6	10.7	9.6	10.5	10 100/200
YT-0138	15x17	190	31.2	31.2	11.8	13.0	11.5	10.9	10 50/100

YATO	Ø (mm)	L (mm)	B (mm)	D (mm)	B1 (mm)	D1 (mm)	S1 (mm)	S2 (mm)	PCS packing
YT-01385	17x19	195	29.0	31.2	14.5	15.0	12.4	12.8	10 50/100
YT-0139	19x21	230	36.3	42.1	14.7	16.7	12.4	12.8	10 50/100
YT-0140	22x24	250	42.7	44.2	17.1	18.6	13.2	13.9	10 50/100

COLOR BOX



- GB Flare nut wrench set
- D Schraubenschlüssel, halboffen
- PL Zestaw kluczy oczkowych półotwartych
- RUS Ключ накладной полуоткрытый
- CZ Kľič prstencový polootevřený
- H Csuklós, nyitott
- RO Cheie inelară semideschisă
- F Set de clés à tête fendue
- I Set chiavi poligonali semiaperte
- E Llave semiabierta
- CN 油管扳手组套

4 PCS



CrV 6140



8x10, 11x12, 13x14, 15x17 mm

YATO	YT-0143	25/50
------	---------	-------

- GB Flexible flare nut wrench set
- D Schraubenschlüssel, halboffen mit Gelenk
- PL Komplet kluczy oczkowych półotwartych z przegubem
- RUS Ключ накладной полуоткрытый с шарниром
- CZ Kľič prstencový polootevřený s kloubelem
- H Csuklós, nyitott csillagkulcs
- RO Cheie inelară semideschisă, cu articulație
- F Set de clés à tête fendue articulées
- I Set chiavi poligonali a due bocche aperte con testa snodata
- E Llave semiabierta con una junta
- CN 活头油管扳手组套

7 PCS



CrV 6140

AS-DRIVE

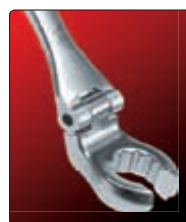

PLASTIC HANGER



YATO	YT-0190	5/20
------	---------	------

8, 10, 11, 12, 13, 14, 17 mm

4
PCS



CrV
6150

- GB Torx ring spanner set
- D Torx-Ringschlüsselsatz
- PL Komplet kluczy oczkowych Torx
- RUS Набор накидных ключей
- CZ Očkové klíče
- H Csillagkulcs készlet
- RO Chei inelare
- F Set de clés à ceil

- I Set chiavi doppie Torx
- E Llaves de anillo Torx
- CN 星型扳手组套



E6xE8, E10xE12, E14xE18, E20xE24

SLIDING
CARD



YATO		
YT-0530		10/60

- GB L-type socket wrench
- D Steckschlüssel gebogen
- PL Klucz nasadowy typu „L”
- RUS Ключ торцевой „L” типа

- CZ Nástrčný kľúč fajfkový
- H Kulcs, dugó-pipa
- RO Cheie tubulara cu cot tip „L”
- F Clé à pipe en „L”

- I Chiave a tubo doppio tipo „L”
- E Llave de vaso „L”
- CN L 型套筒扳手

CrV
6140

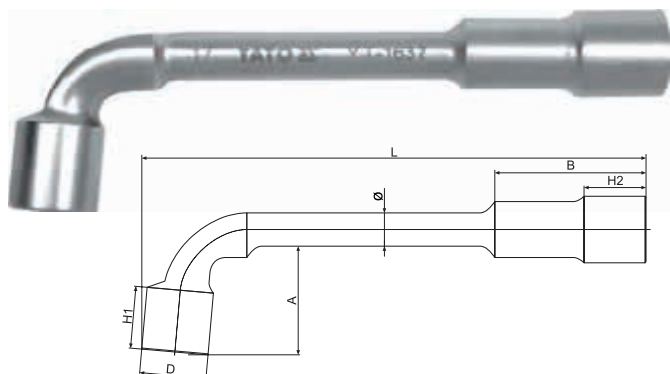

YATO	Ø (mm)	L (mm)	B (mm)	H1 (mm)	H2 (mm)	A (mm)	D (mm)	Ø (mm)	
YT-1627	7	106	27.0	10.2	10.1	21.0	10.7	7	12/60
YT-1628	8	117	29.5	12.3	11.9	18.5	12.2	9	12/60
YT-1629	9	121	31.7	13.4	12.8	19.1	13.2	10	12/60
YT-1630	10	131	35.1	16.4	16.9	23.3	15.0	10	12/60
YT-1631	11	138	36.0	16.5	16.8	24.7	16.3	11	12/60
YT-1632	12	147	42.5	17.9	18.2	17.9	18.0	12	12/60
YT-1633	13	154	44.2	18.5	19.1	30.1	19.3	12	12/60
YT-1634	14	162	47.0	19.3	20.3	30.2	20.8	13	12/60
YT-1635	15	173	48.9	20.6	21.6	31.6	22.3	13	12/60
YT-1636	16	182	55.0	23.2	23.1	37.3	23.6	14	12/60
YT-1637	17	188	57.0	25.1	25.5	37.9	25.1	14	12/36
YT-1638	18	192	57.1	25.1	24.6	40.1	26.0	14	12/36
YT-1639	19	207	62.3	26.9	27.4	41.6	28.2	16	12/36
YT-1640	20	215	62.4	27.0	28.3	42.4	29.2	16	6/24
YT-1641	21	221	65.0	30.5	30.6	54.0	30.2	16	6/24
YT-1642	22	232	67.5	30.8	30.6	49.1	31.7	16	6/24
YT-1644	24	253	78.2	32.3	31.7	53.5	33.6	17	6/18
YT-1647	27	288	85.3	36.9	36.4	54.7	37.6	20	6/12
YT-1649	30	310	95.0	38.4	38.6	65.3	42.0	22	6/12
YT-1650	32	339	99.2	40.4	40.5	66.8	43.8	22	6

- GB Heavy duty tubular socket wrench
- D Rohrsteckschlüsselsatz
- PL Klucz rurowy kuty
- RUS Ключ двухлучевой с головками
- CZ Klíče trubkové
- H Csőkulcs
- RO Cheie pt. țevi
- F Clé à tube double droite
- I Chiave a tubo
- E Llave de tubería
- CN 小轮胎扳手



CrV
40

AS-DRIVE

COLOR BOX



YATO	Ø (mm)	D1 (mm)	D2 (mm)	D (mm)	L (mm)	PCS packing:	
YT-4915	8x9	13	14	3	110	10	60/240
YT-4916	10x11	15	16	5	120	10	60/240
YT-4917	12x13	18	19	6	140	10	60/120
YT-4918	14x15	20	22	6	145	10	60/120
YT-4919	16x17	23	24	7	155	10	60/120
YT-4920	18x19	25	26	8	165	5	40/80

YATO	Ø (mm)	D1 (mm)	D2 (mm)	D (mm)	L (mm)	PCS packing:	
YT-4921	20x22	28	30	8	170	5	30/60
YT-4922	21x23	29	31	10	185	5	30/60
YT-4923	24x26	33	35	12	190	5	40
YT-4924	25x28	34	37	12	205	5	40
YT-4925	27x29	37	39	12	210	5	40
YT-4926	30x32	40	42	13	210	5	20

- GB Tubular socket wrench handle
- D Stellstab für Rohrschlüssel
- PL Pokręto do kluczy rurowych
- RUS Вороток к трубчатым ключам

- CZ Tyčka k trubkovým kľúčům
- H Forgatókar dugókulcshez
- RO Clupă pt. chei tubulare
- F Support de clés à tube

- I Spina di manovra per chiave a tubo doppia
- E Mango para las llaves de tubo
- CN 旋棒

COLOR BOX



CrV
40



YATO	L (mm)	mm	PCS packing:	
YT-4927	190	2.5; 4.5; 5.5	50	150
YT-4928	280	6.5; 7.5; 9.5; 11.5; 12.5	50	100

- GB Ratchet wrench
- D Gerüstratsche
- PL Klucz nasadowy z grzechotką
- RUS Ключ торцевой с трехоткой
- CZ Ráčňový kľúč prúchozí
- H Kettős racsnis kulcs
- RO Cheie tubulara cu clichet
- F Clé à tube à cliquet
- I Chiavi a cricchetto per ponteggi
- E Llave de vaso con carraca
- CN 尖尾棘轮扳手



PLASTIC
HANGER



CrV
32T



COLD FORGED
KUTE NA ZIMNO

YATO	Ø (mm)	L (mm)	
YT-4937	19x22	315	2/40

1

- GB** Double ratchet wrench
D Gerüstratsche
PL Dwustronny klucz nasadowy z grzechotką
RUS Ключ торцовый с трещоткой
CZ Ráčnový kľúč príchozí dvoustranný
H Kettős racsnis kulcs
RO Cheie tubulara dubla cu clictet
F Clé à œil à cliquet
I Chiave a cricco doppio
E Llave de vaso con carraca
CN 尖尾棘轮扳手

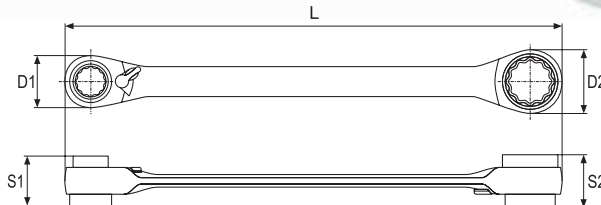

CrV 72T RATCHET WRENCH

DOUBLE BLISTER

YATO	Ø (mm)	L (mm)	D1 (mm)	D2 (mm)	S1 (mm)	S2 (mm)	PCS
YT-4945	10x13x17x19	200	29	35	17	22	5/50

- GB** Socket wrench with handle
D Steckschlüssel
PL Klucz nasadowy z rączką
RUS Ключ торцевой
CZ Nástrčný kľúč
H Kulcs
RO Cheie tubulara
F Clé à tube
I Chiave a cricco doppio
E Llave
CN 六角套筒螺丝批

COLOR BOX



CrV HRC 44

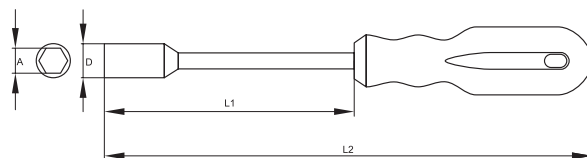

YATO	Ø (mm)	D (mm)	L1 (mm)	L2 (mm)	PCS packing
YT-1541	5	8.0	125	242	6 120
YT-1542	6	9.1	125	242	6 120
YT-1543	7	10.9	125	242	6 120
YT-1544	8	12.0	125	242	6 120
YT-1545	9	13.0	125	242	6 120
YT-1546	10	14.1	125	242	6 120
YT-1547	11	15.9	125	242	6 120
YT-1548	12	16.9	125	242	6 120
YT-1549	13	18.0	125	242	6 120

- GB** T-type deep socket wrench with rotary handle
D Steckschlüssel vom Typ „T“ mit drehbarem Handgriff
PL Klucz nasadowy typu „T“ z obrotową rękociością
RUS Торцовый ключ типа „Т“ с вращательной ручкой
CZ Kľúč nástrčný typ „T“ s otočnou rukojeťou
H „T“ típusú dugókulcs, forgatható karral
RO Cheie tubulară de tip „T“ cu mâner rotativ
F Clé à tube
I Chiave tipo „T“ con manico scorrevole
E Llave tubular „T“ con un mango giratorio
CN T型套筒扳手



CrV 6140 AS-DRIVE

COLOR CARDBOARD

- GB** T-type adapter with rotary handle
D Adapter vom Typ „T“ mit drehbarem Handgriff
PL Adapter typu „T“ z obrotową rękociością
RUS Адаптер типа „Т“ с вращательной ручкой
CZ Adaptér typ „T“ s otočnou rukojeťou
H „T“ típusú adapter, forgatható karral
RO Adaptor tip „T“ cu mâner rotativ
F Adaptateur
I Adattatore tipo „T“ con manico scorrevole
E Adaptador „T“ con un mango giratorio
CN T型套筒扳手



COLOR CARDBOARD

1/4" 3/8" 1/2" 6.3mm 10mm 12.5mm CrV 6140

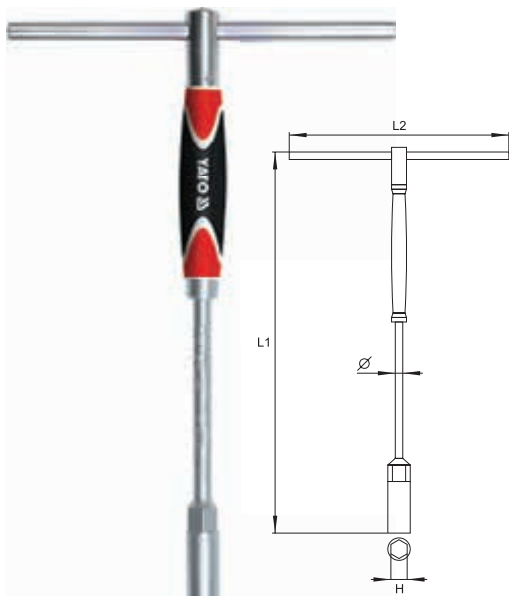

- ergonomic handle
- movable handle with position locking system
- long bar for work in deeply set, difficult to reach places
- ergonomiczna rękojeść
- przesuwane pokrętko z blokadą położenia
- długi trzpień umożliwiający pracę w głębokich wnękach

YATO	Ø H	L1 (mm)	L2 (mm)	Ø (mm)	PCS
YT-1552	8 mm	310	200	10	10/40
YT-1553	9 mm	310	200	10	10/40
YT-1554	10 mm	310	200	10	10/40
YT-1555	11 mm	310	200	10	10/40
YT-1556	12 mm	310	200	10	10/40
YT-1557	13 mm	310	200	10	10/40
YT-1558	14 mm	310	200	10	10/40
YT-1559	15 mm	310	200	10	10/40

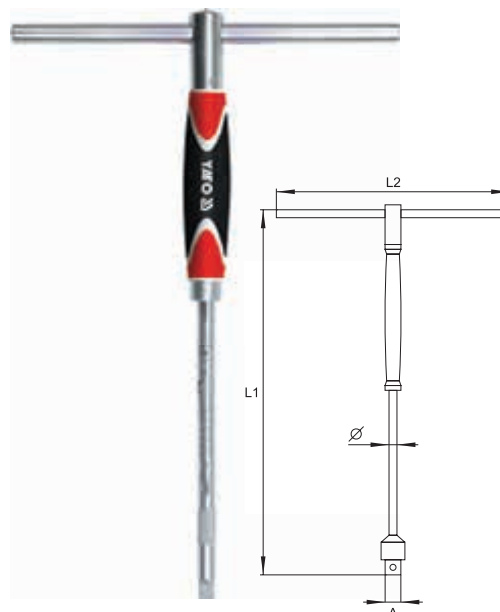

- ergonomic handle
- movable handle with position locking system
- long bar for work in deeply set, difficult to reach places
- ergonomiczna rękojeść
- przesuwane pokrętko z blokadą położenia
- długi trzpień umożliwiający pracę w głębokich wnękach

YATO	Ø H	L1 (mm)	L2 (mm)	Ø (mm)	PCS
YT-1565	1/4" (6.3 mm)	310	200	8	10/40
YT-1566	3/8" (9.5 mm)	310	200	10	10/40
YT-1567	1/2" (12.7 mm)	310	200	10	10/40

- GB** Insulated T-handle wrench
D Steckschlüssel T-griff vollisoliert
PL Rękojeść typu „T” izolowana
RUS Ручка Т-образная изолированная
CZ Klíč nástrčný typ „T”, izolovaný

- H** „T” típusú dugókulcs
RO Manerț tip „T” izolat
F Clé à tube en „T” isolée
I Chiave a bussola tipo „T” isolati
E Llave tubular „T” aislante
CN 绝缘T型扳手

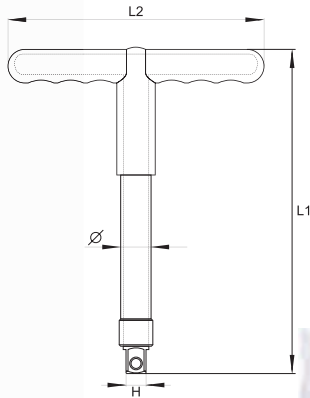
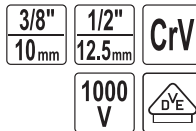

POLYBAG

1000V
VDE CERTIFICATE
EN 60900:2012

YATO	Ø H	L1 (mm)	L2 (mm)	Ø (mm)	
YT-21095	3/8" (9.5 mm)	207	160	15.6	4/32
YT-21096	1/2" (12.7 mm)	207	160	19.3	4/32

- GB** T-handle swivel socket wrench
D T-Griff Steckchlüssel mit Gelenk
PL Klucz nasadowy z przegubem typu „T”
RUS Ключ торцевой с карданом Т-образный
CZ Hlavice ohebná na T-rukojeti matny povrch
H Csuklós „T” kulcs adatai

- RO** Cheie tubulară cu cruce cardanica tip „T”
F Clé à poignée en „T” longue a cardan
I Chiave a bussola a „T” con snodo
E Llave vaso en „T” con cardan
CN 滑杆方向T型扳手

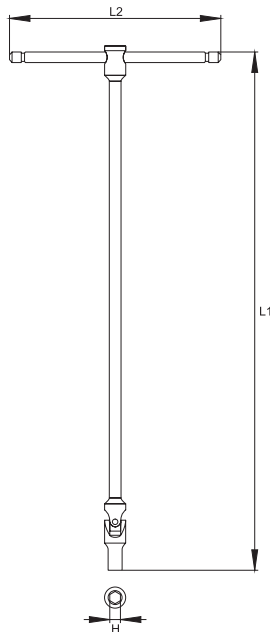

COLOR
CARDBOARD

YATO	Ø H	L1 (mm)	L2 (mm)	
YT-15271	6 mm	450	180	10/40
YT-15272	7 mm	450	180	10/40
YT-15273	8 mm	450	180	10/40
YT-15274	9 mm	450	180	10/40
YT-15275	10 mm	450	180	10/40
YT-15276	11 mm	450	180	10/40
YT-15277	12 mm	450	180	10/40
YT-15278	13 mm	450	180	10/40
YT-15279	14 mm	450	180	10/40
YT-15280	15 mm	450	180	10/40
YT-15281	16 mm	450	180	10/40
YT-15282	17 mm	450	180	10/40
YT-15283	18 mm	450	180	10/40
YT-15284	19 mm	450	180	10/40

- GB** T-type deep socket wrench
D Steckschlüssel vom Typ „T”
PL Klucz nasadowy typu „T”
RUS Торцовый ключ типа „T”
CZ Klíč nástrčný typ „T”
H „T” típusú dugókulcs

- RO** Cheie tubulară de tip „T”
F Clé à tube en „T”
I Chiave a bussola tipo „T”
E Llave tubular „T”
CN T型套筒扳手

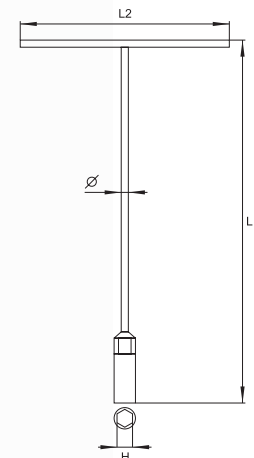

COLOR
CARDBOARD



YATO	Ø H	L1 (mm)	L2 (mm)	Ø (mm)	
YT-1571	8 mm	310	200	10	10/40
YT-1573	10 mm	310	200	10	10/40
YT-1574	11 mm	310	200	10	10/40
YT-1575	12 mm	310	200	10	10/40
YT-1576	13 mm	310	200	10	10/40
YT-1577	14 mm	310	200	10	10/40
YT-1578	15 mm	310	200	10	10/40

- GB** T-handle swivel adapter
D T-Griff Steckchlüssel mit Gelenk
PL Klucz z przegubem typu „T”
RUS Вороток Т-образный с карданом
CZ „T” klíč sa kloubem
H Csuklós T-hajtószer
RO Adaptor tip „T” cu cruce cardanica

- F** Clé à poignée en „T” longue a cardan
I Chiave a „T” con snodo
E Alargadera a cardan
CN 滑杆方向T型接头

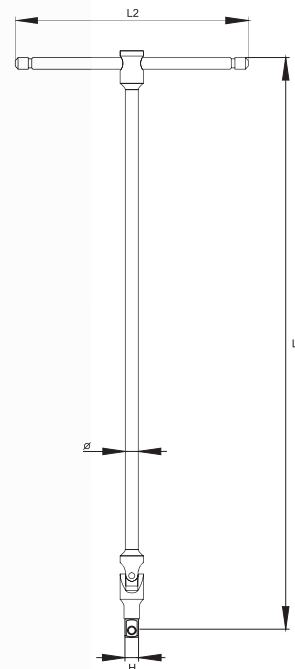

COLOR
CARDBOARD



YATO	Ø H	L1 (mm)	L2 (mm)	
YT-15291	1/4" (6.3 mm)	450	180	10/40
YT-15292	3/8" (9.5 mm)	450	180	10/40
YT-15293	1/2" (12.7 mm)	450	180	10/40

1

GB Adjustable wrench
D Rollgabelschlüssel
PL Klucz nastawny

RUS Ключ разводной
CZ Nastavitelný klíč
H Állítható svédkulcs

RO Cheie reglabilă
F Clé à molette
I Chiave a rullino graduata

E Llave ajustable tipo inglesa
CN 活络扳手

HALF DOUBLE BLISTER



150 mm 200 mm 250 mm 300 mm 375 mm

150 mm 200 mm 250 mm 300 mm DIN 3117 CrV

YATO	L (mm)	
YT-2071	150	6/60
YT-2072	200	6/60
YT-2073	250	6/36
YT-2074	300	6/24
YT-2075	375	6/12

YATO	L (mm)	
YT-2165	150	6/120
YT-2166	200	6/60
YT-2167	250	6/36
YT-2168	300	6/24



150 mm 200 mm 250 mm 300 mm DIN 3117 CrV

150 mm 200 mm 250 mm 300 mm 375 mm DIN 3117 DROP FORGED KUTE

YATO	L (mm)	
YT-2170	150	6/72
YT-2171	200	6/60
YT-2172	250	6/48
YT-2173	300	6/36

YATO	L (mm)	opening capacity (mm) zakres rozwarcia szczek (mm)	
YT-21650	150	19.3	6/60
YT-21651	200	24.0	6/60
YT-21652	250	30.0	6/36
YT-21653	300	36.0	6/24
YT-21654	375	45.0	2/16

GB Insulated adjustable wrench
D Rollgabelschlüssel isoliert
PL Klucz nastawny izolowany
RUS Ключ разводной изолированный

CZ Izolovaný staviteľný kľúč
H Állítható svédkulcs
RO Cheie reglabilă izolată
F Clé à molette isolée

I Isolati chiave regolabile
E Llaves ajustables aislantes
CN 绝缘活络扳手

POLYBAG



200 mm 250 mm 300 mm
CrV 1000 V



1000V
VDE CERTIFICATE
EN 60900:2012

YATO	L (mm)	
YT-20940	200	6/48
YT-20941	250	6/36
YT-20942	300	4/24

GB Flexible hook wrench
D Hakenschlüssel
PL Klucz hakowy
RUS Ключ сегментный шарнирный

CZ Hákový kľúč
H Kõrmõs kulcs
RO Cheie universală cu carlig
F Clé à crochet

I Chiave a settole
E Llaves de gancho articulada
CN 方头钩型扳手

CrV



YATO	L (mm)	opening capacity (mm) zakres rozwarcia szczek (mm)	
YT-01670	170	15-35	10/50
YT-01671	210	35-50	10/50
YT-01672	280	50-80	10/50
YT-01673	340	80-120	5/10
YT-01674	470	120-180	5/10

YATO	L (mm)	opening capacity (mm) zakres rozwarcia szczek (mm)	
YT-01675	170	15-35	10/50
YT-01676	210	35-50	10/50
YT-01677	280	50-80	10/50
YT-01678	340	80-120	5/10
YT-01679	470	120-180	5/10



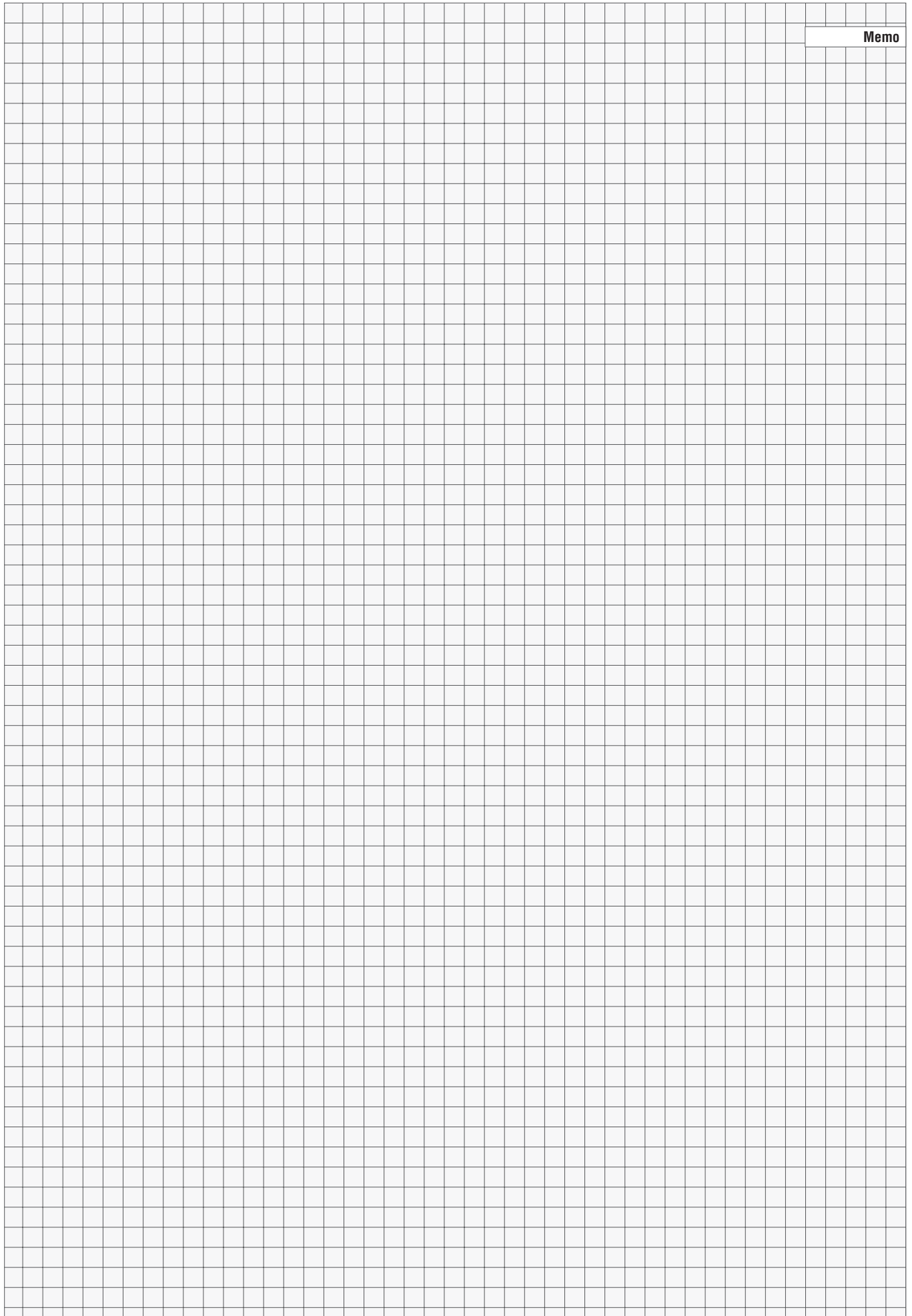







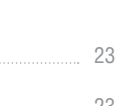



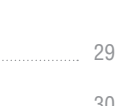
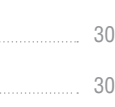

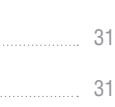
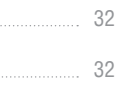

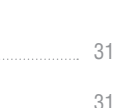
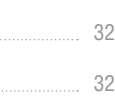
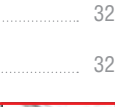

Memo

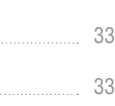
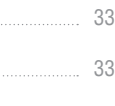

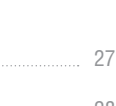

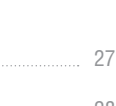

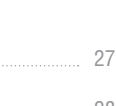





2

Sockets, accessories & sets
Klucze nasadowe,
akcesoria i zestawy



Sockets 1/4"			23	Extension bars with wobble	28
Klucze nasadowe 1/4"				Przedłużki uchylnie	
Hexagonal sockets			23	Adapters	28
Klucze nasadowe sześciokątne, krótkie				Redukcje	
Hexagonal deep sockets			23	Bit adapters	28
Klucze nasadowe sześciokątne, długie				Adaptory do bitów	
Accessories 1/4"			23-24	Universal joints	28
Akcesoria 1/4"				Przeguby Cardana	
Extension bars			29-31	Sliding T-bars	28
Przedłużki				Pokręta typu „T”	
Extension bars with wobble			29	Flexible handles	29
Przedłużki uchylnie				Pokręta łamane	
Flexible extension cords			24	Spark plug sockets	29
Przedłużki elastyczne				Klucze nasadowe do świec	
Adapters			24	Ratchet handles 3/8"	31
Redukcje				Grzechotki 3/8"	
Bit adapters			24	Ratchet handles	30
Adaptory do bitów				Grzechotki	
Universal joints			24	Flexible ratchet handles	30
Przeguby Cardana				Grzechotki z przegubem	
Spinner handles			24	Composite ratchet handles	30
Pokręta do nasadek				Grzechotki powlekane	
Sliding T-bars			24	Insulated ratchet handles	30
Pokręta typu „T”				Grzechotki izolowane	
Flexible handles			24	Curved ratchet handles	30
Pokręta łamane				Grzechotki wygięte	
Ratchet handles 1/4"			25-26	Telescopic ratchet handles	31
Grzechotki 1/4"				Grzechotki z przedłużonym uchwytem	
Ratchet handles			31-32	Sockets 1/2"	32
Grzechotki				Klucze nasadowe 1/2"	
Flexible ratchet handles			25	Hexagonal sockets	31
Grzechotki z przegubem				Klucze nasadowe sześciokątne, krótkie	
Composite ratchet handles			25	Insulated hexagonal sockets	31
Grzechotki powlekane				Klucze nasadowe sześciokątne izolowane, krótkie	
Curved ratchet handles			26	Bi-hexagonal sockets	32
Grzechotki wygięte				Klucze nasadowe dwunastokątne, krótkie	
Telescopic ratchet handles			26	Spline sockets	32
Grzechotki z przedłużonym uchwytem				Klucze nasadowe „Spline”	
Bit and socket drive ratchet handles			26	Hexagonal deep sockets	32
Grzechotki do bitów i nasadek				Klucze nasadowe sześciokątne, długie	
Rotary head ratchet handles			26	Bi-hexagonal deep sockets	32
Grzechotki z obrotową głowicą				Klucze nasadowe dwunastokątne, długie	
Sockets 3/8"			27	Accessories 1/2"	33-34
Klucze nasadowe 3/8"				Akcesoria 1/2"	
Hexagonal sockets			27	Extension bars	33
Klucze nasadowe sześciokątne, krótkie				Przedłużki	
Insulated hexagonal sockets			27	Insulated extension bars	33
Klucze nasadowe sześciokątne izolowane, krótkie				Przedłużki izolowane	
Hexagonal deep sockets			27	Extension bars with wobble	33
Klucze nasadowe sześciokątne, długie				Przedłużki uchylnie	
Accessories 3/8"			27-29	Adapters	33
Akcesoria 3/8"				Redukcje	
Extension bars			27	Bit adapters	33
Przedłużki				Adaptory do bitów	
Insulated extension bars			28	Universal joints	34
Przedłużki izolowane				Przeguby Cardana	
Sliding T-bars			34	Sliding T-bars	34
Pokręta typu „T”				Pokręta typu „T”	
Flexible handles			34	Flexible handles	34
Pokręta łamane				Pokręta łamane	
L-type handles			34	L-type handles	34
Pokręta typu „L”				Pokręta typu „L”	
Spark plug sockets			34	Spark plug sockets	34
Klucze nasadowe do świec				Klucze nasadowe do świec	



<p>Ratchet handles 1/2" Grzechotki 1/2"</p> <p style="text-align: right;">35-36 </p>	<p>Torx sockets & sets Klucze nasadowe „Torx” i zestawy</p> <p style="text-align: right;">52 </p>
<p>Ratchet handles Grzechotki..... 35</p> <p>Flexible ratchet handles Grzechotki z przegubem..... 35</p> <p>Composite ratchet handles Grzechotki powlekane..... 35</p> <p>Insulated ratchet handles Grzechotki izolowane..... 35</p> <p>Curved ratchet handles Grzechotki wygięte..... 36</p> <p>Telescopic ratchet handles Grzechotki z przedłużonym uchwytem..... 36</p> <p>Rotary head ratchet handles Grzechotki z obrotową głowicą..... 36</p> <p>Step wrenches Klucze sztorcowe..... 36</p>	<p>Go-trough socket sets 1/2" Zestawy kluczy nasadowych, przelotowych 1/2"</p> <p style="text-align: right;">52 </p> <p>Sockets 3/4" Klucze nasadowe 3/4"</p> <p style="text-align: right;">53 </p> <p>Accessories 3/4" Akcesoria 3/4"</p> <p style="text-align: right;">53-54 </p>
<p>Socket sets Zestawy kluczy nasadowych</p> <p style="text-align: right;">37-48 </p> <p>Socket sets 1/4" Zestawy kluczy nasadowych 1/4"..... 37</p> <p>Socket sets 3/8" Zestawy kluczy nasadowych 3/8"..... 39</p> <p>Socket sets 1/2" Zestawy kluczy nasadowych 1/2"..... 39</p> <p>Socket sets 1/2", 1/4" Zestawy kluczy nasadowych 1/2", 1/4"..... 40</p> <p>Socket sets 1/2", 3/8", 1/4" Zestawy kluczy nasadowych 1/2", 3/8", 1/4"..... 44</p>	<p>Extension bars Przedłużki..... 53</p> <p>Adapters Redukcje..... 53</p> <p>Universal joints Przeguby Cardana..... 53</p> <p>Sliding T-bars Pokręta typu „T”..... 53</p> <p>Flexible handles Pokręta łamane..... 54</p> <p>L-type handles Pokręta typu „L”..... 54</p> <p>Ratchet handles 3/4" Grzechotki 3/4"</p> <p style="text-align: right;">54 </p>
<p>Socket sets Zestawy kluczy nasadowych</p> <p style="text-align: right;">49-50 </p> <p>Socket sets 1/4" Zestawy kluczy nasadowych 1/4"..... 49</p> <p>Socket sets 3/8" Zestawy kluczy nasadowych 3/8"..... 49</p> <p>Socket sets 1/2" Zestawy kluczy nasadowych 1/2"..... 49</p> <p>Socket sets 1/2", 1/4" Zestawy kluczy nasadowych 1/2", 1/4"..... 50</p>	<p>Socket sets 3/4" Zestawy kluczy nasadowych 3/4"</p> <p style="text-align: right;">54 </p> <p>Bit sockets & sets 1/4", 3/8", 1/2" Klucze trzpieniowe i zestawy 1/4", 3/8", 1/2"</p> <p style="text-align: right;">55-57 </p>
<p>Tool sets Zestawy narzędziowe</p> <p style="text-align: right;">51 </p>	

GB Hexagonal socket
D Sechskantenschlüssel
PL Nasadka sześciokątna
RUS Головка шестигранная короткая
CZ Šestihřanný nástavec
H Hatszögű rátét
RO Cheie tubulară hexagonală
F Douille courte
I Chiave a bussola esagonale
E Boquilla hexagonal corta
CN 六角套筒

INCREASED CONTACT AREA

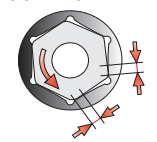

1/4"
6.3mm
DIN 3121
CrV 50BV30
AS-DRIVE

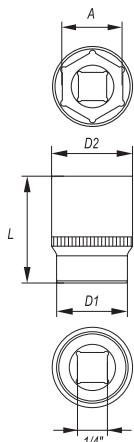

- drive locks
- surface finish: chromed, satin / mirror
- zamki blokujące
- wykończenie powierzchni: chromowana, satynowa / polerowana

COLOR BOX



YATO	Ø A (mm)	D1 (mm)	D2 (mm)	L (mm)	PCS packing	
YT-1401	4.0	7.0	12.0	25	24	240/480
YT-1403	5.0	8.0	12.0	25	24	240/480
YT-1404	5.5	8.5	12.0	25	24	240/480
YT-1405	6.0	9.0	12.0	25	24	240/480
YT-1406	7.0	10.0	12.0	25	24	240/480
YT-1407	8.0	12.0	11.0	25	24	240/480
YT-1408	9.0	13.0	12.0	25	24	240/480
YT-1409	10.0	15.0	12.0	25	24	240/480
YT-1410	11.0	16.0	14.0	25	24	240/480
YT-1411	12.0	17.0	15.0	25	24	240/480
YT-1412	13.0	18.0	16.0	25	24	240/480

GB Extension bar
D Verlängerung
PL Przedłużka
RUS Удлинитель для воротка
CZ Prodlužovací přípravek
H Toldalék
RO Prelungitor
F Rallonge
I Prolunga
E Tubo de prolongación
CN 接杆

1/4"
6.3mm
DIN 3121
CrV 50BV30

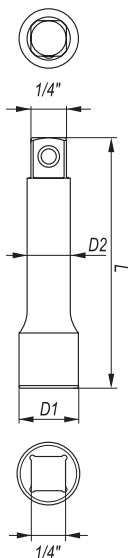

YATO	Ø	D1 (mm)	D2 (mm)	L (mm)	PCS packing	
YT-1429	1/4" (6.3 mm)	12.4	8.3	50.8	30	150/300
YT-1430	1/4" (6.3 mm)	12.4	8.3	76.0	30	150/300
YT-1431	1/4" (6.3 mm)	12.4	8.3	101.6	20	100/200
YT-1432	1/4" (6.3 mm)	12.4	8.3	152.4	20	100/200

COLOR BOX



GB Hexagonal deep socket
D Sechskantenschlüssel, lange
PL Nasadka sześciokątna długa
RUS Головка шестигранная длинная
CZ Šestihřanný hluboký nástavec
H Hatszögű rátét mély
RO Cheie tubulară hexagonală adâncă
F Douille longue
I Chiave a bussola esagonale
E Boquilla hexagonal larga
CN 六角长套筒

INCREASED CONTACT AREA

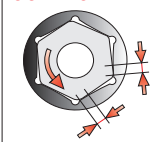

1/4"
6.3mm
DIN 3121
CrV 50BV30
AS-DRIVE

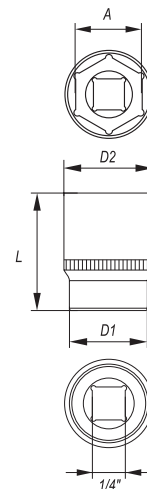

- drive locks
- surface finish: chromed, satin / mirror
- zamki blokujące
- wykończenie powierzchni: chromowana, satynowa / polerowana

COLOR BOX



YATO	Ø A (mm)	D1 (mm)	D2 (mm)	L (mm)	PCS packing	
YT-1413	4.0	7.0	12.0	50	24	240/480
YT-1414	4.5	7.5	12.0	50	24	240/480
YT-1415	5.0	8.0	12.0	50	24	240/480
YT-1416	5.5	8.5	12.0	50	24	240/480
YT-1417	6.0	9.0	12.0	50	24	240/480
YT-1418	7.0	10.0	12.0	50	24	240/480
YT-1419	8.0	12.0	12.0	50	24	240/480
YT-1420	9.0	13.0	12.0	50	24	240/480
YT-1421	10.0	14.0	13.0	50	24	240/480
YT-1422	11.0	16.0	14.0	50	24	120/240
YT-1423	12.0	17.0	15.0	50	24	120/240
YT-1424	13.0	18.0	16.0	50	24	120/240

GB Extension bar with wobble
D Gelenkverlängerung
PL Przedłużka uchylna
RUS Удлинитель наклонный
CZ Odchylný prodlužovací přípravek
H Csuklós toldalék
RO Prelungitor rabatabil
F Rallonge angulaire
I Prolunga
E Tubo de prolongación desviable
CN 转向接杆

1/4"
6.3mm
DIN 3121
CrV 50BV30

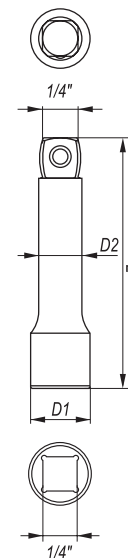

YATO	Ø	D1 (mm)	D2 (mm)	L (mm)	PCS packing	
YT-1433	1/4" (6.3 mm)	12.4	8.3	50.8	30	150/300
YT-1434	1/4" (6.3 mm)	12.4	8.3	76.0	30	150/300
YT-1435	1/4" (6.3 mm)	12.4	8.3	101.6	20	100/200
YT-1436	1/4" (6.3 mm)	12.4	8.3	152.4	20	100/200

COLOR BOX



GB Extension bar
D Verlängerung
PL Przedłużka elastyczna
RUS Удлинитель для воротка

CZ Prodlužovací přípravek
H Toldalék
RO Prelungitor
F Rallonge élastique

I Prolunga flessibile
E Tubo de prolongación
CN 可弯式接杆

1/4"
6.3mm
CrV
6140

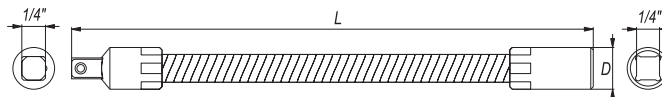

YATO	Ø	Ø	D (mm)	L (mm)	PCS packing	Box
YT-1400	1/4" (6.3 mm)	1/4" (6.3 mm)	11.6	150	25	250/500

GB Adapter
D Reduktion
PL Redukcja
RUS Переходник
CZ Redukce
RO Redució
H Reducție
F Réduction
I Riduttore
E Reducción
CN 转换头

1/4"
6.3mm
DIN
3121
CrV
50BV30

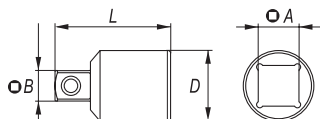

YATO	Ø A	Ø B	D (mm)	L (mm)	PCS packing	Box
YT-1438	1/4" (6.3 mm) (F)	3/8" (9.5 mm) (M)	12	25	10	250/500

GB Bit adapter
D Bithalter
PL Adapter do bitów
RUS Держатель винтовёртовых наконечников
CZ Držák na šroubovakové koncovky
H Szár a csavarhúzóvégekhez
RO Capete șurubelniță
F Adapteur d'embouts
I Chiave esagonale a bussola
E Mandril para puntas
CN 旋具头接头

1/4"
6.3mm
CrV
6140

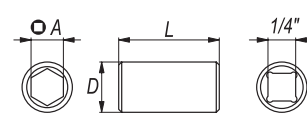

YATO	Ø	Ø A	D (mm)	L (mm)	PCS packing	Box
YT-1297	1/4" (6.3 mm)	1/4" (6.3 mm)	11.8	24	10	250/500

GB Universal joint
D Kardangelen
PL Przegub Cardana
RUS Карданный шарнир
CZ Kardanový kloub
H Kárdán csukló

RO Articulație Cardanică
F Cardan
I Snodo cardanico
E Articulación Cardan
CN 万向接头

1/4"
6.3mm
DIN
3121
CrV
50BV30

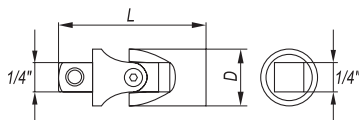

COLOR BOX



YATO	Ø	D (mm)	L (mm)	PCS packing	Box
YT-1437	1/4" (6.3 mm)	14	35	20	120/240

GB Spinner handle
D Drehgriff für steckschlüssel
PL Pokrętko do nasadek
RUS Ручка с соединением под головки
CZ Nástavec ruční na bity
H Csavarhúzó hajtószar

RO Prelungitor antrenor pt. biti
F Barre
I Porta bussola con manico
E Destornillador con cuadrillo
CN 旋柄

1/4"
6.3mm
CrV
50BV30



COLOR BOX



YATO	Ø	L (mm)	PCS packing	Box
YT-1427	1/4" (6.3 mm)	150	12	48

GB Sliding T-bar
D Handgriff mit Gleitstück
PL Pokrętko typu „T”
RUS Вороток T-образный
CZ Otočná račka typ „T”

H „T” alakú hajtókar
RO Mâner clupă tipul „T”
F Barre type „T”
I Manopola „T” scorrevole
E Mango tipo „T”
CN 滑行杆

1/4"
6.3mm
DIN
3121
CrV
50BV30

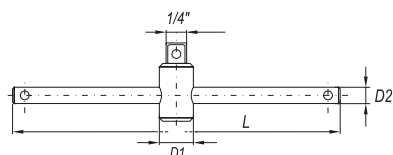

COLOR BOX

YATO	Ø	D1 (mm)	D2 (mm)	L (mm)	PCS packing	Box
YT-1426	1/4" (6.3 mm)	13.3	6.3	152.4	10	100/200

GB Flexible handle
D Gelenkgriff
PL Pokrętko lamane
RUS Вороток шарнирный
CZ Otočná lomená ráčka
H Hajlított hajtókar

RO Prelungitor cu prindere flexibilă
F Barre pivotante
I Manopola a snodo
E Mango articulado
CN 转向手柄

1/4"
6.3mm
DIN
3121
CrV
50BV30

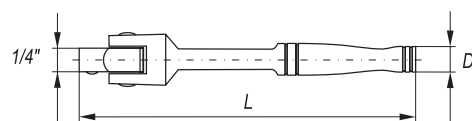

COLOR BOX

YATO	Ø	D (mm)	L (mm)	PCS packing	Box
YT-1425	1/4" (6.3 mm)	13	140	10	100/200

GB Quick release ratchet handle
D Hebelumschaltknarre
PL Grzechotka
RUS Трещотка
CZ Řehťačka
H Racsnis hajtókár

RO Dispozitiv de prindere cu clichet
F Clé à cliquet
I Cricchetto bussola
E Carraca
CN 快速脱落棘轮扳手

PLASTIC HANGER



12 PCS



COLOR BOX

1/4"
6.3mm

DIN
3122

QUICK
RELEASE
SZYBKO-
ZŁĄCZE

72T

CrV
6140



YATO	Ø	T	L (mm)	PCS packing:	Box
YT-0307	1/4" (6.3 mm)	72	146	12	24/96

YATO	Ø	T	L (mm)	PCS packing:	Box
YT-0310	1/4" (6.3 mm)	72	125	12	36/72

YATO	Ø	T	L (mm)	PCS packing:	Box
YT-0313	1/4" (6.3 mm)	72	125	12	24/96



YATO	Ø	T	L (mm)	PCS packing:	Box
YT-0316	1/4" (6.3 mm)	72	145	12	24/96

YATO	Ø	T	L (mm)	PCS packing:	Box
YT-0319	1/4" (6.3 mm)	72	145	12	48/96

YATO	Ø	T	L (mm)	PCS packing:	Box
YT-0322	1/4" (6.3 mm)	72	148	12	48/96

GB Quick release ratchet handle
D Hebelumschaltknarre
PL Grzechotka
RUS Трещотка
CZ Řehťačka
H Racsnis hajtókár

RO Dispozitiv de prindere cu clichet
F Clé à cliquet
I Cricchetto bussola
E Carraca
CN 快速脱落棘轮扳手

PLASTIC HANGER



12 PCS



COLOR BOX

1/4"
6.3mm

DIN
3122

QUICK
RELEASE
SZYBKO-
ZŁĄCZE

72T

CrV
6140

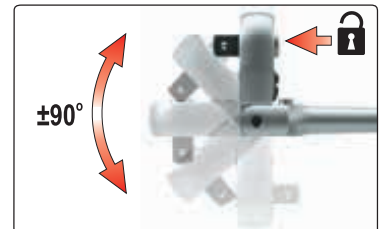

YATO	Ø	T	L (mm)	PCS packing:	Box
YT-0325	1/4" (6.3 mm)	72	159	12	48/96

GB Quick release ratchet handle
D Hebelumschaltknarre
PL Grzechotka powlekana
RUS Трещотка
CZ Řehťačka
H Racsnis hajtókár

RO Dispozitiv de prindere cu clichet
F Clé à cliquet
I Cricchetto bussola
E Carraca
CN 快速脱落棘轮扳手

PLASTIC HANGER



12 PCS



COLOR BOX

1/4"
6.3mm

DIN
3122

QUICK
RELEASE
SZYBKO-
ZŁĄCZE

72T

CrV
6135



YATO	Ø	T	L (mm)	PCS packing:	Box
YT-0290	1/4" (6.3 mm)	72	144	12	48/96

YATO	Ø	T	L (mm)	PCS packing:	Box
YT-0293	1/4" (6.3 mm)	72	144	12	48/96

- GB** Quick release ratchet handle
D Hebelumschaltknarre
PL Grzechotka
RUS Трещотка
CZ Řehtačka
H Racsnis hajtókar
RO Dispozitiv de prindere cu clichet
F Clé à cliquet
I Cricchetto bussola
E Carraca
CN 快速脱落棘轮扳手

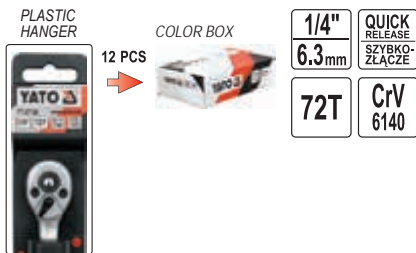

1/4"	QUICK RELEASE SZYBKO-ZŁĄCZE
6.3mm	CrV 6140
72T	

- GB** Quick release ratchet handle
D Hebelumschaltknarre
PL Grzechotka
RUS Трещотка
CZ Řehtačka
H Racsnis hajtókar
RO Dispozitiv de prindere cu clichet
F Clé à cliquet
I Cricchetto bussola
E Carraca
CN 快速脱落棘轮扳手

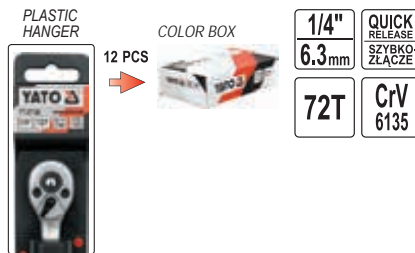

1/4"	QUICK RELEASE SZYBKO-ZŁĄCZE
6.3mm	CrV 6135
72T	



YATO	Ø	T	L (mm)	PCS packing	
YT-0730	1/4" (6.3 mm)	72	155	12	24/96



YATO	Ø	T	L (mm)	PCS packing	
YT-0733	1/4" (6.3 mm)	72	155	12	24/96

- GB** Telescopic ratchet handle
D Umschaltknarre
PL Grzechotka z przedłużanym uchwytem
RUS Трещотка
CZ Řehtačka
H Racsnis hajtókar
RO Antrenor cu clichet
F Clé à cliquet
I Cricchetto bussola
E Carraca telescópico
CN 可伸缩快速脱落棘轮扳手

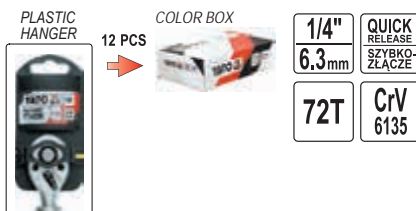

1/4"	QUICK RELEASE SZYBKO-ZŁĄCZE
6.3mm	CrV 6135
72T	

- GB** Ratchet handle and bit drive
D Bit- und Steckschlüssel-Umschaltknarre
PL Grzechotka do bitów i nasadek
RUS Трещотка для битов и головок
CZ Ráčna kombinovaná pro bity a nástřné kľíče
H Bit és dugófej behajtó racsnis hajtókar
RO Antrenor cu clichet / antrenor pt. biti
F Clé à cliquet
I Cricchetto bussola per punte e snodi
E Carraca para boquillas y puntas
CN 套筒旋具两用棘轮扳手

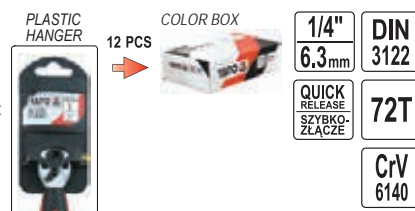

1/4"	DIN 3122
6.3mm	72T
	CrV 6140



YATO	Ø	T	L (mm)	PCS packing	
YT-0297	1/4" (6.3 mm)	72	150-200	12	48



YATO	Ø	T	L (mm)	PCS packing	
YT-0331	1/4" (6.3 mm)	72	136	12	48

- GB** Swivel ratchet handle for bits and sockets
D Umschaltknarre mit Außenvierkanttrieb
PL Grzechotka z obrotową głowicą do bitów i nasadek
RUS Трещетка реверсивная
CZ Ráčna s otočnou hlavou
H Forgófejes racsnis szár
RO Antrenor cu clichet flexibil
F Clé à cliquet tête pivotante
I Cricchetto bussola per punte e snodi
E Carraca con cabeza giratoria
CN 旋轉頭套筒旋具兩用棘輪扳手

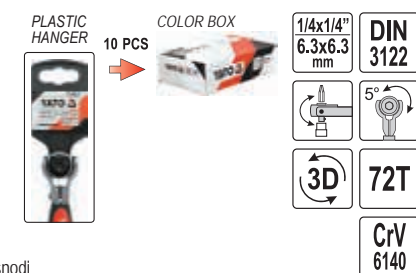

1/4x1/4"	DIN 3122
6.3x6.3 mm	72T
5°	CrV 6140
3D	

- GB** Flexible ratchet handle / round head
D Flexible Drehkopfratsche
PL Grzechotka z obrotową głowicą
RUS Трещетка с вращательной головкой
CZ Ráčna s otočnou hlavou
H Forgófejes racsnis szár
RO Antrenor cu clichet flexibil
F Clé à cliquet tête pivotante
I Cricchetto bussola reversibile con ghiera
E Carraca con cabeza giratoria
CN 旋轉頭快速脱落棘轮扳手

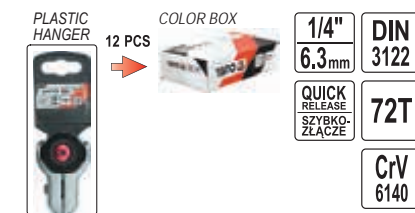

1/4"	DIN 3122
6.3mm	72T
	CrV 6140



YATO	Ø	T	L (mm)	PCS packing	
YT-03311	1/4" (6.3 mm) x 1/4" (6.3 mm)	72	115	10	100



YATO	Ø	T	L (mm)	PCS packing	
YT-0720	1/4" (6.3 mm)	72	145	12	24/96

- GB** Hexagonal socket
D Sechskantenschlüssel
PL Nasadka sześciokątna
RUS Головка шестигранная короткая
CZ Šestihřanný nástavec
H Hatszögű rátét
RO Cheie tubulară hexagonală
F Douille courte
I Chiave a bussola esagonale
E Boquilla hexagonal corta
CN 六角套筒

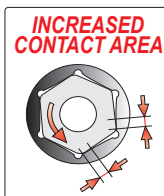
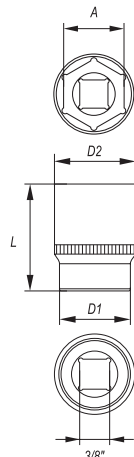

3/8" 10mm
 DIN 3121
 CrV 50BV30
 AS-DRIVE

- drive locks
- surface finish: chromed, satin / mirror

- zamki blokujące
- wykończenie powierzchni: chromowana, satynowa / polerowana



YATO	∅ A (mm)	D1 (mm)	D2 (mm)	L (mm)	PCS packing	
YT-3801	6	10	17	28	24	240/480
YT-3802	7	11	17	28	24	240/480
YT-3803	8	12	17	28	24	240/480
YT-3804	9	13	17	28	24	240/480
YT-3805	10	14	17	28	24	240/480
YT-3806	11	16	17	28	24	240/480
YT-3807	12	18	17	28	24	240/480
YT-3808	13	19	18	28	24	240/480
YT-3809	14	20	19	28	24	240/480
YT-3810	15	21	19	28	24	240/480
YT-3811	16	22	21	28	24	240/480
YT-3812	17	24	22	30	12	120/240
YT-3813	18	25	23	30	12	120/240
YT-3814	19	26	24	30	12	120/240

- GB** Hexagonal deep socket
D Sechskantenschlüssel, lange
PL Nasadka sześciokątna długa
RUS Головка шестигранная длинная
CZ Šestihřanný hluboký nástavec
H Hatszögű rátét mély
RO Cheie tubulară hexagonală adâncă
F Douille longue
I Chiave a bussola esagonale
E Boquilla hexagonal larga
CN 六角长套筒

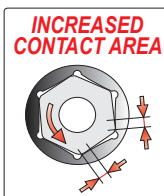
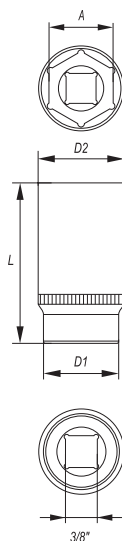

3/8" 10mm
 DIN 3121
 CrV 50BV30
 AS-DRIVE

- drive locks
- surface finish: chromed, satin / mirror

- zamki blokujące
- wykończenie powierzchni: chromowana, satynowa / polerowana



YATO	∅ A (mm)	D1 (mm)	D2 (mm)	L (mm)	PCS packing	
YT-3820	6	10	17	63	24	48/96
YT-3821	7	10	17	63	24	48/96
YT-3822	8	12	17	63	24	48/96
YT-3823	9	13	17	63	24	48/96
YT-3824	10	14	17	63	24	48/96
YT-3825	11	16	17	63	24	48/96
YT-3826	12	18	17	63	24	48/96
YT-3827	13	19	17	63	24	48/96
YT-3828	14	20	19	63	24	48/96
YT-3829	15	21	19	63	12	60/120
YT-3830	16	22	20	63	12	60/120
YT-3831	17	24	23	63	12	60/120
YT-3832	18	25	23	63	12	60/120
YT-3833	19	26	24	63	12	60/120

- GB** Insulated hexagonal socket
D Sechskantenschlüssel vollisoliert
PL Nasadka sześciokątna izolowana
RUS Головка шестигранная короткая изолированная
CZ Šestihřanný nástavec, izolovaný
H Hatszögű rátét
RO Cheie tubulară hexagonală izolată
F Douille courte isolée
I Chiave a bussola esagonale isolato
E Boquilla hexagonal corta aislante
CN 绝缘六角套筒

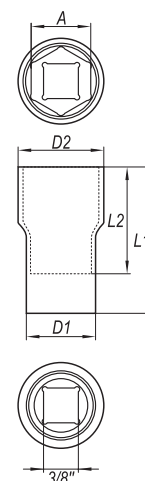

3/8" 10mm
 CrV
 1000 V
 D/E

1000V
 VDE CERTIFICATE
 EN 60900:2012

POLYBAG



YATO	∅ A (mm)	D1 (mm)	D2 (mm)	L1 (mm)	L2 (mm)	
YT-21008	8	18	15.1	45	28	7/126
YT-21010	10	18	18.7	45	28	7/126
YT-21011	11	18	20.0	45	28	7/126
YT-21012	12	18	21.2	45	28	7/126
YT-21013	13	18	22.5	45	28	7/126
YT-21014	14	18	23.7	45	28	7/126
YT-21016	16	18	26.2	45	28	7/126
YT-21017	17	18	27.5	45	28	7/126
YT-21018	18	18	28.7	45	30	5/90
YT-21019	19	18	30.0	47	30	5/90
YT-21021	21	18	32.6	47	30	5/90
YT-21022	22	18	33.7	47	30	5/90

- GB** Extension bar
D Verlängerung
PL Przedłużka
RUS Удлинитель для воротка
CZ Prodlužovací příravek
H Toldalék
RO Prelungitor
F Rallonge
I Prolunga
E Tubo de prolongación
CN 接杆

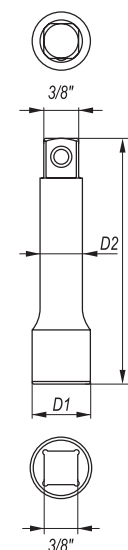

3/8" 10mm

DIN 3121

CrV 50BV30

- drive locks
- surface finish: chromed, satin / mirror

- zamki blokujące
- wykończenie powierzchni: chromowana, satynowa / polerowana



YATO	∅	D1 (mm)	D2 (mm)	L (mm)	PCS packing	
YT-3842	3/8" (9.5 mm)	18.0	12.3	42.0	10	100/200
YT-3843	3/8" (9.5 mm)	18.0	12.3	76.0	10	100/200
YT-3844	3/8" (9.5 mm)	18.0	12.3	152.4	10	50/100
YT-3845	3/8" (9.5 mm)	18.0	12.3	254.0	10	50

COLOR BOX



- GB** Insulated extension bar
D Verlängerung vollisoliert
PL Przedłużka izolowana
RUS Удлинитель для воротка
CZ Prodlužovací přípravek, izolovaný
H Toldalék
RO Prelungitor izolat
F Rallonge isolée
I Prolunga isolato
E Tubo de prolongación aislante
CN 绝缘接杆



3/8"
10mm
CrV
1000 V
DVE

POLYBAG

1000V
VDE CERTIFICATE
EN 60900:2012

YATO	Ø	D1 (mm)	D2 (mm)	L1 (mm)	L2 (mm)	PCS packing
YT-21055	3/8" (9.5 mm)	23	15.5	125	141	18/72
YT-21056	3/8" (9.5 mm)	23	15.5	250	266	12/48

- GB** Extension bar with wobble
D Gelenkverlängerung
PL Przedłużka uchylna
RUS Удлинитель наклонный
CZ Odchylný prodlužovací přípravek
H Csuklós toldalék
RO Prelungitor rabatabil
F Rallonge angulaire
I Prolunga
E Tubo de prolongación desviable
CN 转向接杆

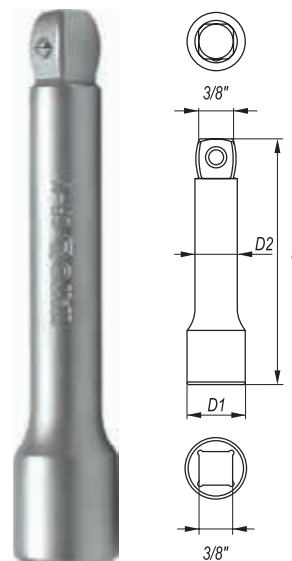

3/8"
10mm
DIN 3121
CrV 50BV30

COLOR BOX

YATO	Ø	D1 (mm)	D2 (mm)	L (mm)	PCS packing
YT-3847	3/8" (9.5 mm)	18.0	12.3	76.0	10 100/200
YT-3848	3/8" (9.5 mm)	18.0	12.3	152.4	10 50/100
YT-3849	3/8" (9.5 mm)	18.0	12.3	254.0	10 50

- GB** Adapter
D Reduktion
PL Redukcja
RUS Переходник
CZ Redukce
H Redukció
RO Reducție
F Réduction
I Riduttore
E Reducción
CN 转换头

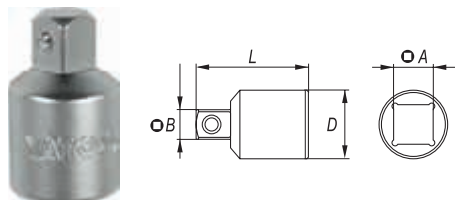

3/8"
10mm
DIN 3121
CrV 50BV30

COLOR BOX

YATO	Ø A	Ø B	D (mm)	L (mm)	PCS packing
YT-3853	3/8" (9.5 mm) (F)	1/4" (6.3 mm) (M)	17	27	10 250/500
YT-3854	3/8" (9.5 mm) (F)	1/2" (12.7 mm) (M)	17	35	10 100/200

- GB** Bit adapter
D Bithalter
PL Adapter do bitów
RUS Держатель винтовёртовых наконечников
CZ Držák na šroubovavkové koncovky
H Szár a csavarhúzóvégekhez
RO Capete şurubelniţă
F Adaptateur d'embouts
I Chiave esagonale a bussola
E Mandril para puntas
CN 旋具头接头

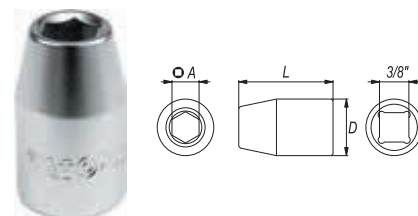

3/8"
10mm
CrV 6140

COLOR BOX

YATO	Ø	Ø A	D (mm)	L (mm)	PCS packing
YT-1296	3/8" (9.5 mm)	8 mm	17.9	30	10 250/500

- GB** Universal joint
D Kardangelen
PL Przegub Cardana
RUS Карданный шарнир
CZ Kardanový kloub
H Kardán csukló
RO Articulație Cardanică
F Cardan
I Snodo cardanico
E Articulación Cardan
CN 万向接头

3/8"
10mm
DIN 3121
CrV 50BV30

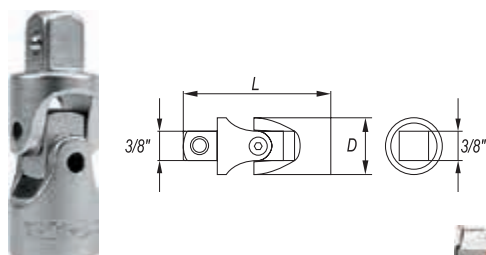

COLOR BOX

YATO	Ø	D (mm)	L (mm)	PCS packing
YT-3850	3/8" (9.5 mm)	18	49	10 50/200

- GB** Sliding T-bar
D Handgriff mit Gleistück
PL Pokrętko typu „T”
RUS Вороток Т-образный
CZ Otočná račka typ „T”
H „T” alakú hajtókar
RO Mâner clupă tipul „T”
F Barre type „T”
I Manopola „T” scorrevole
E Mango tipo „T”
CN 滑行杆

3/8"
10mm
DIN 3121
CrV 50BV30

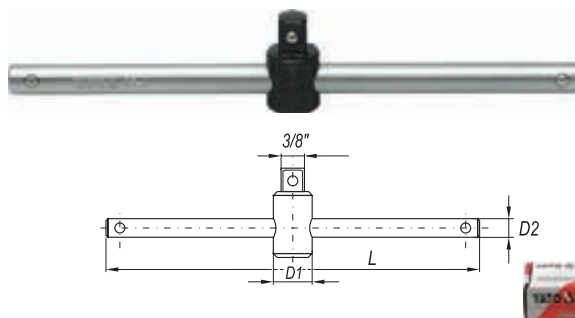

COLOR BOX

YATO	Ø	D1 (mm)	D2 (mm)	L (mm)	PCS packing
YT-3840	3/8" (9.5 mm)	20.0	10.7	198	10 50/100

GB Flexible handle
D Gelengriff
PL Pokreťto lamane

RUS Вороток шарнирный
CZ Otočná lomená rčka
H Hajlított hajtókár

RO Prelungitor
cu prindere flexibilă
F Barre pivotante

I Manopola a snodo
E Mango articulado
CN 转向手柄

3/8"
10mm
DIN
3121
CrV
50BV30

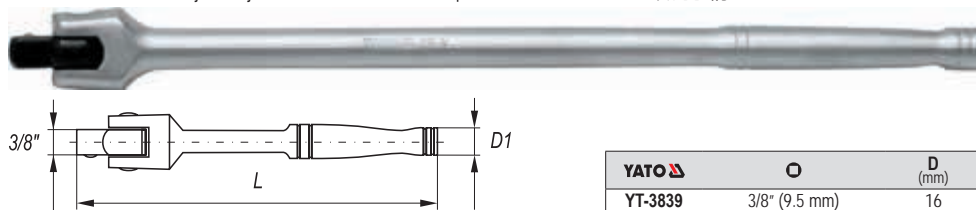

COLOR BOX

YATO	Ø	D (mm)	L (mm)	PCS packing	Box
YT-3839	3/8" (9.5 mm)	16	215	8	24/48

GB Spark plug socket
D Steckschlüssel
mit Gummihalterung
PL Nasadka do świec
RUS Головка свечная
CZ Nastavec pro svíčky

H Gyújtógyertya toldalék
RO Cheie de bujii
F Douille à bougies
I Chiavi a bussola
RUS Головка свечная
CZ 六角火花塞套筒

3/8"
10mm
DIN
3121
AS-DRIVE
CrV
50BV30

GB Spark plug socket
D Steckschlüssel
mit Gummihalterung
PL Nasadka do świec
RUS Головка свечная
CZ Nastavec pro svíčky

H Gyújtógyertya toldalék
RO Cheie de bujii
F Douille à bougies
I Chiavi a bussola
RUS Головка свечная
CZ 六角火花塞套筒

3/8"
10mm
DIN
3124
AS-DRIVE
CrV
6140

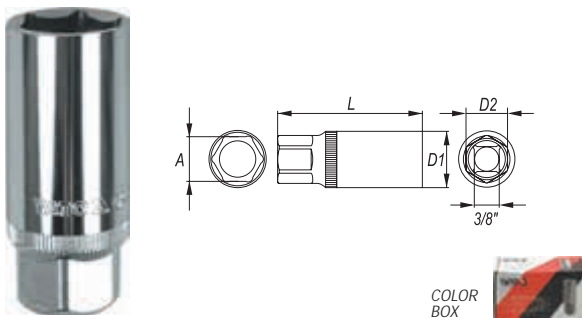

COLOR BOX

YATO	Ø	A	D1 (mm)	D2 (mm)	L (mm)	PCS packing	Box
YT-3851	3/8" (9.5 mm)	16.0	22.0	19.0	64.0	10	50/100

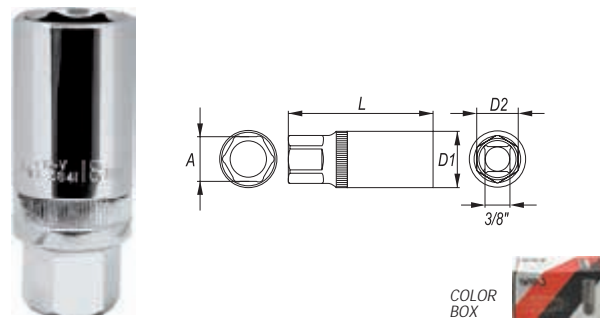

COLOR BOX

YATO	Ø	A	D1 (mm)	D2 (mm)	L (mm)	PCS packing	Box
YT-3841	3/8" (9.5 mm)	18.0	25.8	19.0	63	25	50/100

GB Spark plug socket
D Steckschlüssel
mit Gummihalterung
PL Nasadka do świec
RUS Головка свечная
CZ Nastavec pro svíčky
H Gyújtógyertya
toldalék
RO Cheie de bujii
F Douille à bougies
I Chiavi a bussola
E Boquilla de bujías
CN 六角火花塞套筒

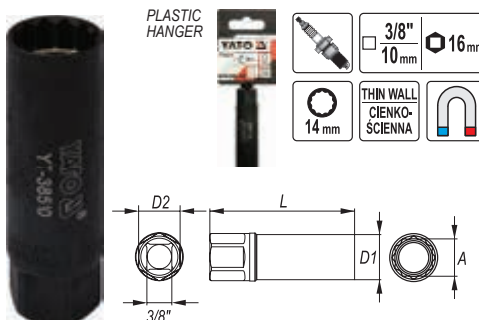

PLASTIC HANGER

3/8"
10mm
16mm
THIN WALL
CIENKO-
SCIENNA

YATO	Ø	A	D1 (mm)	D2 (mm)	L (mm)	PCS packing	Box
YT-38510	3/8" (9.5 mm)	14	18	16	63	25/100	

GB Spark plug socket
D Steckschlüssel
mit Gummihalterung
PL Nasadka do świec
RUS Головка свечная
CZ Nastavec pro svíčky
H Gyújtógyertya
toldalék
RO Cheie de bujii
F Douille à bougies
I Chiavi a bussola
E Boquilla de bujías
CN 六角火花塞套筒

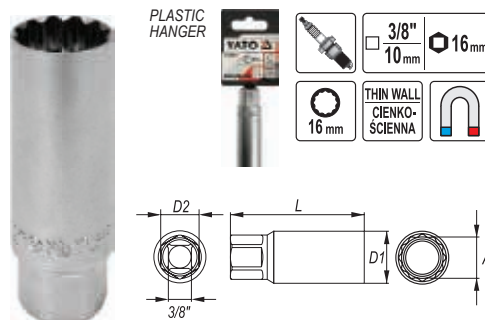

PLASTIC HANGER

3/8"
10mm
16mm
THIN WALL
CIENKO-
SCIENNA

YATO	Ø	A	D1 (mm)	D2 (mm)	L (mm)	PCS packing	Box
YT-38511	3/8" (9.5 mm)	16	20	16	62	25/100	

GB Spark plug socket
D Steckschlüssel
mit Gummihalterung
PL Nasadka do świec
RUS Головка свечная
CZ Nastavec pro svíčky
H Gyújtógyertya
toldalék
RO Cheie de bujii
F Douille à bougies
I Chiavi a bussola
E Boquilla de bujías
CN 六角火花塞套筒



PLASTIC HANGER

3/8"
10mm
14mm
THIN WALL
CIENKO-
SCIENNA

YATO	Ø	A	D1 (mm)	D2 (mm)	L (mm)	PCS packing	Box
YT-38512	3/8" (9.5 mm)	14	19	20	88	25/100	

GB Quick release ratchet handle
D Hebelumschaltknarre
PL Crzcchoťka
RUS Трещотка
CZ Řehťacka
H Racsnis hajtókár

RO Dispozitiv de prindere cu clichet
F Clé à cliquet
I Cricchetto bussola
E Carraca
CN 快速脱落棘轮扳手

PLASTIC HANGER



6 PCS



COLOR BOX

3/8"
10mm
DIN
3122
QUICK
RELEASE
SZYBKO-
ZŁĄCZCE
72T
CrV
6140



YATO	Ø	T	L (mm)	PCS packing	Box
YT-0308	3/8" (9.5 mm)	72	185	6	24/48

YATO	Ø	T	L (mm)	PCS packing	Box
YT-0311	3/8" (9.5 mm)	72	200	6	18/36

YATO	Ø	T	L (mm)	PCS packing	Box
YT-0314	3/8" (9.5 mm)	72	170	6	24/48

GB Quick release ratchet handle
D Hebelumschaltknarre
PL Grzechotka
RUS Трещотка
CZ Řehtačka
H Racsnis hajtókar

RO Dispozitiv de prindere cu clichet
F Clé à cliquet
I Cricchetto bussola
E Carraca
CN 快速脱落棘轮扳手

PLASTIC HANGER



6 PCS



COLOR BOX

3/8"
10mm

DIN
3122

QUICK
RELEASE
SZYBKO-
ZŁĄCZE

72T

CrV
6140



YATO	Ø	T	L (mm)	PCS packing	Box
YT-0317	3/8" (9.5 mm)	72	200	6	24/48

YATO	Ø	T	L (mm)	PCS packing	Box
YT-0320	3/8" (9.5 mm)	72	205	6	24/48

YATO	Ø	T	L (mm)	PCS packing	Box
YT-0323	3/8" (9.5 mm)	72	197	6	24/48

GB Quick release ratchet handle
D Hebelumschaltknarre
PL Grzechotka
RUS Трещотка

CZ Řehtačka
H Racsnis hajtókar
RO Dispozitiv de prindere cu clichet

F Clé à cliquet
I Cricchetto bussola

E Carraca
CN 快速脱落棘轮扳手

3/8"
10mm

QUICK
RELEASE
SZYBKO-
ZŁĄCZE

DIN
3122

72T

CrV
6140

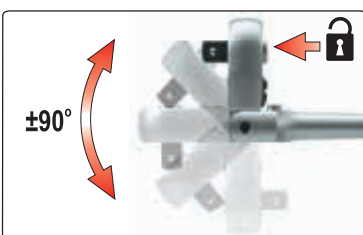

PLASTIC HANGER



6 PCS



COLOR BOX

YATO	Ø	T	L (mm)	PCS packing	Box
YT-0326	3/8" (9.5 mm)	72	242	6	24/48

GB Quick release ratchet handle
D Hebelumschaltknarre
PL Grzechotka powlekana
RUS Трещотка
CZ Řehtačka
H Racsnis hajtókar

RO Dispozitiv de prindere cu clichet
F Clé à cliquet
I Cricchetto bussola
E Carraca
CN 快速脱落棘轮扳手

PLASTIC HANGER



6 PCS



3/8"
10mm

DIN
3122

QUICK
RELEASE
SZYBKO-
ZŁĄCZE

72T

CrV
6135



YATO	Ø	T	L (mm)	PCS packing	Box
YT-0291	3/8" (9.5 mm)	72	202	6	24/48

YATO	Ø	T	L (mm)	PCS packing	Box
YT-0294	3/8" (9.5 mm)	72	202	6	24/48

GB Insulated ratchet handle
D Hebelumschaltknarre vollisoliert
PL Grzechotka izolowana
RUS Трещотка диэлектрическая
CZ Řehtačka izolovaná
H Racsnis hajtókar

RO Antrenor cu clichet izolat
F Clé à cliquet isolée
I Cricchetto bussola isolato
E Carraca aislante
CN 绝缘棘轮扳手

3/8"
10mm
CrV
1000 V
D'E

GB Quick release ratchet handle
D Hebelumschaltknarre
PL Grzechotka
RUS Трещотка
CZ Řehtačka
H Racsnis hajtókar
RO Dispozitiv de prindere cu clichet
F Clé à cliquet
I Cricchetto bussola
E Carraca
CN 快速脱落棘轮扳手

PLASTIC HANGER



6 PCS



3/8"
10mm

QUICK
RELEASE
SZYBKO-
ZŁĄCZE

72T

CrV
6140



POLYBAG



YATO	Ø	T	L (mm)	Box
YT-21071	3/8" (9.5 mm)	36	200	6/48



YATO	Ø	T	L (mm)	PCS packing	Box
YT-0731	3/8" (9.5 mm)	72	200	6	24/48

- GB** Quick release ratchet handle
D Hebelumschaltknarre
PL Grzechotka
RUS Трещотка
CZ Řehtačka
H Racsnis hajtókar
RO Dispozitiv de prindere cu clichet
F Clé à cliquet
I Cricchetto bussola
E Carraca
CN 快速脱落棘轮扳手

PLASTIC HANGER
 6 PCS
 COLOR BOX

 3/8" 10mm
 QUICK RELEASE SZYBKO-ZŁĄCZE
 72T CrV 6135



YATO	Ø	T	L (mm)	PCS packing	
YT-0734	3/8" (9.5 mm)	72	200	6	24/48

- GB** Telescopic ratchet handle
D Umschaltknarre
PL Grzechotka z przedłużonym uchwytem
RUS Трещотка
CZ Řehtačka
H Racsnis hajtókar
RO Antrenor cu clichet
F Clé à cliquet
I Cricchetto bussola
E Carraca telescópico
CN 可伸缩快速脱落棘轮扳手

PLASTIC HANGER
 6 PCS
 COLOR BOX

 3/8" 10mm
 QUICK RELEASE SZYBKO-ZŁĄCZE
 72T CrV 6135



YATO	Ø	T	L (mm)	PCS packing	
YT-0298	3/8" (9.5 mm)	72	215-315	6	24

- GB** Hexagonal socket
D Sechskantenschlüssel
PL Nasadka sześciokątna
RUS Головка шестигранная короткая
CZ Šestihránný nástavec
H Hatszögű rátét
RO Cheie tubulară hexagonală
F Douille courte
I Chiave a bussola esagonale
E Boquilla hexagonal corta
CN 六角套筒

INCREASED CONTACT AREA

 1/2" 12.5mm
 DIN 3121
 CrV 50BV30 AS-DRIVE



- drive locks
- surface finish: chromed, satin / mirror
- zamki blokujące
- wykończenie powierzchni: chromowana, satynowa / polerowana

YATO	Ø A (mm)	D1 (mm)	D2 (mm)	L (mm)	PCS packing	
YT-1201	8	12	22	38	12	120/240
YT-1202	9	14	22	38	12	120/240
YT-1203	10	15	22	38	12	120/240
YT-1204	11	16	22	38	12	120/240
YT-1205	12	18	22	38	12	120/240
YT-1206	13	19	22	38	12	120/240
YT-1207	14	20	22	38	12	120/240
YT-1208	15	21	22	38	12	120/240
YT-1209	16	23	22	38	12	120/240
YT-1210	17	24	23	38	12	120/240
YT-1211	18	25	23	38	12	120/240
YT-1212	19	27	24	38	12	120/240
YT-1213	20	28	24	38	12	120/240
YT-1214	21	29	24	38	12	120/240
YT-1215	22	30	26	38	12	120/240
YT-1216	23	31	28	38	12	60/120
YT-1217	24	32	28	38	12	60/120
YT-1218	27	36	30	42	12	60/120
YT-1219	30	40	34	42	12	60/120
YT-1220	32	42	36	42	12	24/48

- GB** Insulated hexagonal socket
D Sechskantenschlüssel vollisoliert
PL Nasadka sześciokątna izolowana
RUS Головка шестигранная короткая изолированная
CZ Šestihránný nástavec, izolovaný
H Hatszögű rátét
RO Cheie tubulară hexagonală izolată
F Douille courte isolée
I Chiave a bussola esagonale isolato
E Boquilla hexagonal corta aislante
CN 绝缘六角套筒

1/2" 12.5mm
 CrV
 1000 V

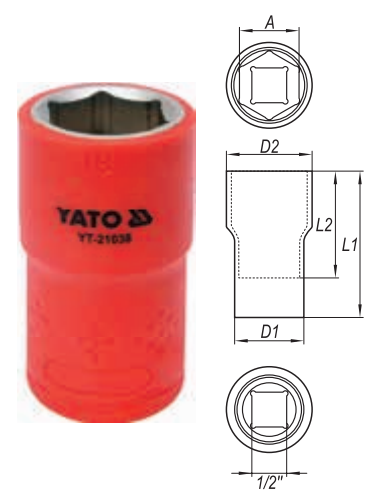



1000V
 VDE CERTIFICATE
 EN 60900:2012

YATO	Ø A (mm)	D1 (mm)	D2 (mm)	L1 (mm)	L2 (mm)	
YT-21030	10	27	19.5	55	38	12/144
YT-21031	11	27	20.7	55	38	12/144
YT-21032	12	27	22.0	55	38	12/144
YT-21033	13	27	23.2	55	38	12/144
YT-21034	14	27	24.5	55	38	12/144
YT-21036	16	27	27.0	55	38	12/144
YT-21037	17	27	28.5	55	38	12/144
YT-21038	18	27	29.5	55	38	12/144
YT-21039	19	27	30.7	55	38	12/144
YT-21041	21	27	33.2	55	38	10/110
YT-21042	22	27	34.5	55	38	10/110
YT-21044	24	27	37.0	60	38	10/110
YT-21047	27	27	38.8	60	38	6/66
YT-21050	30	27	42.8	60	38	6/66
YT-21052	32	27	44.8	60	38	6/66

GB Bi-hexagonal socket
D Zwölfkant-Steckschlüssel-Einsatz
PL Nasadka dwunastokątna
RUS Головка 12-гранная
CZ Nástrčný oheč dvanáctihřanný
H Dugófej, 12 lapú
RO Cheie tubulară bihexagonală
F Douille courte
I Chiave a bussola bi-esagonale
E Boquilla de anillo
CN 十二角套筒

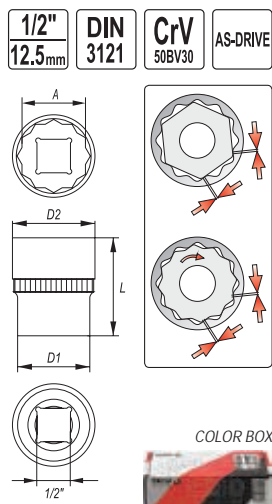
- drive locks
- surface finish: chromed, satin / mirror
- zamki blokujące
- wykończenie powierzchni: chromowana, satynowa / polerowana



COLOR BOX

YATO	∅ A (mm)	D1 (mm)	D2 (mm)	L (mm)	PCS packing:	
YT-1270	8	12	22	38	12	120/240
YT-1271	9	14	22	38	12	120/240
YT-1272	10	15	22	38	12	120/240
YT-1273	11	16	22	38	12	120/240
YT-1274	12	17	22	38	12	120/240
YT-1275	13	19	22	38	12	120/240
YT-1276	14	20	22	38	12	120/240
YT-1277	15	21	22	38	12	120/240
YT-1278	16	23	22	38	12	120/240
YT-1279	17	24	22	38	12	120/240
YT-1280	18	25	23	38	12	120/240
YT-1281	19	27	24	38	12	120/240
YT-1282	20	28	24	38	12	120/240
YT-1283	21	29	24	38	12	120/240
YT-1284	22	30	26	38	12	120/240
YT-1285	23	31	28	38	12	60/120
YT-1286	24	32	28	38	12	60/120
YT-1289	27	36	30	42	12	60/120
YT-1291	30	40	34	42	12	48/96
YT-1292	32	42	36	42	12	48/96

GB Spline socket
D Steckschlüssel Spline
PL Nasadka Spline
RUS Головка Spline
CZ Nástrčný klíč profil Spline
H Spline dugófej
RO Cheie tubulară cu stifturi
F Douille
I Chiave a bussola spline
E Boquilla Spline
CN 花键型套筒

- drive locks
- enables to undo 5 types of screws
- surface finish: chromed, satin / mirror
- zamki blokujące
- możliwość odkręcenia 5 rodzajów śrub
- wykończenie powierzchni: chromowana, satynowa / polerowana

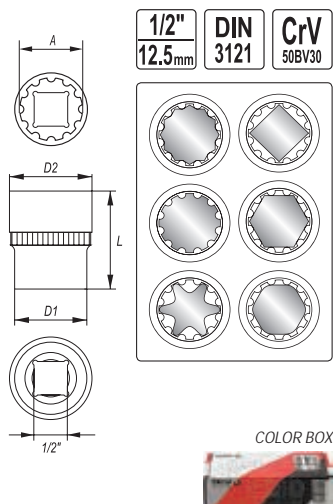

COLOR BOX

YATO	∅ A (mm)	D1 (mm)	D2 (mm)	L (mm)	PCS packing:	
YT-1460	8	13	22	38	12	120/240
YT-1461	9	15	22	38	12	120/240
YT-1462	10	16	22	38	10	100/200
YT-1463	11	17	22	38	10	100/200
YT-1464	12	18	22	38	10	100/200
YT-1465	13	19	22	38	12	120/240
YT-1466	14	20	22	38	10	100/200
YT-1467	15	22	23	38	12	120/240
YT-1468	16	23	22	38	12	120/240
YT-1469	17	25	23	38	10	100/200
YT-1470	18	26	23	38	12	120/240
YT-1471	19	27	24	38	12	120/240
YT-1472	20	28	24	38	10	100/200
YT-1473	21	30	24	38	10	100/200
YT-1474	22	31	26	38	12	120/240
YT-1475	23	32	28	38	12	60/120
YT-1476	24	34	28	38	12	60/120
YT-1478	27	37	30	42	12	60/120
YT-1480	30	41	34	42	6	60/120
YT-1481	32	44	36	42	6	60/120

GB Hexagonal deep socket
D Sechskantenschlüssel, lange
PL Nasadka sześciokątna długa
RUS Головка шестигранная длинная
CZ Šestihranný hluboký nástavec
H Hatszögű rátét mély hexagonalá adáncá
RO Cheie tubulară hexagonală adâncă
F Douille longue
I Chiave a bussola bi-esagonale
E Boquilla hexagonal larga
CN 六角长套筒

- drive locks
- surface finish: chromed, satin / mirror
- zamki blokujące
- wykończenie powierzchni: chromowana, satynowa / polerowana

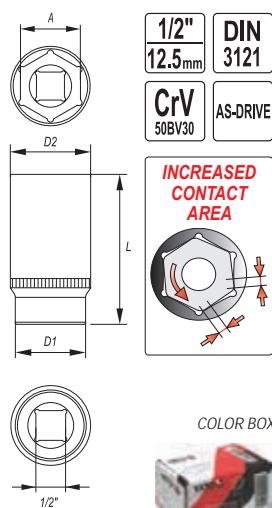

COLOR BOX

YATO	∅ A (mm)	D1 (mm)	D2 (mm)	L (mm)	PCS packing:	
YT-1221	8	13	22	76	12	60/120
YT-1222	9	14	22	76	12	60/120
YT-1223	10	15	22	76	12	60/120
YT-1224	11	17	22	76	12	60/120
YT-1225	12	18	22	76	12	60/120
YT-1226	13	19	22	76	12	60/120
YT-1227	14	20	22	76	12	60/120
YT-1228	15	21	22	76	12	60/120
YT-1229	16	24	22	76	12	60/120
YT-1230	17	24	22	76	12	60/120
YT-1231	18	25	23	76	12	60/120
YT-1232	19	27	24	76	12	60/120
YT-1233	20	28	24	76	12	60/120
YT-1234	21	29	24	76	12	60/120
YT-1235	22	30	26	76	12	60/120
YT-1236	23	31	28	76	12	60/120
YT-1237	24	32	28	76	12	60/120
YT-1238	27	36	30	76	12	36/72
YT-1239	30	40	36	76	12	24/48
YT-1240	32	42	38	76	12	24/48

GB Bi-hexagonal deep socket
D Zwölfkant-Steckschlüssel-Einsatz, lange
PL Nasadka dwunastokątna długa
RUS Головка 12-гранная длинная
CZ Dvanáctihřanný hluboký nástavec
H Dugófej, 12 lapú
RO Cheie tubulară bihexagonală adâncă
F Douille longue
I Chiave a bussola bi-esagonale
E Boquilla de anillo larga
CN 十二角长套筒

- drive locks
- surface finish: chromed, satin / mirror
- zamki blokujące
- wykończenie powierzchni: chromowana, satynowa / polerowana

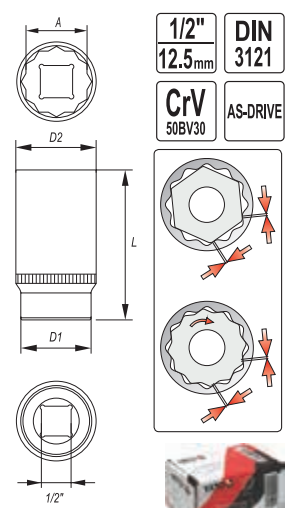

COLOR BOX

YATO	∅ A (mm)	D1 (mm)	D2 (mm)	L (mm)	PCS packing:	
YT-12930	8	22	14	77	12	60/120
YT-12931	9	22	16	77	12	60/120
YT-12932	10	22	16	77	12	60/120
YT-12933	11	22	18	77	12	60/120
YT-12934	12	22	18	77	12	60/120
YT-12935	13	22	19	77	12	60/120
YT-12936	14	22	19	77	12	60/120
YT-12937	15	21	22	77	12	60/120
YT-12938	16	21	22	77	12	60/120
YT-12939	17	22	24	77	12	60/120
YT-12940	18	22	26	77	12	60/120
YT-12941	19	22	26	77	12	60/120
YT-12942	20	24	28	77	12	60/120
YT-12943	21	24	28	77	12	60/120
YT-12944	22	26	30	77	12	60/120
YT-12945	23	27	32	77	12	60/120
YT-12946	24	28	32	77	12	60/120
YT-12947	27	30	36	77	12	36/72
YT-12948	30	34	40	77	12	24/48
YT-12949	32	36	42	77	12	24/48

GB Extension bar
D Verlängerung
PL Przedłużka
RUS Удлинитель
для воротка
CZ Prodlužovací příravek
H Toldalék
RO Prelungitor
F Rallonge
I Prolunga
E Tubo de prolongación
CN 接杆

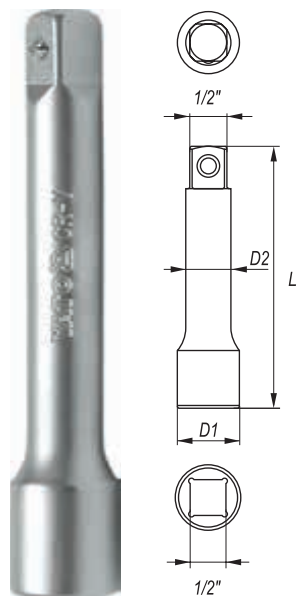

1/2"
12.5mm
DIN
3121
CrV
50BV30

COLOR BOX



YATO	Ø	D1 (mm)	D2 (mm)	L (mm)	PCS packing	
YT-1246	1/2" (12.7 mm)	24.0	14.5	76	10	30/120
YT-1247	1/2" (12.7 mm)	24.0	14.5	127	5	20/80
YT-1248	1/2" (12.7 mm)	24.0	14.5	254	5	20/40

GB Insulated extension bar
D Verlängerung vollisoliert
PL Przedłużka izolowana
RUS Удлинитель
для воротка
CZ Prodlužovací příravek,
izolovaný
H Toldalék
RO Prelungitor izolat
F Rallonge isolée
I Prolunga isolato
E Tubo de prolongación
aislante
CN 绝缘接杆

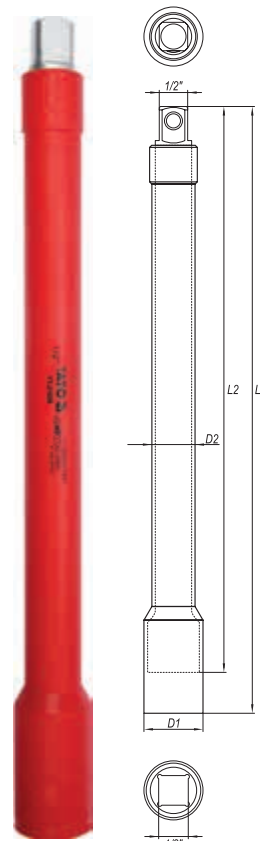

1/2"
12.5mm
CrV
1000
V
D'E

1000V
VDE CERTIFICATE
EN 60900:2012

POLYBAG



YATO	Ø	D1 (mm)	D2 (mm)	L1 (mm)	L2 (mm)	
YT-21057	1/2" (12.7 mm)	27	19.1	125	141	6/72
YT-21058	1/2" (12.7 mm)	27	19.1	250	266	8/32

GB Extension bar with wobble
D Gelenverlängerung
PL Przedłużka uchylna
RUS Удлинитель наклонный
CZ Odchylný prodlužovací
příravek
H Csuklós toldalék
RO Prelungitor rabatabil
F Rallonge angulaire
I Prolunga
E Tubo de prolongación
desviable
CN 转向接杆

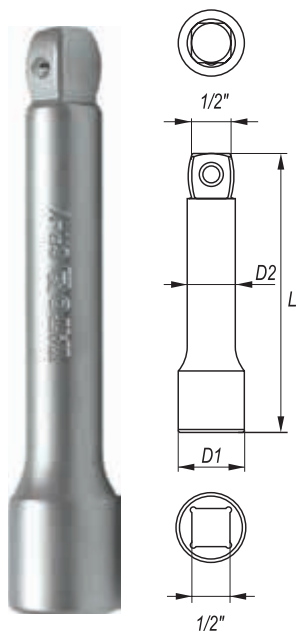

1/2"
12.5mm
DIN
3121
CrV
50BV30

COLOR BOX



YATO	Ø	D1 (mm)	D2 (mm)	L (mm)	PCS packing	
YT-1249	1/2" (12.7 mm)	24.0	14.5	76	15	30/120
YT-1250	1/2" (12.7 mm)	24.0	14.5	127	5	20/80
YT-1251	1/2" (12.7 mm)	24.0	14.5	254	5	20/40

GB Adapter
D Reduktion
PL Redukcja
RUS Переходник
CZ Redukce
H Redukció
RO Reducție
F Réduction
I Riduttore
E Reducción
CN 转换头

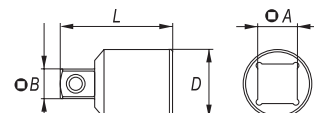

1/2"
12.5mm
3/4"
19mm
DIN
3121
CrV
50BV30

COLOR BOX



YATO	Ø A	Ø B	D (mm)	L (mm)	PCS packing	
YT-1255	1/2" (12.7 mm) (F)	3/8" (9.5 mm) (M)	22	34.0	10	100/200
YT-1258	1/2" (12.7 mm) (F)	3/4" (19.0 mm) (M)	27	45.5	10	50/100
YT-1259	3/4" (19.0 mm) (F)	1/2" (12.7 mm) (M)	35	51.0	5	50/100
YT-1356	1/2" (12.7 mm) (F)	3/4" (19.0 mm) (M)	26	48.0	12	48

GB Bit adapter
D Bithalter
PL Adapter do bitów
RUS Держатель винтовёртовых
наконечников
CZ Držák na šroubovavové
koncovky
H Szár a csavarhúzóvéghez
RO Capete şurubelniță
F Adapteur d'embouts
I Chiave esagonale
a bussola
E Mandril para puntas
CN 旋具头接头

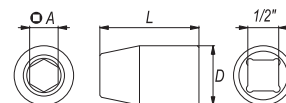

1/2"
12.5mm
CrV
6140

COLOR BOX



YATO	Ø	Ø A	D (mm)	L (mm)	PCS packing	
YT-1295	1/2" (12.7 mm)	8 mm	21.9	38	10	250/500

GB Universal joint
D Kardangelenk
PL Przegub Cardana
RUS Карданный шарнир
CZ Kardanový kloub
H Kardán csukló

RO Articulație Cardanică
F Cardan
I Snodo cardanico
E Articulación Cardan
CN 万向接头

1/2" 12.5mm
DIN 3121
CrV 50BV30

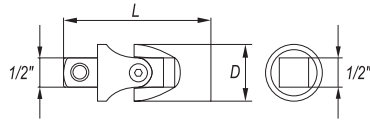

COLOR BOX

YATO	Ø	D (mm)	L (mm)	PCS packing:	
YT-1252	1/2" (12.7 mm)	25	69	5	50/100

GB Sliding T-bar
D Handgriff mit Gleitstück
PL Pokręto typu „T”
RUS Вороток Т-образный

CZ Otočná račká typ „T”
H „T” alakú hajtókar
RO Mâner clupă tipul „T”
F Barre type „T”

I Manopola „T” scorrevole
E Mango tipo „T”
CN 滑行杆

1/2" 12.5mm

DIN 3121

CrV 50BV30

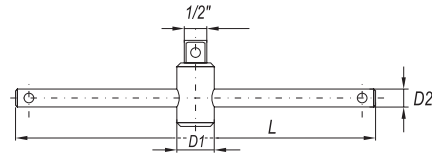

COLOR BOX

YATO	Ø	D1 (mm)	D2 (mm)	L (mm)	PCS packing:	
YT-1243	1/2" (12.7 mm)	24.0	13.5	255	4	24/48

GB Flexible handle
D Gelenkgriff
PL Pokręto lamane

RUS Вороток шарнирный
CZ Otočná lomená ráčka
H Hajlított hajtókar

RO Prelungitor cu prindere flexibilă
F Barre pivotante

I Manopola a snodo
E Mango articulado
CN 转向手柄

1/2" 12.5mm

DIN 3121

CrV 50BV30

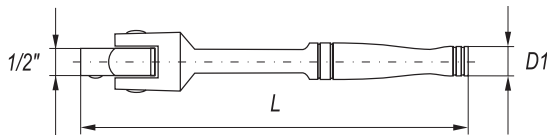

COLOR BOX

YATO	Ø	D (mm)	L (mm)	PCS packing:	
YT-1241	1/2" (12.7 mm)	19	360	5	15/30
YT-1242	1/2" (12.7 mm)	20	457	5	10/20

GB L-type handle
D Admutternschlüssel
PL Pokręto typu „L”
RUS Вороток 1/2" тип „L”
CZ Páka zahnutá
H „L” alakú hajtókar
RO Mâner clupă tipul „L”
F Barre type „L”
I Leva tipo „L”
E Mango tipo „L”
CN L型套筒扳手

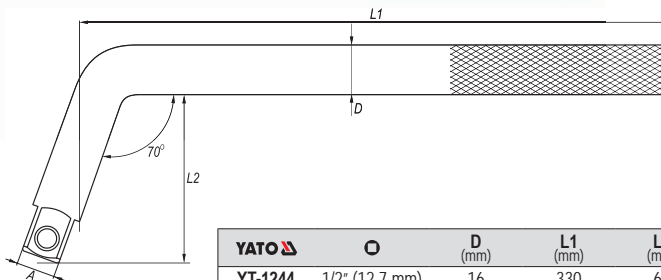
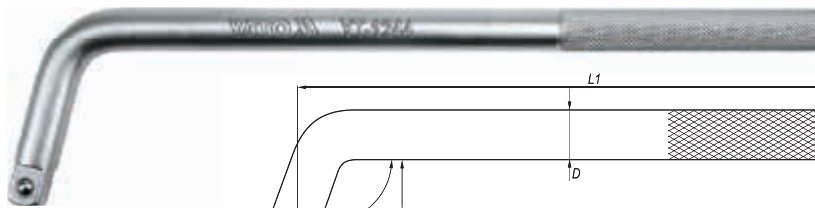

COLOR BOX

YATO	Ø	D (mm)	L1 (mm)	L2 (mm)	PCS packing:	
YT-1244	1/2" (12.7 mm)	16	330	62	3	36

GB L-type handle
D Admutternschlüssel
PL Pokręto typu „L”
RUS Вороток 1/2" тип „L”
CZ Páka zahnutá
H „L” alakú hajtókar
RO Mâner clupă tipul „L”
F Barre type „L”
I Leva tipo „L”
E Mango tipo „L”
CN L型套筒扳手

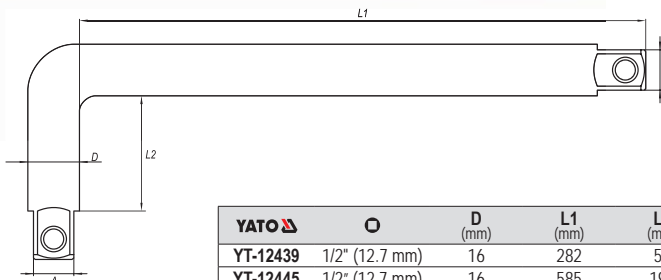
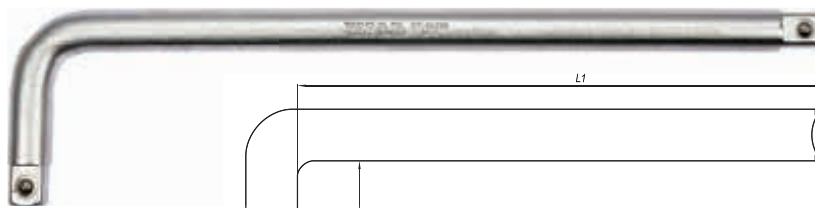

COLOR BOX

YATO	Ø	D (mm)	L1 (mm)	L2 (mm)	PCS packing:	
YT-12439	1/2" (12.7 mm)	16	282	55	10	20
YT-12445	1/2" (12.7 mm)	16	585	190	2	12

GB Spark plug socket
D Steckschlüssel mit Gummihalterung
PL Nasadka do świec
RUS Головка свечная
CZ Nastavec pro svíčky
H Gyújtógyertya toldalék
RO Cheie de bujii
F Douille à bougies
I Chiavi a bussola
E Boquilla de bujías
CN 六角火花塞套筒

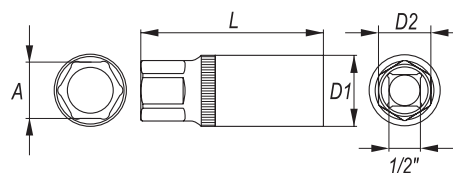

1/2" 12.5mm

DIN 3121

CrV 50BV30

AS-DRIVE

COLOR BOX

YATO	Ø	A	D1 (mm)	D2 (mm)	L (mm)	PCS packing:	
YT-1253	1/2" (12.7 mm)	16.0	22.0	19.0	64.0	10	50/100
YT-1254	1/2" (12.7 mm)	21.0	27.8	24.0	64.0	10	50/100

GB Quick release ratchet handle
D Hebelumschaltknarre
PL Grzechotka
RUS Трещотка
CZ Řehtačka
H Racsnis hajtókar

RO Dispozitiv de prindere cu clichet
F Clé à cliquet
I Cricchetto bussola
E Carraca
CN 快速脱落棘轮扳手

PLASTIC HANGER



6 PCS



COLOR BOX

1/2"
12.5mm

DIN
3122

QUICK
RELEASE
SZYBKO-
ZŁĄCZE

72T

CrV
6140

2



YATO	Ø	T	L (mm)	PCS packing:	Box
YT-0309	1/2" (12.7 mm)	72	278	6	24

YATO	Ø	T	L (mm)	PCS packing:	Box
YT-0312	1/2" (12.7 mm)	72	250	6	12/24

YATO	Ø	T	L (mm)	PCS packing:	Box
YT-0315	1/2" (12.7 mm)	72	250	6	24



YATO	Ø	T	L (mm)	PCS packing:	Box
YT-0318	1/2" (12.7 mm)	72	250	6	24

YATO	Ø	T	L (mm)	PCS packing:	Box
YT-0321	1/2" (12.7 mm)	72	255	6	24

YATO	Ø	T	L (mm)	PCS packing:	Box
YT-0324	1/2" (12.7 mm)	72	265	6	24

GB Quick release ratchet handle
D Hebelumschaltknarre
PL Grzechotka
RUS Трещотка

CZ Řehtačka
H Racsnis hajtókar

I Cricchetto bussola
E Carraca

RO Dispozitiv de prindere cu clichet
F Clé à cliquet
CN 快速脱落棘轮扳手

1/2"
12.5mm

QUICK
RELEASE
SZYBKO-
ZŁĄCZE

DIN
3122

72T

CrV
6140

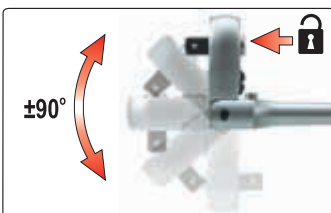

PLASTIC HANGER

6 PCS



COLOR BOX

YATO	Ø	T	L (mm)	PCS packing:	Box
YT-0327	1/2" (12.7 mm)	72	290	6	24

GB Quick release ratchet handle
D Hebelumschaltknarre
PL Grzechotka powlekana
RUS Трещотка
CZ Řehtačka
H Racsnis hajtókar

RO Dispozitiv de prindere cu clichet
F Clé à cliquet
I Cricchetto bussola
E Carraca
CN 快速脱落棘轮扳手

PLASTIC HANGER



6 PCS



1/2"
12.5mm

DIN
3122

QUICK
RELEASE
SZYBKO-
ZŁĄCZE

72T

CrV
6135



YATO	Ø	T	L (mm)	PCS packing:	Box
YT-0292	1/2" (12.7 mm)	72	257	6	24

YATO	Ø	T	L (mm)	PCS packing:	Box
YT-0295	1/2" (12.7 mm)	72	257	6	24

GB Insulated ratchet handle
D Hebelumschaltknarre vollisoliert
PL Grzechotka izolowana
RUS Трещотка диэлектрическая
CZ Řehtačka, izolovaná
H Racsnis hajtókar
RO Antrenor cu clichet izolat
F Clé à cliquet isolée
I Cricchetto bussola isolato
E Carraca aislante
CN 绝缘棘轮扳手



1/2"
12.5mm

CrV

1000
V



POLYBAG

1000V
VDE CERTIFICATE
EN 60900:2012



YATO	Ø	T	L (mm)	Box
YT-21072	1/2" (12.7 mm)	36	250	6/36

- GB** Quick release ratchet handle
D Hebelumschaltknarre
PL Grzechotka
RUS Трещотка
CZ Řehtačka
H Racsnis hajtókar
RO Dispozitiv de prindere cu clichet
F Clé à cliquet
I Cricchetto bussola
E Carraca
CN 快速脱落棘轮扳手

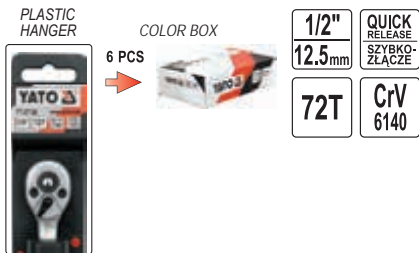

1/2"	QUICK RELEASE SZYBKO-ZŁĄCZE
12.5mm	
72T	CrV 6140



YATO	Ø	T	L (mm)	PCS packing:	
YT-0732	1/2" (12.7 mm)	72	255	6	24

- GB** Quick release ratchet handle
D Hebelumschaltknarre
PL Grzechotka
RUS Трещотка
CZ Řehtačka
H Racsnis hajtókar
RO Dispozitiv de prindere cu clichet
F Clé à cliquet
I Cricchetto bussola
E Carraca
CN 快速脱落棘轮扳手

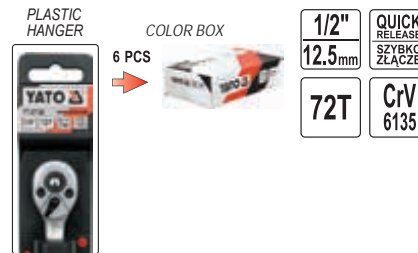

1/2"	QUICK RELEASE SZYBKO-ZŁĄCZE
12.5mm	
72T	CrV 6135



YATO	Ø	T	L (mm)	PCS packing:	
YT-0735	1/2" (12.7 mm)	72	255	6	24

- GB** Telescopic ratchet handle
D Umschaltknarre
PL Grzechotka z przedłużanym uchwytem
RUS Трещотка
CZ Řehtačka
H Racsnis hajtókar
RO Antrenor cu clichet
F Clé à cliquet
I Cricchetto bussola
E Carraca telescópico
CN 可伸缩快速脱落棘轮扳手

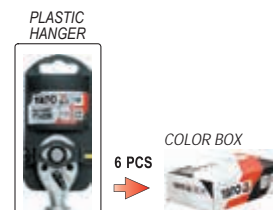

1/2"	QUICK RELEASE SZYBKO-ZŁĄCZE
12.5mm	
72T	CrV 6135

YATO	Ø	T	L (mm)	PCS packing:	
YT-0299	1/2" (12.7 mm)	72	305-445	6	24

- GB** Flexible ratchet handle / round head
D Flexible Drehkopfratsche
PL Grzechotka z obrotową głowicą
RUS Трещотка с вращательной головкой
CZ Ráčna s otočnou hlavou
H Forgófejes racsnis szár
RO Antrenor cu clichet flexibil
F Clé à cliquet tête pivotante
I Cricchetto bussola reversibile con ghiera
E Carraca con cabeza giratoria
CN 旋转头快速脱落棘轮扳手

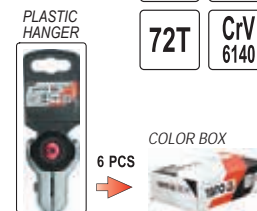

1/2"	QUICK RELEASE SZYBKO-ZŁĄCZE
12.5mm	
72T	CrV 6140

YATO	Ø	T	L (mm)	PCS packing:	
YT-0722	1/2" (12.7 mm)	72	280	6	30

- GB** Internal ratchet wrench
D Innenratschenschlüssel
PL Grzechotka wewnętrzna
RUS Трещотка внутренняя
CZ Radiátorový kluč s ráčnou
H Lépcsős kulcskészlet racsnival
RO Cheie robinet radiator
F Clé de montage étagée
I Cricchetto di tipo interno
E Llave carraca radiadores
CN 穿心棘轮扳手

1/2"	CrV	30T
12.5mm		



for / dla: YT-03316

TIED ON CARD

YATO	Ø	
YT-03315	1/2" (12.7 mm)	6/24

- GB** Step wrench
D Stufenschlüssel
PL Klucz stopniowy
RUS Калибратор FORA для металлопластиковых труб
CZ Klíč na radiátorové šroubení
H Lépcsős radiátor kulcs
RO Cheie in trepte pt. radiator
F Clé de montage étagée
I Chiave a cricco
E Llave de radiadores
CN 散熱六角階梯扳手

1/2"	3/8"	29/68"	1/2"	21/32"	27/32"
12.5mm	9.6 mm	11.6 mm	12.6 mm	16.4 mm	21 mm



for / dla: YT-03315

POLYBAG WITH HEADER

YATO	Ø	
YT-03316	1/2" (12.7 mm)	100

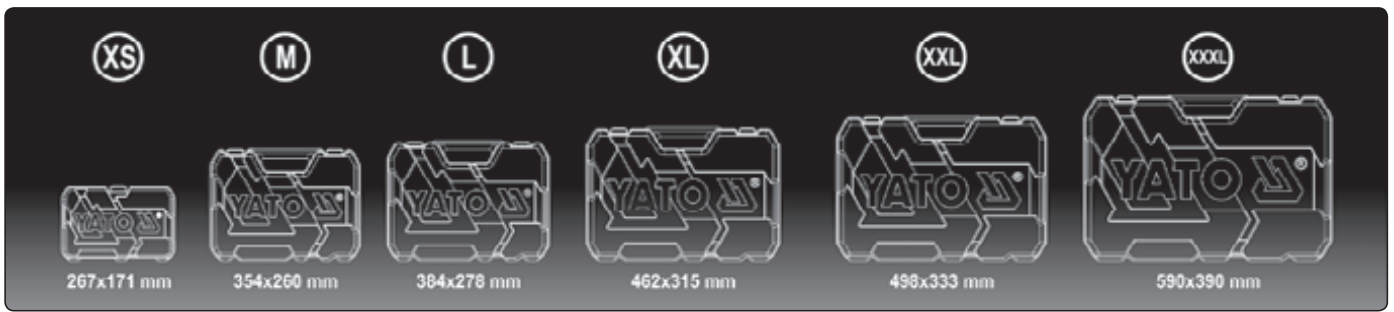

GB Socket set
D Sechskant-Steckschlüssel-Satz
PL Komplet nasadek dlugich
RUS Набор насадок
CZ Sada nástrčných kľučí
H Dugókulcs készlet

RO Trusă chei tubulare
F Set de douilles longues
I Serie di chiavi a bussola lunghi
E Juego de herramientas
CN 长套筒组套

8 PCS
1/4"
6.3mm

CrV
50BV30

AS-DRIVE

GB Tool set
D Sechskant-Steckschlüssel- Satz
PL Zestaw narzędziowy
RUS Набор инструмента
CZ Sada nástrčných kľučí a ráčny
H Dugókulcs készlet racsnis hajtókarral

RO Rotrusa chei tubulare cu antrenor
F Coffret d'outillage
I Set di utensili
E Juego de herramientas de herramientas
CN 套筒扳手组套

20 PCS
1/4"
6.3mm

CrV
50BV30

CrMo
440

72T

AS-DRIVE



1/4" (6.3 mm): 5.5, 6, 7, 8, 9, 10, 12, 13 mm (L=50 mm); CrV 50BV30

PLASTIC HANGER



YATO		
YT-14431	1/4" (6.3 mm)	10/20

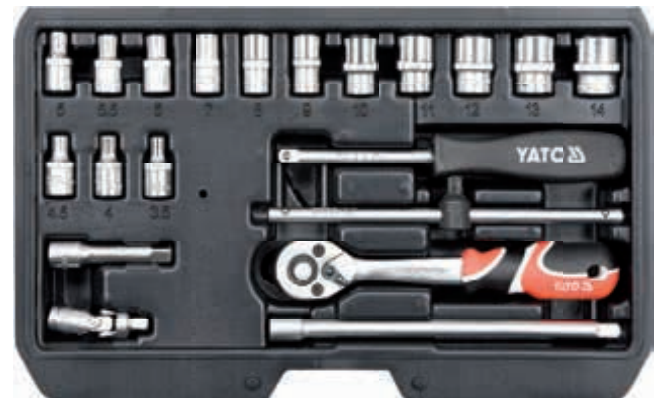

1/4" (6.3 mm): 3.5, 4, 4.5, 5, 5.5, 6, 7, 8, 9, 10, 11, 12, 13, 14 mm (L=25 mm); CrV 50BV30;
1/4" (6.3 mm): (51.6, 151.5 mm); CrV 50BV30;
1/4" (6.3 mm); CrV 50BV30;
1/4" (6.3 mm): (152.8 mm); CrV 50BV30;
1/4" (6.3 mm): (155 mm); 72T; CrMo 440;
1/4" (6.3 mm): (150 mm); CrV 50BV30

BMC & COLOR SLEEVE XS SIZE



YATO		
YT-14491	1/4" (6.3 mm)	10

GB Tool set
D Sechskant-Steckschlüssel-Satz
PL Zestaw narzędziowy
RUS Набор инструмента

CZ Sada nástrčných kľučí a ráčny
H Dugókulcs készlet racsnis hajtókarral
RO Rotrusa chei tubulare cu antrenor
F Coffret d'outillage

I Set di utensili
E Juego de herramientas
CN 套筒扳手组套

BMC & COLOR SLEEVE XS SIZE



1/4"
6.3mm

CrV
50BV30

CrMo
440

72T

AS-DRIVE



23 PCS

1/4" (6.3 mm): 4, 5, 6, 7, 8, 9, 10, 12, 13 mm (L=25 mm); CrV 50BV30;
1/4" (6.3 mm): 4, 5, 6, 7, 8, 9, 10, 12, 13 mm (L=50 mm); CrV 50BV30;
1/4" (6.3 mm): (50.8, 152.4 mm); CrV 50BV30;
1/4" (6.3 mm); CrV 50BV30;
1/4" (6.3 mm): (152.4 mm); CrV 40;
1/4" (6.3 mm): (155 mm); 72T; CrMo 440;
1/4" (6.3 mm): (150 mm); CrV 50BV30

YATO		
YT-14451	1/4" (6.3 mm)	10



25 PCS

1/4" (6.3 mm): 3.5, 4, 4.5, 5, 5.5, 6, 7, 8, 9, 10, 11, 12, 13, 14 mm (L=25 mm); CrV 50BV30;
1/4" (6.3 mm): 8, 10, 11, 12, 13 mm (L=50 mm); CrV 50BV30;
1/4" (6.3 mm): (50.8, 101.6 mm); CrV 50BV30;
1/4" (6.3 mm); CrV 50BV30;
1/4" (6.3 mm): (152.4 mm); CrV 40;
1/4" (6.3 mm): (155 mm); 72T; CrMo 440;
1/4" (6.3 mm); (150 mm); CrV 50BV30

YATO		
YT-14461	1/4" (6.3 mm)	10

GB Tool set
D Sechskant-Steckschlüssel-Satz
PL Zestaw narzędziowy
RUS Набор инструмента

CZ Sada nástrčných klíčů a ráčny
H Dugókulcs készlet racsnis hajtókarral
RO Rotrușă chei tubulare cu antrenor
F Coffret d'outillage

I Set di utensili
E Juego de herramientas
CN 套筒扳手组套

BMC & COLOR SLEEVE
 XS SIZE



1/4" 6.3mm	CrV 50BV30	CrV 6150	CrV 40
CrMo 440	S2	72T	AS-DRIVE

2



38
PCS

- 1/4" (6.3 mm): 3.5, 4, 4.5, 5, 5.5, 6, 7, 8, 9, 10, 11, 12, 13, 14 mm (L=25 mm); CrV 50BV30;
- 1/4" (6.3 mm): (50.8, 101.6 mm); CrV 50BV30;
- 1/4" (6.3 mm): CrV 50BV30;
- 1/4" (6.3 mm): (152.4 mm); CrV 40;
- 1/4" (6.3 mm): (155 mm); 72T; CrMo 440;
- 1/4" (6.3 mm): (150 mm); CrV 50BV30;
- 1/4" (6.3 mm): 4, 5.5, 6.5 mm (L=37 mm); AISI S2 / CrV 6150;
- 1/4" (6.3 mm): PH1, PH2 (L=37 mm); AISI S2 / CrV 6150;
- 1/4" (6.3 mm): PZ1, PZ2 (L=37 mm); AISI S2 / CrV 6150;
- 1/4" (6.3 mm): T10, T15, T20, T25, T30, T40 (L=37 mm); AISI S2 / CrV 6150;
- 1/4" (6.3 mm): 3, 4, 5, 6, 8 mm (L=37 mm); AISI S2 / CrV 6150

YATO		
YT-14471	1/4" (6.3 mm)	10



42
PCS

- 1/4" (6.3 mm): 4, 4.5, 5, 5.5, 6, 7, 8, 9, 10, 11, 12, 13, 14 mm (L=25 mm); CrV 50BV30;
- 1/4" (6.3 mm): 8, 9, 10, 11, 12, 13 mm (L=50 mm); CrV 50BV30;
- 1/4" (6.3 mm): (50.8, 101.6 mm); CrV 50BV30;
- 1/4" (6.3 mm): (150 mm); CrV 50BV30;
- 1/4" (6.3 mm): CrV 50BV30;
- 1/4" (6.3 mm): (152.4 mm); CrV 40;
- 1/4" (6.3 mm): (155 mm); 72T; CrMo 440;
- 1/4" (6.3 mm): (150 mm); CrV 50BV30;
- 1/4" (6.3 mm) x 1/4" (6.3 mm): CrV 50BV30;
- 1/4" (6.3 mm): 3, 4, 5 mm (L=25 mm); AISI S2;
- 1/4" (6.3 mm): PH0, PH1, PH2 (L=25 mm); AISI S2;
- 1/4" (6.3 mm): PZ0, PZ1, PZ2 (L=25 mm); AISI S2;
- 1/4" (6.3 mm): 6, 7, 8 mm (L=25 mm); AISI S2;
- 1.5, 2.0, 2.5 mm; CrV 6150

YATO		
YT-14481	1/4" (6.3 mm)	6



56
PCS

- 1/4" (6.3 mm): 4, 4.5, 5, 5.5, 6, 7, 8, 9, 10, 11, 12, 13 mm (L=25 mm); CrV 50BV30;
- 1/4" (6.3 mm): 6, 7, 8, 9, 10, 11, 12, 13 mm (L=50 mm); CrV 50BV30;
- 1/4" (6.3 mm): E4, E5, E6, E7, E8, E10; CrV 6150;
- 1/4" (6.3 mm): (76, 152.4 mm); CrV 50BV30;
- 1/4" (6.3 mm): (150 mm); CrV 50BV30;
- 1/4" (6.3 mm): CrV 50BV30;
- 1/4" (6.3 mm): (152.4 mm); CrV 40;
- 1/4" (6.3 mm): (155 mm); 72T; CrMo 440;
- 1/4" (6.3 mm): (150 mm); CrV 50BV30;
- 1/4" (6.3 mm) (F) x 3/8" (9.5 mm) (M); CrV 50BV30;
- 1/4" (6.3 mm): 4, 5.5, 6.5 mm (L=37 mm); AISI S2 / CrV 6150;
- 1/4" (6.3 mm): PH1, PH2, PH3 (L=37 mm); AISI S2 / CrV 6150;
- 1/4" (6.3 mm): PZ1, PZ2, PZ3 (L=37 mm); AISI S2 / CrV 6150;
- 1/4" (6.3 mm): T8, T10, T15, T20, T25, T30, T40 (L=37 mm); AISI S2 / CrV 6150;
- 1/4" (6.3 mm): 3, 4, 5, 6, 7, 8 mm (L=37 mm); AISI S2 / CrV 6150

YATO		
YT-14501	1/4" (6.3 mm)	10

GB Tool set
D Sechskant-Steckschlüssel-Satz
PL Zestaw narzędziowy
RUS Набор инструмента

CZ Sada nástrčných klíčů a ráčny
H Dugókulcs készlet racsnis hajtókarral
RO Rotrusa chei tubulare cu antrenor
F Coffret d'outillage

I Set di utensili
E Juego de herramientas
CN 套筒扳手组套

BMC & COLOR SLEEVE
XS SIZE



22 PCS	3/8" 10mm	CrV 50BV30	CrV 40
CrMo 440	72T	AS-DRIVE	



3/8" (9.5 mm): 6, 7, 8, 9, 10, 11, 12, 13, 14, 15, 16 mm (L=28 mm);
17, 18, 19, 20, 21, 22 mm (L=30 mm); CrV 50BV30;
3/8" (9.5 mm): (76, 152.4 mm); CrV 50BV30;
3/8" (9.5 mm): CrV 50BV30;
3/8" (9.5 mm): (198 mm); CrV 40;
3/8" (9.5 mm): (200 mm); 72T; CrMo 440

YATO	3/8" (9.5 mm)	10
YT-38561		

GB Socket set
D Sechskant-Steckschlüssel-Satz
PL Komplet nasadek dlugich
RUS Набор насадок

CZ Sada nástrčných klíčů
H Dugókulcs készlet
RO Trusă chei tubulare
F Set de douilles longues

I Serie di chiavi a bussola lunghi
E Juego de boquillas
CN 长套筒组套

PLASTIC HANGER



10 PCS	1/2" 12.5mm	CrV 50BV30
AS-DRIVE		



1/2" (12.7 mm): 10, 12, 13, 14, 15, 17, 19, 21, 22, 24 mm
(L=76 mm); CrV 50BV30

YATO	1/2" (12.7 mm)	10
YT-38861		

GB Socket set
D Sechskantenschlüssel-Einsatz
PL Komplet nasadek z akcesoriami
RUS Набор торцевых головок

CZ Sada nástrčných klíčů a ráčny
H Dugókulcs készlet racsnis hajtókarral
RO Trusă chei tubulare cu antrenor
F Set de douilles + accessoires

I Serie di chiavi a con accessori
E Juego de boquillas con accesorios
CN 套筒扳手组套

PLASTIC HANGER



12 PCS	1/2" 12.5mm	CrV 50BV30
CrMo 440	72T	AS-DRIVE



1/2" (12.7 mm): 10, 11, 12, 13, 14, 15, 17, 19, 21, 24 mm (L=38 mm);
CrV 50BV30;
1/2" (12.7 mm): (127 mm); CrV 50BV30;
1/2" (12.7 mm): (255 mm); 72T; CrMo 440

YATO	1/2" (12.7 mm)	5/10
YT-38821		

GB Ratchet handle with socket set
D Sechskant-Steckschlüssel-Satz
PL Komplet nasadek z grzechotką
RUS Набор насадок

CZ Sada nástrčných klíčů a ráčny
H Dugókulcs készlet racsnis hajtókarral
RO Rotrusa chei tubulare cu antrenor
F Clé mixte à cliquet + douilles

I Serie di chiavi con cricchetto
E Matraca con boquillas
CN 套筒扳手组套

PLASTIC HANGER



19 PCS	1/2" 12.5mm	CrV 50BV30
CrMo 440	72T	AS-DRIVE



1/2" (12.7 mm): 8, 9, 10, 11, 12, 13, 14, 15, 16, 17, 19, 21, 22, 23, 24 mm
(L=38 mm); 27, 30, 32 mm (L=42 mm); CrV 50BV30;
1/2" (12.7 mm): (255 mm); 72T; CrMo 440

YATO	1/2" (12.7 mm)	3/6
YT-38681		

GB Tool set
D Sechskant-Steckschlüssel-Satz
PL Zestaw narzędziowy

RUS Набор инструмента
CZ Sada nástrčných klíčů a ráčny
H Dugókulcs készlet racsnis hajtókkal

RO Rotrusa chei tubulare cu antrenor
F Coffret d'outillage
I Set di utensili

E Juego de herramientas
CN 套筒扳手组套

1/2"
12.5mm
CrV
50BV30
72T
AS-DRIVE

2



BMC & COLOR SLEEVE XS SIZE



12
PCS
CrMo
440

- 1/2" (12.7 mm): 10, 11, 12, 13, 14, 15, 17, 19, 21, 24 mm (L=38 mm); CrV 50BV30;
- 1/2" (12.7 mm): (127 mm); CrV 50BV30;
- 1/2" (12.7 mm): (255 mm); 72T; CrMo 440

YATO		
YT-38671	1/2" (12.7 mm)	10

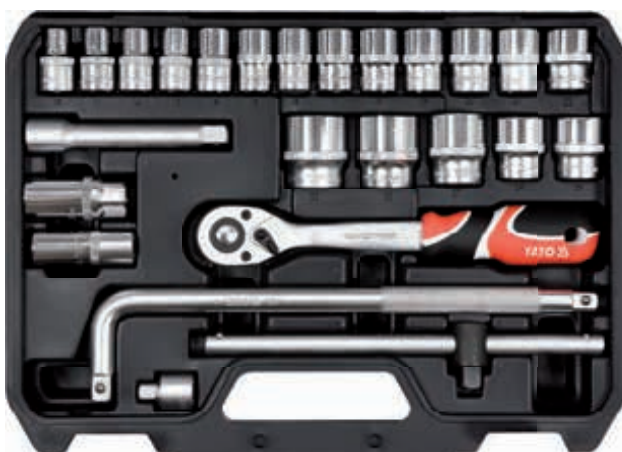

BMC & COLOR SLEEVE L SIZE



25
PCS
CrV
6140

- 1/2" (12.7 mm): 10, 11, 12, 13, 14, 15, 16, 17, 18, 19, 20, 21, 22, 23, 24 mm (L=38 mm); 27, 30, 32 mm (L=42 mm);
- 1/2" (12.7 mm): (127 mm); CrV 50BV30;
- 1/2" (12.7 mm): 16, 21 mm; CrV 50BV30;
- 1/2" (12.7 mm): (255 mm); CrV 50BV30;
- 1/2" (12.7 mm): (255 mm);
- 1/2" (12.7 mm): (317 mm); CrV 50BV30;
- 1/2" (12.7 mm) (F) x 3/8" (9.5 mm) (M); CrV 50BV30

YATO		
YT-38741	1/2" (12.7 mm)	2

GB Tool set
D Sechskant-Steckschlüssel-Satz
PL Zestaw narzędziowy

RUS Набор инструмента
CZ Sada nástrčných klíčů a ráčny
H Dugókulcs készlet racsnis hajtókkal

RO Rotrusa chei tubulare cu antrenor
F Coffret d'outillage
I Set di utensili

E Juego de herramientas
CN 套筒扳手组套

1/2"
12.5mm
1/4"
6.3mm

CrV
50BV30
S2

72T
AS-DRIVE



BMC & COLOR SLEEVE L SIZE



77
PCS
CrV
6150
CrMo
440

- 1/2" (12.7 mm): 10, 11, 12, 13, 14, 15, 17, 19, 22, 24 mm (L=38 mm); 27, 30, 32 mm (L=42 mm);
- 1/4" (6.3 mm): 4, 5, 6, 7, 8, 9, 10, 11, 12 mm (L=25 mm); CrV 50BV30;
- 1/2" (12.7 mm): (127, 254 mm);
- 1/4" (6.3 mm): (76, 101.6 mm); CrV 50BV30;
- 1/2" (12.7 mm), 1/4" (6.3 mm); CrV 50BV30;
- 1/2" (12.7 mm): 16, 21 mm; CrV 50BV30;
- 1/2" (12.7 mm): (255 mm);
- 1/4" (6.3 mm): (155 mm); 72T; CrMo 440;
- 1/4" (6.3 mm) x 1/4" (6.3 mm); CrV 50BV30;
- 1/4" (6.3 mm) x 1/4" (6.3 mm); CrV 50BV30;
- 1/4" (6.3 mm): 3, 4, 5.5, 7 mm (L=25 mm); AISI S2;
- 1/4" (6.3 mm): PH0, PH1, PH2, PH3 (L=25 mm); AISI S2;
- 1/4" (6.3 mm): PZ1, PZ2, PZ3 (L=25 mm); AISI S2;
- 1/4" (6.3 mm): T10, T15, T20, T25, T30 (L=25 mm); AISI S2;
- 1/4" (6.3 mm): 2, 3, 4, 5, 6 mm (L=25 mm); AISI S2;
- 7, 8, 9, 10, 11, 12, 13, 14, 15, 17, 19 mm; CrV;
- 8x9, 10x11, 12x13, 14x15 mm; CrV 50BV30;
- 1.5, 2, 2.5, 5, 6, 8, 10 mm; CrV 6150

YATO		
YT-38781	1/2" (12.7 mm)	1/4" (6.3 mm)
		2

GB Tool set
D Sechskant-Steckschlüssel-Satz
PL Zestaw narzędziowy
RUS Набор инструмента

CZ Sada nástrčných klíčů a ráčny
H Dugókulcs készlet racsnis hajtókarral
RO Roturasa chei tubulare cu antrenor
F Coffret d'outillage

I Set di utensili
E Juego de herramientas
CN 套筒扳手组套

1/2" 12.5mm
1/4" 6.3mm
CrV 50BV30 S2
72T AS-DRIVE

BMC & COLOR SLEEVE
XXXL SIZE



79 PCS CrV 6140 CrV 60 CrMo SK5

- 1/2" (12.7 mm): 10, 11, 12, 13, 14, 16, 17, 19, 22, 24, 26 mm (L=38 mm); 27, 30, 32 mm (L=42 mm);
- 1/4" (6.3 mm): 5, 6, 7, 8, 9, 10, 11, 12, 13 mm (L=25 mm); CrV 50BV30;
- 1/2" (12.7 mm): 10, 11, 12, 13, 14, 17, 19 mm (L=76 mm); CrV 50BV30;
- 1/2" (12.7 mm): (125 mm);
- 1/4" (6.3 mm): (50 mm); CrV 50BV30;
- 1/2" (12.7 mm); CrV 50BV30;
- 1/2" (12.7 mm): 16, 21 mm; CrV 50BV30;
- 1/2" (12.7 mm): (255 mm);
- 1/4" (6.3 mm): (155 mm); 72T; CrV 6140;
- 1/4" (6.3 mm): (150 mm); CrV 50BV30;
- 1/2" (12.7 mm): (457 mm);
- 6, 7, 8, 9, 10, 11, 12, 13, 14, 16, 17, 19, 22, 24 mm; CrV;
- 2.0x50, 2.4x75 mm; S2;
- 3.0x75, 4.0x100, 6.5x150, 8.0x150 mm; S2;
- PH0x75 mm; S2; PH1x75, PH2x100 mm; S2;
- 180 mm; 160 mm;
- 160, 200 mm; 250 mm;
- 300 g; 300 mm;
- 180 mm; CrMo; 120 mm; CrV 60;
- SK5; 2.5, 3, 4, 5, 6, 8, 10 mm; CrV

YATO	1/2" (12.7 mm)	1/4" (6.3 mm)	2
YT-38911			



BMC & COLOR SLEEVE
L SIZE



82 PCS CrV 6150 CrV 40 CrMo 440

- 1/2" (12.7 mm): 14, 15, 16, 17, 18, 19, 20, 22, 24 mm (L=38 mm); 27, 30, 32 mm (L=42 mm); 1/4" (6.3 mm): 4, 4.5, 5, 5.5, 6, 7, 8, 9, 10, 11, 12, 13, 14 mm (L=25 mm); CrV 50BV30;
- 1/2" (12.7 mm): (127, 254 mm); 1/4" (6.3 mm): (50.8, 101.6 mm); CrV 50BV30;
- 3/8" (9.5 mm) (F) x 1/2" (12.7 mm) (M); CrV 50BV30;
- 1/4" (6.3 mm): (150 mm); CrV 50BV30;
- 1/2" (12.7 mm); 1/4" (6.3 mm); CrV 50BV30;
- 1/2" (12.7 mm): 16, 21 mm; CrV 50BV30;
- 1/4" (6.3 mm): (152.4 mm); CrV 40;
- 1/2" (12.7 mm): (255 mm); 1/4" (6.3 mm): (155 mm); 72T; CrMo 440;
- 1/4" (6.3 mm): (150 mm); CrV 50BV30;
- 1/2" (12.7 mm) x 1/4" (6.3 mm); CrV 50BV30;
- 5/16" (7.9 mm): 8, 10, 12 mm (L=30 mm); AISI S2;
- 5/16" (7.9 mm): PH3, PH4 (L=30 mm); AISI S2;
- 5/16" (7.9 mm): PZ3, PZ4 (L=30 mm); AISI S2;
- 5/16" (7.9 mm): T40, T45, T50, T55 (L=30 mm); AISI S2;
- 5/16" (7.9 mm): 8, 10, 12, 14 mm (L=30 mm); AISI S2;
- 1/4" (6.3 mm): 4, 5, 5.7 mm (L=37 mm); AISI S2 / CrV 6150;
- 1/4" (6.3 mm): PH1, PH2 (L=37 mm); AISI S2 / CrV 6150;
- 1/4" (6.3 mm): PZ1, PZ2 (L=37 mm); AISI S2 / CrV 6150;
- 1/4" (6.3 mm): T8, T10, T15, T20, T25, T30 (L=37 mm); AISI S2 / CrV 6150;
- 1/4" (6.3 mm): 3, 4, 5, 6 mm (L=37 mm); AISI S2 / CrV 6150;
- 8, 10, 11, 12, 13, 14, 17, 19, 22 mm; CrV

YATO	1/2" (12.7 mm)	1/4" (6.3 mm)	2
YT-12691			

GB Tool set
D Sechskant-Steckschlüssel-Satz
PL Zestaw narzędziowy
RUS Набор инструмента

CZ Sada nástrčných kľúčů a ráčny
H Dugókulcs készlet racsnis hajtókarral
RO Rotrusa chei tubulare cu antrenor
F Coffret d'outillage

I Set di utensili
E Juego de herramientas
CN 套筒扳手套

BMC & COLOR SLEEVE
 L SIZE



1/2"	1/4"
12.5mm	6.3mm
CrV 50BV30	S2
72T	AS-DRIVE

2



94 PCS	CrV 6150	CrV 40	CrMo 440
-----------	-------------	-----------	-------------

1/2" (12.7 mm): 10, 11, 12, 13, 14, 15, 16, 17, 18, 19, 20, 21, 22, 23, 24 mm (L=38 mm); 27, 30, 32 mm (L=42 mm); 1/4" (6.3 mm): 4, 4.5, 5, 5.5, 6, 7, 8, 9, 10, 11, 12, 13, 14 mm (L=25 mm); CrV 50BV30: 1/2" (12.7 mm): 14, 15, 17, 19 mm (L=76 mm), 1/4" (6.3 mm): 6, 7, 8, 9, 10, 11, 12, 13 mm (L=50 mm); CrV 50BV30: 1/2" (12.7 mm): (127, 254 mm), 1/4" (6.3 mm): (50.8, 101.6 mm); CrV 50BV30: 3/8" (9.5 mm) (F) x 1/2" (12.7 mm) (M); CrV 50BV30: 1/4" (6.3 mm): (150 mm); CrV 50BV30: 1/2" (12.7 mm), 1/4" (6.3 mm); CrV 50BV30: 1/2" (12.7 mm): 16, 21 mm; CrV 50BV30: 1/4" (6.3 mm); (152.4 mm); CrV 40: 1/2" (12.7 mm); (255 mm), 1/4" (6.3 mm); (155 mm); 72T; CrMo 440: 1/4" (6.3 mm); (150 mm); CrV 50BV30: 1/2" (12.7 mm) x 5/16" (7.9 mm); CrV 50BV30: 1/4" (6.3 mm) x 1/4" (6.3 mm); 8, 10, 12 mm (L=30 mm); AISI S2: 5/16" (7.9 mm); PH3, PH4 (L=30 mm); AISI S2: 5/16" (7.9 mm); PZ3, PZ4 (L=30 mm); AISI S2: 5/16" (7.9 mm); T40, T45, T50, T55 (L=30 mm); AISI S2: 5/16" (7.9 mm); 8, 10, 12, 14 mm (L=30 mm); AISI S2: 1/4" (6.3 mm); 4, 5, 5, 7 mm (L=37 mm); AISI S2 / CrV 6150: 1/4" (6.3 mm); PH1, PH2 (L=37 mm); AISI S2 / CrV 6150: 1/4" (6.3 mm); PZ1, PZ2 (L=37 mm); AISI S2 / CrV 6150: 1/4" (6.3 mm); T8, T10, T15, T20, T25, T30 (L=37 mm); AISI S2 / CrV 6150: 1/4" (6.3 mm); 3, 4, 5, 6 mm (L=37 mm); AISI S2 / CrV 6150: 1.5, 2, 2.5 mm; CrV 6150

YATO			
YT-12681	1/2" (12.7 mm)	1/4" (6.3 mm)	2



100 PCS	CrV 6140
------------	-------------

3.6 V 1300 mAh Li-Ion	Li-Ion
230 min ¹	3.0 Nm
LED MOTOR INDICATOR WISZACZNIK OSWIETLENIE OBSZARU PRACY	WORKING AREA LIGHT OSWIETLENIE OBSZARU PRACY

L_{wa} = 61.7 ± 3.0 dB;
 L_{pa} = 72.7 ± 3.0 dB;
 ah = 0.39 ± 1.5 m/s²

1/2" (12.7 mm): 10, 11, 12, 13, 14, 15, 16, 17, 18, 19, 20, 21, 22, 23, 24 mm (L=38 mm); 27, 30, 32 mm (L=42 mm); 1/4" (6.3 mm): 4, 4.5, 5, 5.5, 6, 7, 8, 9, 10, 11, 12, 13, 14 mm (L=25 mm); CrV 50BV30: 1/4" (6.3 mm): 6, 7, 8, 9, 10, 11, 12, 13 mm (L=50 mm); CrV 50BV30: 1/2" (12.7 mm): (127, 254 mm), 1/4" (6.3 mm): (50.8, 101.6 mm); CrV 50BV30: 3/8" (9.5 mm) (F) x 1/2" (12.7 mm) (M); CrV 50BV30: 1/4" (6.3 mm): (150 mm); CrV 6140: 1/2" (12.7 mm), 1/4" (6.3 mm); CrV 50BV30: 1/2" (12.7 mm): 16, 21 mm; CrV 50BV30: 1/4" (6.3 mm); (152.4 mm); CrV 50BV30: 1/2" (12.7 mm); (255 mm), 1/4" (6.3 mm); 72T; CrV 6140: 1/4" (6.3 mm); (150 mm); CrV 50BV30: 1/2" (12.7 mm) x 5/16" (7.9 mm); CrV 6140: 1/4" (6.3 mm) x 1/4" (6.3 mm); 8, 10, 12 mm (L=30 mm); AISI S2: 5/16" (7.9 mm); PH3, PH4 (L=30 mm); AISI S2: 5/16" (7.9 mm); PZ3, PZ4 (L=30 mm); AISI S2: 5/16" (7.9 mm); T40, T45, T50, T55 (L=30 mm); AISI S2: 5/16" (7.9 mm); 8, 10, 12, 14 mm (L=30 mm); AISI S2: 1/4" (6.3 mm); 4 mm (L=50 mm); AISI S2, 1/4" (6.3 mm): 3, 4, 5, 5, 7 mm (L=25 mm); AISI S2: 1/4" (6.3 mm); PH1 (L=50 mm); AISI S2, 1/4" (6.3 mm); PH0, PH1, PH2, PH3 (L=25 mm); AISI S2: 1/4" (6.3 mm); PZ1, PZ2, PZ3 (L=25 mm); AISI S2: 1/4" (6.3 mm); T10, T15, T20, T25, T30 (L=25 mm); AISI S2: 1/4" (6.3 mm); 2, 3, 4, 5, 6 mm (L=25 mm); AISI S2: 3.6V; 5V 300mA; 1.5, 2.0, 2.5 mm; CrV 6150

YATO			
YT-12685	1/2" (12.7 mm)	1/4" (6.3 mm)	2

GB Tool set
D Sechskant-Steckschlüssel-Satz
PL Zestaw narzędziowy
RUS Набор инструмента

CZ Sada nástrčných klíčů a ráčny
H Dugókulcs készlet racsnis hajtókarral
RO Rotrușa chei tubulare cu antrenor
F Coffret d'outillage

I Set di utensili
E Juego de herramientas
CN 套筒扳手组套

1/2" 12.5mm	1/4" 6.3mm
CrV 50BV30	CrV 6150
CrMo 440	S2
72T	AS-DRIVE



108
PCS

CrV
40

BMC & COLOR SLEEVE
L SIZE



1/2" (12.7 mm): 10, 11, 12, 13, 14, 15, 16, 17, 18, 19, 20, 21, 22, 24 mm (L=38 mm); 27, 30, 32 mm (L=42 mm), 1/4" (6.3 mm): 4, 4.5, 5, 5.5, 6, 7, 8, 9, 10, 11, 12, 13, 14 mm (L=25 mm); CrV 50BV30: 1/2" (12.7 mm): 14, 15, 17, 19, 22 mm (L=76 mm), 1/4" (6.3 mm): 6, 7, 8, 9, 10, 11, 12, 13 mm (L=50 mm); CrV 50BV30: 1/2" (12.7 mm): E10, E11, E12, E14, E16, E18, E20, E24, 1/4" (6.3 mm): E4, E5, E6, E7, E8; CrV 6150: 1/2" (12.7 mm): (127, 254 mm), 1/4" (6.3 mm): (50.8, 101.6 mm); CrV 50BV30: 3/8" (9.5 mm) (F) x 1/2" (12.7 mm) (M); CrV 50BV30: 1/2" (12.7 mm), 1/4" (6.3 mm); CrV 50BV30: 1/2" (12.7 mm): 16, 21 mm; CrV 50BV30: 1/4" (6.3 mm); (152.4 mm); CrV 40: 1/2" (12.7 mm); (255 mm), 1/4" (6.3 mm); (155 mm); 72T; CrMo 440: 1/4" (6.3 mm); (150 mm); CrV 50BV30: 1/2" (12.7 mm) x 5/16" (7.9 mm); CrV 50BV30: 5/16" (7.9 mm): 8, 10, 12 mm (L=30 mm); AISI S2: 5/16" (7.9 mm): PH3, PH4 (L=30 mm); AISI S2: 5/16" (7.9 mm): PZ3, PZ4 (L=30 mm); AISI S2: 5/16" (7.9 mm): T40, T45, T50, T55, T60 (L=30 mm); AISI S2: 5/16" (7.9 mm): 7, 8, 10, 12, 14 mm (L=30 mm); AISI S2: 1/4" (6.3 mm): 4, 5, 5.5, 6.5 mm (L=37 mm); AISI S2 / CrV 6150: 1/4" (6.3 mm): PH1, PH2 (L=37 mm); AISI S2 / CrV 6150: 1/4" (6.3 mm): PZ1, PZ2 (L=37 mm); AISI S2 / CrV 6150: 1/4" (6.3 mm): T8, T10, T15, T20, T25, T27, T30 (L=37 mm); AISI S2 / CrV 6150: 1/4" (6.3 mm): 3, 4, 5, 6 mm (L=37 mm); AISI S2 / CrV 6150: 1.5, 2, 2.5 mm; CrV 6150

YATO	1/2" (12.7 mm)	1/4" (6.3 mm)	2
YT-38791			



109
PCS

CrV
6140

BMC & COLOR SLEEVE
XXL SIZE



1/2" (12.7 mm): 12, 13, 14, 15, 16, 17, 18, 19, 20, 21, 22, 24 mm (L=38 mm); 27, 30, 32 mm (L=42 mm), 1/4" (6.3 mm): 4, 4.5, 5, 5.5, 6, 7, 8, 9, 10, 11, 12, 13, 14 mm (L=25 mm); CrV 50BV30: 1/2" (12.7 mm): 10, 12, 13, 14, 17, 19 mm (L=76 mm), 1/4" (6.3 mm): 4, 5, 6, 7, 8, 9 mm (L=50 mm); CrV 50BV30: 1/2" (12.7 mm): E10, E12, E14, E16, E18, E20, E22, E24; CrV 6150: 1/2" (12.7 mm); (254 mm), 1/4" (6.3 mm): (152.4 mm); CrV 50BV30: 3/8" (9.5 mm) (F) x 1/2" (12.7 mm) (M), 3/8" (9.5 mm) (F) x 1/4" (6.3 mm) (M); CrV 50BV30: 1/2" (12.7 mm), 1/4" (6.3 mm); CrV 50BV30: 1/2" (12.7 mm): 16, 21 mm; CrV 50BV30: 1/2" (12.7 mm); (255 mm), 1/4" (6.3 mm); (155 mm); 72T; CrMo 440: 1/4" (6.3 mm); (150 mm); CrV 50BV30: 1/4" (6.3 mm): 4, 5.5, 6.5 mm (L=37 mm); AISI S2 / CrV 6150: 1/4" (6.3 mm): PH1, PH2, PH3 (L=37 mm); AISI S2 / CrV 6150: 1/4" (6.3 mm): PZ2, PZ3 (L=37 mm); AISI S2 / CrV 6150: 1/4" (6.3 mm): T8, T10, T15, T20, T25 (L=37 mm); AISI S2 / CrV 6150: 1/4" (6.3 mm): T10, T15, T20, T25, T40 (L=37 mm); AISI S2 / CrV 6150: 1/4" (6.3 mm): 3, 4, 5, 6 mm (L=37 mm); AISI S2 / CrV 6150: 8, 9, 10, 11, 12, 13, 14, 15, 16, 17, 18, 19 mm; CrV: 8x9, 10x11, 12x13, 14x15 mm; CrV 50BV30: 8x10, 12x13, 17x19 mm; CrV 6140: 3x75, 4x100, 6x150, PH1x75, PH2x100, PH3x150 mm; S2: 180 mm; 160 mm; 300 g

YATO	1/2" (12.7 mm)	1/4" (6.3 mm)	2
YT-38891			

GB Tool set
D Sechskant-Steckschlüssel-Satz
PL Zestaw narzędziowy
RUS Набор инструмента

CZ Sada nástrčných kľúčů a ráčny
H Dugókulcs készlet racsnis hajtókarral
RO Rotrusa chei tubulare cu antrenor
F Coffret d'outillage

I Set di utensili
E Juego de herramientas
CN 套筒扳手组套

BMC & COLOR SLEEVE
 XXL SIZE



122 PCS	1/2" 12.5mm	1/4" 6.3mm
CrV 50BV30	CrV 6150	
CrMo 440	S2	
72T	AS-DRIVE	



1/2" (12.7 mm): 12, 13, 14, 15, 16, 17, 18, 19, 20, 21, 22, 24 mm (L=38 mm); 27, 30, 32 mm (L=42 mm), 1/4" (6.3 mm): 4, 4.5, 5, 5.5, 6, 7, 8, 9, 10, 11, 12, 13, 14 mm (L=25 mm); CrV 50BV30: 1/2" (12.7 mm): 10, 12, 13, 14, 17, 19 mm (L=76 mm), 1/4" (6.3 mm): 4, 5, 6, 7, 8, 9 mm (L=50 mm); CrV 50BV30: 1/2" (12.7 mm): E10, E12, E14, E16, E18, E20, E22, E24; CrV 6150: 1/2" (12.7 mm): (254 mm), 1/4" (6.3 mm): (152.4 mm); CrV 50BV30: 3/8" (9.5 mm) (F) x 1/2" (12.7 mm) (M), 3/8" (9.5 mm) (F) x 1/4" (6.3 mm) (M); CrV 50BV30: 1/2" (12.7 mm), 1/4" (6.3 mm); CrV 50BV30: 1/2" (12.7 mm): 16, 21 mm; CrV 50BV30: 1/2" (12.7 mm): (255 mm), 1/4" (6.3 mm): (155 mm); 72T; CrMo 440: 1/4" (6.3 mm): (150 mm); CrV 50BV30: 1/4" (6.3 mm) x 1/4" (6.3 mm); CrV 50BV30: 1/4" (6.3 mm): 3, 4, 5, 6 mm (L=25 mm); AISI S2: 1/4" (6.3 mm): PH0, PH1, PH2 (L=25 mm); AISI S2: 1/4" (6.3 mm): PZ0, PZ1, PZ2 (L=25 mm); AISI S2: 1/4" (6.3 mm): 4, 5, 5.5, 6 mm (L=37 mm); AISI S2 / CrV 6150: 1/4" (6.3 mm): PH1, PH2, PH3 (L=37 mm); AISI S2 / CrV 6150: 1/4" (6.3 mm): PZ2, PZ3 (L=37 mm); AISI S2 / CrV 6150: 1/4" (6.3 mm): T8, T10, T15, T20, T25 (L=37 mm); AISI S2 / CrV 6150: 1/4" (6.3 mm): T10, T15, T20, T25, T40 (L=37 mm); AISI S2 / CrV 6150: 1/4" (6.3 mm): 3, 4, 5, 6 mm (L=37 mm); AISI S2 / CrV 6150: 8, 9, 10, 11, 12, 13, 14, 15, 16, 17, 18, 19 mm; CrV: 4x100, 6x150, PH2x100, PH3x150 mm; S2: 180 mm; 160 mm; 160 mm; 250 mm; CrV: 300 g; 2, 2.5, 3, 4, 5, 6, 7, 8, 10 mm; CrV 6150

YATO	1/2" (12.7 mm)	1/4" (6.3 mm)	2
YT-38901			

GB Tool set
D Sechskant-Steckschlüssel-Satz
PL Zestaw narzędziowy
RUS Набор инструмента

CZ Sada nástrčných kľúčů a ráčny
H Dugókulcs készlet racsnis hajtókarral
RO Rotrusa chei tubulare cu antrenor
F Coffret d'outillage

I Set di utensili
E Juego de herramientas
CN 套筒扳手组套

BMC & COLOR SLEEVE
 XL SIZE



111 PCS	1/2" 12.5mm	3/8" 10mm	1/4" 6.3mm
CrV 50BV30	CrV 6150	CrMo 440	
S2	72T	AS-DRIVE	



1/2" (12.7 mm): 14, 15, 16, 17, 18, 19, 20, 21, 22, 23, 24 mm (L=38 mm); 27, 30, 32 mm (L=42 mm), 3/8" (9.5 mm): 9, 10, 11, 12, 13, 14, 15, 16 mm (L=28 mm); 17, 18, 19 mm (L=30 mm), 1/4" (6.3 mm): 3.5, 4, 4.5, 5, 5.5, 6, 7, 8, 9, 10, 11, 12, 13 mm (L=25 mm); CrV 50BV30: 1/2" (12.7 mm): (127, 254 mm), 3/8" (9.5 mm): (76, 152.4 mm), 1/4" (6.3 mm): (50.8, 152.4 mm); CrV 50BV30: 3/8" (9.5 mm) (F) x 1/2" (12.7 mm) (M), 1/2" (12.7 mm) (F) x 3/8" (9.5 mm) (M), 3/8" (9.5 mm) (F) x 1/4" (6.3 mm) (M); CrV 50BV30: 1/2" (12.7 mm), 3/8" (9.5 mm), 1/4" (6.3 mm); CrV 50BV30: 1/2" (12.7 mm): 16, 21 mm, 3/8" (9.5 mm): 16, 21 mm; CrV 50BV30: 1/2" (12.7 mm): (255 mm), 3/8" (9.5 mm): (200 mm), 1/4" (6.3 mm): (155 mm); 72T; CrMo 440: 1/4" (6.3 mm): (150 mm); CrV 50BV30: 1/2" (12.7 mm) x 5/16" (7.9 mm), 3/8" (9.5 mm) x 5/16" (7.9 mm); CrV 50BV30: 5/16" (7.9 mm): 6, 6.5, 8 mm (L=30 mm); AISI S2: 5/16" (7.9 mm): PH2, PH3 (L=30 mm); AISI S2: 5/16" (7.9 mm): PZ2, PZ3 (L=30 mm); AISI S2: 5/16" (7.9 mm): T27, T30, T35, T40, T45 (L=30 mm); AISI S2: 5/16" (7.9 mm): 5.5, 6, 6.5 mm (L=30 mm); AISI S2: 1/4" (6.3 mm): 4, 5, 5.5, 6 mm (L=37 mm); AISI S2 / CrV 6150: 1/4" (6.3 mm): PH1, PH2 (L=37 mm); AISI S2 / CrV 6150: 1/4" (6.3 mm): PZ1, PZ2 (L=37 mm); AISI S2 / CrV 6150: 1/4" (6.3 mm): T8, T10, T15, T20, T25 (L=37 mm); AISI S2 / CrV 6150: 1/4" (6.3 mm): T10, T15, T20, T25, T40 (L=37 mm); AISI S2 / CrV 6150: 1/4" (6.3 mm): 3, 4, 5, 6 mm (L=37 mm); AISI S2 / CrV 6150: 8, 9, 10, 11, 12, 13, 14, 15, 16, 17, 18, 19 mm; CrV: 1.5, 2, 2.5 mm; CrV 6150

YATO	1/2" (12.7 mm)	3/8" (9.5 mm)	1/4" (6.3 mm)	2
YT-38831				

GB Tool set
D Sechskant-Steckschlüssel-Satz
PL Zestaw narzędziowy
RUS Набор инструмента

CZ Sada nástrčných klíčů a ráčny
H Dugókulcs készlet racsnis hajtókarral
RO Rotrusa chei tubulare cu antrenor
F Coffret d'outillage

I Set di utensili
E Juego de herramientas
CN 套筒扳手组套

BMC & COLOR SLEEVE
XL SIZE



1/2" 12.5mm	3/8" 10mm	1/4" 6.3mm
CrV 50BV30	CrV 6150	S2
72T	AS-DRIVE	

2

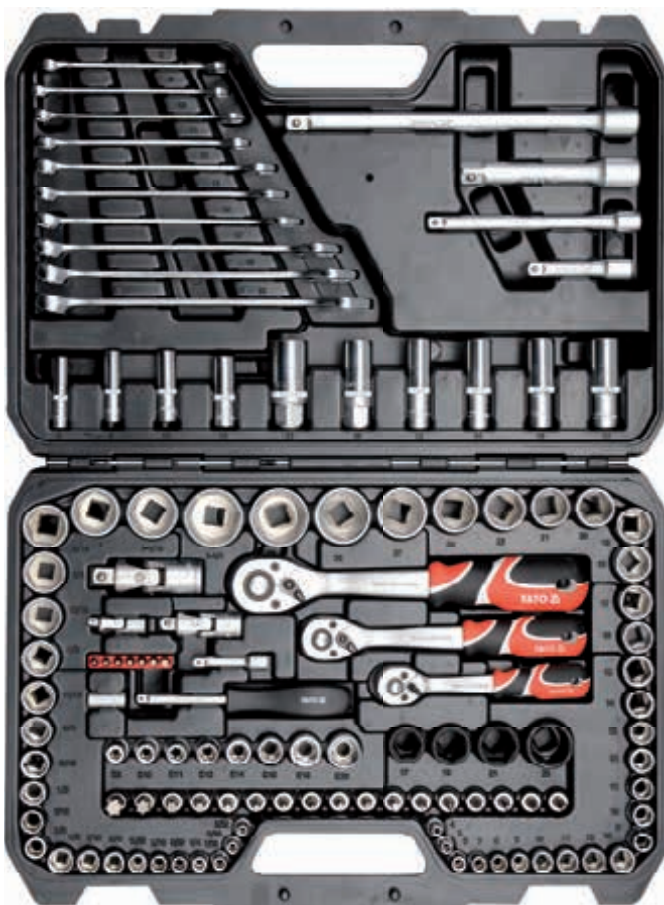

120
PCS

METRIC
& S.A.E.

CrMo
440

1/2" (12.7 mm): 20, 21, 22, 24 mm (L=38 mm); 27, 30, 32 mm (L=42 mm), 3/8" (9.5 mm): 9, 10, 11, 12, 13, 14, 15, 16 mm (L=28 mm); 17, 18, 19 mm (L=30 mm), 1/4" (6.3 mm): 4, 5, 6, 7, 8, 9, 10, 11, 12, 13 mm (L=25 mm); CrV 50BV30: □ 3/8" (9.5 mm); 13, 14, 15, 17 mm (L=63 mm), 1/4" (6.3 mm): 8, 9, 10, 12 mm (L=50 mm); CrV 50BV30: □ 1/2" (12.7 mm) x 15/16" (23.8 mm), 1/2" (12.7 mm) x 1" (25.4 mm), 1/2" (12.7 mm) x 1-1/16" (27.0 mm), 1/2" (12.7 mm) x 1-1/4" (31.8 mm), 3/8" (9.5 mm) x 3/8" (9.5 mm), 3/8" (9.5 mm) x 7/16" (11.1 mm), 3/8" (9.5 mm) x 1/2" (12.7 mm), 3/8" (9.5 mm) x 9/16" (14.3 mm), 3/8" (9.5 mm) x 5/8" (15.9 mm), 3/8" (9.5 mm) x 11/16" (17.5 mm), 3/8" (9.5 mm) x 3/4" (19.0 mm), 3/8" (9.5 mm) x 13/16" (20.6 mm), 3/8" (9.5 mm) x 7/8" (22.2 mm), 1/4" (6.3 mm) x 5/32" (4.0 mm), 1/4" (6.3 mm) x 3/16" (4.8 mm), 1/4" (6.3 mm) x 7/32" (5.6 mm), 1/4" (6.3 mm) x 1/4" (6.3 mm), 1/4" (6.3 mm) x 9/32" (7.1 mm), 1/4" (6.3 mm) x 5/16" (7.9 mm), 1/4" (6.3 mm) x 11/32" (8.7 mm), 1/4" (6.3 mm) x 3/8" (9.5 mm), 1/4" (6.3 mm) x 7/16" (11.1 mm), 1/4" (6.3 mm) x 1/2" (12.7 mm); CrV 50BV30: □ 1/2" (12.7 mm): 17, 19, 21, 23 mm; CrV 50BV30: □ 3/8" (9.5 mm): E8, E10, E11, E12, E14, E16, E18, E20; CrV 6150: □ 1/2" (12.7 mm): (127, 254 mm), 3/8" (9.5 mm): (76, 152.4 mm), 1/4" (6.3 mm): (50.8 mm); CrV 50BV30: □ 1/2" (12.7 mm), 3/8" (9.5 mm), 1/4" (6.3 mm); CrV 50BV30: □ 3/8" (9.5 mm): 16, 21 mm; CrV 50BV30: □ 1/2" (12.7 mm): (255 mm), 3/8" (9.5 mm): (200 mm), 1/4" (6.3 mm): (155 mm); 72T; CrMo 440: □ 1/4" (6.3 mm): (150 mm); CrV 50BV30: □ 1/4" (6.3 mm) x 1/4" (6.3 mm); CrV 50BV30: □ 1/4" (6.3 mm): T10, T15, T20, T25, T27, T30, T40 (L=25 mm); AISI S2: □ 3/8" (9.5 mm): 5.5, 6.5 mm (L=50 mm); AISI S2 / CrV 6150: □ 3/8" (9.5 mm): PH1, PH2 (L=50 mm); AISI S2 / CrV 6150: □ 3/8" (9.5 mm): PZ1, PZ2 (L=50 mm); AISI S2 / CrV 6150: □ 3/8" (9.5 mm): T20, T30, T40, T45, T50, T55, T60 (L=50 mm); AISI S2 / CrV 6150: □ 3/8" (9.5 mm): 3, 4, 5, 6 mm (L=50 mm); AISI S2 / CrV 6150: □ 8, 9, 10, 11, 12, 13, 14, 17, 18, 19 mm; CrV

YATO	□	□	□	□
YT-38801	1/2" (12.7 mm)	3/8" (9.5 mm)	1/4" (6.3 mm)	2

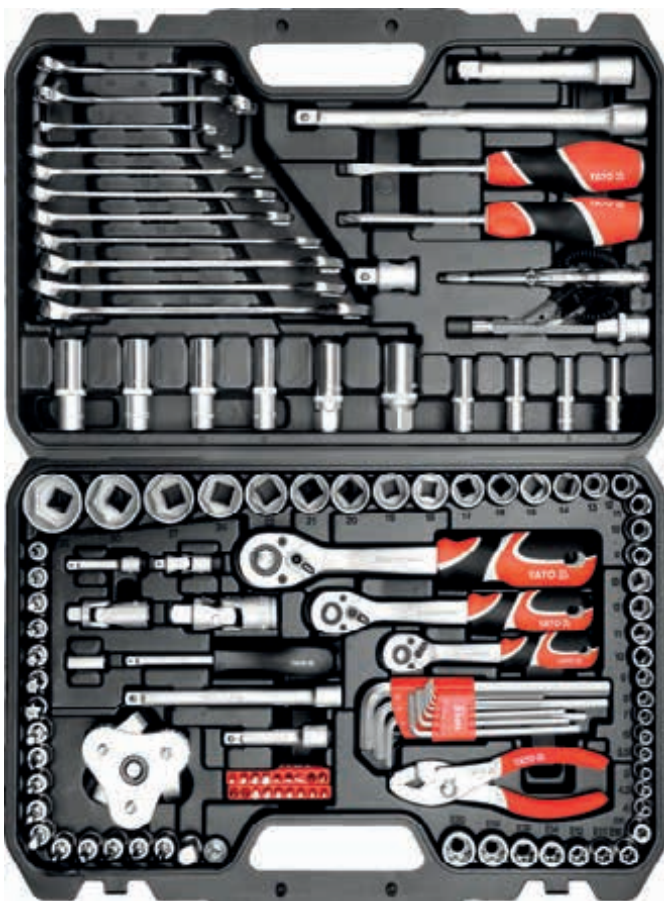

126
PCS

CrV
6140

1/2" (12.7 mm): 20, 21, 22, 24 mm (L=38 mm); 27, 30, 32 mm (L=42 mm), 3/8" (9.5 mm): 9, 10, 11, 12, 13, 14, 15, 16 mm (L=28 mm); 17, 18, 19 mm (L=30 mm), 1/4" (6.3 mm): 4, 4.5, 5, 5.5, 6, 7, 8, 9, 10, 11, 12, 13 mm (L=25 mm); CrV 50BV30: □ 3/8" (9.5 mm): 13, 14, 15, 17 mm (L=63 mm), 1/4" (6.3 mm): 8, 9, 10, 12 (L=50 mm); CrV 50BV30: □ 3/8" (9.5 mm): E8, E10, E11, E12, E14, E16, E18, E20; CrV 6150: □ 1/2" (12.7 mm): (127, 254 mm), 3/8" (9.5 mm): (76, 152.4 mm), 1/4" (6.3 mm): (50.8 mm); CrV 50BV30: □ 3/8" (9.5 mm) (F) x 1/2" (12.7 mm) (M); CrV 50BV30: □ 1/2" (12.7 mm), 3/8" (9.5 mm), 1/4" (6.3 mm); CrV 50BV30: □ 3/8" (9.5 mm): 16, 21 mm; CrV 50BV30: □ 1/2" (12.7 mm): (255 mm), 3/8" (9.5 mm): (200 mm), 1/4" (6.3 mm): (155 mm); 72T; CrV 6140: □ 1/4" (6.3 mm): (150 mm); CrV 50BV30: □ 1/2" (12.7 mm) (F) x 3/8" (9.5 mm) (M), 3/8" (9.5 mm) (F) x 1/2" (12.7 mm) (M), 3/8" (9.5 mm) (F) x 1/4" (6.3 mm) (M); CrV 50BV30: □ 1/4" (6.3 mm) x 1/4" (6.3 mm); CrV 6140: □ 1/4" (6.3 mm): 4, 5, 6.5 mm (L=25 mm); AISI S2: □ 1/4" (6.3 mm): PH1, PH3 (L=25 mm); AISI S2: □ 1/4" (6.3 mm): PZ1, PZ2 (L=25 mm); AISI S2: □ 1/4" (6.3 mm): T10, T15, T20, T25, T27, T30, T40 (L=25 mm); AISI S2: □ 1/4" (6.3 mm): 3, 4, 5, 6 mm (L=50 mm); AISI S2: □ 3/8" (9.5 mm): 5.5, 6.5 mm (L=50 mm); AISI S2 / CrV 6150: □ 3/8" (9.5 mm): PH1, 2xPH2 (L=50 mm); AISI S2 / CrV 6150: □ 3/8" (9.5 mm): T20, T30, T40 (L=50 mm); AISI S2 / CrV 6150: □ 3/8" (9.5 mm): T45, T50, T55, T60 (L=50 mm); AISI S2 / CrV 6150: □ 3/8" (9.5 mm): 3, 4, 5, 6, 7 mm (L=50 mm); AISI S2 / CrV 6150: □ 1/2" (12.7 mm): M10 (L=100 mm); AISI S2 / CrV 6150: □ 8, 10, 12, 13, 14, 16, 17, 18, 19 mm; CrV: □ 8x10 mm, 11x12 mm; CrV 6140: □ 6x100 mm, PH2x100 mm; CrV 6150: □ 6-24 V; □ 1/2" (12.7 mm), 3/8" (9.5 mm): 63-120 mm; CrV: □ 1.5, 2, 2.5, 3, 4, 5, 6, 8, 10 mm; S2

YATO	□	□	□	□
YT-38875	1/2" (12.7 mm)	3/8" (9.5 mm)	1/4" (6.3 mm)	2

GB Tool set
D Sechskant-Steckschlüssel-Satz
PL Zestaw narzędziowy
RUS Набор инструмента

CZ Sada nástrčných klíčů a ráčny
H Dugókulcs készlet racsnis hajtókarral
RO Rotrusa chei tubulare cu antrenor
F Coffret d'outillage

I Set di utensili
E Juego de herramientas
CN 套筒扳手组套

1/2" 12.5mm	3/8" 10mm	1/4" 6.3mm
CrV 50BV30	CrV 6150	CrMo 440
S2	72T	AS-DRIVE

2



128
PCS

BMC & COLOR
SLEEVE
XL SIZE



1/2" (12.7 mm): 14, 15, 16, 17, 18, 19, 20, 21, 22, 24 mm (L=38 mm); 27, 30, 32 mm (L=42 mm); 3/8" (9.5 mm): 10, 11, 12, 13, 14, 15, 16 mm (L=28 mm); 17, 18 mm (L=30 mm); 1/4" (6.3 mm): 6, 7, 8, 9, 10, 11, 12, 13 mm (L=25 mm); CrV 50BV30: 1/2" (12.7 mm): 17, 18, 19, 22 mm (L=76 mm); 3/8" (9.5 mm): 8, 10, 12, 13, 14, 15 mm (L=63 mm); 1/4" (6.3 mm): 6, 7, 8, 10, 12, 13 mm (L=50 mm); CrV 50BV30: 1/2" (12.7 mm): 17, 19, 21, 22 mm; CrV 50BV30: 3/8" (9.5 mm): E8, E10, E11, E12, E14, E16; CrV 6150: 1/2" (12.7 mm): (127, 254 mm); 3/8" (9.5 mm): (152.4, 254 mm); 1/4" (6.3 mm): (50.8, 101.6 mm); CrV 50BV30: 3/8" (9.5 mm) (F) x 1/2" (12.7 mm) (M); CrV 50BV30: 1/2" (12.7 mm); 3/8" (9.5 mm); 1/4" (6.3 mm); CrV 50BV30: 1/2" (12.7 mm): 16, 21 mm; CrV 50BV30: 3/8" (9.5 mm): (198 mm); 1/4" (6.3 mm): (152.4 mm); CrV 50BV30: 1/2" (12.7 mm): (255 mm); 3/8" (9.5 mm): (200 mm); 1/4" (6.3 mm): (155 mm); 72T; CrMo 440: 1/4" (6.3 mm): (150 mm); CrV 50BV30: 1/2" (12.7 mm): (250 mm); CrV 50BV30: 3/8" (9.5 mm) x 5/16" (7.9 mm); CrV 50BV30: 1/2" (12.7 mm) x 3/8" (9.5 mm); 3/8" (9.5 mm) x 1/4" (6.3 mm); CrV 50BV30: 1/4" (6.3 mm) x 1/4" (6.3 mm); CrV 50BV30: 3/8" (9.5 mm): 5.5, 6.5 mm (L=70 mm); AISI S2: 3/8" (9.5 mm): PH1, PH2, PH3 (L=70 mm); AISI S2: 3/8" (9.5 mm): T20, T30, T40, T45, T50, T55 (L=70 mm); AISI S2: 3/8" (9.5 mm): 6, 7, 8, 10, 12 mm (L=70 mm); AISI S2: 1/4" (6.3 mm): PZ1, PZ2 (L=25 mm); AISI S2: 1/4" (6.3 mm): T8, T10 (L=25 mm); AISI S2: 1/4" (6.3 mm): 4.0, 5.5, 6.5 mm (L=37 mm); AISI S2 / CrV 6150: 1/4" (6.3 mm): PH1, PH2 (L=37 mm); AISI S2 / CrV 6150: 1/4" (6.3 mm): T8, T10, T15, T20, T25, T30, T40 (L=37 mm); AISI S2 / CrV 6150: 1/4" (6.3 mm): 3, 4, 5, 6 mm (L=37 mm); AISI S2 / CrV 6150: 8, 10, 12, 13, 14, 15, 16, 17, 18, 19 mm; CrV: 1.5, 2, 2.5 mm; CrV 6150

YATO	1/2" (12.7 mm)	3/8" (9.5 mm)	1/4" (6.3 mm)	2
YT-38872				



129
PCS

BMC & COLOR
SLEEVE
XXL SIZE



1/2" (12.7 mm): 12, 13, 14, 15, 16, 17, 18, 19, 20, 21, 22, 24 mm (L=38 mm); 27, 30, 32 mm (L=42 mm); 3/8" (9.5 mm): 10, 11, 12, 13, 14, 15, 16 mm (L=28 mm); 17, 18, 19 mm (L=30 mm); 1/4" (6.3 mm): 4, 4.5, 5, 5.5, 6, 7, 8, 9, 10, 11, 12, 13, 14 mm (L=25 mm); CrV 50BV30: 1/2" (12.7 mm): 10, 12, 13, 14, 17, 19 mm (L=76 mm); 1/4" (6.3 mm): 4, 5, 6, 7, 8, 9 mm (L=50 mm); CrV 50BV30: 1/2" (12.7 mm): 17, 19, 21, 23 mm; CrV 50BV30: 3/8" (9.5 mm): E8, E10, E11, E12, E14, E16, E18, E20; CrV 6150: 1/2" (12.7 mm): (127, 254 mm); 3/8" (9.5 mm): (76, 152.4 mm); 1/4" (6.3 mm): (50.8 mm); CrV 50BV30: 1/2" (12.7 mm); 3/8" (9.5 mm); 1/4" (6.3 mm); CrV 50BV30: 3/8" (9.5 mm): 16, 21 mm; CrV 50BV30: 1/2" (12.7 mm): (255 mm); 3/8" (9.5 mm): (200 mm); 1/4" (6.3 mm): (155 mm); 72T; CrMo 440: 1/4" (6.3 mm): (150 mm); CrV 50BV30: 3/8" (9.5 mm): 4, 5.5, 6.5 mm (L=50 mm); AISI S2 / CrV 6150: 3/8" (9.5 mm): PH1, PH2, PH3 (L=50 mm); AISI S2 / CrV 6150: 3/8" (9.5 mm): PZ1, PZ2, PZ3 (L=50 mm); AISI S2 / CrV 6150: 3/8" (9.5 mm): T20, T30, T40, T45, T50, T55, T60 (L=50 mm); AISI S2 / CrV 6150: 3/8" (9.5 mm): 3, 4, 5, 6, 8, 10 mm (L=50 mm); AISI S2 / CrV 6150: 8, 10, 11, 12, 13, 14, 15, 16, 17, 18, 19, 22 mm; CrV: 3x75, 4x100, 6x150, PH1x75, PH2x100, PH3x150 mm; S2: 160 mm; 160 mm; 160 mm; 1.5, 2, 2.5, 3, 4, 5, 6, 7, 8, 10 mm; CrV 6150

YATO	1/2" (12.7 mm)	3/8" (9.5 mm)	1/4" (6.3 mm)	2
YT-38881				

GB Tool set
D Sechskant-Steckschlüssel-Satz
PL Zestaw narzędziowy
RUS Набор инструмента

CZ Sada nástrčných klíčů a ráčny
H Dugókulcs készlet racsnis hajtókarral
RO Rotruasa chei tubulare cu antrenor
F Coffret d'outillage

I Set di utensili
E Juego de herramientas
CN 套筒扳手组套

1/2" 12.5mm	3/8" 10mm	1/4" 6.3mm	CrV 50BV30	CrV 6150
CrMo 440	S2	72T	AS-DRIVE	

2



150
PCS

METRIC & S.A.E.

CrV 6140

BMC & COLOR
SLEEVE
XXL SIZE



1/2" (12.7 mm): 20, 21, 22, 24 mm (L=38 mm); 27, 30, 32 mm (L=42 mm); 3/8" (9.5 mm): 9, 10, 11, 12, 13, 14, 15, 16 mm (L=28 mm); 17, 18, 19 mm (L=30 mm); 1/4" (6.3 mm): 4, 5, 6, 7, 8, 9, 10, 11, 12, 13 mm (L=25 mm); CrV 50BV30: 1/2" (12.7 mm): 10, 12, 13, 14, 17, 19 mm (L=76 mm); 3/8" (9.5 mm): 10, 11, 12, 13, 14, 15 mm (L=63 mm); 1/4" (6.3 mm): 4, 5, 6, 7, 8, 9 mm (L=50 mm); CrV 50BV30: 1/2" (12.7 mm) x 15/16" (23.8 mm); 1/2" (12.7 mm) x 1" (25.4 mm); 1/2" (12.7 mm) x 1-1/16" (27.0 mm); 1/2" (12.7 mm) x 1-1/4" (31.8 mm); 3/8" (9.5 mm) x 3/8" (9.5 mm); 3/8" (9.5 mm) x 7/16" (11.1 mm); 3/8" (9.5 mm) x 1/2" (12.7 mm); 3/8" (9.5 mm) x 9/16" (14.3 mm); 3/8" (9.5 mm) x 5/8" (15.9 mm); 3/8" (9.5 mm) x 11/16" (17.5 mm); 3/8" (9.5 mm) x 3/4" (19.0 mm); 3/8" (9.5 mm) x 13/16" (20.6 mm); 3/8" (9.5 mm) x 7/8" (22.2 mm); 1/4" (6.3 mm) x 5/32" (4.0 mm); 1/4" (6.3 mm) x 3/16" (4.8 mm); 1/4" (6.3 mm) x 7/32" (5.6 mm); 1/4" (6.3 mm) x 1/4" (6.3 mm); 1/4" (6.3 mm) x 9/32" (7.1 mm); 1/4" (6.3 mm) x 5/16" (7.9 mm); 1/4" (6.3 mm) x 11/32" (8.7 mm); 1/4" (6.3 mm) x 3/8" (9.5 mm); 1/4" (6.3 mm) x 7/16" (11.1 mm); 1/4" (6.3 mm) x 1/2" (12.7 mm); CrV 50BV30: 1/2" (12.7 mm): 17, 19, 21, 23 mm; CrV 50BV30: 3/8" (9.5 mm): E8, E10, E11, E12, E14, E16, E18, E20; CrV 6150: 1/2" (12.7 mm): (127, 254 mm); 3/8" (9.5 mm): (76, 152.4 mm); 1/4" (6.3 mm): (50.8 mm); CrV 50BV30: 1/2" (12.7 mm); 3/8" (9.5 mm); 1/4" (6.3 mm); CrV 50BV30: 3/8" (9.5 mm): 16, 21 mm; CrV 50BV30: 1/2" (12.7 mm); (255 mm); 3/8" (9.5 mm); (200 mm); 1/4" (6.3 mm); (155 mm); 72T; CrMo 440: 1/4" (6.3 mm); (150 mm); CrV 50BV30: 1/4" (6.3 mm) x 1/4" (6.3 mm); CrV 50BV30: 1/4" (6.3 mm); T10, T15, T20, T25, T27, T30, T40 (L=25 mm); AISI S2: 3/8" (9.5 mm): 4, 5, 5, 6, 5 mm (L=50 mm); AISI S2 / CrV 6150: 3/8" (9.5 mm): PH1, PH2, PH3 (L=50 mm); AISI S2 / CrV 6150: 3/8" (9.5 mm): PZ1, PZ2, PZ3 (L=50 mm); AISI S2 / CrV 6150: 3/8" (9.5 mm): T20, T30, T40, T45, T50, T55, T60 (L=50 mm); AISI S2 / CrV 6150: 3/8" (9.5 mm): 3, 4, 5, 6, 8, 10 mm (L=50 mm); AISI S2 / CrV 6150: 8, 9, 10, 11, 12, 13, 14, 15, 16, 17, 18, 19 mm; CrV: 8x10, 12x13, 17x19 mm; CrV 6140: 1.5, 2, 2.5, 3, 4, 5, 6, 7, 8, 10 mm; CrV 6150

YATO	1/2" (12.7 mm)	3/8" (9.5 mm)	1/4" (6.3 mm)	
YT-38811				2



173
PCS

CrV 40

BMC & COLOR
SLEEVE
XL SIZE



1/2" (12.7 mm): 10, 11, 12, 13, 14, 15, 16, 17, 18, 19, 20, 21, 22, 23, 24 mm (L=38 mm); 27, 30, 32 mm (L=42 mm); 3/8" (9.5 mm): 10, 11, 12, 13, 14, 15, 16 mm (L=28 mm); 17, 18, 19 mm (L=30 mm); 1/4" (6.3 mm): 4, 4.5, 5, 5.5, 6, 7, 8, 9, 10, 11, 12, 13, 14 mm (L=25 mm); CrV 50BV30: 1/2" (12.7 mm): 16, 17, 18, 19, 22 mm (L=76 mm); 3/8" (9.5 mm): 10, 11, 12, 13, 14, 15 mm (L=63 mm); 1/4" (6.3 mm): 4, 5, 6, 7, 8, 9, 10 mm (L=50 mm); CrV 50BV30: 1/2" (12.7 mm): E18, E20, E24, 3/8" (9.5 mm): E10, E11, E12, E14, E16, 1/4" (6.3 mm): E4, E5, E6, E7, E8; CrV 6150: 1/2" (12.7 mm): (127, 254 mm); 3/8" (9.5 mm): (152.4 mm); 1/4" (6.3 mm): (50.8, 101.6 mm); CrV 50BV30: 3/8" (9.5 mm) (F) x 1/2" (12.7 mm); CrV 50BV30: 1/2" (12.7 mm); 3/8" (9.5 mm); 1/4" (6.3 mm); CrV 50BV30: 1/2" (12.7 mm): 16, 21 mm; 3/8" (9.5 mm); 18 mm; CrV 50BV30: 1/4" (6.3 mm); CrV 40: 1/2" (12.7 mm); (255 mm); 3/8" (9.5 mm); (200 mm); 1/4" (6.3 mm); (155 mm); 72T; CrMo 440: 1/4" (6.3 mm); (150 mm); CrV 50BV30: 1/4" (6.3 mm) x 1/2" (12.7 mm) x 5/16" (7.9 mm); 3/8" (9.5 mm) x 5/16" (7.9 mm); CrV 50BV30: 1/4" (6.3 mm) x 1/4" (6.3 mm); CrV 50BV30: 5/16" (7.9 mm): 8, 10, 12 mm (L=30 mm); AISI S2: 5/16" (7.9 mm): PH3, PH4 (L=30 mm); AISI S2: 5/16" (7.9 mm): PZ3, PZ4 (L=30 mm); AISI S2: 5/16" (7.9 mm): T40, T45, T50, T55, T60, T70 (L=30 mm); AISI S2: 5/16" (7.9 mm): T40, T45, T50, T55, T60, T70 (L=30 mm); AISI S2: 5/16" (7.9 mm): 7, 8, 10, 12, 14 mm (L=30 mm); AISI S2: 1/4" (6.3 mm): T5, T6, T7 (L=25 mm); AISI S2: 1/4" (6.3 mm): T7, T10, T15, T20, T25, T27, T30, T40, T45 (L=25 mm); AISI S2: 1/4" (6.3 mm): M5, M6, M8 (L=25 mm); AISI S2: 1/4" (6.3 mm): RM5, RM6, RM7, RM8, RM9 (L=25 mm); AISI S2: 1/4" (6.3 mm): 4, 5, 5, 6, 5, 7 mm (L=37 mm); AISI S2 / CrV 6150: 1/4" (6.3 mm): PH0, PH1, PH2 (L=37 mm); AISI S2 / CrV 6150: 1/4" (6.3 mm): PZ0, PZ1, PZ2 (L=37 mm); AISI S2 / CrV 6150: 1/4" (6.3 mm): T8, T9, T10, T15, T20, T25, T27, T30 (L=37 mm); AISI S2 / CrV 6150: 1/4" (6.3 mm): T8, T9, T10, T15, T20, T25, T27, T30 (L=37 mm); AISI S2 / CrV 6150: 1/4" (6.3 mm): 3, 4, 5, 6 mm (L=37 mm); AISI S2 / CrV 6150: 1.25, 1.5, 2, 2.5, 3, 4, 5 mm; CrV 6150

YATO	1/2" (12.7 mm)	3/8" (9.5 mm)	1/4" (6.3 mm)	
YT-38931				2



GB Tool set
D Sechskant-Steckschlüssel-Satz
PL Zestaw narzędziowy
RUS Набор инструментов
CZ Sada nástrčných kľučí a ráčny
H Dugókulcs készlet
RO Rotrusa chei tubulare cu antrenor
F Coffret d'outillage
I Set di utensili
E Juego de herramientas
CN 套筒扳手组套

METAL CASE & COLOR SLEEVE



CrV 50BV30
CrV 6140
72T
AS-DRIVE



15 PCS 1/4" 6.3mm

1/4" (6.3 mm): 4, 5, 6, 7, 8, 9, 10, 12, 13 mm (L=25 mm); CrV 50BV30;
 1/4" (6.3 mm): (50.8, 152.4 mm); CrV 50BV30;
 1/4" (6.3 mm): CrV 50BV30;
 1/4" (6.3 mm): (127 mm); 72T; CrV 6140;
 1/4" (6.3 mm): (150 mm); CrV 50BV30;

YATO	○	
YT-14411	1/4" (6.3 mm)	10



23 PCS 1/4" 6.3mm

1/4" (6.3 mm): 4, 5, 6, 7, 8, 9, 10, 12, 13 mm (L=25 mm); CrV 50BV30;
 1/4" (6.3 mm): 4, 5, 6, 7, 8, 9, 10, 12, 13 mm (L=50 mm); CrV 50BV30;
 1/4" (6.3 mm): (50.8, 152.4 mm); CrV 50BV30;
 1/4" (6.3 mm): CrV 50BV30;
 1/4" (6.3 mm): (127 mm); 72T; CrV 6140;
 1/4" (6.3 mm): (150 mm); CrV 50BV30

YATO	○	
YT-14421	1/4" (6.3 mm)	10



15 PCS 3/8" 10mm

3/8" (9.5 mm): 10, 11, 12, 13, 14, 15 (L=28 mm);
 17, 19, 21, 22 mm (L=30 mm); CrV 50BV30;
 3/8" (9.5 mm): (76, 152.4 mm); CrV 50BV30;
 3/8" (9.5 mm): 16, 21 mm; CrV 50BV30;
 3/8" (9.5 mm): (200 mm); 72T; CrV 6140

YATO	○	
YT-38631	3/8" (9.5 mm)	10

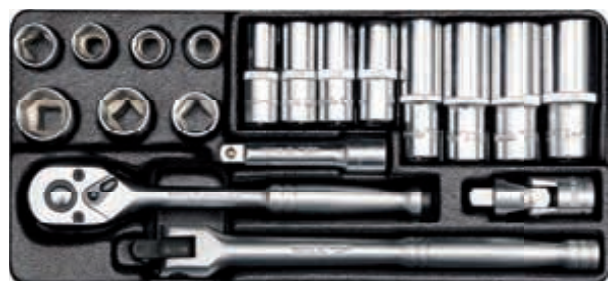

19 PCS 3/8" 10mm

3/8" (9.5 mm): 10, 11, 13, 14, 15 (L=28 mm); 17, 19 mm (L=30 mm); CrV 50BV30;
 3/8" (9.5 mm): 10, 11, 12, 13 mm (L=46 mm);
 14, 15, 17, 19 mm (L=63 mm); CrV 50BV30;
 3/8" (9.5 mm): (76 mm); CrV 50BV30; 3/8" (9.5 mm); CrV 50BV30;
 3/8" (9.5 mm): (200 mm); 72T; CrV 6140;
 3/8" (9.5 mm): (215 mm); CrV 50BV30

YATO	○	
YT-38641	3/8" (9.5 mm)	8



12 PCS 1/2" 12.5mm

1/2" (12.7 mm): 10, 11, 12, 13, 14, 15, 17, 19, 21, 24 mm (L=38 mm); CrV 50BV30;
 1/2" (12.7 mm): (125 mm); CrV 50BV30;
 1/2" (12.7 mm): (250 mm); 72T; CrV 6140

YATO	○	
YT-12621	1/2" (12.7 mm)	8

GB Tool set
D Sechskant-Steckschlüssel-Satz
PL Zestaw narzędziowy
RUS Набор инструмента

CZ Sada nástrčných klíčů a ráčny
H Dugókulcs készlet racsnis hajtókarral
RO Rotrusa chei tubulare cu antrenor
F Coffret d'outillage

I Set di utensili
E Juego de herramientas
CN 套筒扳手组套



METAL CASE & COLOR SLEEVE

1/2"
12.5mm
CrV
50BV30
CrV
6140
72T
AS-DRIVE

2

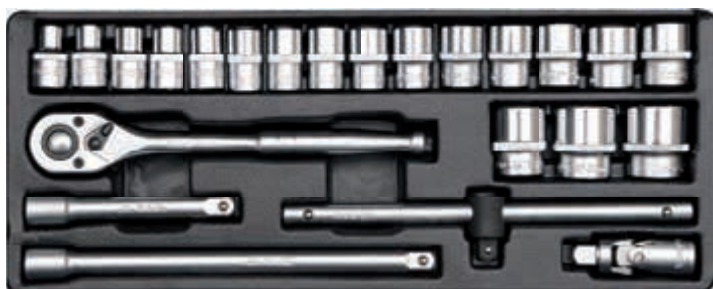

23
PCS

1/2" (12.7 mm): 10, 11, 12, 13, 14, 15, 16, 17, 18, 19, 20, 21, 22, 23, 24 mm (L=38 mm); 27, 30, 32 mm (L=42 mm); CrV 50BV30;
 1/2" (12.7 mm): (125, 250 mm); CrV 50BV30;
 1/2" (12.7 mm); CrV 50BV30;
 1/2" (12.7 mm); (250 mm); CrV 50BV30;
 1/2" (12.7 mm); (250 mm); 72T; CrV 6140

YATO		
YT-12651	1/2" (12.7 mm)	5



25
PCS

1/2" (12.7 mm): 10, 11, 12, 13, 14, 15, 16, 17, 18, 19, 20, 21, 22, 23, 24 mm (L=38 mm); 27, 30, 32 mm (L=42 mm); CrV 50BV30;
 1/2" (12.7 mm): (50, 125 mm); CrV 50BV30;
 1/2" (12.7 mm): 16, 21 mm; CrV 50BV30;
 1/2" (12.7 mm): (250 mm); CrV 50BV30;
 1/2" (12.7 mm): (250 mm); 72T; CrV 6140;
 1/2" (12.7 mm): (317 mm); CrV 50BV30

YATO		
YT-12671	1/2" (12.7 mm)	5

GB Tool set
D Sechskant-Steckschlüssel-Satz
PL Zestaw narzędziowy
RUS Набор инструмента

CZ Sada nástrčných klíčů a ráčny
H Dugókulcs készlet racsnis hajtókarral
RO Rotrusa chei tubulare cu antrenor
F Coffret d'outillage

I Set di utensili
E Juego de herramientas
CN 套筒扳手组套

BMC & COLOR SLEEVE
 L SIZE



1/2"
12.5mm
CrV
50BV30
CrV
6150
CrV
6140
S2
72T
AS-DRIVE



94
PCS

12pt

1/2" (12.7 mm): 10, 11, 12, 13, 14, 15, 16, 17, 18, 19, 20, 21, 22, 23, 24 mm (L=38 mm); 27, 30, 32 mm (L=42 mm); 1/4" (6.3 mm): 4, 4.5, 5, 5.5, 6, 7, 8, 9, 10, 11, 12, 13, 14 mm (L=25 mm); CrV 50BV30; 1/2" (12.7 mm): 14, 15, 17, 19 mm (L=76 mm); 1/4" (6.3 mm): 6, 7, 8, 9, 10, 11, 12, 13 mm (L=50 mm); CrV 50BV30; 1/2" (12.7 mm): 16, 21 mm; CrV 50BV30; 1/4" (6.3 mm): (50.8, 101.6 mm); CrV 50BV30; 3/8" (9.5 mm) (F) x 1/2" (12.7 mm) (M); CrV 50BV30; 1/4" (6.3 mm): (150 mm); CrV 6140; 1/2" (12.7 mm); 1/4" (6.3 mm); CrV 50BV30; 1/2" (12.7 mm): 16, 21 mm; CrV 50BV30; 1/4" (6.3 mm); (152.4 mm); CrV 50BV30; 1/2" (12.7 mm); (255 mm); 1/4" (6.3 mm); (155 mm); 72T; CrV 6140; 1/4" (6.3 mm); (150 mm); CrV 50BV30; 1/2" (12.7 mm) x 5/16" (7.9 mm); CrV 6140; 1/4" (6.3 mm) x 1/4" (6.3 mm) (L=25 mm); CrV 6140; 5/16" (7.9 mm): 8, 10, 12 mm (L=30 mm); AISI S2; 5/16" (7.9 mm): PH3, PH4 (L=30 mm); AISI S2; 5/16" (7.9 mm): PZ3, PZ4 (L=30 mm); AISI S2; 5/16" (7.9 mm): T40, T45, T50, T55 (L=30 mm); AISI S2; 5/16" (7.9 mm): 8, 10, 12, 14 mm (L=30 mm); AISI S2; 1/4" (6.3 mm): 4, 5.5, 7 mm (L=37 mm); AISI S2 / CrV 6150; 1/4" (6.3 mm): PZ1, PZ2 (L=37 mm); AISI S2 / CrV 6150; 1/4" (6.3 mm): T8, T10, T15, T20, T25, T30 (L=37 mm); AISI S2 / CrV 6150; 1/4" (6.3 mm): 3, 4, 5, 6 mm (L=37 mm); AISI S2 / CrV 6150; 1.5, 2.0, 2.5 mm; CrV 6150

YATO		
YT-12682	1/2" (12.7 mm)	1/4" (6.3 mm)
		4

- GB Tool set
- D Sechskant-Steckschlüssel-Satz
- PL Zestaw narzędziowy
- RUS Набор инструмента
- CZ Sada nástrčných klíčů a ráčny
- H Dugókulcs készlet
racsnis hajtókarral
- RO Rotrușa chei tubulare
cu antrenor
- F Coffret d'outillage
- I Set di utensili
- E Juego de herramientas
- CN 套筒扳手套装

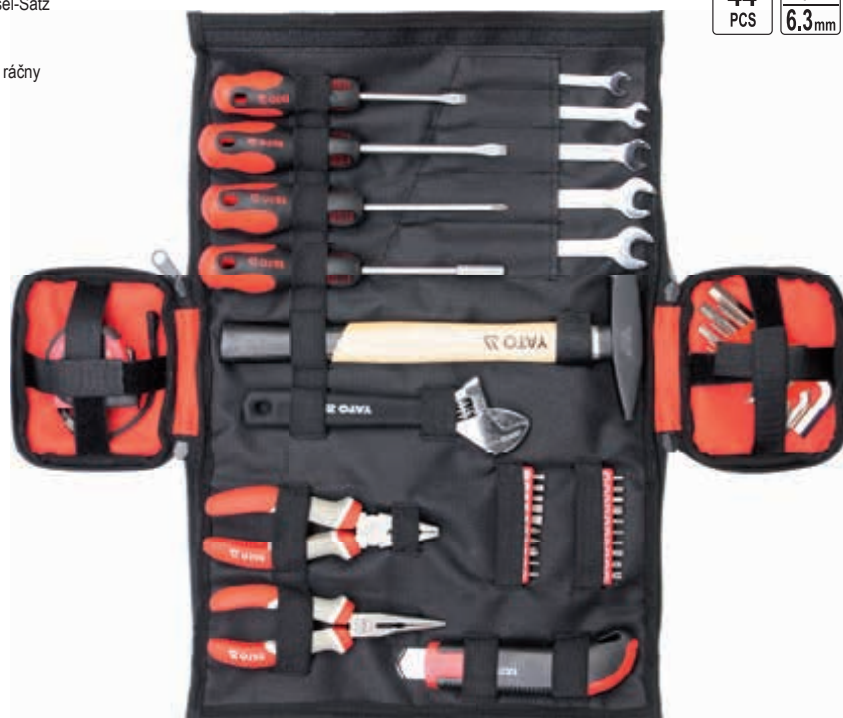

44 PCS	1/4" 6.3mm	⊖	⊕	⊕	⊕	⊕
		CrV	S2	SK2		



- ⊖ 6x7, 8x9, 10x11, 12x13, 14x15 mm;
- ⊕ 1/4" (6.3 mm): 3, 4, 5, 5.5, 6 mm (L=25 mm); AISI S2;
- ⊕ 1/4" (6.3 mm): PH1, PH2, PH3 (L=25 mm); AISI S2;
- ⊕ 1/4" (6.3 mm): T8, T10, T15, T20, T25, T27 (L=25 mm); AISI S2;
- ⊕ 1/4" (6.3 mm): 2, 2.5, 3, 4, 5, 6 mm (L=25 mm); AISI S2;
- 160 mm; 160 mm; 200 mm; 300 g (L=300 mm);
- 3 m x 16 mm; 18 mm; SK2; 1/4" (6.3 mm); CrV;
- 5x75, 6x100, PH2x100 mm; S2; 1.5, 2, 2.5, 3, 4, 5, 6, 8, 10 mm; CrV 6150



NYLON BAG & COLOR BOX

YATO		
YT-39280	1/4" (6.3 mm)	4

- GB Tool set for electricians
- D Werkzeug-Set für Elektriker
- PL Zestaw narzędziowy dla elektryków
- RUS Набор инструментов для электриков
- CZ Sada nářadí pro elektrikáře
- H Szerszámkészlet villanyszerelők
- RO Set de instrumente pt. electricieni
- F Un ensemble d'outils pour les électriciens
- I Set per l'elettricista
- E Um conjunto de ferramentas para electricistas
- CN 件电子绝缘工具组套



68 PCS	1/4" 6.3mm	CrV 50BV30	CrV 6150
		S2	1000 V
		D+E	



- ⊕ 1/4" (6.3 mm): 4, 4.5, 5, 5.5, 6, 7, 8, 9, 10, 11, 12, 13 mm (L=25 mm); CrV 50BV30;
- 140 mm; 190 mm; 3CRB; 150 mm;
- 160 mm; 1000 V; CrV; 160 mm; 1000 V; CrV;
- 3 m x 16 mm; 175 mm; 19.5 x 190 mm;
- 1.5 V; 9 LED; 9 mm; 19 mm x 20 mm;
- 1/4" (6.3 mm): (150 mm); CrV 50BV30;
- 1/4" (6.3 mm) x 1/4" (6.3 mm); CrV 6140; 10 g;
- 1.4, 2, 2.4 mm; PH00, PH0, PH1; S2;
- 4x75, 5.5x125, PH1x80, PH2x100 mm; 1000V; S2;
- ⊕ 1/4" (6.3 mm): 3, 4, 5, 5.5, 6 mm (L=25 mm); AISI S2;
- ⊕ 1/4" (6.3 mm): PH1, PH2, PH3 (L=25 mm); AISI S2;
- ⊕ 1/4" (6.3 mm): T8, T10, T15, T20, T25, T27 (L=25 mm); AISI S2;
- ⊕ 1/4" (6.3 mm): 2, 2.5, 3, 4, 5, 6 (L=25 mm); AISI S2;
- 1.5, 2, 2.5, 3, 4, 5, 6, 7, 8, 10 mm; CrV 6150

U 0-500 ~V	U 0-500 ~V	I 0-5 ~A	R 0-2 MΩ	⚡
		h _{FE} PNP NPN	5V P-P	📶
		12-250 ~V	50-500 Hz	LCD DISPLAY
		30W	230V~ 50Hz	NO BATTERY NEEDED NE POTREBUE BATERII
		400°C		TIP ∅ 3.8x70 mm

YATO		
YT-39009	1/4" (6.3 mm)	2

- GB Torx socket
- D Torx-Steckschlüssel
- PL Nasadka Torx
- RUS Головка
- CZ Nástavec Torx
- H Hatszögű rátét Torx
- RO Cheie tubulară Torx
- F Douille Torx
- I Bullone Torx
- E Boquilla Torx
- CN 星型套筒

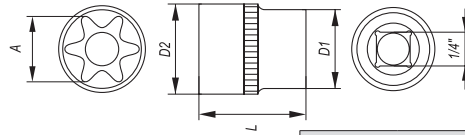

COLOR BOX



1/4"
6.3mm

TORX

CrV
50BV30

YATO	A (mm)	D1 (mm)	D2 (mm)	L (mm)	PCS packing	
YT-05211	E4	11.9	6.7	25	24	240/480
YT-05212	E5	11.9	7.2	25	24	240/480
YT-05213	E6	11.9	8.3	25	24	240/480
YT-05214	E7	11.9	9.4	25	24	240/480
YT-05215	E8	11.9	10.0	25	24	240/480

2

- GB Torx socket set
- D Torx-Steckschlüsselsatz
- PL Klucze nasadowe Torx
- RUS Набор головок
- CZ Nástrčné klíče
- H Dugókulcs
- RO Trusa tubulară
- F Clés à tube
- I Chiavi a bussola bulloni Torx
- E Llaves de vaso
- CN 星型套筒组套



9
PCS

TORX

CrV
50BV30

SLIDING CARD

- 1/4" (6.3 mm): E5, E6, E7, E8, 3/8" (9.5 mm): E10, E12, E14, E16;
- 1/4" (6.3 mm) (M) x 3/8" (9.5 mm) (F)

YATO		
YT-0520	1/4" (6.3 mm)	10/40

- GB Torx socket
- D Torx-Steckschlüssel
- PL Nasadka Torx
- RUS Головка
- CZ Nástavec Torx
- H Hatszögű rátét Torx
- RO Cheie tubulară Torx
- F Douille Torx
- I Bullone Torx
- E Boquilla Torx
- CN 星型套筒

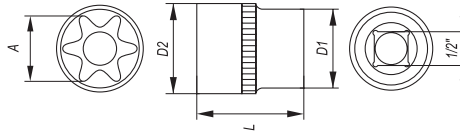

1/2"
12.5mm

TORX

CrV
50BV30

COLOR BOX



YATO	A (mm)	D1 (mm)	D2 (mm)	L (mm)	PCS packing	
YT-05220	E10	21.8	13.1	38	12	120/240
YT-05221	E11	21.8	13.9	38	12	120/240
YT-05222	E12	21.8	14.9	38	12	120/240
YT-05223	E14	21.8	16.3	38	12	120/240
YT-05224	E16	21.8	18.2	38	12	120/240

YATO	A (mm)	D1 (mm)	D2 (mm)	L (mm)	PCS packing	
YT-05225	E18	23.8	19.4	38	12	120/240
YT-05226	E20	21.8	23.9	38	12	120/240
YT-05227	E22	23.2	25.7	38	12	120/240
YT-05228	E24	23.8	27.8	38	12	60/120

- GB Torx socket set
- D Torx-Steckschlüsselsatz
- PL Klucze nasadowe Torx
- RUS Набор головок
- CZ Nástrčné klíče
- H Dugókulcs
- RO Trusa tubulară
- F Clés à tube
- I Chiavi a bussola bulloni Torx
- E Llaves de vaso
- CN 星型套筒组套



9
PCS

TORX

CrV
50BV30

METAL CASE & COLOR SLEEVE



- GB Go-through socket set
- D Durchgangs-Knarrenkasten
- PL Zestaw nasadek przelotowych z grzechotką
- RUS Набор торцевых головок сквозных с трещоткой
- CZ Sada průchodných nástrčných klíčů

- H Dugókulcs készlet, csavarzár átengedős
- RO Set chei tubulară cu crichet
- F Set de douilles à cliquet
- I Set chiavi a bussola con cricchetto

- E Juego de boquillas con orificio pasante, con carraca
- CN 套筒扳手组套

21
PCS

1/2"
12.5mm

1/4"
6.3mm

CrV
50BV30

CrV
6140

QUICK RELEASE SZYBKO-ZŁĄCZCE

METRIC METRYCZNE

IMPERIAL



- 10, 11, 12, 13, 14, 15, 16, 17, 18, 19 mm (L=32 mm);
- 3/8" (9.5 mm), 7/16" (11.1 mm), 1/2" (12.7 mm), 9/16" (14.3 mm),
- 5/8" (15.9 mm), 11/16" (17.5 mm), 3/4" (19.0 mm) (L=32 mm); CrV 50BV30;
- 178 mm; CrV 6140; 1/2" (12.7 mm), 1/4" (6.3 mm); CrV 6140;
- 17 mm (L=75 mm); CrV 50BV30

YATO			
YT-3865	1/2" (12.7 mm)	1/4" (6.3 mm)	3/12

BMC & COLOR SLEEVE



- GB** Hexagonal socket
D Sechskantenschlüssel
PL Nasadka sześciokątna
RUS Головка шестигранная
CZ Šestihranný nástavec
H Hatszögű rátét
RO Cheie tubulară hexagonală
F Douille 6 pans
I Chiave a bussola esagonale
E Boquilla hexagonal
CN 六角套筒

- application: industry, car service stations and workshops
- for high loads
- drive locks
- surface finish: chromed, satin
- przeznaczenie: przemysł, serwisy i warsztaty
- do największych obciążeń
- zamki blokujące
- wykończenie powierzchni: chromowana, satynowa

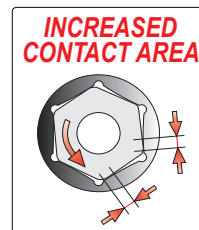
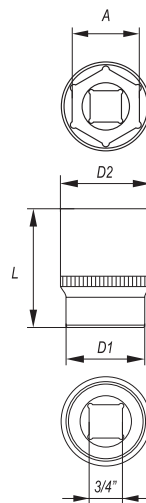

3/4"
19mm **DIN 3121**

CrV 50BV30 **AS-DRIVE**

COLOR BOX



YATO	∅ A (mm)	D1 (mm)	D2 (mm)	L (mm)	PCS packing:	
YT-1301	19	30	36	50	12	96
YT-1302	21	32	36	50	12	96
YT-1303	22	32	36	50	12	96
YT-1304	23	34	36	50	12	96
YT-1305	24	34	36	50	12	96
YT-1306	25	36	36	50	12	96
YT-1307	26	37	34	50	12	96
YT-1308	27	38	34	50	12	96
YT-1309	28	40	34	50	12	96
YT-1310	29	40	35	50	12	96
YT-1311	30	42	36	55	8	48
YT-1312	32	44	37	55	8	48
YT-1313	33	46	38	55	8	48

YATO	∅ A (mm)	D1 (mm)	D2 (mm)	L (mm)	PCS packing:	
YT-1314	34	47	38	55	8	48
YT-1315	35	48	42	60	6	36
YT-1316	36	50	42	60	6	36
YT-1317	38	52	45	60	6	36
YT-1318	41	56	45	65	4	32
YT-1319	42	57	45	65	4	32
YT-1320	43	58	45	65	4	32
YT-1322	46	62	48	70	4	32
YT-1323	48	64	48	70	4	24
YT-1324	50	68	48	70	4	24
YT-1326	52	70	48	70	4	20
YT-1328	55	73	48	75	4	20
YT-1330	60	80	48	80	4	20

- GB** Extension bar
D Verlängerung
PL Przedłużka
RUS Удлинитель для воротка
CZ Prodlužovací příravek
H Toldalék
RO Prelungitor
F Rallonge
I Prolunga
E Tubo de prolongación
CN 接杆

3/4"
19mm **DIN 3121** **CrV 50BV30**

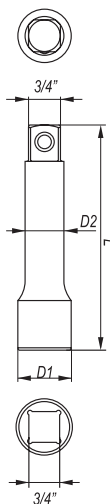

COLOR BOX

YATO	∅	D1 (mm)	D2 (mm)	L (mm)	PCS packing:	
YT-1340	3/4" (19.0 mm)	36	22	100	6	36
YT-1341	3/4" (19.0 mm)	36	22	200	5	20
YT-1342	3/4" (19.0 mm)	36	22	400	5	10

- GB** Sliding T-bar
D Handgriff mit Gleitstück
PL Pokrętko typu „T”
RUS Вороток Т-образный
CZ Otočná račká typ „T”
H „T” alakú hajtókar
RO Mâner clupă tipul „T”
E Mango tipo „T”
F Barre type „T”
I Manopola „T” scorrevole
CN 滑行杆

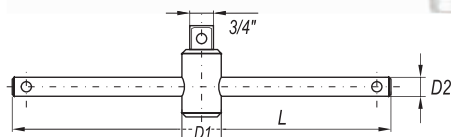
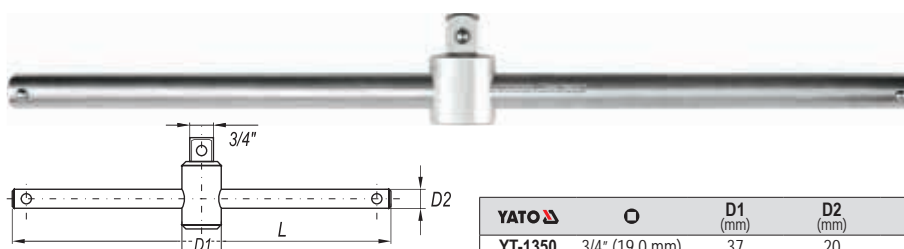

- GB** Adapter
D Reduktion
PL Redukcja
RUS Переходник
CZ Redukce
H Redukció
RO Reducție
F Réduction
I Riduttore
E Reducción
CN 转换头

3/4"
19mm **DIN 3121** **CrV 50BV30**

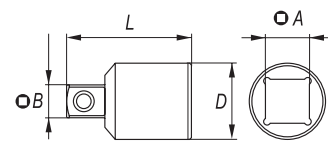

COLOR BOX



YATO	∅ A	∅ B	D (mm)	L (mm)	PCS packing:	
YT-1355	3/4" (19.0 mm)	(F) 1/2" (12.7 mm) (M)	36	53	12	48

- GB** Universal joint
D Kardangelenk
PL Przegub Cardana
RUS Карданный шарнир
CZ Kardanový kloub
H Kardán csukló
RO Articulație Cardanică
F Cardan
I Snodo cardanico
E Articulación Cardan
CN 万向接头

3/4"
19mm **DIN 3121** **CrV 50BV30**

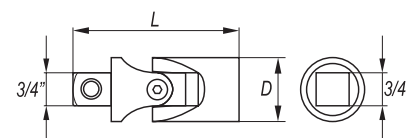

COLOR BOX



YATO	∅	D (mm)	L (mm)	PCS packing:	
YT-1352	3/4" (19.0 mm)	40	106	12	36

YATO	∅	D1 (mm)	D2 (mm)	L (mm)	PCS packing:	
YT-1350	3/4" (19.0 mm)	37	20	500	5	10

- GB Flexible handle
- D Gelenkgriff
- PL Pokręto lamane
- RUS Вороток шарнирный
- CZ Otočná lomená rávka
- H Hajlított hajtókar
- RO Prelungitor cu prindere flexibilă
- F Barre pivotante
- I Manopola a snodo
- E Mango articulado
- CN 转向手柄

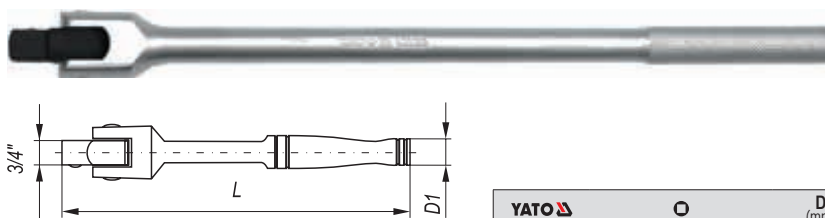

3/4" 19mm
DIN 3121
CrV 50BV30



YATO	Ø	D (mm)	L (mm)	PCS packing	
YT-1345	3/4" (19.0 mm)	25	507	5	10

- GB L-type handle
- D Admutternschlüssel
- PL Pokręto typu „L”
- RUS Вороток тип „L”
- CZ Páka zahnutá „L” alakú hajtókar
- H „L” alakú hajtókar
- RO Mâner clupă tipul „L”
- F Barre type „L”
- I Leva tipo „L”
- E Mango tipo „L”
- CN L型套筒扳手

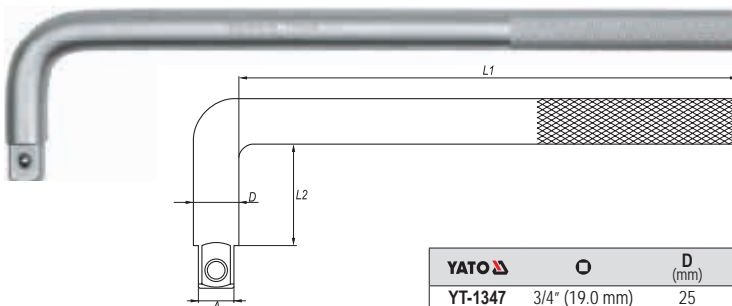

3/4" 19mm
DIN 3121
CrV 50BV30



YATO	Ø	D (mm)	L1 (mm)	L2 (mm)	PCS packing	
YT-1347	3/4" (19.0 mm)	25	560	75	5	10
YT-1348	3/4" (19.0 mm)	25	415	75	5	10

- GB L-type handle
- D Admutternschlüssel
- PL Pokręto typu „L”
- RUS Вороток тип „L”
- CZ Páka zahnutá „L” alakú hajtókar
- H „L” alakú hajtókar
- RO Mâner clupă tipul „L”
- F Barre type „L”
- I Leva tipo „L”
- E Mango tipo „L”
- CN L型套筒扳手

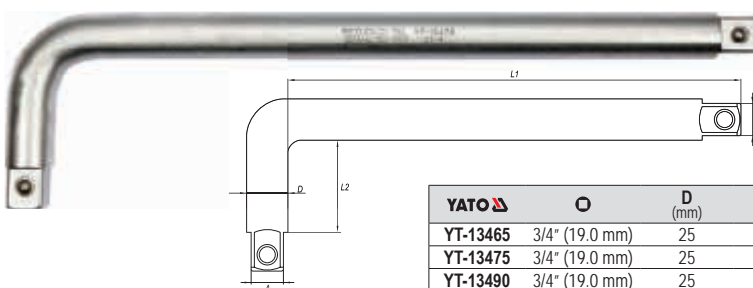

3/4" 19mm
DIN 3122
CrV 50BV30



YATO	Ø	D (mm)	L1 (mm)	L2 (mm)	PCS packing	
YT-13465	3/4" (19.0 mm)	25	275	75	2	12
YT-13475	3/4" (19.0 mm)	25	373	75	2	8
YT-13490	3/4" (19.0 mm)	25	578	75	2	8

- GB Quick release ratchet handle
- D Hebelumschaltknarre
- PL Grzechotka
- RUS Трещотка
- CZ Rehtačka
- H Racsnis hajtókar
- RO Dispozitiv de prindere cu clichet
- F Clé à cliquet
- I Cricchetto bussola
- E Carraca
- CN 快速脱落棘轮扳手

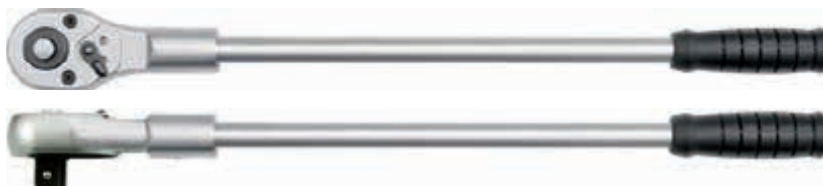

3/4" 19mm
DIN 3122
24T
QUICK RELEASE SZYBKO-ZŁĄCZE
CrV 6140



YATO	Ø	T	L (mm)	
YT-1360	3/4" (19.0 mm)	24	625	10

- GB Socket set
- D Sechskant-Steckschlüssel-Satz
- PL Komplet nasadek z akcesoriami
- RUS Набор насадок
- CZ Sada nástrčných klíčů a ráčny
- H Dugókulcs készlet racsnis hajtókarral
- RO Rotrușa chei tubulare cu antrenor
- F Clé à cliquet
- I Cricchetto bussola
- E Juego de boquillas con accesorios
- CN 套筒扳手套组



METAL CASE & COLOR BOX

3/4" 19mm
CrV 50BV30
CrV 6140

QUICK RELEASE SZYBKO-ZŁĄCZE
24T



15 PCS

AS-DRIVE

3/4" (19.0 mm): 30, 32, 34 (L=55 mm); 36, 38 (L=60 mm); 41 (L=65 mm); 46, 50 (L=70 mm); 55 (L=75 mm); 60 mm (L=80 mm); CrV 50BV30; 3/4" (19.0 mm): (L=500 mm); 24T; CrV 6140; 3/4" (19.0 mm): (L=500 mm); CrV 50BV30; 3/4" (19.0 mm): (L=100, 200 mm); CrV 50BV30; 3/4" (19.0 mm): (L=106 mm); CrV 50BV30

YATO	Ø	
YT-1334	3/4" (19.0 mm)	1

20 PCS

3/4" (19.0 mm): 19, 21, 22, 24 mm (L=50 mm); 26, 27, 28 mm (L=52 mm); 30, 32 mm (L=53 mm); 33, 34 mm (L=56 mm); 36 mm (L=58 mm); 38 mm (L=60 mm); 41 mm (L=64 mm); 46 mm (L=68 mm); 50 mm (L=72 mm); CrV 50BV30; 3/4" (19.0 mm) x 620 mm; CrV 6140; 3/4" (19.0 mm): (L=500 mm); CrV 50BV30; 3/4" (19.0 mm) x 100 mm, 3/4" (19.0 mm) x 200 mm; CrV 50BV30

YATO	Ø	
YT-1335	3/4" (19.0 mm)	1

- GB** Star bit sockets
D Aufsteckschlüssel
PL Klucze trzpieniowe
RUS Набор головок-вставок
CZ Čepové klíče
H Csapkulcs
- RO** Chei cu cozi
F Douille tournevis
I Chiavi a bussola
E Llaves de mandril
CN 星型旋具套筒



PLASTIC HANGER



1/4"	AISI S2
6.3mm	
CrV 6150	HRC 58-62
DIN 3120	

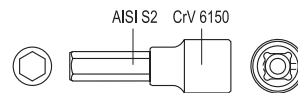
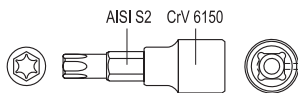

YATO	Ø	Star	L (mm)	torque / moment obrotowy max. (Nm)	Box
YT-04301	1/4" (6.3 mm)	T8	37	2.6	150/600
YT-04302	1/4" (6.3 mm)	T10	37	4.6	150/600
YT-04303	1/4" (6.3 mm)	T15	37	7.7	150/600
YT-04304	1/4" (6.3 mm)	T20	37	12.7	150/600
YT-04305	1/4" (6.3 mm)	T25	37	19.0	150/600
YT-04306	1/4" (6.3 mm)	T30	37	37.4	150/600
YT-04307	1/4" (6.3 mm)	T40	37	65.0	150/600

YATO	Ø	Hex	L (mm)	torque / moment obrotowy max. (Nm)	Box
YT-04370	1/4" (6.3 mm)	3	37	6.6	150/600
YT-04371	1/4" (6.3 mm)	4	37	16.0	150/600
YT-04372	1/4" (6.3 mm)	5	37	30.0	150/600
YT-04373	1/4" (6.3 mm)	6	37	52.2	150/600
YT-04374	1/4" (6.3 mm)	7	37	78.0	150/600
YT-04375	1/4" (6.3 mm)	8	37	120.0	150/600

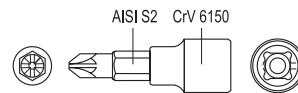
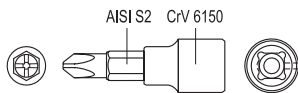

YATO	Ø	+	L (mm)	torque / moment obrotowy max. (Nm)	Box
YT-04411	1/4" (6.3 mm)	PH1	37	3.5	150/600
YT-04412	1/4" (6.3 mm)	PH2	37	8.2	150/600
YT-04413	1/4" (6.3 mm)	PH3	37	19.5	150/600

YATO	Ø	+	L (mm)	torque / moment obrotowy max. (Nm)	Box
YT-04417	1/4" (6.3 mm)	PZ1	37	3.5	150/600
YT-04418	1/4" (6.3 mm)	PZ2	37	8.2	150/600

- GB** Insulated star bit socket
D Aufsteckschlüssel vollisoliert
PL Klucze trzpieniowe izolowane
RUS Головка торцевая с вставкой hex изолированная
CZ Čepové klíče izolované
H Csapkulcs
RO Chei cu cozi izolat
F Douille tournevis isolée
I Chiave esagonale isolato
E Llaves de mandril aislante
CN 绝缘套筒批

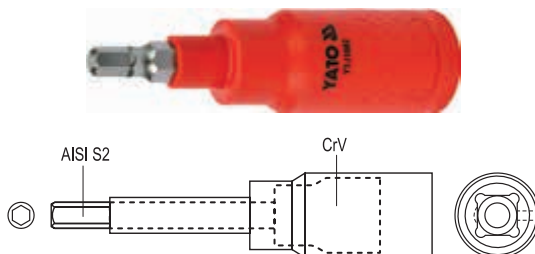

POLYBAG



3/8"	CrV
10mm	
1000 V	D'E

1000V
VDE CERTIFICATE
EN 60900:2012

YATO	Ø	Hex	L (mm)	torque / moment obrotowy max. (Nm)	Box
YT-21080	3/8" (9.5 mm)	4	75	16.0	12/144
YT-21081	3/8" (9.5 mm)	5	75	30.0	12/144
YT-21082	3/8" (9.5 mm)	6	75	52.0	12/144
YT-21083	3/8" (9.5 mm)	8	75	120.0	12/144

- GB** Star bit sockets
D Aufsteckschlüssel
PL Klucze trzpieniowe
RUS Набор головок-вставок
CZ Čepové klíče
H Csapkulcs
- RO** Chei cu cozi
F Douille tournevis
I Chiavi a bussola
E Llaves de mandril
CN 星型旋具套筒



PLASTIC HANGER



1/2"	AISI S2
12.5mm	
CrV 6150	HRC 58-62
DIN 3120	

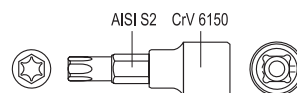
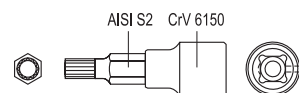
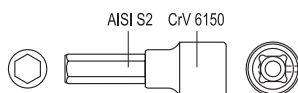

YATO	Ø	Hex	L (mm)	torque / moment obrotowy max. (Nm)	Box
YT-04381	1/2" (12.7 mm)	5	55	30.0	40/240
YT-04382	1/2" (12.7 mm)	6	55	52.0	40/240
YT-04383	1/2" (12.7 mm)	7	55	78.0	40/240
YT-04384	1/2" (12.7 mm)	8	55	120.0	40/240
YT-04385	1/2" (12.7 mm)	10	55	220.0	40/160
YT-04386	1/2" (12.7 mm)	12	55	370.0	40/160
YT-04387	1/2" (12.7 mm)	14	55	590.0	40/160
YT-04388	1/2" (12.7 mm)	17	55	1000.0	40/160

YATO	Ø	Hex	L (mm)	torque / moment obrotowy max. (Nm)	Box
YT-04341	1/2" (12.7 mm)	M6	55	30.0	40/240
YT-04342	1/2" (12.7 mm)	M8	55	52.0	40/240
YT-04343	1/2" (12.7 mm)	M10	55	120.0	40/160
YT-04344	1/2" (12.7 mm)	M12	55	220.0	40/160
YT-04345	1/2" (12.7 mm)	M14	55	370.0	40/160
YT-04346	1/2" (12.7 mm)	M16	55	590.0	40/160

YATO	Ø	Star	L (mm)	torque / moment obrotowy max. (Nm)	Box
YT-04310	1/2" (12.7 mm)	T20	55	12.7	40/240
YT-04311	1/2" (12.7 mm)	T25	55	19.0	40/240
YT-04312	1/2" (12.7 mm)	T27	55	27.0	40/240
YT-04313	1/2" (12.7 mm)	T30	55	37.4	40/240
YT-04314	1/2" (12.7 mm)	T40	55	65.0	40/240
YT-04315	1/2" (12.7 mm)	T45	55	103.5	40/240
YT-04316	1/2" (12.7 mm)	T50	55	159.0	40/240
YT-04317	1/2" (12.7 mm)	T55	55	257.0	40/240
YT-04318	1/2" (12.7 mm)	T60	55	445.0	40/240
YT-04319	1/2" (12.7 mm)	T70	55	700.0	40/160

- GB** Star bit sockets
D Aufsteckschlüssel
PL Klucze trzpieniowe
RUS Набор головок-вставок
CZ Čepové klíče
H Csapkulcs
- RO** Chei cu cozi
F Douille tournevis
I Chiavi a bussola
E Llaves de mandril
CN 星型旋具套筒

AISI S2
CrV 6150

PLASTIC HANGER

1/2"
12.5mm

AISI S2

CrV 6150

HRC 58-62

DIN 3120

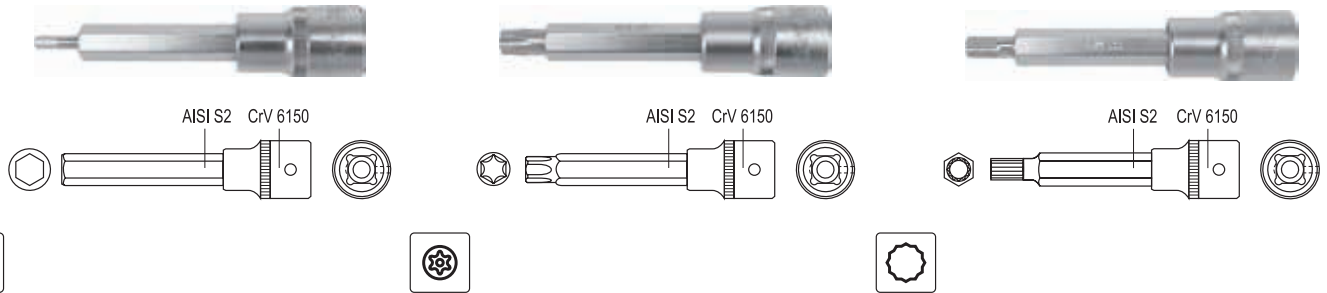



YATO	Ø	⊘	L (mm)	torque / moment obrotowy max. (Nm)	⊠
YT-04390	1/2" (12.7 mm)	4	100	16.0	20/120
YT-04391	1/2" (12.7 mm)	5	100	30.0	20/120
YT-04392	1/2" (12.7 mm)	6	100	52.0	20/120
YT-04393	1/2" (12.7 mm)	7	100	78.0	20/120
YT-04394	1/2" (12.7 mm)	8	100	120.0	20/120
YT-04395	1/2" (12.7 mm)	10	100	220.0	20/120
YT-04396	1/2" (12.7 mm)	12	100	370.0	20/120
YT-04397	1/2" (12.7 mm)	14	100	590.0	20/120
YT-04398	1/2" (12.7 mm)	17	100	1000.0	20/120

YATO	Ø	⊘	L (mm)	torque / moment obrotowy max. (Nm)	⊠
YT-04320	1/2" (12.7 mm)	T20	100	12.7	20/120
YT-04321	1/2" (12.7 mm)	T25	100	19.0	20/120
YT-04322	1/2" (12.7 mm)	T27	100	27.0	20/120
YT-04323	1/2" (12.7 mm)	T30	100	37.4	20/120
YT-04324	1/2" (12.7 mm)	T40	100	65.0	20/120
YT-04325	1/2" (12.7 mm)	T45	100	103.5	20/120
YT-04326	1/2" (12.7 mm)	T50	100	159.0	20/120
YT-04327	1/2" (12.7 mm)	T55	100	257.0	20/120
YT-04328	1/2" (12.7 mm)	T60	100	445.0	20/120
YT-04329	1/2" (12.7 mm)	T70	100	700.0	20/120

YATO	Ø	⊘	L (mm)	torque / moment obrotowy max. (Nm)	⊠
YT-04350	1/2" (12.7 mm)	M5	100	16.0	20/120
YT-04351	1/2" (12.7 mm)	M6	100	30.0	20/120
YT-04352	1/2" (12.7 mm)	M8	100	52.0	20/120
YT-04353	1/2" (12.7 mm)	M10	100	120.0	20/120
YT-04354	1/2" (12.7 mm)	M12	100	220.0	20/120
YT-04355	1/2" (12.7 mm)	M14	100	370.0	20/120
YT-04356	1/2" (12.7 mm)	M16	100	590.0	20/120
YT-04357	1/2" (12.7 mm)	M17	100	590.0	20/120

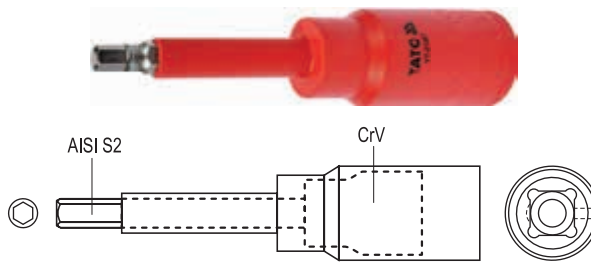
- GB** Insulated star bit socket
D Aufsteckschlüssel vollisoliert
PL Klucze trzpieniowe izolowane
RUS Головка торцевая с вставкой hex изолированная
CZ Čepové klíče izolované
H Csapkulcs
RO Chei cu cozi izolat
F Douille tournevis isolée
I Chiave esagonale isolato
E Llaves de mandril aislante
CN 绝缘套筒批



POLYBAG

1/2"
12.5mm

CrV

1000 V

1000V
VDE CERTIFICATE
EN 60900:2012



YATO	Ø	⊘	L (mm)	torque / moment obrotowy max. (Nm)	⊠
YT-21085	1/2" (12.7 mm)	4	120	16.0	18/144
YT-21086	1/2" (12.7 mm)	5	120	30.0	18/144
YT-21087	1/2" (12.7 mm)	6	120	52.0	18/144
YT-21088	1/2" (12.7 mm)	8	120	120.0	18/144
YT-21089	1/2" (12.7 mm)	10	120	220.0	18/144

- GB** Star bit sockets
D Aufsteckschlüssel
PL Klucze trzpieniowe
RUS Набор головок-вставок
CZ Čepové klíče
H Csapkulcs
- RO** Chei cu cozi
F Douille tournevis
I Chiavi a bussola
E Llaves de mandril
CN 星型旋具套筒

AISI S2
CrV 6150

SLIDING CARD

1/4"
6.3mm

3/8"
10mm

AISI S2

CrV 6150

HRC 58-62

DIN 3120



12 PCS

TORX

1/4" (6.3 mm): L=37 mm; T8, T10, T15, T20, T25, T27, T30
 3/8" (9.5 mm): L=48 mm; T40, T45, T47, T50, T55

12 PCS

TORX TAMPERPROOF

1/4" (6.3 mm): L=37 mm; T8, T10, T15, T20, T25, T27, T30
 3/8" (9.5 mm): L=48 mm; T40, T45, T47, T50, T55

YATO	⊠
YT-04331	10/40

YATO	⊠
YT-04332	10/40



9 PCS

HEX

1/4" (6.3 mm): L=37 mm; 2, 3, 4, 5, 6 mm
 3/8" (9.5 mm): L=48 mm; 7, 8, 10, 12 mm

5 PCS

SPLINE

1/4" (6.3 mm): L=37 mm; M5, M6
 3/8" (9.5 mm): L=48 mm; M8, M10, M12

YATO	⊠
YT-04401	6/36

YATO	⊠
YT-04360	12/48

- GB** Star bit sockets
D Aufsteckschlüssel
PL Klucze trzpieniowe
RUS Набор головок-вставок
CZ Čepové klíče
H Csapkulcs
RO Chei cu cozi
F Douille tournevis
I Chiavi a bussola
E Llaves de mandril
CN 星型旋具套筒



SLIDING CARD
AISI S2
CrV 6150



7
PCS

1/4"
6.3mm

DIN
3120

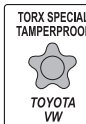

21.8
max.

AISI
S2

HRC
58-62

1/4" (6.3 mm): TS10; TS15; TS20; TS25; TS27; TS30; TS40 (L=35 mm)

YATO	
YT-0461	12/48

- GB** Bit socket set
D Aufsteckschlüssel-Satz
PL Zestaw kluczy trzpieniowych
RUS Набор головок-вставок

- CZ** Čepové klíče
H Csapkulcs
RO Chei cu cozi
F Set de douilles tournevis

- I** Chiavi a bussola a vite
E Juego de llaves de mandril
CN 套筒批头组套

BMC
& COLOR
SLEEVE



18
PCS

1/2"
12.5mm

1/4"
6.3mm

CrV
6150

HRC
58-62

AISI
S2

DIN
3120



1/2" (12.7 mm): T30, T40, T45, T50, T55, T60 (L=50 mm);
T30, T40, T45, T50, T55, T60 (L=100 mm); AISI S2 / CrV 6150;
1/4" (6.3 mm): T10, T15, T20, T25, T30, T40 (L=37 mm); AISI S2 / CrV 6150

YATO			
YT-7751	1/2" (12.7 mm)	1/4" (6.3 mm)	10



1/2" (12.7 mm): 5, 6, 7, 8, 10, 12 mm (L=50 mm);
5, 6, 7, 8, 10, 12 mm (L=100 mm); AISI S2 / CrV 6150;
1/4" (6.3 mm): 3, 4, 5, 6, 7, 8 mm (L=37 mm); AISI S2 / CrV 6150

YATO			
YT-7752	1/2" (12.7 mm)	1/4" (6.3 mm)	10

- GB** Bit socket set
D Aufsteckschlüssel-Satz
PL Zestaw kluczy trzpieniowych
RUS Набор головок-вставок

- CZ** Čepové klíče
H Csapkulcs
RO Chei cu cozi
F Set de douilles tournevis

- I** Chiavi a bussola a vite
E Juego de llaves de mandril
CN 套筒批头组套

BMC
& COLOR
SLEEVE



12
PCS

1/2"
12.5mm

CrV
6150

HRC
58-62

AISI
S2

DIN
3120



1/2" (12.7 mm): M12, M17 (L=50 mm); M6 (L=70 mm); M7, M8 (L=100 mm);
M8, M10 (L=120 mm); M6, M10, M12 (L=140 mm); M5 (L=180 mm);
M6 (L=250 mm); AISI S2 / CrV 6150

YATO			
YT-7753	1/2" (12.7 mm)		10

3

**Impact sockets,
accessories & sets**
**Udarowe klucze nasadowe,
akcesoria i zestawy**



Impact sockets 3/8"
Klucze nasadowe udarowe 3/8"

60



Impact sockets 1"
Udarowe klucze nasadowe 1"

63



Impact sockets sets

Zestawy kluczy nasadowych udarowych krótkich..... 60

Impact sockets

Klucze nasadowe udarowe, krótkie..... 63

Deep impact sockets

Klucze nasadowe udarowe, długie..... 63

Impact sockets 1/2"
Klucze nasadowe udarowe 1/2"

60-61



Impact accessories 1"
Akcesoria udarowe 1"

63



Impact sockets & sets

Klucze nasadowe udarowe i zestawy, krótkie..... 60

Deep impact sockets & sets

Klucze nasadowe udarowe i zestawy, długie..... 60

Impact extension bars with adapter

Przedłużki udarowe z redukcją..... 63

Impact accessories 1/2"
Akcesoria udarowe 1/2"

61



Impact sockets for front hub nuts
Nasadki udarowe do piast

63-64



Impact extension bars

Przedłużki udarowe..... 61

Impact adapters

Redukcje udarowe..... 61

Impact universal joints

Przeguby kuliste udarowe..... 61

Impact bit socket sets 1/2"

Zestawy udarowych kluczy trzpieniowych 1/2"

64



Impact sockets 3/4"
Udarowe klucze nasadowe 3/4"

61-62



Spline impact bit sets 3/4"

Zestawy bitów udarowych „Spline” 3/4"

64



Impact sockets & sets

Klucze nasadowe udarowe i zestawy, krótkie..... 61

Deep impact sockets & sets

Klucze nasadowe udarowe i zestawy, długie..... 62

Impact accessories 3/4"
Akcesoria udarowe 3/4"

62-63



Impact extension bars

Przedłużki udarowe..... 62

Impact adapters

Redukcje udarowe..... 62

Impact universal joints

Przeguby kuliste udarowe..... 62

- GB Impact socket set
- D Kraftschrauber-Einsätze
- PL Zestaw nasadek udarowych
- RUS Набор торцевых ударных головок
- CZ Sada nástrčných klíčů pro úderové utahováky
- H Dugófej készlet ütvebehajtóhoz
- RO Set chei tubulare pt. impact
- F Douille profonde à choc
- I Chiave a bussola esagonale per percussione
- E Juego de boquillas de percusión cortas
- CN 风动套筒组套

METAL CASE & COLOR BOX



10 PCS 3/8" 10mm CrMo SCM-440



3/8" (9.5 mm): 10, 12, 13, 14, 15, 16, 17, 18, 19, 22 mm (L=39 mm)

YATO	○	
YT-37690	3/8" (9.5 mm)	20

- GB Hexagonal impact socket
- D Kraftschrauber-Einsatz
- PL Nasadka udarowa sześciokątna
- RUS Головка ударная 6-гранная
- CZ Šestihranný nástavec
- H Hatszögű rátét
- RO Cheie tubulară hexagonală de impact
- F Douille à choc
- I Chiave a bussola esagonale per percussione
- E Boquilla de percusión
- CN 六角风动套筒

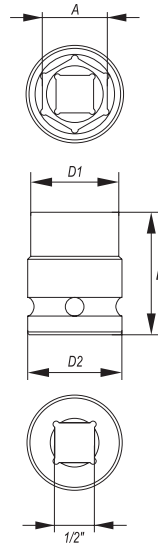

1/2" 12.5mm CrMo SCM-440 AS-DRIVE

YATO	○ A (mm)	D1 (mm)	D2 (mm)	L (mm)	PCS packing	
YT-1000	10	17.5	25.0	39	60	240
YT-1001	11	18.5	25.0	39	60	240
YT-1002	12	20.0	25.0	39	60	240
YT-1003	13	21.0	25.0	39	60	240
YT-1004	14	22.5	25.0	39	60	240
YT-1005	15	23.5	30.0	39	40	160
YT-1006	16	24.0	30.0	39	40	160
YT-1007	17	26.0	30.0	39	40	160
YT-1008	18	27.5	30.0	39	40	160
YT-1009	19	28.0	30.0	39	40	160
YT-1010	20	30.0	30.0	39	40	160
YT-1011	21	30.0	30.0	39	40	160
YT-1012	22	32.0	30.0	39	30	120
YT-1013	23	32.0	30.0	39	30	120
YT-1014	24	34.0	30.0	43	30	120
YT-1015	25	35.0	30.0	43	30	120
YT-1016	26	38.0	30.0	43	24	96
YT-1017	27	38.0	30.0	43	24	96
YT-1018	28	40.0	30.0	48	24	96
YT-1019	29	41.0	30.0	48	22	88
YT-1020	30	42.0	30.0	48	24	96
YT-1022	32	44.0	30.0	48	20	80

COLOR BOX



- GB Impact socket set
- D Kraftschrauber-Einsätze
- PL Zestaw nasadek udarowych
- RUS Набор торцевых ударных головок
- CZ Sada nástrčných klíčů pro úderové utahováky
- H Dugófej készlet ütvebehajtóhoz
- RO Set chei tubulare pt. impact
- F Douille profonde à choc
- I Chiave a bussola esagonale per percussione
- E Juego de boquillas de percusión cortas
- CN 风动套筒组套

METAL CASE & COLOR BOX



10 PCS 1/2" 12.5mm CrMo SCM-440 AS-DRIVE



1/2" (12.7 mm): 10, 12, 13, 14, 15, 16, 17, 18, 19, 22 mm (L=39 mm)

YATO	○	
YT-1025	1/2" (12.7 mm)	20

- GB Hexagonal deep impact socket
- D Kraftschrauber-Einsatz, lang
- PL Nasadka udarowa sześciokątna długa
- RUS Головка ударная 6-гранная глубокая
- CZ Šestihranný hluboký nástavec
- H Hatszögű rátét mély
- RO Cheie tubulară hexagonală de impact adâncă
- F Douille profonde à choc
- I Chiave a bussola esagonale per percussione
- E Boquilla de percusión profunda
- CN 六角风动长套筒

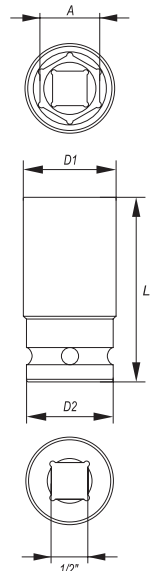

1/2" 12.5mm CrMo SCM-440 AS-DRIVE

YATO	○ A (mm)	D1 (mm)	D2 (mm)	L (mm)	PCS packing	
YT-1030	10	17.5	24.0	78	30	120
YT-1031	11	18.5	24.0	78	30	120
YT-1032	12	20.0	24.0	78	30	120
YT-1033	13	21.0	24.0	78	30	120
YT-1034	14	22.0	24.0	78	30	120
YT-1035	15	23.7	24.0	78	30	120
YT-1036	16	24.0	24.0	78	30	120
YT-1037	17	26.0	26.0	78	25	100
YT-1038	18	28.0	28.0	78	24	96
YT-1039	19	28.0	28.0	78	24	96
YT-1040	20	30.0	30.0	78	20	80
YT-1041	21	30.0	30.0	78	20	80
YT-1042	22	32.0	30.0	78	18	72
YT-1043	23	32.0	30.0	78	15	60
YT-1044	24	34.0	30.0	78	15	60
YT-1045	25	35.0	30.0	78	15	60
YT-1046	26	38.0	30.0	78	12	48
YT-1047	27	38.0	30.0	78	12	48
YT-1048	28	40.0	30.0	78	12	48
YT-1049	29	41.0	30.0	78	10	40
YT-1050	30	42.0	30.0	78	10	40
YT-1052	32	44.0	30.0	78	10	40

COLOR BOX



Impact sockets, accessories & sets Udarowe klucze nasadowe, akcesoria i zestawy



- GB** Impact socket set
D Kraftschrauber-Einsätze
PL Zestaw nasadek udarowych
RUS Набор торцевых ударных головок
CZ Sada nástrčných klíčů pro úderové utahováky

- H** Dugófej készlet ütvebehajtóhoz
RO Set chei tubulare pt. impact
F Set de douilles à choc
I Chiave a bussola esagonale per percussione

- E** Juego de boquillas de percusión cortas
CN 风动套筒组套



1/2"
12.5mm CrMo SCM-440 AS-DRIVE



11
PCS

1/2" (12.7 mm): 10, 12, 13, 14, 15, 16, 17, 18, 19, 22, 24 mm (L=39 mm)

15
PCS

1/2" (12.7 mm): 10, 12, 13, 14, 15, 16, 17, 18, 19, 21, 22, 24, 27, 30, 32 mm (L=39 mm)

YATO	Ø	PCS
YT-1054	1/2" (12.7 mm)	10

YATO	Ø	PCS
YT-1055	1/2" (12.7 mm)	4

- GB** Impact extension bar
D Verlängerung
PL Przedłużka udarowa
RUS Удлинитель ударный
CZ Prodlužovací příravek
H Toldalék
RO Prelungitor
F Rallonge
I Prolunga per percussione
E Tubo de prolongación
CN 风动接杆

1/2"
12.5mm CrMo SCM-440

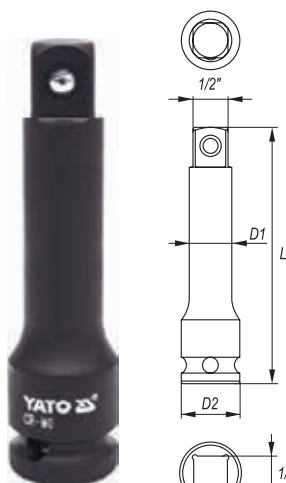

YATO	Ø	D1 (mm)	D2 (mm)	L (mm)	PCS packing	PCS
YT-1060	1/2" (12.7 mm)	17.5	25.0	75	40	160
YT-1061	1/2" (12.7 mm)	18.5	25.0	125	28	112
YT-1062	1/2" (12.7 mm)	20.0	25.0	250	30	60

- GB** Impact adapter
D Reduktion
PL Redukcja udarowa
RUS Переходник
CZ Redukce
H Redukció
RO Reducție
F Réduction
I Prolunga per percussione
E Reducción
CN 风动转换头

1/2"
12.5mm CrMo SCM-440



YATO	Ø	Ø	D (mm)	L (mm)	PCS packing	PCS
YT-1067	1/2" (12.7 mm) (F)	3/4" (19.0 mm) (M)	30	48	40	160

- GB** Impact universal joint
D Gelenkstück
PL Przegub kulisty udarowy
RUS Кардан ударный
CZ Kloub kulový
H Univerzális csuklós csatlakozó
RO Adaptor
F Flector rond
I Prolunga per percussione
E Articulación redonda
CN 风动方向接头

1/2"
12.5mm CrMo SCM-440



YATO	Ø	D1 (mm)	D2 (mm)	L (mm)	PCS packing	PCS
YT-1064	1/2" (12.7 mm)	31	17	63	25	100

- GB** Hexagonal impact socket
D Kraftschrauber-Einsatz
PL Nasadka udarowa sześciokątna
RUS Головка ударная 6-гранная
CZ Šestihranný nástavec
H Hatszögű rátét
RO Cheie tubulară hexagonală de impact
F Douille à choc
I Chiave a bussola esagonale per percussione
E Boquilla de percusión
CN 六角风动套筒

3/4"
19mm CrMo SCM-440 AS-DRIVE

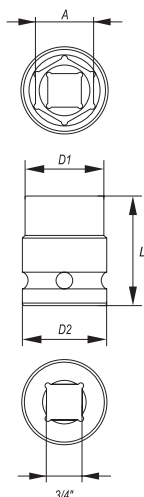

COLOR BOX



YATO	Ø A (mm)	D1 (mm)	D2 (mm)	L (mm)	PCS packing	PCS
YT-1070	19	32	40	50	16	64
YT-1071	21	35	40	50	16	64
YT-1072	22	38	40	50	16	64
YT-1073	23	38	40	50	16	64
YT-1074	24	40	40	50	16	64
YT-1075	25	40	40	50	16	64
YT-1076	26	40	40	50	16	64
YT-1077	27	42	42	53	16	64
YT-1078	28	44	44	53	16	64
YT-1079	29	46	44	53	12	48
YT-1080	30	46	44	53	12	48
YT-1082	32	48	44	56	12	48
YT-1083	33	48	44	56	8	32
YT-1084	34	50	44	56	8	32
YT-1085	35	50	44	56	6	24
YT-1086	36	52	44	56	6	24
YT-1088	38	56	44	57	6	24
YT-1091	41	60	44	57	5	20
YT-1092	42	61	44	57	4	16
YT-1093	43	63	44	57	4	16
YT-1096	46	66	44	62	3	12
YT-1100	50	71	54	72	3	12
YT-1102	52	74	54	72	2	8
YT-1105	55	78	54	74	2	8
YT-1110	60	84	54	74	2	8

GB Impact socket set
D Kraftschrauber-Einsätze
PL Zestaw nasadek uderowych
RUS Набор торцевых ударных головок

CZ Sada nástrčných kľúčů pro úderové utahováky
H Dugófej készlet ütvebehajtóhoz
RO Set chei tubulare pt. impact
F Set de douilles à choc

I Chiave a bussola esagonale per percussione
E Juego de boquillas de percusión cortas
CN 风动套筒组套



8 PCS
3/4"
19mm
CrMo
SCM-440
AS-DRIVE

3/4" (19.0 mm): 22, 24 mm (L=50 mm); 27, 30 mm (L=53 mm); 32, 36 mm (L=55 mm); 38, 41 mm (L=57 mm)

YATO	Ø	PCS
YT-1115	3/4" (19.0 mm)	6

3

GB Hexagonal deep impact socket
D Kraftschrauber-Einsatz, lang
PL Nasadka uderowa sześciokątna długa
RUS Головка ударная 6-гранная глубокая
CZ Šestiranný hluboký nástavec
H Hatszögű rátét mély
RO Cheie tubulară hexagonală de impact adâncă
F Douille profonde à choc
I Chiave a bussola esagonale per percussione
E Boquilla de percusión profunda
CN 六角风动长套筒

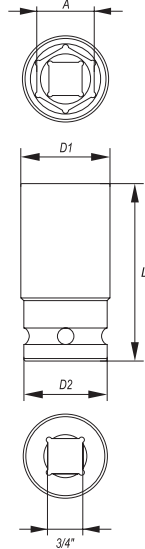

3/4"
19mm
CrMo
SCM-440
AS-DRIVE

YATO	Ø A (mm)	D1 (mm)	D2 (mm)	L (mm)	PCS packing	
YT-1119	19	32	44	90	9	36
YT-1121	21	35	44	90	9	36
YT-1122	22	38	44	90	9	36
YT-1123	23	38	44	90	9	36
YT-1124	24	40	44	90	9	36
YT-1127	27	42	44	90	9	36
YT-1128	28	44	44	90	8	32
YT-1129	29	44	44	90	8	32
YT-1130	30	46	44	90	7	28
YT-1132	32	48	44	90	7	28
YT-1133	33	50	44	90	6	24
YT-1134	34	51	44	90	6	24
YT-1135	35	52	44	90	6	24
YT-1136	36	54	44	90	6	24
YT-1138	38	56	44	90	6	24
YT-1141	41	60	44	90	5	20
YT-1142	42	61	44	90	4	16
YT-1143	43	63	44	90	3	12
YT-1146	46	66	44	90	3	12
YT-1148	48	68	44	90	2	8
YT-1150	50	71	54	90	2	8

COLOR BOX



GB Impact socket set
D Kraftschrauber-Einsätze
PL Zestaw nasadek uderowych
RUS Набор торцевых ударных головок

CZ Sada nástrčných kľúčů pro úderové utahováky
H Dugófej készlet ütvebehajtóhoz
RO Set chei tubulare pt. impact
F Set de douilles à choc

I Chiave a bussola esagonale per percussione
E Juego de boquillas de percusión cortas
CN 风动套筒组套



8 PCS
3/4"
19mm
CrMo
SCM-440
AS-DRIVE

3/4" (19.0 mm): 22, 24, 27, 30, 32, 36, 38, 41 mm (L=90 mm)

YATO	Ø	PCS
YT-1155	3/4" (19.0 mm)	4

GB Impact extension bar
D Verlängerung
PL Przedłużka uderowa
RUS Удлинитель ударный
CZ Prodlužovací přípravek
H Toldalék
RO Prelungitor
F Rallonge
I Prolunga per percussione
E Tubo de prolongación
CN 风动接杆

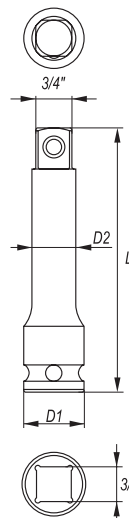

3/4"
19mm
CrMo
SCM-440

COLOR BOX



YATO	Ø	D1 (mm)	D2 (mm)	L (mm)	PCS packing	
YT-1160	3/4" (19.0 mm)	44	24	100	8	32
YT-1161	3/4" (19.0 mm)	44	24	175	10	20
YT-1162	3/4" (19.0 mm)	44	24	250	8	16
YT-1163	3/4" (19.0 mm)	44	24	330	6	12

GB Impact adapter
D Reduktion
PL Redukcja uderowa
RUS Переходник
CZ Redukce
H Redukció
RO Reducție
F Réduction
I Prolunga per percussione
E Reducción
CN 风动转换头

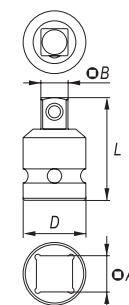

3/4"
19mm
CrV
50BV30

COLOR BOX



YATO	Ø	Ø	D (mm)	L (mm)	PCS packing	
YT-11671	3/4" (19.0 mm) (F)	1/2" (12.7 mm) (M)	44	55	12	48

GB Impact adapter
D Reduktion
PL Redukcja uderowa
RUS Переходник
CZ Redukce
H Redukció
RO Reducție
F Réduction
I Prolunga per percussione
E Reducción
CN 风动转换头

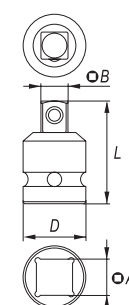

3/4"
19mm
CrMo
SCM-440

COLOR BOX



YATO	Ø	Ø	D (mm)	L (mm)	PCS packing	
YT-1168	3/4" (19.0 mm) (F)	1" (25.4 mm) (M)	44	63	12	48

- GB** Impact universal joint
D Gelenkstück
PL Przegub kulisty udarowy
RUS Кардан ударный
CZ Kloub kulový
H Univerzális csuklós csatlakozó
RO Adaptor
F Flector rond
I Prolunga per percussione
E Articulación redonda
CN 风动方向接头

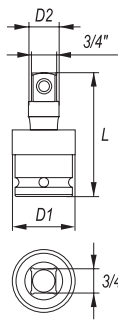

3/4"
19mm
CrMo
SCM-440

COLOR BOX



YATO	Ø	D1 (mm)	D2 (mm)	L (mm)	PCS packing	
YT-1164	3/4" (19.0 mm)	31	44	102	8	32

- GB** Hexagonal deep impact socket
D Kraftschrauber-Einsatz, lang
PL Nasadka udarowa sześciokątna długa
RUS Головка ударная 6-гранная глубокая
CZ Šestihranný hluboký nástavec
H Hatszögű rátét mély
RO Cheie tubulară hexagonală de impact adâncă
F Douille profonde à choc
I Chiave a bussola esagonale per percussione
E Boquilla de percusión profunda
CN 六角风动长套筒

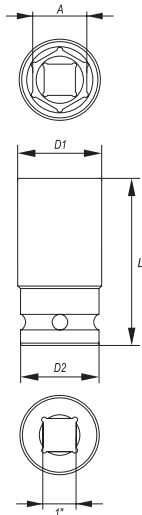

1"
25mm
CrMo
SCM-440
AS-DRIVE

COLOR BOX



YATO	Ø A (mm)	D1 (mm)	D2 (mm)	L (mm)	PCS packing	
YT-1175	27	46	54	90	6	24
YT-1176	30	50	54	90	6	24
YT-1177	32	52	54	90	6	24
YT-1178	33	54	54	90	6	24
YT-1179	36	57	54	90	6	24

- GB** Impact extension bar with adapter
D Verlängerung mit Adapter
PL Przedłużka udarowa z redukcją
RUS Удлинитель с редукцией
CZ Proloužení s redukcí
H Hosszabbító szár adapterrel
RO Bara extensie cu adaptor
F Rallonge avec reduction
I Prolunga per percussione con riduttore
E Tubo de prolongación con reductor
CN 风动转换接头

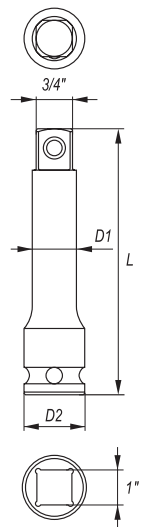

1"
25mm
CrMo
SCM-440

COLOR BOX



YATO	Ø A	Ø B	D1 (mm)	D2 (mm)	L (mm)	PCS packing	
YT-1169	1" (25.4 mm) (F)	3/4" (19.0mm) (M)	53	33	250	6	12

- GB** Hexagonal impact socket
D Kraftschrauber-Einsatz
PL Nasadka udarowa sześciokątna
RUS Головка ударная 6-гранная
CZ Šestihranný nástavec
H Hatszögű rátét
RO Cheie tubulară hexagonală de impact
F Douille à choc
I Chiave a bussola esagonale per percussione
E Boquilla de percusión
CN 六角风动套筒

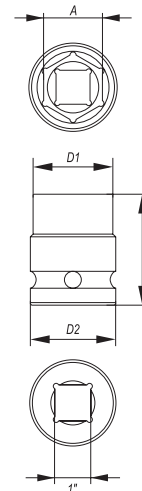

1"
25mm
CrMo
SCM-440
AS-DRIVE

COLOR BOX



YATO	Ø A (mm)	D1 (mm)	D2 (mm)	L (mm)	PCS packing	
YT-1180	24	42	54	59	6	24
YT-1183	27	46	54	59	6	24
YT-1184	28	47	54	59	6	24
YT-1185	29	48	54	60	6	24
YT-1186	30	49	54	60	6	24
YT-1187	32	52	54	61	6	24
YT-1188	33	53	54	61	6	24
YT-1189	34	54	54	61	6	24
YT-1191	36	57	54	65	6	24
YT-1193	38	60	54	65	5	20
YT-1194	41	63	54	65	4	16
YT-1196	46	69	54	73	3	12
YT-1197	48	72	54	73	2	8
YT-1198	50	75	54	73	2	8

- GB** Hexagonal impact socket
D Kraftschrauber-Einsatz
PL Nasadka udarowa sześciokątna
RUS Головка ударная 6-гранная
CZ Šestihranný nástavec
H Hatszögű rátét
RO Cheie tubulară hexagonală de impact
F Douille à choc
I Chiave a bussola esagonale per percussione
E Boquilla de percusión
CN 六角风动套筒

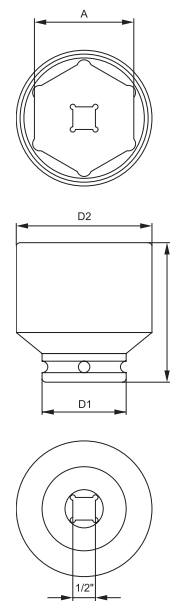

1/2" FOR FRONT HUB NUTS DO PIAST
12.5mm
CrMo
SCM-440
AS-DRIVE

COLOR BOX



YATO	Ø A (mm)	D1 (mm)	D2 (mm)	L (mm)	PCS packing	
YT-1029	52	44	71	72	3	12

- GB Bi-hexagonal impact socket
- D Zwölfkant-Kraftschrauber-Einsatz
- PL Nasadka uderowa dwunastokątna
- RUS Головка ударная 12-гранная
- CZ Vanáčtíhřanný nástavec
- H Dugófej, 12 lapú
- RO Cheie tubulară bihexagonală de impact
- F Douille à choc
- I Chiave a bussola esagonale per percussione
- E Boquilla bihexagonal de percusión
- CN 风动套筒

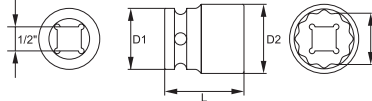

COLOR BOX



1/2"
12.5mm

FOR FRONT HUB NUTS DO PIAST

CrMo
SCM-440

AS-DRIVE

YATO	∅ A (mm)	D1 (mm)	D2 (mm)	L (mm)	PCS packing:	
YT-1027	24	30	34	39	10	120

- GB Bi-hexagonal deep impact socket
- D Zwölfkant-Kraftschrauber-Einsatz, lang
- PL Nasadka uderowa dwunastokątna długa
- RUS Головка ударная 12-гранная глубокая
- CZ Vanáčtíhřanný hluboký nástavec
- H Dugófej, mély, 12 lapú
- RO Cheie tubulară bihexagonală de impact adâncă
- F Douille à choc
- I Chiave a bussola esagonale per percussione
- E Boquilla bihexagonal de percusión profunda
- CN 风动套筒

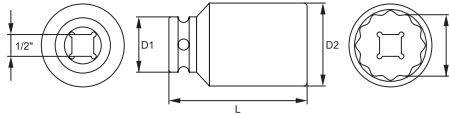

COLOR BOX



1/2"
12.5mm

FOR FRONT HUB NUTS DO PIAST

CrMo
SCM-440

AS-DRIVE

YATO	∅ A (mm)	D1 (mm)	D2 (mm)	L (mm)	PCS packing:	
YT-1028	33	30	45	75	8	32

- GB Bi-hexagonal impact socket
- D Zwölfkant-Kraftschrauber-Einsatz
- PL Nasadka uderowa dwunastokątna
- RUS Головка ударная 12-гранная
- CZ Vanáčtíhřanný nástavec
- H Dugófej, 12 lapú
- RO Cheie tubulară bihexagonală de impact
- F Douille à choc
- I Chiave a bussola esagonale per percussione
- E Boquilla bihexagonal de percusión
- CN 风动套筒

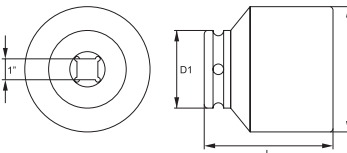

COLOR BOX



1"
25 mm

FOR FRONT HUB NUTS DO PIAST

CrMo

HRC
38-45

YATO	∅ A (mm)	D1 (mm)	D2 (mm)	L (mm)	
YT-11990	65	54	93	93	4
YT-11995	80	86	112	100	4
YT-11998	85	86	118	102	4

- GB Impact bit socket set
- D Schlagsteckschlüsselsatz
- PL Zestaw uderowych kluczy trzpieniowych
- RUS Набор ударных торцевых ключей
- CZ Souprava rázových zástrčných klíčů
- H Üthető dugókulcs bit - készlet
- RO Set chei de șoc cu bolt
- F Set de douilles à choc
- I Set di chiavi a bussola per percussione
- E Juego de llaves de mandril de impacto
- CN 风动套筒批头组套

BMC & COLOR SLEEVE



8
PCS

1/2"
12.5mm

CrMo

HRC
54



T30, T40, T45, T50, T55, T60, TORX T70, T80

6, 7, 8, 10, 12, 14, 17, 19 mm
HEX

YATO	∅	
YT-1065	1/2" (12.7 mm)	15

YATO	∅	
YT-1066	1/2" (12.7 mm)	15



RMS, RM5, RM7, RM8, RM10, RM11, RM12, RM13
RIBE

M5, M6, M8, M10, M12, M14, M16, M18
SPLINE

YATO	∅	
YT-1068	1/2" (12.7 mm)	15

YATO	∅	
YT-1069	1/2" (12.7 mm)	15

- GB Spline impact bit set
- D Schlagwerkzeugsatz - Spline
- PL Zestaw bitów uderowych - Spline
- RUS Набор ударных битов - Spline
- CZ Souprava bitů pro rázové utahováky - Spline
- H Ütő bit készlet - Spline
- RO Set tubulare de impact
- F Set d'embouts à choc
- I Set di chiavi a bussola per percussione Spline
- E Juego de las piezas de percusión - Spline
- CN 风动花键批头组套



BMC & COLOR BOX



6
PCS

3/4"
19 mm

SPLINE (XZN)

CrMo

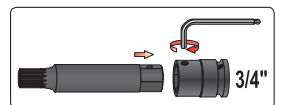

M12, M14, M16, M18 x 22 mm; (L=107 mm); CrMo;
3/4" (19.0 mm) x 22 mm; CrMo;



YATO	∅	
YT-1157	3/4" (19.0 mm)	8

Memo

4

Torque wrenches & torque multipliers Klucze dynamometryczne i wzmacniacze momentu



<p>Torque wrenches Klucze dynamometryczne</p>		<p>Torque angle gauges Kątomierze do dokręcania śrub</p>	
<p>..... 68-69</p>		<p>..... 70</p>	
<p>Beam torque wrenches Klucze dynamometryczne wychylne..... 68 Torque wrenches with metal handle Klucze dynamometryczne z metalową rączką..... 68 Torque wrenches with plastic handle Klucze dynamometryczne z plastikową rączką..... 68</p>	<p>Torque multipliers Wzmacniacze momentu</p>		<p>..... 70</p>

- GB** Beam torque wrench
D Beam-Typ-Drehmomentschlüssel
PL Klucz dynamometryczny wychylny
RUS Ключ динамометрический стрелочный
- CZ** Dynamometrický klíč
H Nyomatékkulcs
RO Cheie cu dinamometru
F Clé dynamométrique inclinée

- I** Chiave dinamometrica a quadrante
E Llave dinamométrica inclinada
CN 指针式扭力扳手

1/2"
12.5mm CrV
6140



YATO	Ø	Nm	Box
YT-07641	1/2" (12.7 mm)	0-300	16
YT-07642	1/2" (12.7 mm)	0-500	9

4

- GB** Torque wrench
D Drehmomentschlüssel
PL Klucz dynamometryczny
- RUS** Ключ динамометрический
CZ Dynamometrický klíč
H Nyomatékkulcs

- RO** Cheie cu dinamometru
F Clé dynamométrique
I Chiave dinamometrica

- E** Llave dinamométrica
CN 传统型可调式扭力扳手

1/2"
12.5mm 3/8"
10mm CrV
6140



YATO	Ø	Nm	L (mm)	Box
YT-0750	3/8" (9.5 mm)	20-110	366	20
YT-0760	1/2" (12.7 mm)	42-210	470	12

- GB** Torque wrench
D Drehmomentschlüssel
PL Klucz dynamometryczny
- RUS** Ключ динамометрический
CZ Dynamometrický klíč
H Nyomatékkulcs

- RO** Cheie cu dinamometru
F Clé dynamométrique
I Chiave dinamometrica

- E** Llave dinamométrica
CN 传统型可调式扭力扳手

3/8"
10mm TOLERANCE / TOLERANȚA
CW +- 4% CCW +- 4% ALLOY
STEEL
STAL
STOPOWA



YATO	Ø	Nm	L (mm)	Box
YT-07500	3/8" (9.5 mm)	10-60	383	16

- GB** Torque wrench
D Drehmomentschlüssel
PL Klucz dynamometryczny
RUS Ключ динамометрический
- CZ** Dynamometrický klíč
H Nyomatékkulcs
RO Cheie cu dinamometru
F Clé dynamométrique

- I** Chiave dinamometrica
E Llave dinamométrica
CN 传统型可调式扭力扳手

1/4"
6.3mm 1/2"
12.5mm 3/4"
19mm TOLERANCE / TOLERANȚA
CW +- 4% CCW +- 4% ALLOY
STEEL
STAL
STOPOWA



YATO	Ø	Nm	L (mm)	Box
YT-07511	1/4" (6.3 mm)	5-25	285	16
YT-07601	1/2" (12.7 mm)	65-335	523	16
YT-07611	1/2" (12.7 mm)	10-60	383	16
YT-07712	3/4" (19.0 mm)	80-400	700	16

- GB** Torque wrench
D Drehmomentschlüssel
PL Klucz dynamometryczny
- RUS** Ключ динамометрический
CZ Dynamometrický klíč
H Nyomatékkulcs

- RO** Cheie cu dinamometru
F Clé dynamométrique
I Chiave dinamometrica

- E** Llave dinamométrica
CN 传统型可调式扭力扳手

1"
25mm TOLERANCE / TOLERANȚA
≤ 500 Nm CW +- 3% CCW +- 3% > 500 Nm CW +- 4% CCW +- 4% CrMo42
CrMo30



YATO	Ø	Nm	L (mm)	Box
YT-07760	1" (25.4 mm)	160-800	1055	16
YT-07761	1" (25.4 mm)	200-1000	1055	16
YT-07762	1" (25.4 mm)	300-1500	2200	16

- GB** Torque wrench
D Drehmomentschlüssel
PL Klucz dynamometryczny
- RUS** Ключ динамометрический
CZ Dynamometrický klíč
H Nyomatékkulcs

- RO** Cheie cu dinamometru
F Clé dynamométrique
I Chiave dinamometrica

- E** Llave dinamométrica
CN 传统型可调式扭力扳手

1/4"
6.3mm CrV
6140



YATO	Ø	Nm	L (mm)	Box
YT-0751	1/4" (6.3 mm)	2-10	281	24

- GB** Torque wrench
D Drehmomentschlüssel
PL Klucz dynamometryczny
- RUS** Ключ динамометрический
CZ Dynamometrický klíč
H Nyomatékkulcs

- RO** Cheie cu dinamometru
F Clé dynamométrique
I Chiave dinamometrica

- E** Llave dinamométrica
CN 传统型可调式扭力扳手

1/4"
6.3mm TOLERANCE / TOLERANȚA
CW +- 3% CCW +- 3% CrMo42
CrMo30



YATO	Ø	Nm	L (mm)	Box
YT-07720	1/4" (6.3 mm)	1-5	240	40
YT-07721	1/4" (6.3 mm)	2-10	252	40
YT-07722	1/4" (6.3 mm)	2.5-12	290	16
YT-07723	1/4" (6.3 mm)	4-20	290	16

Torque wrenches & torque multipliers Klucze dynamometryczne i wzmacniacze momentu



GB Torque wrench
D Drehmomentschlüssel
PL Klucz dynamometryczny

RUS Ключ динамометрический
CZ Dynamometrický klíč
H Nyomatékkulcs

RO Cheie cu dinamometru
F Clé dynamométrique
I Chiave dinamometrica

E Llave dinamométrica
CN 传统型可调式扭力扳手

3/8"
10mm
TOLERANCE
TOLERANȚA
CW +-3%
CCW +-3%
CrMo42
CrMo30



YATO	Ø	Nm	L (mm)	Box
YT-07730	3/8" (9.5 mm)	6-30	318	16
YT-07731	3/8" (9.5 mm)	10-60	388	16
YT-07732	3/8" (9.5 mm)	20-100	443	16
YT-07733	3/8" (9.5 mm)	25-125	443	16



GB Torque wrench
D Drehmomentschlüssel
PL Klucz dynamometryczny

RUS Ключ динамометрический
CZ Dynamometrický klíč
H Nyomatékkulcs

RO Cheie cu dinamometru
F Clé dynamométrique
I Chiave dinamometrica

E Llave dinamométrica
CN 传统型可调式扭力扳手

1/2"
12.5mm
TOLERANCE
TOLERANȚA
CW +-3%
CCW +-3%
CrMo42
CrMo30



YATO	Ø	Nm	L (mm)	Box
YT-07740	1/2" (12.7 mm)	10-60	388	16
YT-07741	1/2" (12.7 mm)	20-100	443	16
YT-07742	1/2" (12.7 mm)	25-125	443	16
YT-07743	1/2" (12.7 mm)	40-200	468	16
YT-07744	1/2" (12.7 mm)	65-335	528	16



GB Torque wrench
D Drehmomentschlüssel
PL Klucz dynamometryczny

RUS Ключ динамометрический
CZ Dynamometrický klíč
H Nyomatékkulcs

RO Cheie cu dinamometru
F Clé dynamométrique
I Chiave dinamometrica

E Llave dinamométrica
CN 传统型可调式扭力扳手

3/4"
19mm
1/2"
12.5mm
CrV
6140



YATO	Ø	Nm	L (mm)	Box
YT-0761	1/2" (12.7 mm)	40-210	535	10
YT-0770	3/4" (19.0 mm)	100-500	865	4
YT-0771	3/4" (19.0 mm)	140-980	1230	2



YT-0771
• application: automotive service stations, trucks
• wrench and extension pipe designed to tighten screws in double wheels
• measurement tolerance +/- 3%

YT-0771
• назначение: сервис, автомобили ciężarowe
• лачение з przedłużką dostosowany do dokręcania śrub w kołach bliźniaczych
• dokładność pomiarowa +/- 3%

GB Torque wrench
D Drehmomentschlüssel
PL Klucz dynamometryczny

RUS Ключ динамометрический
CZ Dynamometrický klíč
H Nyomatékkulcs

RO Cheie cu dinamometru
F Clé dynamométrique
I Chiave dinamometrica

E Llave dinamométrica
CN 传统型可调式扭力扳手

3/4"
19mm
TOLERANCE
TOLERANȚA
CW +-3%
CCW +-3%
CrMo42
CrMo30



YATO	Ø	Nm	L (mm)	Box
YT-07750	3/4" (19.0 mm)	80-400	700	16
YT-07751	3/4" (19.0 mm)	100-500	855	16



GB Torque wrench
D Drehmomentschlüssel
PL Klucz dynamometryczny

RUS Ключ динамометрический
CZ Dynamometrický klíč
H Nyomatékkulcs

RO Cheie cu dinamometru
F Clé dynamométrique
I Chiave dinamometrica

E Llave dinamométrica
CN 传统型可调式扭力扳手

3/4"
19mm
TOLERANCE
TOLERANȚA
≤ 500 Nm CW +-3%
> 500 Nm CW +-4%
CCW +-3%
CCW +-4%
CrMo42
CrMo30



YATO	Ø	Nm	L (mm)	Box
YT-07752	3/4" (19.0 mm)	160-800	1055	16
YT-07753	3/4" (19.0 mm)	200-1000	1055	16



GB Torque wrench
D Drehmomentschlüssel
PL Klucz dynamometryczny

RUS Ключ динамометрический
CZ Dynamometrický klíč
H Nyomatékkulcs

RO Cheie cu dinamometru
F Clé dynamométrique
I Chiave dinamometrica

E Llave dinamométrica
CN 传统型可调式扭力扳手

3/4"
19mm
1/2"
12.5mm
CrV
6140



YATO	Ø	Nm	L (mm)	Box
YT-0754	1/2" (12.7 mm)	60-340	613	10
YT-0755	3/4" (19.0 mm)	200-1000	1234	2



GB Torque wrench
D Drehmomentschlüssel
PL Klucz dynamometryczny

RUS Ключ динамометрический
CZ Dynamometrický klíč
H Nyomatékkulcs

RO Cheie cu dinamometru
F Clé dynamométrique
I Chiave dinamometrica

E Llave dinamométrica
CN 传统型可调式扭力扳手

3/4"
19mm
TOLERANCE
TOLERANȚA
CW +-3%
CCW +-5%
HRC
48-52
CrV
6140



YATO	Ø	Nm	L (mm)	Box
YT-07711	3/4" (19.0 mm)	150-800	1170	2

BMC & COLOR SLEEVE



- GB Torque angle gauge
- D Winkelmesser zum Anziehen von Schrauben
- PL Kątomierz do dokręcania śrub
- RUS Угломер для подвёртывания болтов
- CZ Úhloměr k utahování šroubů
- H Nyomaték szögmérő
- RO Raportor pt. înşurubat şuruburi
- F Rapporteur à serrer les vis
- I Goniometro per il serraggio controllo
- E Calibrador para apretar tornillos
- CN 扭力角度规



1/2"
12.5mm 360° CrV



SLIDING CARD

YATO	
YT-0593	12/48

4

- GB Torque multiplier
- D Drehmomentverstärker
- PL Mechaniczny wzmacniacz momentu
- RUS Мультипликатор крутящего момента
- CZ Mechanický posilovač momentu
- H Nyomaték sokszorozó
- RO Antrenor cu amplificator de forta
- F Amplificateur de couple mécanique
- I Moltiplicatore di coppia
- E Mecanismo de reforzar el momento
- CN 3倍扭力倍增器

3/4" max. 900 Nm 1" max. 2700 Nm 3:1 CrMo 4140

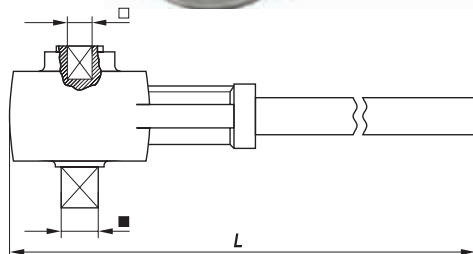

BMC & COLOR SLEEVE

YATO	F □	Tmax. (Nm)	M ■	Tmax. (Nm)	L (mm)	
YT-0781	3/4" (19.0 mm)	900	1" (25.4 mm)	2700	500	2

- GB Labor save wrench
- D Drehmomentverstärker
- PL Mechaniczny wzmacniacz momentu
- RUS Механический усилитель силы
- CZ Mechanický posilovač momentu
- H Nyomaték sokszorozó
- RO Antrenor cu amplificator de forta
- F Amplificateur de couple mécanique
- I Moltiplicatore di coppia
- E Mecanismo de reforzar el momento
- CN 扭力倍增器

1" 25mm 32,33mm 4200 Nm (max) I-1:3.8 II-1:5.8 CrV

- GB Labor save wrench
- D Drehmomentverstärker
- PL Mechaniczny wzmacniacz momentu
- RUS Механический усилитель силы
- CZ Mechanický posilovač momentu
- H Nyomaték sokszorozó
- RO Antrenor cu amplificator de forta
- F Amplificateur de couple mécanique
- I Moltiplicatore di coppia
- E Mecanismo de reforzar el momento
- CN 扭力倍增器

1" 25mm 32,33mm 5800 Nm (max) 1:6.6 CrV



BMC & COLOR SLEEVE



YATO	Ø	Nm	L (mm)	
YT-0782	1" (25.4 mm)	4200	330	1



BMC & COLOR SLEEVE



YATO	Ø	Nm	L (mm)	
YT-07822	1" (25.4 mm)	5800	380	1

Memo

5

Screwdrivers & screwdriver bits Wkrętaki i końcówki wkrętakowe



Screwdrivers, 3 color handle
Wkrętaki, trójkolorowa rączka

74-76



Slotted screwdrivers Wkrętaki płaskie.....	74
Phillips screwdrivers Wkrętaki krzyżakowe.....	74
Pozidrive screwdrivers Wkrętaki „Pozidrive”.....	74
Torx screwdrivers Wkrętaki „Torx”.....	74
Torx Security screwdrivers Wkrętaki „Torx Security”.....	74
Go-through screwdrivers Wkrętaki do pobijania.....	74
Screwdriver sets Komplety wkrętaków.....	75

Screwdrivers, 3 color handle
Wkrętaki, trójkolorowa rączka

77-78



Slotted screwdrivers Wkrętaki płaskie.....	77
Phillips screwdrivers Wkrętaki krzyżakowe.....	77
Pozidrive screwdrivers Wkrętaki „Pozidrive”.....	77
Torx screwdrivers Wkrętaki „Torx”.....	77
Torx Security screwdrivers Wkrętaki „Torx Security”.....	77
Screwdriver sets Komplety wkrętaków.....	77

Precision screwdrivers, 3 color handle
Wkrętaki precyzyjne, trójkolorowa rączka

78



Precision slotted screwdrivers Wkrętaki precyzyjne płaskie.....	78
Precision phillips screwdrivers Wkrętaki precyzyjne krzyżakowe.....	78
Precision Torx screwdrivers Wkrętaki precyzyjne „Torx”.....	78
Precision screwdriver sets Zestawy wkrętaków precyzyjnych.....	78

Insulated screwdrivers
Wkrętaki izolowane

79



Insulated slotted screwdrivers Wkrętaki izolowane płaskie.....	79
Insulated phillips screwdrivers Wkrętaki izolowane krzyżakowe.....	79
Insulated Pozidrive screwdrivers Wkrętaki izolowane „Pozidrive”.....	79
Insulated screwdriver sets Komplety wkrętaków izolowanych.....	79

Special screwdrivers & impact screwdrivers
Wkrętaki specjalne i udarowe

80-81



Ratchet screwdriver sets Wkrętaki z grzechotką.....	80
Impact screwdrivers Wkrętaki udarowe.....	81

Screwdriver bits
Kończówki wkrętakowe

81-85



Phillips screwdriver bits Kończówki wkrętakowe krzyżakowe.....	81
Torx screwdriver bits Kończówki wkrętakowe „Torx”.....	81
YATO NON-SLIP SYSTEM screwdriver bits Kończówki wkrętakowe „YATO NON-SLIP SYSTEM”.....	81
Screwdriver bit sets Zestawy końcówek wkrętakowych.....	82

Nut setters
Nasadki magnetyczne do wkrętarek

86



Screwdriver bit holders
Uchwyty do końcówek wkrętakowych

86



Hex & Torx keys & sets
Klucze imbusowe i zestawy

86-90



Insulated hex keys Klucze imbusowe izolowane.....	86
Hex keys with handle Klucze imbusowe z rękojeścią.....	87
T-handle keys & sets Klucze imbusowe typu „T” i zestawy.....	87
Hex keys & sets Klucze imbusowe i zestawy.....	88
Torx & Torx Security keys & sets Klucze „Torx”, „Torx Security” i zestawy.....	90
Plastic covered hex & Torx Security keys Klucze imbusowe powlekane.....	90

GB Screwdriver
D Schraubendreher
PL Wkrętak
RUS Отвёртка
CZ Šroubovák
H Csavarhúzó

RO Şurubelniţă
F Tournevis
I Cacciavite
E Destornillador
CN 螺丝刀

PLASTIC HANGER



PCS packing:



COLOR BOX



S2

HRC 58



YATO	⊖	L (mm)	PCS packing:	
YT-25900	2	75	12	96/384
YT-25901	3	75	12	96/384
YT-25902	3	100	12	96/384
YT-25903	3	150	12	60/240
YT-25904	4	100	12	96/384
YT-25905	4	150	12	96/384
YT-25906	4	200	12	96/384
YT-25907	5	75	12	60/240
YT-25908	5	100	12	60/240
YT-25909	5	150	12	60/240
YT-25910	6	38	12	60/240
YT-25911	6	100	12	36/144
YT-25912	6	150	12	36/144
YT-25913	6	200	12	36/144
YT-25914	8	150	6	24/96



5



YATO	⊕	L (mm)	PCS packing:	
YT-25920	PH0	75	12	96/384
YT-25921	PH0	100	12	96/384
YT-25922	PH1	38	12	60/240
YT-25923	PH1	75	12	60/240
YT-25924	PH1	100	12	60/240
YT-25925	PH1	150	12	60/240
YT-25926	PH1	200	12	36/144
YT-25927	PH1	300	6	24/96
YT-25928	PH2	38	12	60/240
YT-25929	PH2	100	12	36/144
YT-25930	PH2	150	12	36/144
YT-25931	PH2	200	12	36/144
YT-25932	PH2	300	6	24/96
YT-25933	PH3	150	6	24/96
YT-25934	PH3	200	6	24/96



YATO	⊕	L (mm)	PCS packing:	
YT-25940	PZ1	75	12	60/240
YT-25941	PZ1	100	12	60/240
YT-25942	PZ2	100	12	36/144
YT-25943	PZ2	150	12	36/144



YATO	⊗	L (mm)	PCS packing:	
YT-25950	T5	75	12	96/384
YT-25951	T6	75	12	96/384



YATO	⊗	L (mm)	PCS packing:	
YT-25952	T7	75	12	96/384
YT-25953	T8	75	12	96/384
YT-25954	T9	75	12	96/384
YT-25955	T10	100	12	60/240
YT-25956	T15	100	12	60/240
YT-25957	T20	100	12	60/240
YT-25958	T25	100	12	36/144
YT-25959	T27	100	12	36/144
YT-25960	T30	100	12	36/144
YT-25961	T40	100	6	24/96



GB Go-through screwdriver
D Schlagschrauber
PL Wkrętak do pobijania
RUS Отвёртка-било
CZ Šroubovák s úderným konce

H Beütő csavarhúzó
RO Şurubelniţă pt. fixare
F Tournevis à frapper
I Cacciavite per viti con intaglio

E Destornillador para dar golpes
CN 敲击螺丝批

PLASTIC HANGER



6 PCS



CrV 6150

HRC 52



YATO	⊖	L (mm)	PCS packing:	
YT-25985	6	100	6	24/96
YT-25986	6	150	6	24/96
YT-25987	6	200	6	24/96
YT-25988	6	250	6	24/96
YT-25989	8	150	6	24/72
YT-25990	8	200	6	24/72
YT-25991	8	250	6	24/72
YT-25992	8	300	6	24/72

YATO	⊕	L (mm)	PCS packing:	
YT-25993	PH2	100	6	24/96
YT-25994	PH2	150	6	24/96
YT-25995	PH3	150	6	24/72
YT-25996	PH3	200	6	24/72
YT-25997	PH3	250	6	24/72

Screwdrivers & screwdriver bits

Wkrętaki i końcówki wkrętakowe



- GB** Screwdriver set
D Schraubendrehersatz
PL Komplet wkrętaków
RUS Набор отвёрток
CZ Zámečnické šroubováky
H Lakatos csavarhózó
RO Șurubelnițe de lăcătușerie
F Set de tournevis
I Set cacciaviti
E Juego de destornilladores
CN 螺丝批组套

2 PCS	⊖	⊕		CrV 6150	HRC 52
----------	---	---	--	-------------	-----------



DOUBLE BLISTER

YATO	⊖	⊕	L (mm)	
YT-25998	6	PH2	150 150	6/36

- GB** Screwdriver set
D Schraubendrehersatz
PL Komplet wkrętaków
RUS Набор отвёрток
CZ Zámečnické šroubováky
H Lakatos csavarhózó
RO Șurubelnițe de lăcătușerie
F Set de tournevis
I Set cacciaviti
E Juego de destornilladores
CN 螺丝批组套

DOUBLE BLISTER



	S2	HRC 58
--	----	-----------



6
PCS



YATO	⊖	⊕	L (mm)	
YT-25965	3.0		75	6/24
	5.0		100	
	6.0		100	
		PH0	75	
		PH1	100	
		PH2	100	
			100	



8
PCS



YATO	⊖	⊕	L (mm)	
YT-25980	2.0		50	6/24
	2.4		50	
	6.0		38	
	6.0		100	
		PH0	50	
		PH1	50	
		PH2	38	
		PH2	100	
			100	



8
PCS



YATO	⊖	⊕	L (mm)	
YT-25966	5.0		100	6/12
	6.0		100	
	8.0		150	
		PH0	75	
		PH1	100	
		PH2	38	
		PH2	100	
		PH3	150	
			150	



12
PCS



YATO	⊖	⊕	⊗	L (mm)	
YT-25967	3.0			75	6/12
	5.0			75	
	6.0			38	
	6.0			150	
	8.0			150	
		PH0		75	
		PH1		75	
		PH2		38	
		PH2		100	
		PH3		150	
				150	
			SQ1	100	
			SQ2	100	
				100	

- GB Screwdriver set
 - D Schraubendrehersatz
 - PL Komplet wkrętek
 - RUS Набор отвёрток
 - CZ Zámečnické šroubováky
 - H Lakatos csavarhózó
- RO Șurubelnițe de lăcătușerie
 - F Set de tournevis
 - I Set cacciaviiti
 - E Juego de destornilladores
 - CN 螺丝批组套

15 PCS

S2

HRC 58



DOUBLE BLISTER

YATO		⊖	⊕		L (mm)	
YT-25981		1.5			50	6/24
		2.0			50	
		5.0			75	
		6.0			38	
		6.0			100	
		6.0			125	
			PH00		50	
			PH0		50	
			PH1		75	
			PH2		38	
			PH2		100	
				T5	50	
				T6	50	
				T7	50	
			T8	50		

- GB Screwdriver set
 - D Schraubendrehersatz
 - PL Komplet wkrętek
- RUS Набор отвёрток
 - CZ Zámečnické šroubováky
 - H Lakatos csavarhózó
- RO Șurubelnițe de lăcătușerie
 - F Set de tournevis
 - I Set cacciaviiti
- E Juego de destornilladores
 - CN 螺丝批组套

- GB 6 in 1 interchangeable screwdriver set
- D Umsteckschraubendreher
- PL Wkrętak z końcówkami dwustronnymi
- RUS Отвёртка с двухсторонними насадками
- CZ Šroubovák lancing z dvoustrannou koncovkou
- H Csavarhúzó kétvégű szárral
- RO Șurubelniță cu dublu capăt
- F Tournevis embouts réversibles
- I Cacciavite reversibile
- E Destornillador con punta de dos caras
- CN 6合1螺丝批组套

5.0 mm PH1

6.0 mm PH2

1/4" (6.3 mm)

5/16" (8 mm)

MAGNETIC TIP

S2



DOUBLE BLISTER

YATO		
YT-25971		12/96

- GB Mini pick & hook set
 - D Mini hacken set
 - PL Zestaw haczyków z rękojeścią
 - RUS Набор ключков с рукоятками
 - CZ Sada háčkových mini páčidel
 - H Mini ár és kámpó készlet
- RO Mini-set pt. extras garnituri
 - F Set de crochets
 - I Set ganci con maniglia
 - E Juego de palancas de hierro
 - CN 迷你拉拔器组套



4 PCS

HRC 40

SLIDING CARD

YATO		
YT-0843		12/72

9 PCS

S2



PLASTIC HANGER

YATO		⊖	⊕	L (mm)	
YT-25968		3.0		75	6/12
		5.0		75	
		6.0		100	
		6.0		150	
		6.0		150	
		8.0		150	
			PH0	75	
			PH1	75	
			PH2	100	
			PH2	150	

18 PCS

S2

HRC 58



PLASTIC HANGER & DOUBLE BLISTER

YATO		⊖	⊕		L (mm)	
YT-25982		2.4			50	6/12
		3.0			50	
		5.0			75	
		6.0			38	
		6.0			100	
		8.0			150	
			PH00		50	
			PH0		50	
			PH1		75	
			PH2		38	
			PH2		100	
			PH3		150	
				T5	50	
				T6	50	
			T7	50		
			T8	50		
			T9	50		
			T10	50		

Screwdrivers & screwdriver bits

Wkrętaki i końcówki wkrętakowe



GB Screwdriver
D Schraubendreher
PL Wkrętak
RUS Отвёртка
CZ Šroubovák
H Csavarhűző

RO Şurubelniţă
F Tournevis
I Cacciavite
E Destornillador
CN 螺丝刀

- application: industry
- can be used as go-through
- special highest quality alloy steel
- przeznaczenie: przemysł
- możliwość pobijania
- stal wysokostopowa

COLOR BOX



SVC55



⊖ HRC 58-62

YATO	⊖	L (mm)	PCS packing:	
YT-2601	3.0	75	12	240
YT-2606	4.0	100	12	240
YT-2608	5.5	100	12	240
YT-2609	5.5	150	12	240
YT-2610	5.5	200	12	240
YT-2612	6.5	38	12	240
YT-2613	6.5	100	12	240
YT-2614	6.5	150	12	240
YT-2615	6.5	200	12	240

⊖ HRC 55-59

YATO	⊖	L (mm)	PCS packing:	
YT-2618	8.0	150	6	120
YT-2602	3.0	100	12	240
YT-2633	3.0	300	12	240
YT-2604	4.0	75	12	240
YT-2634	4.0	400	12	240
YT-2635	5.0	300	12	120
YT-2636	5.0	400	12	120



⊕ HRC 58-62

YATO	⊕	L (mm)	PCS packing:	
YT-2640	PH0	75	12	240
YT-2642	PH1	75	12	240
YT-2643	PH1	100	12	240
YT-2644	PH1	150	12	240
YT-2645	PH1	200	12	240
YT-2647	PH2	38	12	240
YT-2648	PH2	100	12	240
YT-2649	PH2	150	12	240
YT-2650	PH2	200	12	240
YT-2653	PH3	150	6	120

⊕ HRC 55-59

YATO	⊕	L (mm)	PCS packing:	
YT-2641	PH1	38	12	240



⊕ HRC 58-62

YATO	⊕	L (mm)	PCS packing:	
YT-2661	PZ0	75	12	240
YT-2663	PZ1	100	12	240
YT-2665	PZ2	150	12	240
YT-2667	PZ3	150	6	240

⊕ HRC 55-59

YATO	⊕	L (mm)	PCS packing:	
YT-2657	PZ1	400	12	120
YT-2655	PZ2	38	12	240
YT-2658	PZ2	400	12	120



⊗ HRC 58-62

YATO	⊗	L (mm)	PCS packing:	
YT-2741	T5	75	12	240
YT-2742	T6	75	12	240

⊗ HRC 58-62

YATO	⊗	L (mm)	PCS packing:	
YT-2743	T7	75	12	240
YT-2744	T8	75	12	240
YT-2745	T9	75	12	240
YT-2746	T10	100	12	240
YT-2748	T15	100	12	240
YT-2750	T20	100	12	240
YT-2752	T25	100	12	240
YT-2753	T27	100	12	240
YT-2754	T30	100	12	240
YT-2756	T40	100	12	240

GB Screwdriver set
D Schraubendrehersatz
PL Komplet wkrętaków

RUS Набор отвёрток
CZ Zámečnické šroubováky
H Lakatos csavarhűző

RO Şurubelniţe de lăcătuşerie
F Set de tournevis
I Set cacciaviti

E Juego de destornilladores
CN 螺丝批组套

6
PCS



SVC55

HRC 58-62



DOUBLE
BLISTER



YATO	⊖	⊕	L (mm)	
YT-2668	5.5		100	6/24
	6.5		100	
	8.0		150	
		PH1	100	
		PH2	100	
		PH3	150	

GB Screwdriver set **RUS** Набор отвёрток **RO** Șurubelnițe de lăcătușerie **E** Juego de destornilladores
D Schraubendrehersatz **CZ** Zámečnické šroubováky **F** Set de tournevis **CN** 螺丝批组套
PL Komplet wkrętek **H** Lakatos csavarhúzó **I** Set cacciaviti

8 PCS
⊖
⊕
⊙
SVC M 55
HRC 58-62



DOUBLE BLISTER

YATO	⊖	⊕	L (mm)	⊞
YT-2670	4.0		100	4/16
	5.5		100	
	6.5		38	
	6.5		100	
		PH0	75	
		PH1	100	
		PH2	38	
		PH2	100	

GB Precision screwdriver **CZ** Šroubovák pro jemnou mechaniku **I** Cacciavite di precisione
D Präzisions-Schraubendreher **H** Műszerész csavarhúzó **E** Destornillador de precisión
PL Wkrętak precyzyjny **RO** Șurubelniță mecanică fină **CN** 螺丝批
RUS Отвёртка для точных работ **F** Tournevis de précision

S2
HRC 57-61



YATO	⊖	L (mm)	⊞
YT-25802	1.4	50	50/400
YT-25803	1.6	50	50/400
YT-25804	1.8	50	50/400
YT-25805	2.0	50	50/400
YT-25806	2.0	75	50/400
YT-25807	2.4	50	50/400
YT-25808	2.4	75	50/400
YT-25809	3.0	50	50/400
YT-25810	3.0	75	50/400
YT-25811	3.0	100	50/400

YATO	⊕	L (mm)	⊞
YT-25831	PH000	50	50/400
YT-25832	PH000	75	50/400
YT-25833	PH00	50	50/400
YT-25834	PH00	75	50/400
YT-25835	PH0	50	50/400
YT-25836	PH0	75	50/400
YT-25837	PH0	100	50/400
YT-25838	PH1	50	50/400
YT-25839	PH1	100	50/400
YT-25840	PH1	150	50/400

YATO	⊙	L (mm)	⊞
YT-25852	T5	50	50/400
YT-25853	T6	50	50/400
YT-25854	T7	50	50/400
YT-25855	T8	50	50/400
YT-25856	T9	50	50/400
YT-25857	T10	50	50/400

GB Precision screwdriver set **CZ** Šroubováky sada pro jemnou mechaniku **F** Set de tournevis de précision
D Präzisions-Feinmechanikersatz **H** Órás csavarhúzó készlet **I** Set cacciavite di precisione
PL Zestaw wkrętek precyzyjnych **RO** Set șurubelnițe **E** Destornilladores precisos
RUS Набор прецизионных отвёрток **CN** 螺丝批组套

PLASTIC BOX & DOUBLE BLISTER

S2
HRC 57-61



6 PCS



6 PCS



7 PCS



YATO	⊖	⊕	L (mm)	⊞
YT-25861	1.4		50	6/36
	2.0		50	
	2.4		50	
		PH00	50	
		PH0	50	
		PH1	50	

YATO	⊙	L (mm)	⊞
YT-25862	T5	50	6/36
	T6	50	
	T7	50	
	T8	50	
	T9	50	
	T10	50	

YATO	⊖	⊕	⊙	L (mm)	⊞
YT-25863	2.0			50	6/36
	3.0			50	
		PH00		50	
		PH0		50	
			T5	50	
			T6	50	
			T7	50	

GB Insulated screwdriver
D Isolierte Schraubendreher
PL Wkrętak izolowany
RUS Изолированная отвёртка
CZ Izolovaný šroubovák
H Szigetelt csavarhúzó

RO Şurubelniţă izolată
F Tournevis isolé
I Cacciavite isolato
E Destornillador aislado
CN 绝缘螺丝批



- application: industry
- VDE certificate
- przeznaczenie: przemysł
- certyfiikat VDE

1000 V	S2	HRC 56-60	
--------	----	-----------	--



YATO	⊖	L (mm)	
YT-2815	3.0	75	12/120
YT-2816	4.0	75	12/120
YT-2817	4.0	100	12/120
YT-2818	5.5	125	12/120
YT-2819	6.5	150	12/120
YT-2820	8.0	175	12/120



YATO	⊕	L (mm)	
YT-2821	PH0	60	12/120
YT-2822	PH1	80	12/120
YT-2823	PH2	100	12/120
YT-2824	PH3	150	12/120



YATO	⊕	L (mm)	
YT-2825	PZ1	80	12/120
YT-2826	PZ2	100	12/120

GB Insulated screwdriver set
D Isolierte Schraubendrehersatz
PL Komplet wkrętasków izolowanych
RUS Изолированная отвёртка - набор

CZ Izolované šroubováky
H Szigetelt csavarhúzó
RO Şurubelniţă izolată
F Set de tournevis isolés

I Set di cacciavite isolato
E Juego de destornilladores aislado
CN 绝缘螺丝批组套

- application: industry
- VDE certificate
- przeznaczenie: przemysł
- certyfiikat VDE

DOUBLE
BLISTER



1000 V	S2	HRC 56-60	
--------	----	-----------	--



5
PCS

7
PCS



YATO	⊖	⊕	L (mm)	
YT-2827	3.0		75	20/40
	4.0		100	
	5.5		125	
		PH1	80	
		PH2	100	

YATO	⊖	⊕	⊕	L (mm)	
YT-2828	3.0			75	20/40
	4.0			100	
	5.5			125	
			PH1	80	
			PH2	100	
			PZ1	80	
			PZ2	100	

GB Insulated changeable screwdriver set
D Schraubendreher Satz isoliert
PL Zestaw wkrętask z wymiennymi końcówkami izolowanymi

RUS Набор изолированных отвёрток
CZ Sada izolovaného nářadí
H Csavarhúzó kétvégű szárral
RO Set şurubelniţa cu biti, izolate

F Jeu d'outils isolés
I Set di cacciavite isolato
E Juego de destornilladores aislado
CN 绝缘螺丝批组套

1000V
VDE CERTIFICATE
EN 60900:2012

NYLON CASE
& POLYBAG



1000 V	HRC 54-61	
S2		



⊖ 2.0, 2.5, 3.0, 3.5, 4.0, 5.5, 6.5 (L=100 mm); S2;
 ⊕ PH0, PH1, PH2 (L=100 mm); S2;
 4x150 mm; 250V

⊖ 2.0, 2.5, 3.0, 3.5, 4.0, 5.5, 6.5 (L=100 mm); S2;
 ⊕ PH0, PH1, PH2 (L=100 mm); S2;
 ⊕ PZ0, PZ1, PZ2 (L=100 mm); S2;
 ⊗ T6, T8, T9, T10, T15, T20, T25, T27, T30 (L=100 mm); S2;
 ⊙ 2, 3, 4, 5, 6 (L=100 mm); S2;
 ⊖ R1, R2 (L=100 mm); S2;
 ⊗ 1, 2, 3, 4 (L=100 mm); S2;
 ⊕ 4, 6, 8, 10 (L=100 mm); S2;
 ⊙ 4, 6, 8, 10 (L=100 mm); S2;
 ⊖ M4, M5, M6 (L=100 mm); S2;
 4x150 mm; 250V

12
PCS



YATO	
YT-28290	24



YATO	
YT-28293	10

GB 22 in 1 interchangeable screwdriver set
D Umsteckerschraubendreher
PL Wkrętek z końcówkami dwustronnymi
RUS Отвёртка - двухсторонние насадки
CZ Šroubovák lancer z dvoustrannou koncovkou
H Csavarhúzó kétfélegű szárral

RO Şurubelniţă cu dublu capăt
F Tournevis + embouts 22 en 1
I Set cacciavite con punte reversibile
E Destornillador con punta dos caras
CN 22合一螺丝批组套

DOUBLE BLISTER



12 PCS
22 in 1



- ⊖ 4 mm x 5.5 mm (L=175/115 mm);
- ⊕ 6.5 mm x PH3 (L=175/115 mm);
- ⊕ PH1 x PH2 (L=175/115 mm);
- ⊕ PZ1 x PZ2 (L=175/115 mm);
- ⊖ 3 mm x 3 mm (L=175/115 mm);
- ⊖ 4 mm x 4 mm (L=175/115 mm);
- ⊖ 5 mm x 5 mm (L=175/115 mm);
- ⊖ 6 mm x 6 mm (L=175/115 mm);
- ⊕ T10 x T15 (L=175/115 mm);
- ⊕ T20 x T25 (L=175/115 mm);
- ⊕ T30 x T40 (L=175/115 mm)



YATO
YT-2797 6/12

GB Ratchet screwdriver set
D Ratschenschraubendreher-set mit einsätzen
PL Wkrętek z grzechotką, nasadkami i bitami
RUS Набор головок с трещеткой
CZ Ráčnový kloubový šroubovák s příslušenstvím
H Dugókulcs és bit készlet csukló
RO Set surubelnița
F Clé mixte à cliquet + embouts + douilles
I Set cacciavite a cricchetto con prese punta
E Juego con destornillador y carraca
CN 棘轮螺丝批组套



30 PCS
1/4" 6.3mm
CrV 6150
S2

- ⊖ 1/4" (6.3 mm): 3.5, 4.0, 5.5, 6.5 mm (L=25 mm);
- ⊕ 1/4" (6.3 mm): PH0, PH1, PH2, PH3 (L=25 mm);
- ⊕ 1/4" (6.3 mm): PZ0, PZ1, PZ2, PZ3 (L=25 mm);
- ⊖ 1/4" (6.3 mm): 4.0, 5.0, 6.0 mm (L=25 mm);
- ⊖ 1/4" (6.3 mm): 5, 6(x2), 7(x2), 8, 9(x2), 10(x2), 11, 13 mm; CrV 6150;
- ⊖ 1/4" (6.3 mm) x 1/4" (6.3 mm): (L=30 mm); ⊖ 1/4" (6.3 mm): (L= 30 mm)

DOUBLE BLISTER



YATO
YT-2798 6/36

GB Precision screwdriver with bits
D Schraubendreher und bit-satz
PL Wkrętek elastyczny z wymiennymi bitami
RUS Отвёртка с прецизионными битами
CZ Šroubovák ráčnový se sadou bitů
H Órás csavarhúzó-bit készlet
RO Surubelnița + set biti
F Tournevis élastique
I Cacciavite flessibile con punte intercambiabili
E Juego de piznas terminales para destornillador + mango
CN 可弯曲批头组套

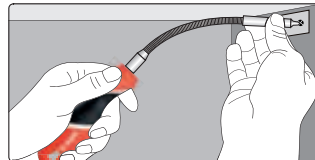

31 PCS
1/4" 6.3mm
S2 CrV 6150

- ⊖ 215 mm;
- ⊖ 1/4" (6.3 mm): 3.0, 3.5, 4.0, 5.0, 6.5 mm (L=25 mm);
- ⊕ 1/4" (6.3 mm): PH0, PH1, PH2, PH3 (L=25 mm);
- ⊕ 1/4" (6.3 mm): PZ0, PZ1, PZ2, PZ3 (L=25 mm);
- ⊕ 1/4" (6.3 mm): T10, T15 (L=25 mm);
- ⊖ 1/4" (6.3 mm): 2.0, 3.0, 4.0, 5.0, 6.0 mm (L=25 mm);
- ⊖ 1/4" (6.3 mm): 5.0, 6.0, 7.0, 8.0(x2), 9.0, 10.0, 11.0, 12.0, 13.0 mm

DOUBLE BLISTER



YATO
YT-25972 6/24

GB Ratchet screwdriver set
D Ratschenschraubendreher-Satz mit einsätzen
PL Wkrętek z grzechotką, przegubem i bitami
RUS Набор головок с трещеткой
CZ Ráčnový kloubový šroubovák s příslušenstvím
H Dugókulcs és bit készlet csukló

RO Set surubelnița
F Clé mixte à cliquet + embouts
I Set do chiavi a cricchetto e inserti
E Juego con destornillador y carraca
CN 棘轮螺丝批组套



42 PCS
1/4" 6.3mm
BITS x30 AISI S2
CrV 50BV30

- ⊖ 1/4" (6.3 mm): 5, 6, 7, 8, 9, 10, 11, 12, 13 mm;
- ⊖ 1/4" (6.3 mm) x 100 mm;
- ⊖ 1/4" (6.3 mm): CrV 50BV30; ⊖ H2, H2.5, H3, H4, H5, H6;
- ⊕ T10, T15, T20, T25, T27, T30, T40; ⊕ PH1, PH1, PH2, PH2, PH3, PH3;
- ⊖ 3, 4, 5, 6, 7 mm; ⊕ PZ1, PZ1, PZ2, PZ2, PZ3, PZ3

PLASTIC BOX & COLOR BOX



YATO
YT-2806 12

GB Impact screwdriver
D Schlagschrauber
PL Wkrętak udarowy

RUS Отвёртка ударная
CZ Narazový šroubovák kovový
H Csavarbehajtó, ütő üzemmóddal

RO Şurubelniţă metalică cu picuror
F Tournevis à choc
I Cacciavite percussione

E Destornillador de percusión
CN 冲击螺丝批组套

⊕ 1/2" ⊕ 12.5mm
⊕ 5/16" ⊕ 8.0mm

7
PCS

⊖

⊕

CrV
6150

5/16" (7.9 mm) ⊖ ⊕ ⊕ 1/2" (12.7 mm);
⊖ ⊕ 7, 8 mm (L=35 mm); 8mm (L=75 mm);
⊕ ⊕ PH2, PH3 (L=35 mm); PH2 (L=75 mm)



METAL CASE
& COLOR BOX

YATO

YT-2801

5/20

7
PCS

⊖

⊕

CrV
6150

5/16" (7.9 mm) ⊖ ⊕ ⊕ 1/2" (12.7 mm);
⊖ ⊕ 8 mm (L=35 mm); 8 mm (L=75 mm);
⊕ ⊕ PH3 (L=35 mm); PH1, PH2, PH3 (L=75 mm)



BMC & COLOR BOX

YATO

YT-2802

20

7
PCS

175
mm

⊖

⊕

CrV
6150

5/16" (7.9 mm) ⊖ ⊕ ⊕ 1/2" (12.7 mm);
⊖ ⊕ 7, 8 mm (L=35 mm); 8mm (L=75 mm);
⊕ ⊕ PH2, PH3 (L=35 mm); PH3 (L=75 mm)

PLASTIC BOX
& COLOR SLEEVE



YATO

YT-28003

8/16

15
PCS

160
mm

⊖

⊕

CrV
6150

5/16" (7.9 mm) ⊖ ⊕ ⊕ 1/2" (12.7 mm);
⊖ ⊕ 4, 5, 6, 8, 9 mm (L=35 mm); S2;
⊕ ⊕ PH1, PH2, PH3, PH4 (L=35 mm); S2;
⊖ ⊕ 4, 5, 6, 8 (L=35 mm); S2

METAL CASE
& COLOR BOX



YATO

YT-28015

16

GB Screwdriver bit set
D Schraubendreherbitsatz
PL Zestaw bitów do wkrętek udarowych
RUS Набор бит крестовых
CZ Sada bitů
H Bitkészlet
RO Truse bit
F Embouts à choc
I Set punte cacciavite
E Puntas de destornilladora
CN 冲击批头组套

CrV
6150



SLIDING
CARD

for / dla: YTO-2800, YTO-2801

YATO	⊕	⊖	L (mm)	⊖	PCS packing	⊖
YT-2810	PH2		36	5/16" (7.9 mm)	5	10/100
YT-2811	PH3		36	5/16" (7.9 mm)	5	10/100
YT-2812	PH2	8	36	5/16" (7.9 mm)	4	10/100
	PH3	10				

GB Screwdriver bit
D Schraubendreherbit
PL Końcówka śrubokrętowa
RUS Бит крестовая
CZ Šroubováková koncovka
H Csavarhúzóvég

RO Capăt pt. şurubelniţă
F Douille tournevis
I Punta del cacciavite
E Punta de destornilladora
CN 旋具头

SLIDING
CARD



YATO
NON-SLIP SYSTEM

⊕

GOLD FORGED
KUTE NAZIMNO

21.8Nm
max.

AISI
S2

HRC
58-62



YATO	⊕	L (mm)	⊖	⊖
YT-0485	PH2	100	1/4" (6.3 mm)	25/100
YT-0486	PH2	150	1/4" (6.3 mm)	25/100
YT-0487	PH2	200	1/4" (6.3 mm)	25/100

GB Screwdriver bit
 D Schraubendreherbit
 PL Końcówka śrubokrętu
 RUС Бит крестовая

CZ Šroubováková koncovka
 H Csavarhúzóvég
 RO Capăt pt. șurubelniță
 F Douille tournevis

I Punta del cacciavite
 E Punta de destornilladora
 CN 旋具头

SLIDING CARD



2 PCS
 1/4" (6.3mm)
 S2

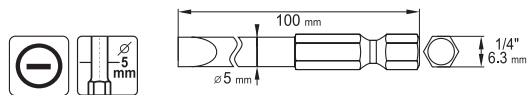

YATO	⊖	L (mm)	⊘	📦
YT-0484	4.0	100	1/4" (6.3 mm)	25/100
	5.0	100		

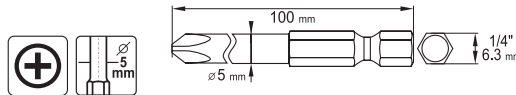

YATO	⊕	L (mm)	⊘	📦
YT-0459	PH00	100	1/4" (6.3 mm)	25/100
	PH0	100		

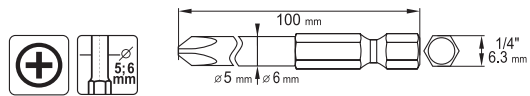

YATO	⊕	L (mm)	⊘	📦
YT-0488	PH1	100	1/4" (6.3 mm)	25/100
	PH2	100		

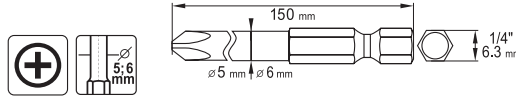

YATO	⊕	L (mm)	⊘	📦
YT-0489	PH1	150	1/4" (6.3 mm)	25/100
	PH2	150		

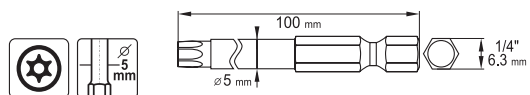

YATO	⊗	L (mm)	⊘	📦
YT-0490	T10	100	1/4" (6.3 mm)	25/100
	T25	100		

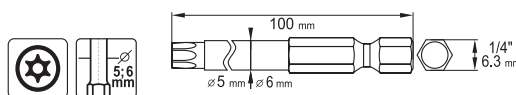

YATO	⊗	L (mm)	⊘	📦
YT-0491	T15	100	1/4" (6.3 mm)	25/100
	T27	100		
YT-0492	T20	100	1/4" (6.3 mm)	25/100
	T30	100		

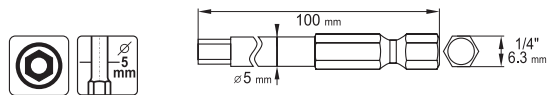

YATO	⊙	L (mm)	⊘	📦
YT-0494	3.0	100	1/4" (6.3 mm)	25/100
	5.0	100		

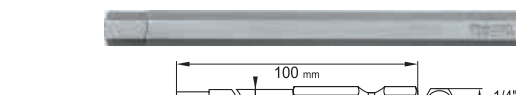
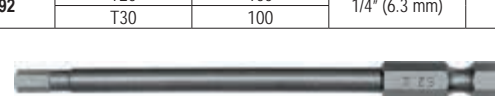

YATO	⊙	L (mm)	⊘	📦
YT-0495	4.0	100	1/4" (6.3 mm)	25/100
	6.0	100		

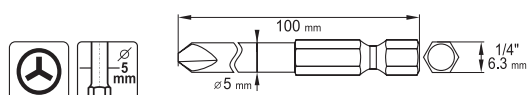

YATO	⊚	L (mm)	⊘	📦
YT-0493	#0	100	1/4" (6.3 mm)	25/100
	#1	100		
YT-0496	#1	100	1/4" (6.3 mm)	25/100
	#3	100		

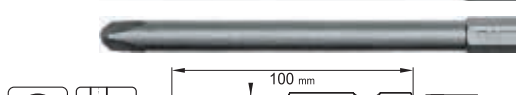
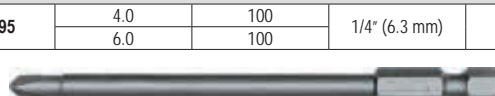

YATO	⊚	L (mm)	⊘	📦
YT-0497	#2	100	1/4" (6.3 mm)	25/100
	#4	100		

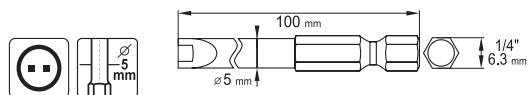

YATO	⊚	L (mm)	⊘	📦
YT-0498	#4	100	1/4" (6.3 mm)	25/100
	#8	100		

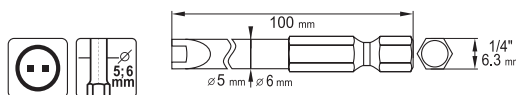

YATO	⊚	L (mm)	⊘	📦
YT-0499	#6	100	1/4" (6.3 mm)	25/100
	#10	100		

- GB Screwdriver bit set
- D Schraubendreherbitsatz
- PL Zestaw końcówek śrubokrętowych
- RUS Набор битов
- CZ Sada bitů
- H Bitkészlet
- RO Truse bit
- F Embouts de vissage
- I Set punte cacciavite
- E Puntas de destornilladora
- CN 旋具头组套



3/8" (9.5 mm): 4, 5, 6, 7, 8, 10, 12 mm (L=30 mm); 4, 5, 6, 7, 8, 10, 12 mm (L=75 mm); AISI S2;
 3/8" (9.5 mm): M5, M6, M8, M10, M12 (L=30 mm); M5, M6, M8, M10, M12 (L=75 mm); AISI S2;
 3/8" (9.5 mm): T20, T25, T30, T40, T45, T50, T55 (L=30 mm); T20, T25, T30, T40, T45, T50, T55 (L=75 mm); AISI S2;
 1/2" (12.7 mm) x 3/8" (9.5 mm),
 3/8" (9.5 mm) x 3/8" (9.5 mm); CrV 6150

21.8
max. Nm
AISI
S2
HRC
58-62

40
PCS

METAL CASE & COLOR BOX



YATO
YT-0400 10

7
PCS



3/8" (9.5 mm): T25, T30, T40, T45, T50, T55 (L=30 mm); AISI S2;
 1/2" (12.7 mm) x 3/8" (9.5 mm),
 CrV 6150

HANGING COLOR BOX



YATO
YT-0410 24/72

7
PCS



3/8" (9.5 mm): 4, 5, 6, 8, 10, 12 mm (L=30 mm); AISI S2;
 1/2" (12.7 mm) x 3/8" (9.5 mm),
 CrV 6150

HANGING COLOR BOX



YATO
YT-0412 24/72

6
PCS



3/8" (9.5 mm): M5, M6, M8, M10, M12 (L=30 mm); AISI S2;
 1/2" (12.7 mm) x 3/8" (9.5 mm),
 CrV 6150

HANGING COLOR BOX



YATO
YT-0414 24/72

7
PCS



3/8" (9.5 mm): T25, T30, T40, T45, T50, T55 (L=30 mm); AISI S2;
 1/2" (12.7 mm) x 3/8" (9.5 mm),
 CrV 6150

HANGING COLOR BOX



YATO
YT-0416 24/72

8
PCS



3/8" (9.5 mm): M5, M6, M7, M8, M10, M12, M14 (L=30 mm); AISI S2;
 1/2" (12.7 mm) x 3/8" (9.5 mm),
 CrV 6150

HANGING COLOR BOX



YATO
YT-0418 24/72

8
PCS



3/8" (9.5 mm): T20, T25, T30, T40, T45, T50, T55, T60, T70 (L=30 mm); T20, T25, T30, T40, T45, T50, T55, T60, T70 (L=75 mm); AISI S2;
 3/8" (9.5 mm): M4, M5, M6, M7, M8, M9, M10, M11, M12, M13, M14 (L=30 mm); M4, M5, M6, M7, M8, M9, M10, M11, M12, M13, M14 (L=75 mm); AISI S2;
 1/2" (12.7 mm) x 3/8" (9.5 mm),
 3/8" (9.5 mm) x 3/8" (9.5 mm); CrV 6150

42
PCS

METAL CASE & COLOR BOX



YATO
YT-0420 10

GB Hex key
D Sechskant-Stiftschlüssel
PL Klucz sześciokątny
RUS Шестигранник

CZ Imbusový klíč
H Imbisz kulcs
RO Cheie imbus
F Clé Allen

I Chiave a brugola
E Llave hexagonal
CN 内六角扳手

CrV

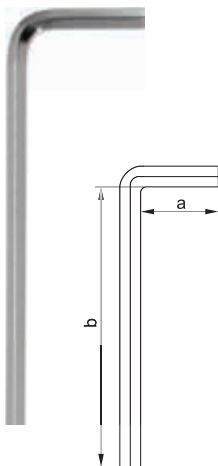

YATO	(mm)	a (mm)	b (mm)	
YT-05430	1.5	14	78	2000
YT-05431	2.0	16	83	2000
YT-05432	2.5	18	90	3000
YT-05433	3.0	20	100	3000
YT-05434	4.0	25	105	1000
YT-05435	4.5	27	110	500
YT-05436	5.0	27	116	600
YT-05437	5.5	30	128	500
YT-05438	6.0	32	137	500
YT-05439	7.0	34	150	240
YT-05440	8.0	36	155	200
YT-05441	9.0	38	165	100
YT-05442	10.0	40	170	100
YT-05443	12.0	47	210	60
YT-05444	14.0	57	236	50
YT-05445	17.0	63	250	30
YT-05446	19.0	70	280	20

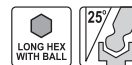
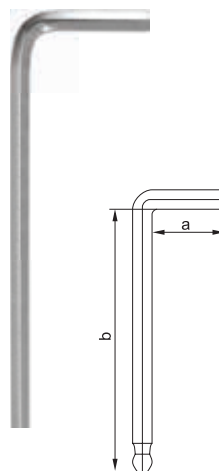

YATO	(mm)	a (mm)	b (mm)	
YT-05450	1.5	14	78	2000
YT-05451	2.0	16	83	2000
YT-05452	2.5	18	90	2000
YT-05453	3.0	20	100	3000
YT-05454	4.0	25	105	1000
YT-05455	4.5	27	110	800
YT-05456	5.0	27	116	600
YT-05457	5.5	30	128	500
YT-05458	6.0	32	137	300
YT-05459	7.0	34	150	240
YT-05460	8.0	36	155	240
YT-05461	9.0	38	165	100
YT-05462	10.0	40	170	100
YT-05463	12.0	47	210	50
YT-05464	14.0	57	236	60
YT-05465	17.0	63	250	30
YT-05466	19.0	70	280	20

GB TORX key
D TORX-Stiftschlüssel
PL Klucz TORX
RUS Ключ TORX

CZ Klíč TORX
H Kulcs TORX
RO Cheie TORX
F Clé TORX

I Chiave TORX
E Llave TORX
CN 内六角扳手

CrV

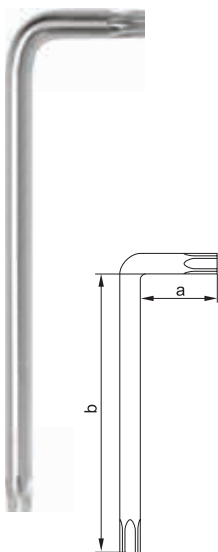

YATO	(mm)	a (mm)	b (mm)	
YT-05490	T6	16	66	2000
YT-05491	T7	16	71	2000
YT-05492	T8	16	80	2000
YT-05493	T9	16	80	2000
YT-05494	T10	17	86	2000
YT-05495	T15	17	90	2000
YT-05496	T20	19	95	1000
YT-05497	T25	20	100	1000
YT-05498	T27	21	105	1000
YT-05499	T30	24	114	500
YT-05501	T40	28	121	400
YT-05502	T45	30	132	200
YT-05503	T50	32	152	200

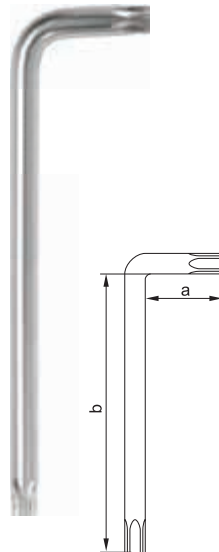

YATO	(mm)	a (mm)	b (mm)	
YT-05513	T9	16	80	2000
YT-05514	T10	17	86	2000
YT-05515	T15	17	90	2000
YT-05516	T20	19	95	1000
YT-05517	T25	20	100	1000
YT-05518	T27	21	105	1000
YT-05519	T30	24	114	500
YT-05520	T40	28	121	400
YT-05521	T45	30	132	200
YT-05522	T50	32	152	200

GB TORX key set
D TORX-Stiftschlüsselsatz
PL Zestaw kluczy TORX
RUS Набор ключей TORX
CZ Souprava klíčů TORX
H Kulcskészlet, TORX
RO Set de chei TORX
F Set de clés Allen
I Set di chiavi a brugola
E Juego de llaves TORX
CN 内六角扳手组套

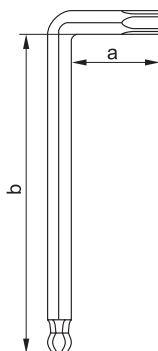

PLASTIC HANGER & SLIDING CARD



YATO	(mm)	a (mm)	b (mm)	
YT-05123	T9	18	85	60
	T10	18	90	
	T15	19	95	
	T20	20	100	
	T25	21	107	
	T27	23	115	
T30	25	123		
T40	27	132		

- GB** Hex key set
D Sechskant-Stiftschlüsselsatz
PL Zestaw kluczy imbusowych
RUS Набор шестигранных
CZ Imbusové klíče
H Imbisz kulcs
- RO** Chei imbus
F Set de clés Allen
I Set di chiavi a brugola
E Juego de llaves hex
CN 内六角扳手组套

PLASTIC HANGER
& SLIDING CARD

12
PCS

CrV
6150

S.A.E.

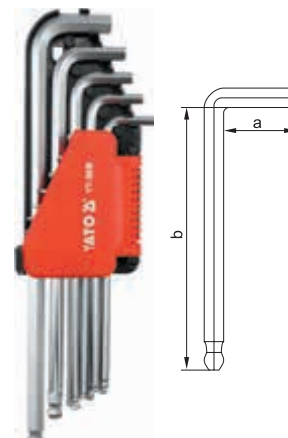
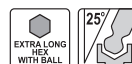
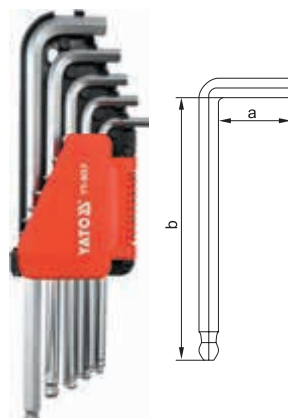
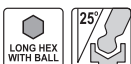
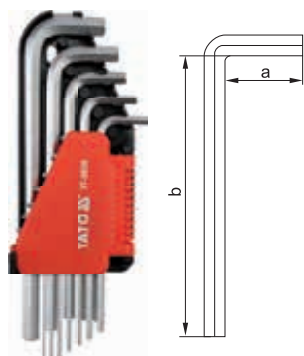

YATO	⊘	a (mm)	b (mm)	
YT-5835	1/16" (1.6 mm)	14	74	6/36
	5/64" (2.0 mm)	16	79	
	3/32" (2.4 mm)	17	83	
	7/64" (2.8 mm)	18	88	
	1/8" (3.2 mm)	19	93	
	9/64" (3.6 mm)	20	99	
	5/32" (4.0 mm)	21	105	
	3/16" (4.8 mm)	24	113	
	7/32" (5.6 mm)	25	122	
	1/4" (6.3 mm)	28	132	
5/16" (7.9 mm)	32	150		
3/8" (9.5 mm)	35	170		

YATO	⊘	a (mm)	b (mm)	
YT-5837	1/16" (1.6 mm)	14	74	6/36
	5/64" (2.0 mm)	16	79	
	3/32" (2.4 mm)	17	83	
	7/64" (2.8 mm)	18	88	
	1/8" (3.2 mm)	19	93	
	9/64" (3.6 mm)	20	99	
	5/32" (4.0 mm)	21	105	
	3/16" (4.8 mm)	24	113	
	7/32" (5.6 mm)	25	122	
	1/4" (6.3 mm)	28	132	
5/16" (7.9 mm)	32	150		
3/8" (9.5 mm)	35	170		

YATO	⊘	a (mm)	b (mm)	
YT-5838	1/16" (1.6 mm)	14	91	6/36
	5/64" (2.0 mm)	16	100	
	3/32" (2.4 mm)	17	110	
	7/64" (2.8 mm)	18	116	
	1/8" (3.2 mm)	19	123	
	9/64" (3.6 mm)	20	130	
	5/32" (4.0 mm)	21	132	
	3/16" (4.8 mm)	24	150	
	7/32" (5.6 mm)	25	165	
	1/4" (6.3 mm)	28	185	
5/16" (7.9 mm)	32	200		
3/8" (9.5 mm)	35	233		

- GB** Hex key set
D Sechskant-Stiftschlüsselsatz
PL Zestaw kluczy imbusowych
RUS Набор шестигранных
- CZ** Imbusové klíče
H Imbisz kulcs
RO Chei imbus
F Set de clés Allen

- I** Set di chiavi a brugola
E Juego de llaves hex
CN 内六角扳手组套

PLASTIC HANGER
& SLIDING CARD

HEX

CrV
6150

HRC
52-55

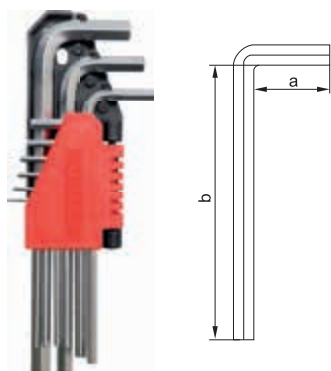

9
PCS

YATO	⊘ (mm)	a (mm)	b (mm)	
YT-0500	1.5	15	74	6/36
	2.0	16	81	
	2.5	18	88	
	3.0	21	95	
	4.0	23	109	
	5.0	28	121	
	6.0	31	135	
	8.0	35	157	
	10.0	39	174	

9
PCS

YATO	⊘ (mm)	a (mm)	b (mm)	
YT-0501	1.5	15	90	6/36
	2.0	16	96	
	2.5	18	112	
	3.0	21	125	
	4.0	23	142	
	5.0	28	157	
	6.0	31	180	
	8.0	35	201	
	10.0	39	225	

9
PCS

YATO	⊘ (mm)	a (mm)	b (mm)	
YT-0502	2.0	16	81	6/36
	2.5	18	88	
	3.0	21	95	
	4.0	23	109	
	5.0	28	121	
	6.0	31	135	
	7.0	33	145	
	8.0	35	157	
	10.0	39	174	

10
PCS

YATO	⊘ (mm)	a (mm)	b (mm)	
YT-0508	2.0	16	81	6/36
	2.5	18	88	
	3.0	21	95	
	4.0	23	109	
	5.0	28	121	
	6.0	31	135	
	7.0	33	145	
	8.0	35	157	
	10.0	39	174	
	12.0	42	180	

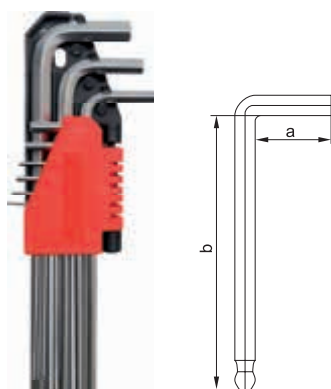

9
PCS

YATO	⊘ (mm)	a (mm)	b (mm)	
YT-0505	1.5	15	74	6/36
	2.0	16	81	
	2.5	18	88	
	3.0	21	95	
	4.0	23	109	
	5.0	28	121	
	6.0	31	135	
	8.0	35	157	
	10.0	39	174	

9
PCS

YATO	⊘ (mm)	a (mm)	b (mm)	
YT-0506	1.5	15	90	6/36
	2.0	16	96	
	2.5	18	112	
	3.0	21	125	
	4.0	23	142	
	5.0	28	157	
	6.0	31	180	
	8.0	35	201	
	10.0	39	225	

9
PCS

YATO	⊘ (mm)	a (mm)	b (mm)	
YT-0507	2.0	16	81	6/36
	2.5	18	88	
	3.0	21	95	
	4.0	23	109	
	5.0	28	121	
	6.0	31	135	
	7.0	33	145	
	8.0	35	157	
	10.0	39	174	

10
PCS

YATO	⊘ (mm)	a (mm)	b (mm)	
YT-0509	2.0	16	81	6/36
	2.5	18	88	
	3.0	21	95	
	4.0	23	109	
	5.0	28	121	
	6.0	31	135	
	7.0	33	145	
	8.0	35	157	
	10.0	39	174	
	12.0	42	180	

GB Hex key set
D Sechskant-Stiftschlüsselsatz
PL Zestaw kluczy imbusowych
RUS Набор шестигранников

CZ Imbusové klíče
H Imbisz kulcs
RO Chei imbus
F Set de clés Allen

I Set di chiavi a brugola
E Juego de llaves hex
CN 内六角扳手组套

POUCH



CrV
6150



8
PCS

YATO	∅ (mm)	a (mm)	b (mm)	Box
YT-0503	2.0	14	50	12/72
	2.5	16	53	
	3.0	17	60	
	4.0	21	66	
	5.0	22	74	
	6.0	27	81	
	8.0	32	93	
	10.0	38	104	

10
PCS

YATO	∅ (mm)	a (mm)	b (mm)	Box
YT-0504	1.5	12	43	12/72
	2.0	14	50	
	2.5	16	53	
	3.0	17	60	
	4.0	21	66	
	5.0	22	74	
	6.0	27	81	
	7.0	31	86	
	8.0	32	93	
	10.0	38	104	

GB Hex key set
D Sechskant-Stiftschlüsselsatz
PL Zestaw kluczy imbusowych
RUS Набор шестигранников
CZ Imbusové klíče
H Imbisz kulcs
RO Chei imbus
F Set de clés Allen
I Set di chiavi a brugola
E Juego de llaves hex
CN 内六角扳手组套

METAL CASE & COLOR SLEEVE



10
PCS



CrV
6150

HRC
52-55

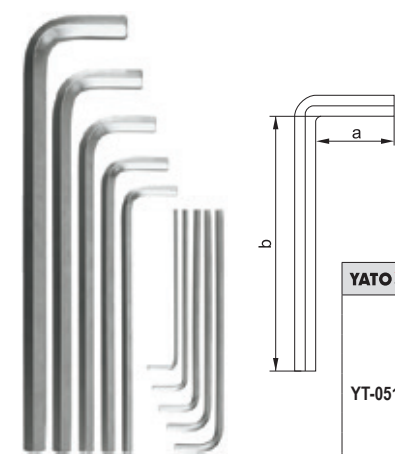

YATO	∅ (mm)	a (mm)	b (mm)	Box
YT-0519	3.0	20	125	5
	4.0	25	140	
	5.0	28	160	
	5.5	30	170	
	6.0	32	180	
	8.0	35	200	
	10.0	42	220	
	12.0	49	250	
	14.0	57	285	
	17.0	65	320	

GB TORX key set
D TORX-Stiftschlüsselsatz
PL Zestaw kluczy TORX
RUS Набор ключей TORX
CZ Souprava klíčů TORX
H Kulcskészlet, TORX
RO Set de chei TORX
F Set de clés Allen
I Set di chiavi a brugola
E Juego de llaves TORX
CN 内六角扳手组套

TORX TAMPERPROOF



PLASTIC HANGER & SLIDING CARD



CrV
6150

HRC
52-55

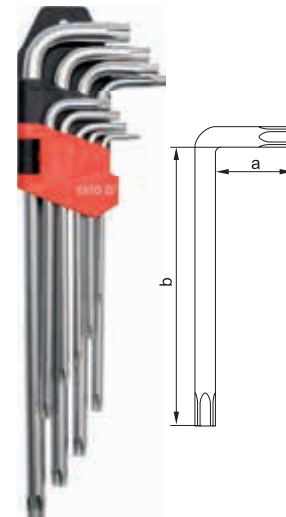

YATO	∅ (mm)	a (mm)	b (mm)	Box
YT-0511	T10	15	72	6/36
	T15	16	79	
	T20	17	86	
	T25	21	94	
	T27	24	107	
	T30	27	122	
	T40	32	133	
	T45	36	155	
	T50	38	174	

YATO	∅ (mm)	a (mm)	b (mm)	Box
YT-0512	T10	15	78	6/36
	T15	16	95	
	T20	19	109	
	T25	23	124	
	T27	26	143	
	T30	27	153	
	T40	32	180	
	T45	36	200	
	T50	41	222	

GB Hex key set
D Sechskant-Stiftschlüsselsatz
PL Zestaw kluczy imbusowych
RUS Набор шестигранников
CZ Imbusové klíče
H Imbisz kulcs
RO Chei imbus
F Set de clés Allen
I Set di chiavi a brugola
E Juego de llaves hex
CN 内六角扳手组套

PLASTIC HANGER



10
PCS



25%

S2

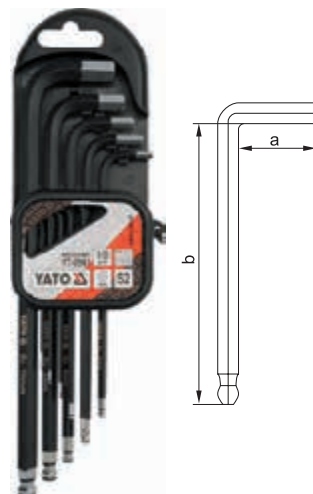

YATO	∅ (mm)	a (mm)	b (mm)	Box
YT-0560	1.27	12	73	12/48
	1.5	14	76	
	2.0	16	82	
	2.5	18	89	
	3.0	18	99	
	4.0	21	104	
	5.0	27	115	
	6.0	32	138	
	8.0	35	161	
	10.0	38	179	

YATO	∅ (mm)	a (mm)	b (mm)	Box
YT-0561	1.27	10	78	12/48
	1.5	12	89	
	2.0	15	98	
	2.5	17	110	
	3.0	19	124	
	4.0	23	140	
	5.0	28	159	
	6.0	32	179	
	8.0	36	198	
	10.0	50	232	

GB TORX key set
D TORX-Stiftschlüsselsatz
PL Zestaw kluczy TORX
RUS Набор ключей TORX
CZ Souprava klíčů TORX
H Kulcskészlet, TORX
RO Set de chei TORX
F Set de clés Allen
I Set di chiavi a brugola
E Juego de llaves TORX
CN 内六角扳手组套

TORX TAMPERPROOF



PLASTIC HANGER



S2

7
PCS

YATO	∅ (mm)	a (mm)	b (mm)	Box
YT-0562	T9	18	78	12/48
	T10	19	85	
	T15	19	93	
	T20	19	103	
	T25	22	113	
	T27	24	123	
	T30	26	132	

9
PCS

YATO	∅ (mm)	a (mm)	b (mm)	Box
YT-0563	T10	14	87	12/48
	T15	14	97	
	T20	16	108	
	T25	18	123	
	T27	23	137	
	T30	27	158	
	T40	30	177	
	T45	35	197	
	T50	41	216	

Memo

6

Pliers & pipe wrenches Szczypce i klucze do rur



Pliers, CrV Szczypce, CrV		95
--	---	----

Combination pliers Szczypce uniwersalne.....	95
Side cutting pliers Szczypce tnące, boczne.....	95
Long nose pliers Szczypce wydłużone, proste.....	95
Bent nose pliers Szczypce wydłużone, wygięte.....	95

Pliers Szczypce		95-96
----------------------------------	---	-------

Combination pliers Szczypce uniwersalne.....	95
Side cutting pliers Szczypce tnące, boczne.....	95
Long nose pliers Szczypce wydłużone, proste.....	95
Bent nose pliers Szczypce wydłużone, wygięte.....	95
Flat nose pliers Szczypce płaskie.....	96
Round nose pliers Szczypce okrągłe.....	96
Wire stripping pliers Szczypce do ściągania izolacji.....	96
End cutting pliers Szczypce tnące, czołowe.....	96

Pliers, CrV Szczypce, CrV		96
--	---	----

Combination pliers Szczypce uniwersalne.....	96
Side cutting pliers Szczypce tnące, boczne.....	96

Pliers Szczypce		96
----------------------------------	---	----

Combination pliers Szczypce uniwersalne.....	96
Side cutting pliers Szczypce tnące, boczne.....	96

Mini pliers Szczypce „Mini”		97
--	---	----

Combination pliers Szczypce uniwersalne.....	97
Side cutting pliers Szczypce tnące, boczne.....	97
Long nose pliers Szczypce wydłużone, proste.....	97
Bent nose pliers Szczypce wydłużone, wygięte.....	97
Flat nose pliers Szczypce płaskie.....	97
Round nose pliers Szczypce okrągłe.....	97
End cutting pliers Szczypce tnące, czołowe.....	97

Insulated pliers Szczypce izolowane		98
--	---	----

Combination pliers Szczypce uniwersalne.....	98
Side cutting pliers Szczypce tnące, boczne.....	98
Long nose pliers Szczypce wydłużone, proste.....	98
Wire stripping pliers Szczypce do ściągania izolacji.....	98
Water pump pliers Szczypce nastawne.....	98
Insulated flat nose pliers Klucze płaskie izolowane.....	98

Plastics & cables cutting pliers Szczypce do cięcia plastiku i kabli		99
---	---	----

Side cutting pliers Szczypce tnące, boczne.....	99
Long nose pliers Szczypce wydłużone, proste.....	99

Carpenter's pliers & tower pincers Obcęgi i szczypce		100
---	---	-----

Carpenter's pliers Obcęgi.....	100
Tower pincers Szczypce tynkarskie.....	100

Heavy duty side cutting pliers Szczypce tnące, boczne		100
--	---	-----

End cutting pliers Szczypce tnące czołowe		100
--	---	-----

Circlip pliers Szczypce Segera		101-102
---	---	---------

Lock grip pliers Szczypce zaciskowe		103-105
--	---	---------

Lock grip pliers Szczypce zaciskowe, uniwersalne.....	103
Welding locking pliers Szczypce zaciskowe, spawalnicze.....	104
Flat locking pliers Szczypce zaciskowe o szerokich szczękach.....	104
C-type welding locking pliers Szczypce zaciskowe, kłamrowe typu „C”.....	104
Chain locking pliers Szczypce zaciskowe z łańcuchem.....	104
Self-locking multi grip pliers Szczypce blacharskie.....	105



Profile connection & forming pliers
Szczypce do łączenia i kształtowania profili

105



Strap wrenches
Klucze do rur taśmowe

107



Water pump pliers
Szczypce nastawne

106



Chain pipe wrenches
Klucze do rur łańcuchowe

107



Pipe wrenches
Klucze do rur

106-107



Tweezers
Pęsety

107



GB Combination pliers
D Kombinationszange
PL Szczypce uniwersalne
RUS Плоскогубцы универсальные
CZ Kleště kombinované
H Kombináltfogó

RO Patent universal
F Pince universelle
I Pinze universali
E Alicates universales
CN 钢丝钳

160 mm	180 mm	200 mm
HRC 44-50 BODY	HRC 58-62 CUTTER	CrV 55
DIN 5746		



- application: industry
- induction hardening
- przeznaczenie: przemysł
- hartowane indukcyjnie

YATO	L (mm)	Box
YT-1940	160	6/60
YT-1941	180	6/60
YT-1942	200	6/36

GB Diagonal side cutting pliers
D Seitenschneider
PL Szczypce tnące boczne
RUS Бокорезы
CZ Řezací kleště boční
H Oldal csípőfogó

RO Olește tăietor
F Pince à coupe latérale
I Pinze taglianti laterali
E Alicates corte lateral
CN 斜嘴钳

160 mm	190 mm	HRC 44-50 BODY
HRC 58-62 CUTTER	CrV 55	DIN 5746



- application: industry
- induction hardening
- przeznaczenie: przemysł
- hartowane indukcyjnie

YATO	L (mm)	Box
YT-1947	160	6/60
YT-1948	190	6/60

GB Long nose pliers
D Radiozange
PL Szczypce wydłużone proste
RUS Тонкогубцы прямые
CZ Prodloužené kleště rovné
H Rádiófogó, egyenes

RO Clește cu vârf ascuțit
F Pince prolongée
I Pinze lunghe diritte
E Alicates de punta
CN 尖嘴钳

160 mm	200 mm	HRC 44-50 BODY
HRC 58-62 CUTTER	CrV 55	DIN 5746



- application: industry
- induction hardening
- przeznaczenie: przemysł
- hartowane indukcyjnie

YATO	L (mm)	Box
YT-1943	160	6/60
YT-1944	200	6/60

GB Bent nose pliers
D Telefonzange
PL Szczypce wydłużone wygięte
RUS Тонкогубцы изогнутые
CZ Prodloužené kleště ohnuté
H Rádió - és telefonfogó, hajlított

RO Clește cu vârf ascuțit indoit
F Pince prolongée cambrée
I Pinze a punte mezzo tonde
E Alicates de punta curvos
CN 弯嘴钳

160 mm	200 mm	HRC 44-50 BODY
HRC 58-62 CUTTER	CrV 55	DIN 5746



- application: industry
- induction hardening
- przeznaczenie: przemysł
- hartowane indukcyjnie

YATO	L (mm)	Box
YT-1945	160	6/60
YT-1946	200	6/60

GB Combination pliers
D Kombinationszange
PL Szczypce uniwersalne
RUS Плоскогубцы универсальные
CZ Kleště kombinované
H Kombináltfogó

RO Patent universal
F Pince universelle
I Pinze universali
E Alicates universales
CN 钢丝钳

160 mm	180 mm	200 mm
		NICKEL IRON FINISH
DIN 5746		



- application: industry
- induction hardening
- przeznaczenie: przemysł
- hartowane indukcyjnie

YATO	L (mm)	Box
YT-2006	160	6/60
YT-2007	180	6/60
YT-2008	200	6/36

GB Diagonal side cutting pliers
D Seitenschneider
PL Szczypce tnące boczne
RUS Бокорезы
CZ Řezací kleště boční
H Oldal csípőfogó

RO Olește tăietor
F Pince à coupe latérale
I Pinze taglianti laterali
E Alicates corte lateral
CN 斜嘴钳

160 mm	180 mm	
DIN 5746	NICKEL IRON FINISH	



- application: industry
- induction hardening
- przeznaczenie: przemysł
- hartowane indukcyjnie

YATO	L (mm)	Box
YT-2036	160	6/60
YT-2037	180	6/60

GB Long nose pliers
D Radiozange
PL Szczypce wydłużone proste
RUS Тонкогубцы прямые
CZ Prodloužené kleště rovné
H Rádiófogó, egyenes

RO Clește cu vârf ascuțit
F Pince prolongée
I Pinze lunghe diritte
E Alicates de punta
CN 尖嘴钳

160 mm	200 mm	
DIN 5746	NICKEL IRON FINISH	



- application: industry
- induction hardening
- przeznaczenie: przemysł
- hartowane indukcyjnie

YATO	L (mm)	Box
YT-2016	160	6/60
YT-2018	200	6/60

GB Bent nose pliers
D Telefonzange
PL Szczypce wydłużone wygięte
RUS Тонкогубцы изогнутые
CZ Prodloužené kleště ohnuté
H Rádió - és telefonfogó, hajlított

RO Clește cu vârf ascuțit indoit
F Pince prolongée cambrée
I Pinze a punte mezzo tonde
E Alicates de punta curvos
CN 弯嘴钳

160 mm	200 mm	
DIN 5746	NICKEL IRON FINISH	



- application: industry
- induction hardening
- przeznaczenie: przemysł
- hartowane indukcyjnie

YATO	L (mm)	Box
YT-2026	160	6/60
YT-2028	200	6/60

- GB** Flat nose pliers
D Elektrikerflachzange
PL Szczypce płaskie
RUS Утконосы
CZ Prodloužené kleště rovné
H Rádiófógó, egyenes

- RO** Clește cu vârf ascuțit
F Pince plate
I Pinze piate
E Alicates de bocas planas
CN 平嘴钳

160 mm **DIN 5745**

NICKEL IRON FINISH



HALF DOUBLE BLISTER

YATO	L (mm)	
YT-2029	160	6/60

- GB** Round nose pliers
D Rundzange
PL Szczypce okrągłe
RUS Круглогубцы
CZ Kleště kulaté
H Kerekcsőrű fogó

- RO** Patent rotund
F Pince ronde
I Pinze tonde
E Alicates de punta redonda
CN 圆嘴钳

160 mm **DIN 5745**

NICKEL IRON FINISH



HALF DOUBLE BLISTER

YATO	L (mm)	
YT-2030	160	6/60

- GB** Wire stripping pliers
D Abisolierzange
PL Szczypce do ściągania izolacji
RUS Пассатижи для зачистки проводов
CZ Kleště odizolovací na drát
H Blankoló fogó
RO Decablator

- F** Pince à l'isolation
I Pinze spelafili
E Pinzas pelacables
CN 剥线钳

160 mm **DIN 5745**

NICKEL IRON FINISH



HALF DOUBLE BLISTER

YATO	L (mm)	
YT-2031	160	6/60

- GB** End cutting pliers
D Vornscheider
PL Szczypce tnące czolowe
RUS Кусачки торцевые
CZ Kleště štipací čelní
H Homlokcsípő fogó
RO Clește relezat

- F** Coupe devant
I Pinza a taglio laterale
E Cortacables frontales
CN 顶切钳

160 mm **180 mm**

DIN 5748 **NICKEL IRON FINISH**



HALF DOUBLE BLISTER

YATO	L (mm)	
YT-2066	160	6/60
YT-2067	180	6/60

- GB** Combination pliers
D Kombinationszange
PL Szczypce uniwersalne
RUS Плоскогубцы универсальные
CZ Kleště kombinované
H Kombináltfogó

- RO** Patent universal
F Pince universelle
I Pinze universali
E Alicates universales
CN 钢丝钳

160 mm **180 mm** **200 mm**

CrV **HRC 55-62**



HALF DOUBLE BLISTER

YATO	L (mm)	
YT-6600	160	6/60
YT-6601	180	6/60
YT-6602	200	6/36

- GB** Diagonal side cutting pliers
D Seitenschneider
PL Szczypce tnące boczne
RUS Бокорезы
CZ Řezací kleště boční
H Oldal csípőfogó

- RO** Olește tăietor
F Pince à coupe latérale
I Pinze taglianti laterali
E Alicates corte lateral
CN 斜嘴钳

160 mm **180 mm**

CrV **HRC 55-62**



HALF DOUBLE BLISTER

YATO	L (mm)	
YT-6610	160	6/60
YT-6611	180	6/60

- GB** Diagonal side cutting pliers
D Seitenschneider
PL Szczypce tnące boczne
RUS Бокорезы
CZ Řezací kleště boční
H Oldal csípőfogó
RO Olește tăietor
F Pince à coupe latérale
I Pinze taglianti laterali
E Alicates corte lateral
CN 斜嘴钳



HALF DOUBLE BLISTER

180 mm **CrV** **HRC 55-62**

YATO	L (mm)	
YT-6612	180	6/60

- GB** Combination pliers
D Kombinationszange
PL Szczypce uniwersalne
RUS Плоскогубцы универсальные
CZ Kleště kombinované
H Kombináltfogó

- RO** Patent universal
F Pince universelle
I Pinze universali
E Alicates universales
CN 钢丝钳

160 mm **200 mm**

HIGH LEVERAGE ZWIERSZONA SIŁA NACISKU



HALF DOUBLE BLISTER

YATO	L (mm)	
YT-6581	160	6/60
YT-6582	200	6/36

- GB** Diagonal side cutting pliers
D Seitenschneider
PL Szczypce tnące boczne
RUS Бокорезы
CZ Řezací kleště boční
H Oldal csípőfogó

- RO** Olește tăietor
F Pince à coupe latérale
I Pinze taglianti laterali
E Alicates corte lateral
CN 斜嘴钳

160 mm

HIGH LEVERAGE ZWIERSZONA SIŁA NACISKU



HALF DOUBLE BLISTER

YATO	L (mm)	
YT-6583	160	6/60

GB Combination pliers
D Kombinationszange
PL Szczypce uniwersalne
RUS Плоскогубцы универсальные
CZ Kleště kombinované
H Kombináltfogó
RO Patent universal
F Pince universelle

I Pinze universali
E Alicates universales
CN 钢丝钳

115 mm NICKEL IRON FINISH

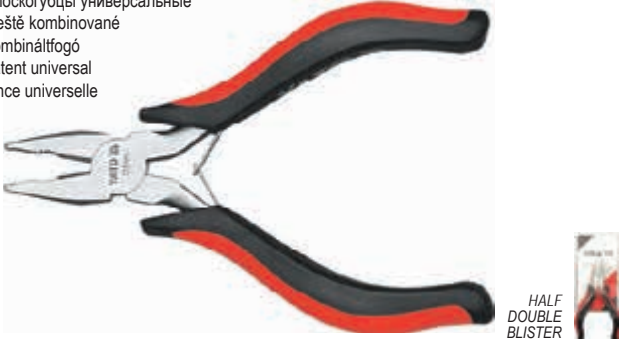

HALF DOUBLE BLISTER

YATO	L (mm)	
YT-2080	115	6/120

GB Diagonal side cutting pliers
D Seitenschneider
PL Szczypce tnące boczne
RUS Бокорезы
CZ Rezací kleště boční
H Oldal csípőfogó
RO Olește tăietor
F Pince à coupe latérale

I Pinze taglianti laterali
E Alicates corte lateral
CN 斜嘴钳

115 mm NICKEL IRON FINISH



HALF DOUBLE BLISTER

YATO	L (mm)	
YT-2081	115	6/120

GB Long nose pliers
D Radiozange
PL Szczypce wydłużone proste
RUS Тонкогубцы прямые
CZ Prodloužené kleště rovné
H Rádiófogó, egyenes

RO Clește cu vârf ascuțit
F Pince prolongée
I Pinze lunghe diritte
E Alicates de punta
CN 尖嘴钳

115 mm NICKEL IRON FINISH



HALF DOUBLE BLISTER

YATO	L (mm)	
YT-2083	115	6/120

GB Bent nose pliers
D Telefonzange
PL Szczypce wydłużone wygięte
RUS Тонкогубцы изогнутые
CZ Prodloužené kleště ohnuté
H Rádió- és telefonfogó, hajlított

RO Clește cu vârf ascuțit îndoit
F Pince prolongée cambrée
I Pinze a punte mezzo tonde
E Alicates de punta curvos
CN 弯嘴钳

115 mm NICKEL IRON FINISH



HALF DOUBLE BLISTER

YATO	L (mm)	
YT-2084	115	6/120

GB Flat nose pliers
D Elektrikerflachzange
PL Szczypce płaskie
RUS Утконосы
CZ Prodloužené kleště rovné
H Rádiófogó, egyenes

RO Clește cu vârf ascuțit
F Pince plate
I Pinze piatte
E Alicates de bocas planas
CN 平嘴钳

115 mm NICKEL IRON FINISH



HALF DOUBLE BLISTER

YATO	L (mm)	
YT-2085	115	6/120

GB Round nose pliers
D Rundzange
PL Szczypce okrągłe
RUS Круглогубцы
CZ Kleště kulaté
H Kerekcsőrű fogó

RO Patent rotund
F Pince ronde
I Pinze tonde
E Alicates de punta redonda
CN 圆嘴钳

115 mm NICKEL IRON FINISH



HALF DOUBLE BLISTER

YATO	L (mm)	
YT-2086	115	6/120

GB End cutting pliers
D Vornschnaider
PL Szczypce tnące czołowe
RUS Кусачки торцевые
CZ Kleště štípačí čelní
H Homlokcsípő fogó
RO Clește retezat
F Coupe devant
I Pinza a taglio laterale
E Cortacables frontales
CN 顶切钳

115 mm NICKEL IRON FINISH



HALF DOUBLE BLISTER

YATO	L (mm)	
YT-2082	115	6/120

GB Combination pliers
D Kombinationszange
PL Szczypce uniwersalne
RUS Плоскогубцы универсальные
CZ Kleště kombinované
H Kombináltfogó
RO Patent universal
F Pince universelle
I Pinze universali
E Alicates universales
CN 钢丝钳

160 mm 180 mm 200 mm CrV 1000 V



HALF
DOUBLE
BLISTER

YATO	L (mm)	
YT-21151	160	6/36
YT-21152	180	6/36
YT-21153	200	6/36

1000V
 VDE CERTIFICATE
 EN 60900:2012

GB Diagonal side cutting pliers
D Seitenschneider
PL Szczypce tnące boczne
RUS Бокорезы
CZ Řezací kleště boční
H Oldal csípőfogó
RO Olește tăietor
F Pince à coupe latérale
I Pinze taglianti laterali
E Alicates corte lateral
CN 斜嘴钳

160 mm 180 mm CrV 1000 V



HALF
DOUBLE
BLISTER

YATO	L (mm)	
YT-21158	160	6/36
YT-21159	180	6/36

1000V
 VDE CERTIFICATE
 EN 60900:2012

GB Long nose pliers
D Radiozange
PL Szczypce wydłużone proste
RUS Тонкогубцы прямые
CZ Prodloužené kleště rovné
H Rádiófogó, egyenes
RO Clește cu vârf ascuțit
F Pince prolongée
I Pinze lunghe diritte
E Alicates de punta
CN 尖嘴钳

160 mm 200 mm CrV 1000 V



HALF
DOUBLE
BLISTER

YATO	L (mm)	
YT-21154	160	6/36
YT-21155	200	6/36

1000V
 VDE CERTIFICATE
 EN 60900:2012

GB Wire stripping pliers
D Abisolierzange
PL Szczypce do ściągania izolacji
RUS Пасатижи для зачистки проводов
CZ Kleště odizolovací na drát
H Blankoló fogó
RO Decablator
F Pince à l'isolation
I Pinze spelafili
E Pinzas pelacables
CN 剥线钳

160 mm CrV 1000 V



HALF
DOUBLE
BLISTER

YATO	L (mm)	
YT-21160	160	6/36

1000V
 VDE CERTIFICATE
 EN 60900:2012

GB Water pump pliers
D Wasserpumpenzange
PL Szczypce nastawne
RUS Клещи переставные
CZ Keleště siko
H Vízpumpafogó
RO Clește papagal
F Pince réglable
I Pinze regolabili
E Alicates de fontanero ajustables
CN 水泵钳

250 mm CrV 1000 V



HALF
DOUBLE
BLISTER

YATO	L (mm)	
YT-21161	250	6/24

1000V
 VDE CERTIFICATE
 EN 60900:2012

GB Insulated flat nose pliers
D Sicherheitsklammer mit Haken
PL Szczypce płaskie izolowane
RUS Клещи для замены предохранителей
CZ Izolované kleště s plochými čelistmi
H Rugós szorító
RO Patent izolat
F Pince plate isolée
I Pinze plate plastica isolati
E Alicates punta plana aislantes
CN 绝缘平嘴钳

200 mm CrV 1000 V



POLYBAG



YATO	L (mm)	
YT-21191	200	6/48

1000V
 VDE CERTIFICATE
 EN 60900:2012

GB Diagonal side cutting pliers
D Seitenschneider
PL Szczypce tnące boczne
RUS Бокорезы
CZ Řezací kleště boční
H Oldal csípőfogó

RO Olește tăietor
F Pince à coupe latérale
I Pinze taglianti laterali
E Alicates corte lateral
CN 斜嘴钳

125 mm
CrV 60
HRC CUTTER 56-62
HRC BODY 43-48
FOR PLASTIC
max. ∅ 3 mm



SLIDING CARD

YATO L (mm) 125 6/120

GB Diagonal side cutting pliers
D Seitenschneider
PL Szczypce tnące boczne
RUS Бокорезы
CZ Řezací kleště boční
H Oldal csípőfogó

RO Olește tăietor
F Pince à coupe latérale
I Pinze taglianti laterali
E Alicates corte lateral
CN 斜嘴钳

150 mm
CrV 60
HRC CUTTER 56-62
HRC BODY 43-48
FOR PLASTIC
max. ∅ 5 mm



SLIDING CARD

YATO L (mm) 150 6/120

GB Diagonal side cutting pliers
D Seitenschneider
PL Szczypce tnące boczne
RUS Бокорезы
CZ Řezací kleště boční
H Oldal csípőfogó

RO Olește tăietor
F Pince à coupe latérale
I Pinze taglianti laterali
E Alicates corte lateral
CN 斜嘴钳

180 mm
CrV 60
HRC CUTTER 56-62
HRC BODY 43-48
FOR PLASTIC
max. ∅ 6 mm



SLIDING CARD

YATO L (mm) 180 6/60

GB Diagonal side cutting pliers
D Seitenschneider
PL Szczypce tnące boczne
RUS Бокорезы
CZ Řezací kleště boční
H Oldal csípőfogó

RO Olește tăietor
F Pince à coupe latérale
I Pinze taglianti laterali
E Alicates corte lateral
CN 斜嘴钳

100 mm
CrV 60
HRC CUTTER 56-62
HRC BODY 43-48
FOR CABLE CUTTING
STEEL max. ∅ 1.0 mm
COPPER max. ∅ 1.8 mm



SLIDING CARD

YATO L (mm) 100 6/120

GB Diagonal side cutting pliers
D Seitenschneider
PL Szczypce tnące boczne
RUS Бокорезы
CZ Řezací kleště boční
H Oldal csípőfogó

RO Olește tăietor
F Pince à coupe latérale
I Pinze taglianti laterali
E Alicates corte lateral
CN 斜嘴钳

125 mm
CrV 60
HRC CUTTER 56-62
HRC BODY 43-48
FOR CABLE CUTTING
STEEL max. ∅ 1.2 mm
COPPER max. ∅ 2.0 mm



SLIDING CARD

YATO L (mm) 125 6/120

GB Long nose pliers
D Radiozange
PL Szczypce wydłużone proste
RUS Тонкогубцы прямые
CZ Prodloužené kleště rovné
H Rádiófogó, egyenes

RO Clește cu vârf ascuțit
F Pince prolongée
I Pinze lunghe diritte
E Alicates de punta
CN 尖嘴钳

150 mm
CrV 60
HRC CUTTER 56-62
HRC BODY 43-48
STEEL max. ∅ 1.5 mm
COPPER max. ∅ 2.6 mm



SLIDING CARD

YATO L (mm) 150 6/120

GB Carpenter's pliers
D Kneifzange
PL Obcegi
RUS Клещи строительные

CZ Kleště
H Harapófógó
RO Cleste cuie
F Tenailles

I Tenaglie
E Tenazas
CN 胡桃钳

160 mm 180 mm 200 mm DIN 5748 NICKEL IRON FINISH



HALF DOUBLE BLISTER



YATO	L (mm)	Box
YT-2046	160	6/60
YT-2047	180	6/60
YT-2048	200	6/60

GB Tower pincers
D Beisszange
PL Obcegi tynkarskie
RUS Клещи штукатурные

CZ Kleště štipací čelní
H Rabitzfógó
RO Cleste pt. cuie
F Tenaille russe

I Tenaglie tronchesi
E Tenazas de enlucido
CN 扎线钳

200 mm 250 mm 275 mm DIN 5748 NICKEL IRON FINISH



HALF DOUBLE BLISTER



YATO	L (mm)	Box
YT-2058	200	6/60
YT-2060	250	6/36
YT-2061	275	6/36

GB Tower pincers
D Beisszange
PL Obcegi tynkarskie
RUS Клещи штукатурные

CZ Kleště štipací čelní
H Rabitzfógó
RO Cleste pt. cuie
F Tenaille russe

I Tenaglie tronchesi
E Tenazas de enlucido
CN 扎线钳

250 mm HRC 44-50 BODY HRC 58-62 CUTTER CrV 55 DIN 5748



HALF DOUBLE BLISTER



YATO	L (mm)	Box
YT-1949	250	6/36

GB Heavy duty side cutting pliers
D Seitenschneider, Schwer Typ
PL Szczypce tnące boczne
RUS Бокорезы усиленные
CZ Řezací kleště boční

H Oldal csípófógó
RO Oleşte tăietor
F Pince à coupe latérale
I Pinze taglianti laterali

E Alicates de corte lateral tipo pesado
CN 重型斜口钳

180 mm DIN 5749 NICKEL IRON FINISH



HALF DOUBLE BLISTER



YATO	L (mm)	Box
YT-2039	180	6/60

GB Carpenter's pliers
D Kneifzange
PL Obcegi
RUS Клещи строительные

CZ Kleště
H Harapófógó
RO Cleste cuie
F Tenailles

I Tenaglie
E Tenazas
CN 胡桃钳

150 mm 175 mm 200 mm CrV 50 HRC 55-60



SLIDING CARD



YATO	L (mm)	cold rolled steel (mm)		Box
		stal walcowana na zimno (mm)	HEAD GLOWIECA	
YT-2050	150	1.5	6/60	
YT-2051	175	1.8	6/60	
YT-2052	200	2.0	6/48	

GB Tower pincers
D Beisszange
PL Obcegi tynkarskie
RUS Клещи штукатурные

CZ Kleště štipací čelní
H Rabitzfógó
RO Cleste pt. cuie
F Tenaille russe

I Tenaglie tronchesi
E Tenazas de enlucido
CN 扎线钳

225 mm 250 mm 275 mm CrV 50 HRC 55-62



SLIDING CARD



YATO	L (mm)	cold rolled steel (mm)		Box
		stal walcowana na zimno (mm)	HEAD GLOWIECA	
YT-2055	225	1.8	6/60	
YT-2056	250	2.0	6/48	
YT-2057	275	2.2	6/24	

GB End cutting pliers
D Vornschneider
PL Szczypce tnące czolowe

RUS Кусачки торцевые
CZ Kleště štipací čelní
H Homlokcsípó fogó

RO Cleste retezat
F Coupe devant
I Pinza a taglio laterale

E Cortacables frontales
CN 顶切钳

150 mm 175 mm 200 mm CrV 50 HRC 55-60



SLIDING CARD











YATO	L (mm)	cold rolled steel (mm)		Box
		stal walcowana na zimno (mm)	HEAD GLOWIECA	
YT-2063	175	1.5	6/48	
YT-2064	200	1.8	6/48	



- GB** Circlip pliers
D Seegeringgzange
PL Szczypce Segera
RUS Съёмник стопорных колец
CZ Kleště Segera
H Segerfogó belső
RO Clește Seger
- F** Pince pour anneau de retenue seeger
I Pinze Seger
E Alicates Seger
CN 5件套卡簧钳

5 PCS **160** mm \varnothing mm **10-50**

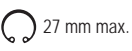

		23 mm max.		20 mm max.
		28 mm max.		23 mm max.
		30 mm max.		27 mm max.





YATO 	L (mm)	
YT-2130	160	20/60



- GB** Circlip pliers
D Seegeringgzange
PL Szczypce Segera
RUS Съёмник стопорных колец
CZ Kleště Segera
H Segerfogó belső
- RO** Clește Seger
F Pince pour anneau de retenue seeger
I Pinze Seger
E Alicates Seger
CN 直嘴轴用挡圈钳





180 mm **HRC 42-48** **CrV 50**





YATO 	L (mm)	
YT-2136	180	6/24

YATO 	L (mm)	
YT-2138	180	6/24



YATO 	L (mm)	
YT-2137	180	6/24

YATO 	L (mm)	
YT-2139	180	6/24

GB Circlip pliers
D Seegeringgzange
PL Szczypce Segera
RUS Съёмник стопорных колец
CZ Kleště Segera
H Segerfogó belső
RO Clește Seger
F Pince pour anneau de retenue seeger
I Pinze Seger
E Alicates Seger
CN 直嘴轴用挡圈钳

SLIDING CARD



150 mm
200 mm
CrV
NICKEL IRON FINISH



YATO	L (mm)	
YT-2140	150	6/120
YT-2144	200	6/60



YATO	L (mm)	
YT-2141	150	6/120
YT-2145	200	6/60



YATO	L (mm)	
YT-2142	150	6/60
YT-2146	200	6/60



YATO	L (mm)	
YT-2143	150	6/120
YT-2147	200	6/60

GB Circlip pliers
D Seegeringgzange
PL Szczypce Segera
RUS Съёмник стопорных колец
CZ Kleště Segera
H Segerfogó belső
RO Clește Seger
F Pince pour anneau de retenue seeger
I Pinze Seger
E Alicates Seger
CN 直嘴轴用挡圈钳

SLIDING CARD



225 mm
325 mm
NICKEL FINISH
CrV



YATO	L (mm)	
YT-1988	225	6/60
YT-1992	325	6/48



YATO	L (mm)	
YT-1989	225	6/60
YT-1993	325	6/48



YATO	L (mm)	
YT-1990	225	6/60
YT-1994	325	6/48



YATO	L (mm)	
YT-1991	225	6/60
YT-1995	325	6/48

- GB** Lock grip pliers
D Gripzange
PL Szczypce Morse'a
RUS Зажим ручной
CZ Kleště Morse'a
H Morse fogó

- RO** Clește Morse
F Pincés de serrage Morse
I Pinze Morse
E Alicates Morse
CN 圆口大力钳

HALF
DOUBLE
BLISTER



CrV



140
mm
240
mm
180
mm
WR
TYPE



165
mm
220
mm
CD
TYPE

YATO	L (mm)	
YT-2151	140	6/48
YT-2152	180	6/36
YT-2153	240	6/36

YATO	L (mm)	
YT-2155	165	6/48
YT-2156	220	6/36

- GB** Locking pliers
D Klemmzange
PL Szczypce zaciskowe
RUS Клещи давяльные
CZ Kleště samosvorné
H Patentfogó
RO Clește de strângere

- F** Pincés de serrage Morse
I Pinze Morse
E Pinzas de tornillo
(de apriete)
CN 圆口大力钳

HALF
DOUBLE
BLISTER



CrMo

6



125
mm

YATO	L (mm)	
YT-2449	125	6/24



250
mm

YATO	L (mm)	
YT-2453	250	6/24



180
mm

YATO	L (mm)	
YT-2450	180	6/24



150
mm

YATO	L (mm)	
YT-2459	150	6/24



250
mm

YATO	L (mm)	
YT-2451	250	6/24



225
mm

YATO	L (mm)	
YT-2460	225	6/24



180
mm

YATO	L (mm)	
YT-2452	180	6/24

- GB** Locking pliers
D Klemmzange
PL Szczypce zaciskowe
RUS Клещи давяльные
CZ Kleště samosvorné

- H** Patentfogó
RO Clește de strângere
F Pince de serrage courte
avec blocage
I Pinze di bloccaggio
E Pinzas
de tornillo (de apriete)
CN 大力钳

HALF
DOUBLE
BLISTER



250
mm

0-42
mm

CrMo



YATO	L (mm)	
YT-2473	250	6/24



YATO	L (mm)	
YT-2476	250	6/24

- GB** Sliding arm welding locking pliers
- D** Parallel-gripszange
- PL** Szybkonastawne szczypce spawalnicze
- RUS** Образная струбцина с захватом
- CZ** Paralelné samosvorné kleště
- H** Szorítórúdas önzáró fogó
- RO** Clește de mana cu prindere tip menghina
- F** Pince-étou - serre-joint coulissant
- I** Scorrevole pinze di bloccaggio di saldatura braccio
- E** Pinzas de presión tipo sargento
- CN** C型滑杆大力钳

260 mm **0-150 mm**
QUICK-ADJUSTMENT
SZYBKONASTAWNY



HALF DOUBLE BLISTER

YATO	L (mm)	
YT-21570	260	2/16

- GB** Welding locking pliers
- D** Klemmzange zum Schweißen
- PL** Szczypce zaciskowe spawalnicze
- RUS** Клещи давяльные сварочные
- CZ** Kleště samosvorné svářečské
- H** Hegesztő fogó
- RO** Clește de strângere pt. sudură
- F** Pince de serrage pour soudeur
- I** Pinze di bloccaggio per saldatura
- E** Pinzas de tornillo (de apriete) para soldar
- CN** 焊接用大力钳



225 mm
TYPE U



YATO	L (mm)	
YT-2461	225	6/24

- GB** Flat locking pliers
- D** Klemmzange mit breiten Backen
- PL** Szczypce zaciskowe o szerokich szczękach
- RUS** Клещи давяльные с широкими губками
- CZ** Kleště samosvorné se širokými čelistmi
- H** Lapos fogó
- RO** Clește de strângere plat / patent
- F** Pince de serrage large
- I** Pinze con ganasce piane e palette
- E** Pinzas de tornillo (de apriete) con mordazas anchas
- CN** 铁皮大力钳



200 mm
0-12.7 mm
78 mm



YATO	L (mm)	
YT-2463	200	6/24

- GB** C-type welding locking pliers
- D** Klemm- und Klammerzange vom Typ „C“
- PL** Szczypce zaciskowe klamrowe typu „C“
- RUS** Клещи давяльные типа „С“
- CZ** Kleště samosvorné upínací typu „C“
- H** „C“ fogó
- RO** Clește de strângere cu clemă tip „C“
- F** Pince de serrage type „C“
- I** Pinze di bloccaggio tipo „C“
- E** Pinzas de tornillo (de apriete) de grapa tipo „C“
- CN** C型大力钳

HALF DOUBLE BLISTER



280 mm
0-100 mm
TYPE C



MOVABLE JAWS
 RUCHOME SZCZĘKI



YATO	L (mm)	
YT-2466	280	6/24

YATO	L (mm)	
YT-2468	280	6/24

- GB** Chain locking pliers
- D** Klemmzange mit Kette
- PL** Szczypce zaciskowe z łańcuchem
- RUS** Клещи давяльные с цепью
- CZ** Kleště samosvorné s řetězem
- H** Láncos csőfogó
- RO** Clește de strângere cu lanț
- F** Pince de serrage avec une chaîne
- I** Pinze di bloccaggio con la catena
- E** Pinzas de tornillo (de apriete) con cadena
- CN** 链条大力钳

HALF DOUBLE BLISTER



500 mm
40 Mn



YATO		
YT-2469		6/24

- GB** Self-locking multi grip pliers
D Grip-Festhaltezange
PL Szczypce blacharskie
RUS Зажим ручной сварочный для закрепления лент и профилей
CZ Kleště klempířské samodržící
H Őnzáró rögzítőfogó

- RO** Cleste autoblocant pt. tinichigerie
F Pince pour tôle
I Pinze per lamiera
E Pinzas de chapa
CN 多功能大力钳



YATO	L (mm)	
YT-2160	200	12/24



YATO	L (mm)	
YT-2161	230	12/24

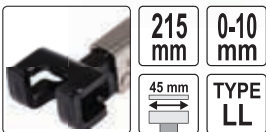

YATO	L (mm)	
YT-2162	215	12/36

- GB** Profile connection pliers
D Zange zum Verbinden der Profile
PL Szczypce do łączenia profili
RUS Щипцы для соединения профилей
CZ Kleště ke spojování profilů
H Profilgyesítő fogó

- RO** Cleste pt. îmbinarea profilelor
F Pince pour servir les profiles
I Pinze per la unione profili
E Pinzas para conectar perfiles
CN 龙骨钳

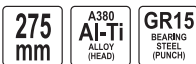

YATO	L (mm)	
YT-5130	275	6/24



YATO	L (mm)	
YT-5131	345	6/24

- GB** Profile connection pliers
D Zange zum Verbinden der Profile
PL Szczypce do łączenia profili
RUS Щипцы для соединения профилей
CZ Kleště ke spojování profilů
H Profilgyesítő fogó
RO Cleste pt. îmbinarea profilelor

- F** Pince pour servir les profiles
I Pinze per la unione profili
E Pinzas para conectar perfiles
CN 新款长柄龙骨钳



YATO	L (mm)	
YT-51311	280	6/24

- GB** Punch pliers
D Blech Lochzange
PL Szczypce do dziurkowania blach
RUS Прокататель круглых отверстий
CZ Děrovací kleště
H Fogó peremező lyukasztó

- RO** Cleste pt. perforat
F Trou pincés feuilles
I Pinza per forare lamiera
E Punzonadora una mano perfiles
CN CS打孔钳



YATO	L (mm)	
YT-51320	240	5/30

- GB** Profile forming pliers
D Zange zur Formgebung der Profile
PL Szczypce do kształtowania profili
RUS Щипцы для формировки профилей
CZ Kleště k tvarování profilů

- H** Profilformázó fogó
RO Cleste pt. modelarea profilelor
F Pince pour former les profiles
I Pinze per la formazione di profili
E Pinzas para formar perfiles
CN 龙骨钳



YATO	L (mm)	
YT-5140	210	2/12



YATO	L (mm)	
YT-5141	210	2/12



YATO	L (mm)	
YT-5142	210	2/12

GB Water pump pliers
D Wasserpumpenzange
PL Szczypce nastawne
RUS Клещи переставные
CZ Keleště siko
H Vízpumpaľagó

RO Cleste papagal
F Pince réglable
I Pinze regolabili
E Alicates de fontanero ajustables
CN 水泵钳

250 mm
300 mm
CrV
WORKING RANGE ADJUSTMENT REGULACJA ZAKRESU PRACY
STRENGTHENED JAWS WZMOCNIENNA KONSTRUKCJA



YATO	L (mm)	
YT-2090	250	6/36
YT-2091	300	6/36

GB Water pump pliers
D Wasserpumpenzange
PL Szczypce nastawne
RUS Клещи переставные
CZ Keleště siko
H Vízpumpaľagó

RO Cleste papagal
F Pince réglable
I Pinze regolabili
E Alicates de fontanero ajustables
CN 水泵钳

HALF DOUBLE BLISTER
250 mm
NICKEL IRON FINISH



YATO	L (mm)	
YT-2069	250	6/36

6

GB Water pump pliers
D Wasserpumpenzange
PL Szczypce nastawne
RUS Клещи переставные
CZ Keleště siko
H Vízpumpaľagó

RO Cleste papagal
F Pince réglable
I Pinze regolabili
E Alicates de fontanero ajustables
CN 水泵钳

250 mm
JAW WIDTH SZEROKOSC SZCZEK 6 mm
CrV
WORKING RANGE ADJUSTMENT REGULACJA ZAKRESU PRACY
STRENGTHENED JAWS WZMOCNIENNA KONSTRUKCJA



YATO	L (mm)	
YT-20911	250	10/50

GB Water pump pliers
D Wasserpumpenzange
PL Szczypce nastawne
RUS Клещи переставные
CZ Keleště siko
H Vízpumpaľagó

RO Cleste papagal
F Pince réglable
I Pinze regolabili
E Alicates de fontanero ajustables
CN 水泵钳

HALF DOUBLE BLISTER
250 mm
NICKEL IRON FINISH



YATO	L (mm)	
YT-2070	250	6/24

GB Pipe wrench
D Rohrschlüssel
PL Klucz do rur
RUS Ключ трубный

CZ Klíč součásti na trubky
H Csökulcs
RO Cheie reglabila pt. tevi

F Clé aux tubes
I Chiave per tubi
E Llave para tubos
CN 铝合金管钳

CrMo

HRC 55-60

AL HANDLE UCHWYT



YATO	size / rozmiar	max. pipe diameter / max. średnica rury	
YT-2482	14" (350 mm)	2" (50 mm)	6/12
YT-2483	18" (450 mm)	2.5" (63 mm)	2/10
YT-2484	24" (600 mm)	3" (75 mm)	2/6
YT-2485	36" (900 mm)	5" (125 mm)	3

GB Pipe wrench
D Rohrschlüssel
PL Klucz do rur
RUS Ключ трубный

CZ Klíč součásti na trubky
H Csökulcs
RO Cheie reglabila pt. tevi

F Clé aux tubes
I Chiave per tubi
E Llave para tubos
CN 铝合金管钳

CrMo

HRC 55-60



YATO	size / rozmiar	max. pipe diameter / max. średnica rury	
YT-2488	10" (250 mm)	1" (25 mm)	6/18
YT-2489	12" (300 mm)	1.5" (38 mm)	6/12
YT-2490	14" (350 mm)	2" (50 mm)	2/10
YT-2491	18" (450 mm)	2.5" (63 mm)	3/6
YT-2492	24" (600 mm)	3" (75 mm)	2/4
YT-2493	36" (900 mm)	5" (125 mm)	1
YT-2494	48" (1200 mm)	6" (150 mm)	1

GB Pipe wrench
D Rohrschlüssel
PL Klucz do rur
RUS Ключ трубный

CZ Klíč součásti na trubky
H Csökulcs
RO Cheie reglabila pt. tevi

F Clé aux tubes
I Chiave per tubi
E Llave para tubos
CN 铝合金管钳

HRC 55-60

AL HANDLE UCHWYT



YATO	size / rozmiar	max. pipe diameter / max. średnica rury	
YT-2222	12" (300 mm)	1" (25 mm)	6/24
YT-2223	14" (350 mm)	1.5" (38 mm)	4/16
YT-2224	18" (450 mm)	2" (50 mm)	3/12
YT-2225	24" (600 mm)	2.5" (63 mm)	3/6

GB Pipe wrench
D Rohrschlüssel
PL Klucz do rur
RUS Ключ трубный

CZ Klíč součásti na trubky
H Csökulcs
RO Cheie reglabila pt. tevi

F Clé aux tubes
I Chiave per tubi
E Llave para tubos
CN 铝合金管钳

HRC 55-60

OFFSET TYPE ODGIĘTA GŁOWICA



YATO	size / rozmiar	max. pipe diameter / max. średnica rury	
YT-2201	10" (250 mm)	1" (25 mm)	6/36
YT-2203	14" (350 mm)	1.5" (38 mm)	4/16
YT-2204	18" (450 mm)	2" (50 mm)	3/12
YT-2205	24" (600 mm)	2.5" (63 mm)	3/6
YT-2206	36" (900 mm)	4" (100 mm)	2/4

- GB** Auto-adjustable pipe wrench
D Rollgabelschlüssel
PL Szybkonastawny klucz do rur
RUS Ключ разводной
CZ Nastavitelný klíč
H Állítható svédkulcs
- RO** Cheie reglabilă
F Clé à molette
I Chiave autoregolabile per tubi
E Llave ajustable
CN 可调式管钳

16-38 mm
5/8"-1 1/2"

300 mm

SELF-ADJUSTING
SAMO-NASTAWNY

QUICK RELEASE
SZYBKIE OTWIERANIE

HRC 46-52

HARDENED JAWS
HARTOWANE SZCZĘKI

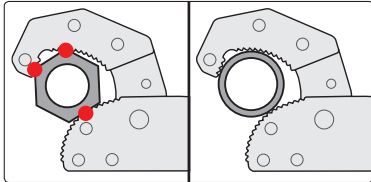

HALF DOUBLE BLISTER

YATO	L (mm)	
YT-22005	300	6/24

- GB** Strap wrench
D Bandschlüssel
PL Klucz taśmowy do rur
RUS Строчковый ключ
CZ Klíč s popruhem
H Csőfogó
- RO** Cheie cu chinga
F Clé a sangle sanitaire
I Chiave a nastro per tubi
E Llave de correa
CN 皮带管钳

300 mm
12"

200 mm
8"

STRAP SIZE
WYMIAR PASMA
825 x 28 mm

NYLON

AI

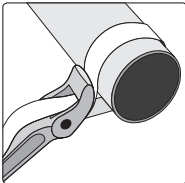

- for:
- chromed pipes
 - PVC pipes
 - oil filters
- do:
- rur chromowanych
 - rur PCV
 - filtrów oleju



SLIDING CARD

YATO	L (mm)	max. pipe diameter / max. średnica rury	
YT-22255	300	8" (200 mm)	5/50

- GB** Chain pipe wrench
D Kettenrohrzange
PL Klucz łańcuchowy do rur
- RUS** Ключ цепной для труб
CZ Klíč řetězový na trubky
H Láncos csőfogó
- RO** Cheie reglabila pt. tevi cu lant
F Clé à chaîne
- I** Chiave a catena per tubi
E Llave de cadena
CN 链条管子钳

SLIDING CARD

4"

100 mm

300 mm

INDUCTION HARDENED TEETH
STAL NIEROZŻEWNA

ANTI MAGNETIC ANTYMAGNETYCZNA

ANTI ACID KWASO-ODPORNA



- GB** Tweezer
D Pinzette
PL Pęseta
RUS Пинцет
- CZ** Pinzeta
H Csipesz
RO Pensetă
F Pince
- I** Pinza
E Pinzas
CN 镊子

SLIDING CARD

140 mm

HRC 30

302 STAINLESS STEEL
STAL NIEROZŻEWNA

ANTI MAGNETIC ANTYMAGNETYCZNA

ANTI ACID KWASO-ODPORNA



YATO	L (mm)	
YT-6903	140	20/480



YATO	L (mm)	
YT-6907	115	20/240



YATO	L (mm)	
YT-6916	140	20/240

- GB** Pipe wrench - german type
D Rohrschlüssel - deutsch type
PL Klucz do rur - typ niemiecki
RUS Трубный ключ - немецкий тип
CZ Nastavitelný klíč na trubky - němčina typ
- H** Állítható csőkulcs - német típusú
RO Cheie reglabilă pt. tevi - tip german
F Clé serre-tube type allemand
I Chiave per tubi - tipo tedesco
E Llave para tubos tipo alemán
CN 德式管子钳

HRC 47-53

HARDENED JAWS
HARTOWANE SZCZĘKI



COLOR BOX

YATO	L (mm)	max. opening capacity / max. zakres rozwarcia szczęk (mm)	max. pipe diameter / max. średnica rury (mm)	
YT-22000	7" (175 mm)	45	20	6/60
YT-22001	9" (225 mm)	60	30	6/36
YT-22002	10.5" (275 mm)	70	35	6/24

- GB** Strap for pipe wrench
D Gurt für Bandschlüssel
PL Taśma zapasowa do klucza do rur
RUS Ремень для ремешковых ключи
CZ Popruh pro klíče olejových filtrů
- H** Szíjas az szíjas csőfogó
RO Chinga la chei cu chingă
F Courroie pour clés a courroie
I Nastro di ricambio per chiave per tubi
E Correa a llaves de correa
CN 皮带管钳配件

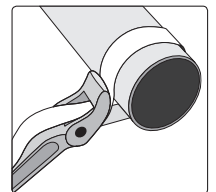

for / dla: YT-22255

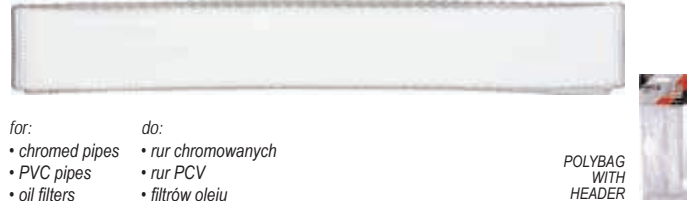

- for:
- chromed pipes
 - PVC pipes
 - oil filters
- do:
- rur chromowanych
 - rur PCV
 - filtrów oleju





















POLYBAG WITH HEADER

YATO	
YT-22256	50

7

Electrician tools Narzędzia dla elektryków



Insulated screwdrivers Wkrętaki izolowane		110	Insulated hex keys Klucze imbusowe izolowane		114
Insulated slotted screwdrivers Wkrętaki izolowane płaskie		110	Insulated clamps Ściski izolowane		114
Insulated phillips screwdrivers Wkrętaki izolowane krzyżakowe		110	Crimping pliers & sets Szcypce do zaciskania konektorów i zestawy		114-116
Insulated Pozidrive screwdrivers Wkrętaki izolowane „Pozidrive”		110	Hydraulic pliers Ręczne praski hydrauliczne		117
Insulated screwdriver sets Komplety wkrętek izolowanych		110	Wire strippers Ściągacze izolacji		117-119
Insulated pliers Szcypce izolowane		111	Electrical cutters Obcinaki elektryczne		119-120
Combination pliers Szcypce uniwersalne		111	Cable cutters Nożyce do kabli		120-121
Side cutting pliers Szcypce tnące, boczne		111	Electric meters & voltage testers Mierniki elektryczne i próbniki napięcia		122
Long nose pliers Szcypce wydłużone, proste		111	Multimeters Mierniki		123
Wire stripping pliers Szcypce do ściągania izolacji		111	Glue guns Pistolety do klejenia		123
Water pump pliers Szcypce nastawne		111	Soldering tools & accessories Lutownice i akcesoria		124
Insulated flat nose pliers Klucze płaskie izolowane		111	Tweezers Pęsety		125
Insulated ring & open end wrenches Klucze oczkowe i płaskie izolowane		112	Insulated hexagonal sockets 3/8” Klucze nasadowe sześciokątne izolowane, krótkie 3/8”		113
Insulated ring wrenches Klucze oczkowe izolowane		112	Insulated extension bars 3/8” Przedłużki izolowane 3/8”		113
Insulated open end wrenches Klucze płaskie izolowane		112	Insulated ratchet handles 3/8” Grzechotki izolowane 3/8”		113
Insulated T-handle wrenches Rękojeści typu „T” z zabierakiem izolowane		112	Insulated hexagonal sockets 1/2” Klucze nasadowe sześciokątne izolowane, krótkie 1/2”		113
Insulated adjustable wrenches Klucze nastawne izolowane		112	Insulated extension bars 1/2” Przedłużki izolowane 1/2”		113
Insulated sockets & accessories Klucze nasadowe izolowane i akcesoria		113	Insulated ratchet handles 1/2” Grzechotki izolowane 1/2”		113
Insulated bit sockets 3/8”, 1/2” Klucze trzpieniowe izolowane 3/8”, 1/2”		114	Tool sets Zestawy narzędziowe		126
			Workshop standardized parts Normalia motoryzacyjne		126

- GB** Insulated screwdriver
D Isolierte Schraubendreher
PL Wkrętek izolowany
RUS Изолированная отвёртка
CZ Izolovaný šroubovák
H Szigetelt csavarhúzó

- RO** Șurubelniță izolată
F Tournevis isolé
I Cacciavite isolato
E Destornillador aislado
CN 绝缘螺丝批



- application: industry
- VDE certificate
- przeznaczenie: przemysł
- certyfikat VDE

1000 V

S2

HRC 56-60



YATO	⊖	L (mm)	
YT-2815	3.0	75	12/120
YT-2816	4.0	75	12/120
YT-2817	4.0	100	12/120
YT-2818	5.5	125	12/120
YT-2819	6.5	150	12/120
YT-2820	8.0	175	12/120



YATO	⊕	L (mm)	
YT-2821	PH0	60	12/120
YT-2822	PH1	80	12/120
YT-2823	PH2	100	12/120
YT-2824	PH3	150	12/120



YATO	⊕	L (mm)	
YT-2825	PZ1	80	12/120
YT-2826	PZ2	100	12/120

7

- GB** Insulated screwdriver set
D Isolierte Schraubendrehersatz
PL Komplet wkrętek izolowanych
RUS Изолированная отвёртка - набор

- CZ** Izolované šroubováky
H Szigetelt csavarhúzó
RO Șurubelniță izolată
F Set de tournevis isolés

- I** Set di cacciavite isolato
E Juego de destornilladores aislado
CN 绝缘螺丝批组套

- application: industry
- VDE certificate
- przeznaczenie: przemysł
- certyfikat VDE

DOUBLE BLISTER



1000 V

S2

HRC 56-60



5 PCS



7 PCS



YATO	⊖	⊕	L (mm)	
YT-2827	3.0		75	20/40
	4.0		100	
	5.5		125	
		PH1	80	
		PH2	100	

YATO	⊖	⊕	⊕	L (mm)	
YT-2828	3.0			75	20/40
	4.0			100	
	5.5			125	
		PH1		80	
		PH2		100	
			PZ1	80	
			PZ2	100	

- GB** Insulated changeable screwdriver set
D Schraubendreher Satz isoliert
PL Zestaw wkrętek z wymiennymi końcówkami izolowanymi

- RUS** Набор изолированных отверток
CZ Sada izolovaného nářadí
H Csavarhúzó kétvégű szárral
RO Set surubelnita cu biti, izolate

- F** Jeu d'outils isolés
I Set di cacciavite isolato
E Juego de destornilladores aislado
CN 绝缘螺丝批组套

1000V
 VDE CERTIFICATE
 EN 60900:2012

NYLON CASE & POLYBAG



1000 V

HRC 54-61

S2



⊖ 2.0, 2.5, 3.0, 3.5, 4.0, 5.5, 6.5 (L=100 mm); S2;
 ⊕ PH0, PH1, PH2 (L=100 mm); S2;
 ⊕ 4x150 mm; 250V

⊖ 2.0, 2.5, 3.0, 3.5, 4.0, 5.5, 6.5 (L=100 mm); S2;
 ⊕ PH0, PH1, PH2 (L=100 mm); S2;
 ⊕ PZ0, PZ1, PZ2 (L=100 mm); S2;
 ⊕ T6, T8, T9, T10, T15, T20, T25, T27, T30 (L=100 mm); S2;
 ⊕ 2, 3, 4, 5, 6 (L=100 mm); S2;
 ⊕ R1, R2 (L=100 mm); S2;
 ⊕ 1, 2, 3, 4 (L=100 mm); S2;
 ⊕ 4, 6, 8, 10 (L=100 mm); S2;
 ⊕ 4, 6, 8, 10 (L=100 mm); S2;
 ⊕ M4, M5, M6 (L=100 mm); S2;
 ⊕ 4x150 mm; 250V

12 PCS



YATO	
YT-28290	24

50 PCS



YATO	
YT-28293	10

GB Combination pliers
D Kombinationszange
PL Szczypce uniwersalne
RUS Плоскогубцы универсальные
CZ Kleště kombinované
H Kombináltfogó
RO Patent universal
F Pince universelle
I Pinze universali
E Alicates universales
CN 钢丝钳

160 mm 180 mm 200 mm CrV 1000 V



HALF DOUBLE BLISTER

YATO	L (mm)	
YT-21151	160	6/36
YT-21152	180	6/36
YT-21153	200	6/36

1000V
VDE CERTIFICATE
EN 60900:2012

GB Diagonal side cutting pliers
D Seitenschneider
PL Szczypce tnące boczne
RUS Бокорезы
CZ Rezací kleště boční
H Oldal csípőfogó
RO Olește tăietor
F Pince à coupe latérale
I Pinze taglianti laterali
E Alicates corte lateral
CN 斜嘴钳

160 mm 180 mm CrV 1000 V



HALF DOUBLE BLISTER

YATO	L (mm)	
YT-21158	160	6/36
YT-21159	180	6/36

1000V
VDE CERTIFICATE
EN 60900:2012

GB Long nose pliers
D Radiozange
PL Szczypce wydłużone proste
RUS Тонкогубцы прямые
CZ Prodloužené kleště rovné
H Rádiófogó, egyenes
RO Clește cu vârf ascuțit
F Pince prolongée
I Pinze lunghe diritte
E Alicates de punta
CN 尖嘴钳

160 mm 200 mm CrV 1000 V



HALF DOUBLE BLISTER

YATO	L (mm)	
YT-21154	160	6/36
YT-21155	200	6/36

1000V
VDE CERTIFICATE
EN 60900:2012

GB Wire stripping pliers
D Abisolierzange
PL Szczypce do ściągania izolacji
RUS Пасатижи для зачистки проводов
CZ Kleště odizolovací na drát
H Blankoló fogó
RO Decablator
F Pince à l'isolation
I Pinze spelafili
E Pinzas pelacables
CN 剥线钳

160 mm CrV 1000 V



HALF DOUBLE BLISTER

YATO	L (mm)	
YT-21160	160	6/36

1000V
VDE CERTIFICATE
EN 60900:2012

GB Water pump pliers
D Wasserpumpenzange
PL Szczypce nastawne
RUS Клещи переставные
CZ Keleště siko
H Vizpumpafogó
RO Clește papagal

F Pince réglable
I Pinze regolabili
E Alicates de fontanero ajustables
CN 水泵钳

250 mm CrV 1000 V



HALF DOUBLE BLISTER

YATO	L (mm)	
YT-21161	250	6/24

1000V
VDE CERTIFICATE
EN 60900:2012

GB Insulated flat nose pliers
D Sicherheitsklammer mit Haken
PL Szczypce płaskie izolowane
RUS Клещи для замены предохранителей
CZ Izolované kleště s plochými čelistmi
H Rugós szorító
RO Patent izolat
F Pince plate isolée
I Pinze plate plastica isolati
E Alicates punta plana aislantes
CN 绝缘平嘴钳

200 mm CrV 1000 V



POLYBAG

YATO	L (mm)	
YT-21191	200	6/48

1000V
VDE CERTIFICATE
EN 60900:2012

GB Insulated ring wrench
D Einringschlüssel vollisoliert
PL Klucz oczkowy odgięty izolowany
RUS Ключ накидной односторонний изолированный

CZ Očkový klíč, izolovaný
H Hajlítótszárú csillagkulcs
RO Cheie inelara izolata
F Clé polygonale coudée isolée

I Chiave poligonale piegato isolato
E Llave de estrella acodada aislante
CN 绝缘梅花扳手



1000V
 VDE CERTIFICATE
 EN 60900:2012

POLYBAG

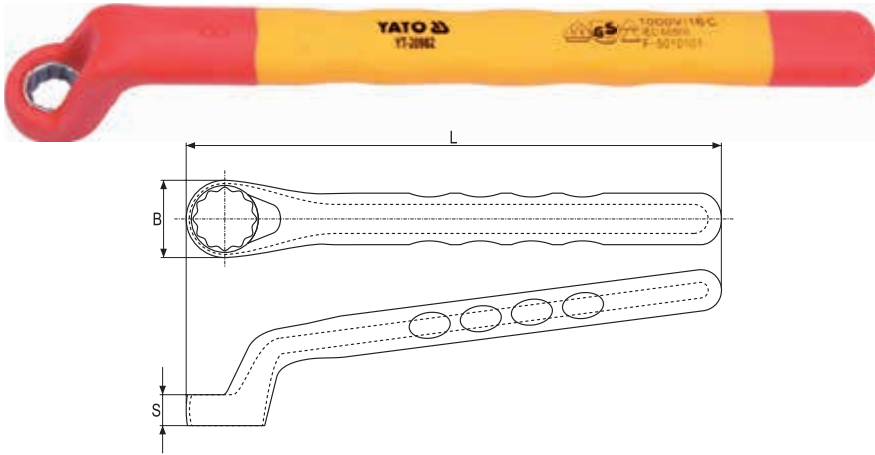

YATO	Ø (mm)	L (mm)	B (mm)	S (mm)	Box
YT-20980	6	150	16.0	5.5	6/126
YT-20981	7	150	18.0	5.7	6/126
YT-20982	8	155	19.0	6.1	6/126
YT-20983	9	155	20.0	7.2	6/126
YT-20984	10	170	21.0	7.3	6/90
YT-20985	11	170	22.5	7.7	6/90
YT-20986	12	190	22.5	8.5	6/90
YT-20987	13	190	26.5	9.0	6/90
YT-20988	14	205	28.0	9.5	6/90
YT-20989	15	205	29.0	9.5	6/90
YT-20990	16	215	31.0	10.2	6/90
YT-20991	17	215	32.0	10.7	6/90
YT-20992	18	230	35.0	11.5	6/90
YT-20993	19	230	36.0	12.0	6/90
YT-20994	21	245	39.0	13.0	6/48
YT-20995	22	245	41.0	12.2	6/48
YT-20996	24	265	44.0	13.0	6/48
YT-20997	27	290	48.0	14.5	4/40
YT-20998	30	310	52.0	15.2	4/40
YT-20999	32	310	55.0	16.5	4/40

GB Insulated open end wrench
D Doppelmaulschlüssel isoliert
PL Klucz plaski izolowany
RUS Ключ рожковой односторонний изолированный

CZ Otvřený klíč, izolovaný
H Vállaskulcs
RO Cheie fixă izolată
F Clé plate isolée

I Chiave piatta isolato
E Llave fija aislante
CN 绝缘开口扳手



1000V
 VDE CERTIFICATE
 EN 60900:2012

POLYBAG

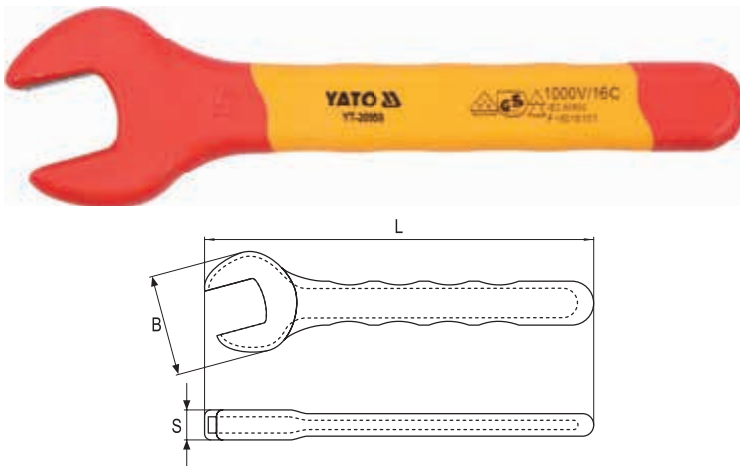

YATO	Ø (mm)	L (mm)	B (mm)	S (mm)	Box
YT-20950	6	90	23	7.0	6/108
YT-20951	7	90	25	7.0	6/108
YT-20952	8	100	27	7.5	6/108
YT-20953	9	100	29	7.5	6/108
YT-20954	10	110	31	8.0	6/108
YT-20955	11	110	34	8.5	6/108
YT-20956	12	130	36	8.5	6/108
YT-20957	13	135	39	10.5	6/108
YT-20958	14	145	40	10.5	6/72
YT-20959	15	150	42	11.5	6/72
YT-20960	16	160	43	11.5	6/72
YT-20961	17	160	47	12.5	6/72
YT-20962	18	175	50	13.0	6/72
YT-20963	19	175	53	14.0	6/72
YT-20964	21	195	55	14.0	6/66
YT-20965	22	195	58	14.0	6/66
YT-20966	24	225	62	16.5	6/66
YT-20967	27	250	69	18.0	4/60
YT-20968	30	290	75	19.0	4/48
YT-20969	32	310	79	20.0	4/48

GB Insulated T-handle wrench
D Steckschlüssel T-griff vollisoliert
PL Rekojęść typu „T” izolowana
RUS Ручка Т-образная изолированная
CZ Klíč nástrčný typ „T”, izolovaný
H „T” típusú dugókulcs

RO Manert tip „T” izolat
F Clé à tube en „T” isolée
I Chiave a bussola tipo „T” isolati
E Llave tubular „T” aislante
CN 绝缘T型扳手

3/8" 10mm | 1/2" 12.5mm | CrV

1000V DE protection symbols

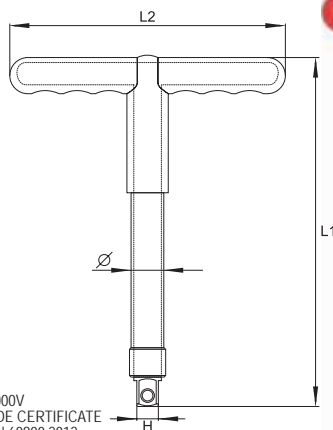

1000V
 VDE CERTIFICATE
 EN 60900:2012

POLYBAG



YATO	Ø H	L1 (mm)	L2 (mm)	Ø (mm)	Box
YT-21095	3/8" (9.5 mm)	207	160	15.6	4/32
YT-21096	1/2" (12.7 mm)	207	160	19.3	4/32

GB Insulated adjustable wrench
D Rollgabelschlüssel isoliert
PL Klucz nastawny izolowany
RUS Ключ разводной изолированный
CZ Izolovaný staviteľný klíč
H Állítható svédkulcs
RO Cheie reglabilă izolată
F Clé à molette isolée
I Isolati chiave regolabile
E Llave ajustable aislante
CN 绝缘活络扳手

200mm 250mm 300mm | CrV 1000V DE protection symbols

CrV 1000V DE protection symbols



1000V
 VDE CERTIFICATE
 EN 60900:2012

POLYBAG



YATO	L (mm)	Box
YT-20940	200	6/48
YT-20941	250	6/36
YT-20942	300	4/24

- GB** Insulated hexagonal socket
D Sechskantenschlüssel vollisoliert
PL Nasadka sześciokątna izolowana
RUS Головка шестигранная короткая изолированная
CZ Šestihranný nástavec, izolovaný
H Hatszögű rátét
RO Cheie tubulară hexagonală izolată
F Douille courte isolée
I Chiave a bussola esagonale isolato
E Boquilla hexagonal corta aislante
CN 绝缘六角套筒

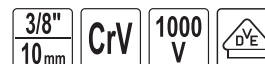
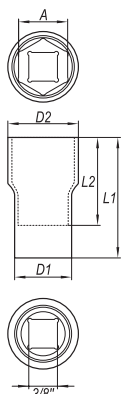

1000V VDE CERTIFICATE EN 60900:2012

YATO	Ø A (mm)	D1 (mm)	D2 (mm)	L1 (mm)	L2 (mm)	
YT-21008	8	18	15.1	45	28	7/126
YT-21010	10	18	18.7	45	28	7/126
YT-21011	11	18	20.0	45	28	7/126
YT-21012	12	18	21.2	45	28	7/126
YT-21013	13	18	22.5	45	28	7/126
YT-21014	14	18	23.7	45	28	7/126
YT-21016	16	18	26.2	45	28	7/126
YT-21017	17	18	27.5	45	28	7/126
YT-21018	18	18	28.7	45	30	5/90
YT-21019	19	18	30.0	47	30	5/90
YT-21021	21	18	32.6	47	30	5/90
YT-21022	22	18	33.7	47	30	5/90



- GB** Insulated extension bar
D Verlängerung vollisoliert
PL Przedłużka izolowana
RUS Удлинитель для воротка
CZ Prodlužovací přípravek, izolovaný
- H** Toldalék
RO Prelungitor izolat
F Rallonge isolée
I Prolunga isolato
E Tubo de prolongación aislante
CN 绝缘接杆

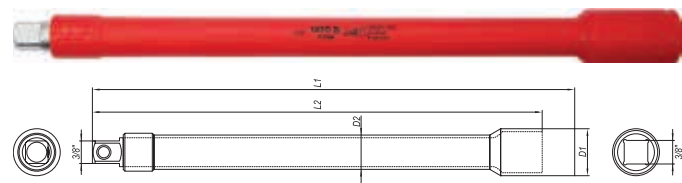
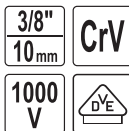
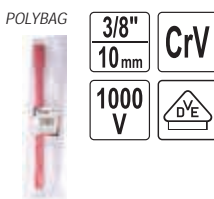

1000V VDE CERTIFICATE EN 60900:2012

YATO	Ø	D1 (mm)	D2 (mm)	L1 (mm)	L2 (mm)	
YT-21055	3/8" (9.5 mm)	23	15.5	125	141	18/72
YT-21056	3/8" (9.5 mm)	23	15.5	250	266	12/48

- GB** Insulated hexagonal socket
D Sechskantenschlüssel vollisoliert
PL Nasadka sześciokątna izolowana
RUS Головка шестигранная короткая изолированная
CZ Šestihranný nástavec, izolovaný
H Hatszögű rátét
RO Cheie tubulară hexagonală izolată
F Douille courte isolée
I Chiave a bussola esagonale isolato
E Boquilla hexagonal corta aislante
CN 绝缘六角套筒

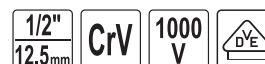
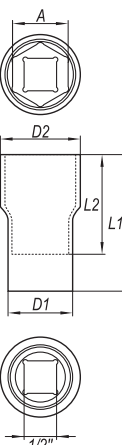

1000V VDE CERTIFICATE EN 60900:2012

YATO	Ø A (mm)	D1 (mm)	D2 (mm)	L1 (mm)	L2 (mm)	
YT-21030	10	27	19.5	55	38	12/144
YT-21031	11	27	20.7	55	38	12/144
YT-21032	12	27	22.0	55	38	12/144
YT-21033	13	27	23.2	55	38	12/144
YT-21034	14	27	24.5	55	38	12/144
YT-21036	16	27	27.0	55	38	12/144
YT-21037	17	27	28.5	55	38	12/144
YT-21038	18	27	29.5	55	38	12/144
YT-21039	19	27	30.7	55	38	12/144
YT-21041	21	27	33.2	55	38	10/110
YT-21042	22	27	34.5	55	38	10/110
YT-21044	24	27	37.0	60	38	10/110
YT-21047	27	27	38.8	60	38	6/66
YT-21050	30	27	42.8	60	38	6/66
YT-21052	32	27	44.8	60	38	6/66

- GB** Insulated extension bar
D Verlängerung vollisoliert
PL Przedłużka izolowana
RUS Удлинитель для воротка
CZ Prodlužovací přípravek, izolovaný
- H** Toldalék
RO Prelungitor izolat
F Rallonge isolée
I Prolunga isolato
E Tubo de prolongación aislante
CN 绝缘接杆

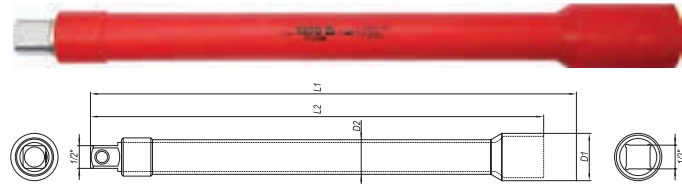
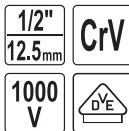
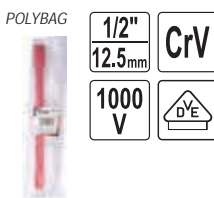

1000V VDE CERTIFICATE EN 60900:2012

YATO	Ø	D1 (mm)	D2 (mm)	L1 (mm)	L2 (mm)	
YT-21057	1/2" (12.7 mm)	27	19.1	125	141	6/72
YT-21058	1/2" (12.7 mm)	27	19.1	250	266	8/32

- GB** Insulated ratchet handle
D Hebelumschaltknarre vollisoliert
PL Grzechotka izolowana
RUS Трещотка диэлектрическая
CZ Řehtačka, izolovaná
H Racsnis hajtókar
- RO** Antrenor cu clichet izolat
F Clé à cliquet isolée
I Cricchetto bussola isolato
E Carraca aislante
CN 绝缘棘轮扳手

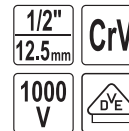

1000V VDE CERTIFICATE EN 60900:2012

YATO	Ø	T	L (mm)	
YT-21072	1/2" (12.7 mm)	36	250	6/36

GB Insulated star bit socket
D Aufsteckschlüssel vollisoliert
PL Klucze trzpieniowe izolowane
RUS Головка торцевая с вставкой hex изолированная
CZ Čerové klíče izolované
H Csapkulcs
RO Chei cu cozi izolat
F Douille tournevis isolée
I Chiave esagonale isolato
E Llaves de mandril aislante
CN 绝缘套筒批
POLYBAG

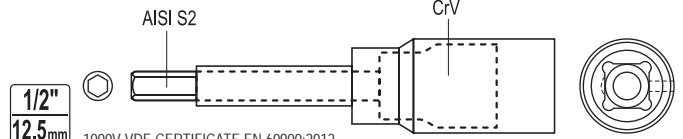
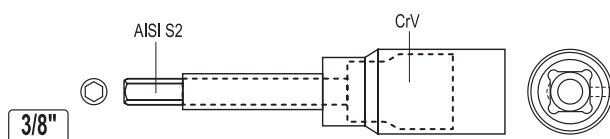

3/8"
10mm

1000V VDE CERTIFICATE EN 60900:2012

1/2"
12.5mm

1000V VDE CERTIFICATE EN 60900:2012

YATO	Ø	Hex	L (mm)	torque / moment obrotowy max. (Nm)	Box
YT-21080	3/8" (9.5 mm)	4	75	16.0	12/144
YT-21081	3/8" (9.5 mm)	5	75	30.0	12/144
YT-21082	3/8" (9.5 mm)	6	75	52.0	12/144
YT-21083	3/8" (9.5 mm)	8	75	120.0	12/144

YATO	Ø	Hex	L (mm)	torque / moment obrotowy max. (Nm)	Box
YT-21085	1/2" (12.7 mm)	4	120	16.0	18/144
YT-21086	1/2" (12.7 mm)	5	120	30.0	18/144
YT-21087	1/2" (12.7 mm)	6	120	52.0	18/144
YT-21088	1/2" (12.7 mm)	8	120	120.0	18/144
YT-21089	1/2" (12.7 mm)	10	120	220.0	18/144

7

GB Insulated hex key
D Steckschlüssel
PL Klucz sześciokątny izolowany
RUS Накладной гаечный ключ угловой
CZ Imbusové klíče izolované
H Imbisz kulcs
RO Imbusuri hexagonale izolate
F Clés allen isolée
I Chiave esagonale isolato
E Punta vaso aislante
CN 绝缘内六角扳手
POLYBAG

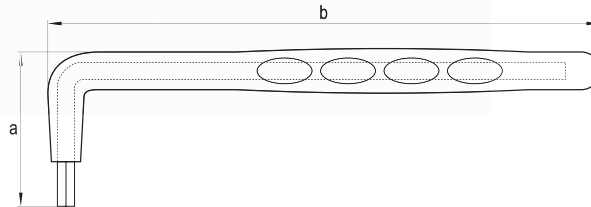
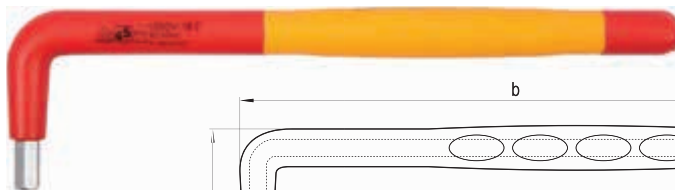

1000V VDE CERTIFICATE EN 60900:2012

YATO	Ø (mm)	a (mm)	b (mm)	Box
YT-21120	3.0	25	130	12/144
YT-21121	4.0	40	140	12/144
YT-21122	5.0	45	160	12/144
YT-21123	6.0	47	180	10/120
YT-21125	8.0	50	200	10/120
YT-21126	10.0	52	235	6/48
YT-21127	12.0	60	260	6/48

GB Insulated spring clamp
D Federklemme vollisoliert
PL Ścisk sprężynowy izolowany
RUS Струбцина изолированная
CZ Pružinové upínadlo izolované
H Rugós szorító
RO Clește presa pt. lemn izolat
F Pince de serrage isolée
I Pinze di bloccaggio isolate
E Pinza aislante
CN 弹簧夹



POLYBAG

YATO	working capacity / zakres pracy (mm)	L (mm)	Box
YT-21190	2-20	150	5/40

GB Quick interchangeable ratchet crimper set
D Kabelschuhzange
PL Zestaw do zaciskania konektorów
RUS Инструмент для обжима и зачистки проводов
CZ Kleště pro svěření zaciskání konekturů
H Krimpelő fogó
RO Clește sertizat conectori
F Pince à sertir pour connecteurs
I Set pinze i compare a connettori
E Pinzas de apretar de conectores
CN 棘轮压线钳组套

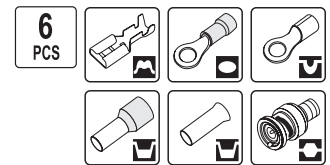

BMC & COLOR SLEEVE

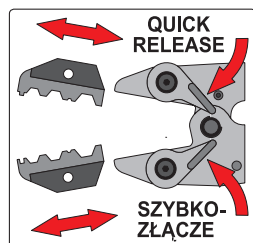

YATO	A		B		C		D		E		Box
	mm ²	AWG	mm ²	AWG	mm ²	AWG	mm ²	AWG	mm ²	AWG	
YT-2245	0.5-6.0	20-10	0.5-6.0	22-10	1.5-10.0	20-8	0.5-4.0	22-12	RG6, RG58, RG59, RG62		10

GB Ratchet crimping pliers
D Kabelschuhzange
PL Szczypce do zaciskania konektorów
RUS Инструмент для обжима и зачистки проводов

CZ Kleště pro svěrání zaciskania konektorů
H Krimpelő fogó
RO Clește sertizat conectori
F Pince pour serrer les connecteurs

I Pinze i compare a connettori
E Pinzas de apretar de conectores
CN 棘轮压线钳

SLIDING
CARD



YATO	mm ²	AWG	Box
YT-2250	0.5-6.0	20-10	5/30

YATO	mm ²	AWG	Box
YT-2300	0.5-6.0	20-10	5/30

GB Ratchet crimping pliers
D Kabelschuhzange
PL Szczypce do zaciskania konektorów
RUS Инструмент для обжима и зачистки проводов

CZ Kleště pro svěrání zaciskania konektorů
H Krimpelő fogó
RO Clește sertizat conectori
F Pince pour serrer les connecteurs

I Pinze i compare a connettori
E Pinzas de apretar de conectores
CN 棘轮压线钳

BLISTER
CARD



YATO	mm ²	AWG	mm ²	AWG	Box
YT-2255	0.08-2.0	28-14	0.12-0.3	26-22	10/60

YATO	mm ²	AWG	mm ²	AWG	mm ²	AWG	Box
YT-2256	0.08-2.0	28-14	0.3-6.0	22-10	0.12-0.3	26-22	10/60

GB Ratchet crimping pliers
D Kabelschuhzange
PL Szczypce do zaciskania konektorów
RUS Инструмент для обжима и зачистки проводов

CZ Kleště pro svěrání zaciskania konektorů
H Krimpelő fogó
RO Clește sertizat conectori
F Pince pour serrer les connecteurs

I Pinze i compare a connettori
E Pinzas de apretar de conectores
CN 棘轮压线钳

SLIDING
CARD



YATO	mm ²	AWG	Box
YT-2296	0.5-6.0	22-10	5/30

YATO	mm ²	AWG	Box
YT-2246	0.5-6.0	22-10	5/30



YATO	mm ²	AWG	Box
YT-2251	0.5-6.0	22-10	5/30

YATO	mm ²	AWG	Box
YT-2302	0.5-6.0	22-10	5/30



YATO	mm ²	AWG	Box
YT-2307	0.5-2.5	22-14	6/36

YATO	Box
YT-2298	RG6, RG58, RG59, RG62 5/30

GB Ratchet crimping pliers
 D Kabelschuhzange
 PL Szczypce do zaciskania konektorów
 RUS Инструмент для обжима и зачистки проводов

CZ Kleště pro svěráni zaciskania konektorů
 H Krimpelő fogó
 RO Clește sertizat conectori
 F Pince pour serrer les connecteurs

I Pinze i compare a connettori
 E Pinzas de apretar de conectores
 CN 棘轮压线钳

SLIDING CARD



YATO	mm ²	AWG	
YT-2247	1.5-10.0	20-8	5/30

YATO	mm ²	AWG	
YT-2297	1.5-10.0	20-8	5/30



YATO	mm ²	AWG	
YT-2299	0.5-4.0	22-12	5/30

YATO	mm ²	AWG	
YT-2249	0.5-4.0	22-12	5/30

GB Ratchet crimping pliers
 D Kabelschuhzange
 PL Szczypce do zaciskania konektorów
 RUS Инструмент для обжима и зачистки проводов

CZ Kleště pro svěráni zaciskania konektorů
 H Krimpelő fogó
 RO Clește sertizat conectori
 F Pince pour serrer les connecteurs

I Pinze i compare a connettori
 E Pinzas de apretar de conectores
 CN 棘轮压线钳

SLIDING CARD



HRC 44-47



YATO	mm ²	
YT-2240	0.2-6.0	6/36

YATO	mm ²	
YT-2305	0.2-6.0	6/36

GB Crimping pliers
 D Kabelschuhzange
 PL Szczypce do zaciskania konektorów
 RUS Инструмент для обжима и зачистки проводов
 CZ Kleště pro svěráni zaciskania konektorů

H Krimpelő fogó
 RO Clește sertizat conectori
 F Pince pour serrer les connecteurs
 I Pinze i compare a connettori
 E Pinzas de apretar de conectores
 CN 棘轮压线钳

SLIDING CARD



CAT.5
HRC 42-48



SK5

YATO		
YT-2242	RJ45	10/60

YATO		
YT-2243	RJ45, RJ11	8/48

SK5



SK5



YATO		
YT-22422	RJ45, RJ11, RJ12	10/60

YATO		
YT-2244	RJ45, RJ11, RJ12, RJ22	10/60

- GB Hydraulic pliers
D Manuelle Hydraulikpresse
PL Ręczna praska hydrauliczna
RUS Ручной гидравлический обжимной инструмент
CZ Ruční hydraulický lis
H Kézi hidraulikus prés
RO Presă hidraulică manuală
F Pince à sertir
I Pressa idraulica manuale
E Prensa hidráulica manual
CN 液压钳



BMC & COLOR SLEEVE



YATO	crimping size range / zakres zaciskania (mm ²) aluminium copper / miedz		L (mm)	pressure / nacisk (T)	crimping jaws size / rozmiar szczęk zaciskających (mm ²)	
YT-22860	10-95	10-120	415	8	10; 16; 25; 35; 50; 70; 95; 120	4
YT-22861	16-185	16-240	470	12	16; 25; 35; 50; 70; 95; 120; 150; 185; 240	3
YT-22862	16-240	16-300	470	18-20	16; 25; 35; 50; 70; 95; 120; 150; 185; 240; 300	3

- GB Crimping pliers
D Kabelschuhzange
PL Szczypce do zaciskania konektorów
RUS Инструмент для обжима и зачистки проводов
CZ Kleště pro svěření zaciskání konektů
H Krimpelő fogó
RO Clește sertizat conectori
F Pince pour serrer les connecteurs
I Pinze i compare a connettori
E Pinzas de apretar de conectores
CN 棘轮压线钳

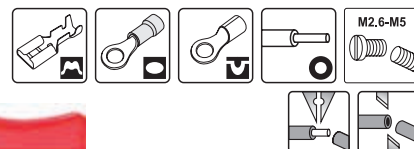

SLIDING CARD

YATO	mm ²		AWG		mm ²		AWG		
YT-2254	0.5-5.0	20-10	0.5-5.0	20-10	0.5-5.5	20-10	0.5-5.0	20-10	12/48

- GB Wire stripper
D Abisolierzange
PL Ściągacz izolacji
RUS Съёмник изоляции
CZ Odizolovací klejtle
H Blankolo fogo
RO Decablator
F Extracteur d'isolation
I Pinze per scariare isolamento
E Extractor de aislado
CN 万用剥线钳

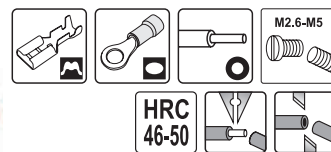

SLIDING CARD

YATO	mm ²		AWG		mm ²		AWG		
YT-22930	1.5-6.0	22-10	1.5-6.0	22-10	0.75-6.0	22-10		12/48	

- GB Wire stripper
D Abisolierzange
PL Ściągacz izolacji
RUS Съёмник изоляции

- CZ Odizolovací klejtle
H Blankolo fogo
RO Decablator

- F Extracteur d'isolation
I Pinze per scariare isolamento

- E Extractor de aislado
CN 万用剥线钳



SLIDING CARD

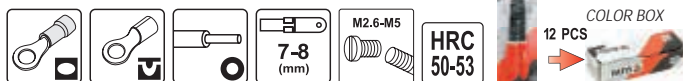

12 PCS

COLOR BOX

YATO	mm ²		AWG		mm ²		AWG		PCS packing	
YT-2293	1.25-2.5	8-12	1.0	8					12	72



SLIDING CARD



YATO	mm ²		AWG		mm ²		AWG		
YT-2295	0.5-6.0	22-10	0.8-2.6	20-10					12/72

GB Wire stripper
 D Abisolierzange
 PL Ściągacz izolacji
 RUS Съёмник изоляции
 CZ Odizolovací klejste

H Blankolo fogo
 RO Decablator
 F Extracteur d'isolation

I Pinze per scaricare isolamento
 E Extractor de aislado
 CN 万用剥线钳

SLIDING CARD

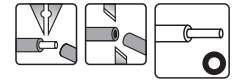

HRC 48-52

YATO	mm ²	AWG	Box
YT-2266	0.25-1.3	30-16	10/60



HRC 48-52

YATO	mm ²	AWG	Box
YT-2267	0.8-2.6	20-10	10/60



HRC 50-53

YATO	mm ²	AWG	Box
YT-2294	0.64-2.6	22-10	12/120



HRC 48-52

YATO	mm ²	AWG	Box
YT-2319	0.8-2.6	20-10	10/60

GB Universal wire stripper & ratchet crimping pliers
 D Multifunktion Abisolierzange & Kabelschuhklemmzange
 PL Uniwersalny ściągacz izolacji i szczypce do zaciskania konektorów

RUS Инструмент для снятия изоляции и зажима проводов
 CZ Univerzální odizolovací klejste & kleště pro svěření zaciskania konektorů
 H Blankolo fogo & krimpeló fogó
 RO Decablator universal & clește sertizat conectori

F Extracteur d'isolation multifonction
 I Pinze per scaricare isolamento
 E Extractor de aislado multifunción
 CN 万用剥线钳



HRC 52-57



7-8 (mm)

HALF DOUBLE BLISTER



YATO	mm ²	AWG	mm ²	AWG	mm ²	AWG	Box
YT-2270	0.5-6.0	22-10	1.5-6.0	22-10	0.2-6.0	24-10	5/30



SLIDING CARD



YATO	mm ²	AWG	mm ²	AWG	mm ²	AWG	Box
YT-2313	0.5-6.0	22-10	1.5-6.0	22-10	0.2-6.0	24-10	5/30

GB Universal wire stripper & ratchet crimping pliers
 D Multifunktion Abisolierzange & Kabelschuhklemmzange
 PL Uniwersalny ściągacz izolacji i szczypce do zaciskania konektorów

RUS Инструмент для снятия изоляции и зажима проводов
 CZ Univerzální odizolovací klejste & kleště pro svěření zaciskania konektorů
 H Blankolo fogo & krimpeló fogó
 RO Decablator universal & clește sertizat conectori
 F Extracteur d'isolation multifonction
 I Pinze per scaricare isolamento
 E Extractor de aislado multifunción
 CN 剥线钳



SLIDING CARD



YATO	mm ²	AWG	mm ²	AWG	Box
YT-2278	0.5-6.0	22-10	0.2-6.0	24-10	10/60

GB Automatic wire stripper
D Automatische Abisolierzange
PL Automatyczny ściągacz izolacji
RUS Клещи для удаления изоляции
CZ Automatický stahovač izolace
H Automatikus szigeteléslehúzó
RO Clește automat pt. desizolat

F Extracteur d'isolation automatique
I Pinze per scaricare isolamento
E Pelacables automatico
CN 万用剥线钳

SLIDING CARD

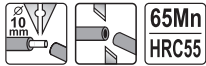

65Mn
HRC55



YATO				
YT-2268				10/60

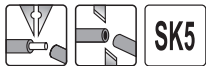

SK5



YATO				
YT-2275	mm ²	AWG		10/60
	0.5-6.0	20-10		



SK5



YATO				
YT-2276	mm ²	AWG		8/48
	1.0-3.2	18-12		



SK5



YATO				
YT-2316	mm ²	AWG		8/48
	1.0-3.2	18-12		

GB Electrical cutter
D Seitenschneider
PL Obcinak elektryczny
RUS Инструмент для обрезки проводов
CZ Elektrické upichováky
H Kábelvágó
RO Clește tăietor - electrician

F Coupeur isolé
I Pinza per elettronica
E Cortacables eléctricos
CN 电子斜嘴钳

130 mm



HRC 55-57

65 Mn



SLIDING CARD

YATO				
YT-2263	mm ²	AWG	L (mm)	
	0.5-1.5	20-18	130	12/120

GB Wire stripper
D Abisolierzange
PL Ściągacz izolacji
RUS Съёмник изоляции
CZ Odizolovací klejtky
H Blankoló foga

RO Decablator
F Extracteur d'isolation
I Pinze per scaricare isolamento

E Extractor de aislado
CN 万用剥线钳



SLIDING CARD

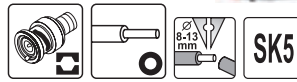

SK5

YATO				
YT-2274	RG9, RG59	mm ²	AWG	
		0.5-6.0	20-10	15/90

GB Electrical cutter
D Seitenschneider
PL Obcinak elektryczny
RUS Инструмент для обрезки проводов
CZ Elektrické upichováky
H Kábelvágó
RO Clește tăietor - electrician

F Coupeur isolé
I Pinza per elettronica
E Cortacables eléctricos
CN 电子斜嘴钳



125 mm

SLIDING CARD

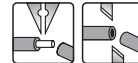

YATO				
YT-2260	mm ²	AWG	L (mm)	
	0.5-1.5	20-18	125	15/150



YATO				
YT-2261	mm ²	AWG	L (mm)	
	0.5-1.5	20-18	125	15/150

GB Electrical cutter
D Seitenschneider
PL Obcinak elektryczny
RUS Инструмент для обрезки проводов
CZ Elektrické upichováky
H Kábelvágó
RO Clește tăietor - electrician
F Coupeur isolé

I Pinza per elettronica
E Cortacables eléctricos
CN 电子斜嘴钳



125 mm



3.0 mm² (max)
STAINLESS STEEL
STAL
MERDEZYNA

SLIDING CARD

YATO				
YT-2262	mm ²	AWG	L (mm)	
	0.5-1.5	20-18	125	20/120

GB Cable cutter
D Kabelschere
PL Szczypce do cięcia przewodów
RUS Кабелперезы
CZ Elektrické upichováky
H Kábelvágó
RO Patent tăietor pt. electrice
F Pince pour câbles

I Cesoia per cavi elettrici
E Tijeras para cables
CN 电缆断线钳

170 mm



3.5 mm

SK5



SLIDING CARD

YATO				
YT-2279	max Ø (mm)		L (mm)	
	10.5		170	10/60

- GB Universal wire stripper
- D Universal Abisolierzange
- PL Uniwersalny ściągacz izolacji
- RUS Универсальный съёмник изоляции
- CZ Univerzální odizolovací klejte
- H Blankolo fogo
- RO Decablator universal
- F Dénuder et coupe-câble outil
- I Pinze per scariare isolamento
- E Extractor de aislado universal
- CN 剥线钳



HALF DOUBLE BLISTER

170 mm



YATO	Ø		L (mm)	Box
	mm ²	AWG		
YT-19691	1.6-3.2	14-8	170	6/24

- GB Cable cutter
- D Kabelschere
- PL Nożyce do kabli
- RUS Кабелерезы
- CZ Elektrické upichováky
- H Kábelvágó
- RO Patent tăietor pt. electricie
- F Cisailles à câbles
- I Cesioie per cavi
- E Tijeras para cables
- CN 电缆剪



STEEL
STAL

COLOR BOX

YATO	cutting range / max. przekrój cięcia (mm ²)	max. Ø (mm)	L (mm)	Box
YT-18610	125	12.5	370	20
YT-18611	250	18.0	580	10
YT-18612	500	25.0	770	5

- GB Cable stripper
- D Kabelmesser
- PL Nożyk do kabli
- RUS Нож кабельный
- CZ Nůž na kabele
- H Kábelkés
- RO Cuițaș pt. cabluri
- F Couteau aux câbles
- I Coltellino per cavi
- E Cuchillo
- CN 电缆剥线钳



SLIDING CARD

Ø mm
8-28



YATO	Ø (mm)	Box
YT-2280	8-28	10/100

- GB Insulated electrician scissors
- D Elektrische Schere
- PL Nożyczki dla elektryków izolowane
- RUS Ножницы диэлектрические универсальные
- CZ Elektrické nůžky
- H Univerzális olló

- RO Foarfece - electrician izolat
- F Ciseaux pour electriciens
- I Forbici per elettricisti
- E Tijeras eléctricos
- CN 绝缘电工剪

160 mm

CrV

1000 V



POLYBAG



1000V VDE CERTIFICATE EN 60900:2012

YATO	L (mm)	Box
YT-21200	160	6/48

- GB Electrician scissors
- D Elektrische Schere
- PL Nożyczki dla elektryków
- RUS Ножницы универсальные
- CZ Elektrické nůžky
- H Univerzális olló
- RO Foarfece - electrician

- F Ciseaux pour electriciens
- I Forbici per elettricisti
- E Tijeras eléctricos
- CN 电工剪

140 mm

STAINLESS STEEL
STAL
MERDEZENA

HRC 52-56

SLIDING CARD



YATO	L (mm)	Box
YT-1974	140	12/120

- GB Insulated cable knife
- D Kabelmesser gerade
- PL Nóż dla elektryków izolowany
- RUS Нож кабельный изолированный
- CZ Izolovaný nůž
- H Szerelőkés

- RO Cutit pt. cabluri izolat
- F Couteau d'électricien
- I Coltello per elettricisti isolato
- E Cuchillo electricista aislante
- CN 绝缘电工刀

180 mm

50 mm

65 Mn

1000 V



POLYBAG



1000V VDE CERTIFICATE EN 60900:2012

YATO	L (mm)	Box
YT-21210	180	6/72

- GB Insulated dismantling knife
- D Abmantelungsmesser
- PL Nóż demontażowy dla elektryków
- RUS Нож кабельный изолированный
- CZ Zahnutý nůž s vodičkem, izolovaný

- H Szerelőkés
- RO Cutit demontabil izolat
- F Couteau d'électricien
- I Coltello di smontaggio per elettricisti isolati
- E Cuchillo de desmontaje aislante
- CN 绝缘电工刀

155 mm

38 mm

65 Mn

1000 V



POLYBAG



1000V VDE CERTIFICATE EN 60900:2012

YATO	L (mm)	Box
YT-21211	155	6/72

GB Electrician's knife
D Montagemesser
PL Nóż składany monterski
RUS Нож складной
CZ Montážní nůž
H Szerelőkés
RO Cuțit pt. decablat
F Couteau d'électricien
I Coltello
E Cuchillo de montaje
CN 电工刀

SLIDING CARD



3CR13

HRC 42-48

85 mm

200 mm



75 mm

190 mm



YATO	L (mm)	
YT-7600	200	6/96

YATO	L (mm)	
YT-7601	190	6/96

GB Cable cutter
D Kabelschere
PL Szczypce do cięcia przewodów
RUS Кабелерезы
CZ Elektrické upichováky
H Kábelvágó
RO Patent tăietor pt. electrice
F Pince à couper les fils
I Pinze per tagliare i cavi
E Tijeras para cables
CN 电缆剪

SLIDING CARD



160 mm

210 mm

240 mm

CrV 50

HRC 55-60



- application: for copper and aluminium electric cables
- przeznaczenie: do cięcia miedzianych i aluminiowych kabli

YATO	L (mm)	max. Ø (mm)	
YT-1966	160	6	6/60
YT-1967	210	7	6/60
YT-1968	240	8	6/48

GB Heavy duty cable cutter
D Schwere Drahtschere
PL Wzmocnione nożyce do cięcia przewodów
RUS Кабелерезы
CZ Elektrické upichováky
H Kábelvágó
RO Patent tăietor pt. electrice
F Pince renforcée à couper les fils
I Pinze per tagliare i cavi
E Tijeras para cables
CN 电缆剪

SLIDING CARD



240 mm

CrV 50

HRC 55-60



- application: for copper and aluminium electric cables
- przeznaczenie: do cięcia miedzianych i aluminiowych kabli

YATO	L (mm)	max. Ø (mm)	
YT-1969	240	9	6/48

GB Heavy duty cable cutter
D Schwere Drahtschere
PL Wzmocnione nożyce do cięcia przewodów
RUS Кабелерезы
CZ Elektrické upichováky
H Kábelvágó
RO Patent tăietor pt. electrice
F Pince renforcée à couper les fils
I Pinze per tagliare i cavi
E Tijeras para cables
CN 电缆剪

SLIDING CARD



230 mm

HRC 58-61

CrMo

Lever for increase cutting power

Ideal for copper and aluminium electric cables



YATO	L (mm)	max. Ø (mm)	
YT-1933	230	9	6/36

GB Insulated cable cutter
D Kabelschere
PL Szczypce do cięcia przewodów izolowane
RUS Кабелерезы
CZ Elektrické upichováky, izolované
H Kábelvágó

RO Cleste tăiat cabluri izolat
F Pince renforcée isolée
I Pinze per tagliare i cavi isolati
E Tijeras para cables aislantes
CN 绝缘电缆剪



250 mm

CrV

1000 V



POLYBAG

1000V VDE CERTIFICATE EN 60900:2012

YATO	L (mm)	max. Ø (mm)	
YT-21141	250	80	6/36

GB Ratchet cable cutter
D Ratschenkabelschneider
PL Nożyce zapadkowe do kabli
RUS Кабелерез секторный
CZ Kleště na kabely, rohatka se západkou
H Racsnis kábelvágó
RO Cleste pt. tăiat cablu cu clichet
F Cisailles à câbles
I Cricchetto taglia cavo
E Cortacables de carraca
CN 棘轮电缆剪

COLOR BOX



Cu/Al CABLE KABEL

60Si2Mn

HRC 50 CUTTING BLADE OSTRZE TNACE



YATO	cutting range / max. przekrój cięcia (mm ²)	max. Ø (mm)	L (mm)	
YT-18600	240	17.5	300	10



YATO	cutting range / max. przekrój cięcia (mm ²)	max. Ø (mm)	L (mm)	
YT-18602	380	22	380	10

GB Digital voltage tester
D Spannungsprüfer
PL Próbnik napięcia
RUS Отвёртка с передачей
CZ Zkoušeč napětí

H Fáziskereső
RO Creion de tensiune
F Testeur de tension type tournevis

I Cerca fase
E Comprobador de corriente
CN 多功能测电笔

PLASTIC HANGER



In accordance with polish standard PN-E 08509:1988
 Zgodny z polską normą PN-E 08509:1988

YATO	⊖	L (mm)	⊞
YT-28300	3.0	190	12/144

GB Digital voltage tester
D Spannungsprüfer
PL Próbnik napięcia
RUS Отвёртка с передачей
CZ Zkoušeč napětí

H Fáziskereső
RO Creion de tensiune
F Testeur de tension type tournevis

I Cerca fase
E Comprobador de corriente
CN 多功能测电笔

SLIDING CARD



1.5-9 V
 50-500 Hz
 CONTINUITY TEST
 TEST CIĄGŁOŚCI
 70-250 V
 70-600 V
 POWER ZASILANE 2x1.5 V LR41 BATTERY*
 *BATTERY NOT INCLUDED (BATERIA NIE DOŁĄCZONO)

YATO	⊞
YT-2864	6/120

GB Digital voltage tester
D Spannungsprüfer
PL Uniwersalny tester elektryczny
RUS Отвёртка с передачей

CZ Zkoušeč napětí
H Fáziskereső
RO Creion de tensiune
F Testeur de tension type tournevis

I Cerca fase digitale
E Comprobador de corriente
CN 测电笔

SLIDING CARD



1.5-9 V
 50-500 Hz
 70-250 V
 70-1000 V
 POWER ZASILANE 2x1.5 V LR44
 CONTINUITY TEST
 TEST CIĄGŁOŚCI

YATO	⊞
YT-28631	6/120

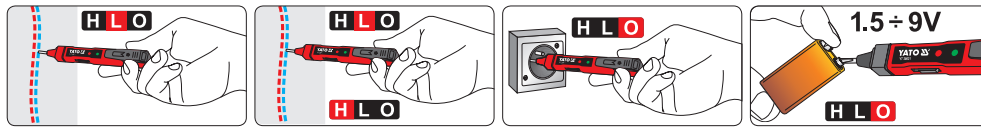

GB Digital voltage tester
D Digitaler-Spannungsprüfer
PL Wskaźnik elektryczny
RUS Тестер напряжения цифровой
CZ Zkoušečka napětí digitální

H Digitális voltmérő
RO Tester digital pt. tensiune electrica
F Testeur de tension type tournevis
I Cerca fase digitale
E Indicador eléctrico digital
CN 数显测电笔

SLIDING CARD

12-250 V ~ / -
 50-500 Hz
 TEST
 LCD DISPLAY WYŚWIETLACZ



NO BATTERY NEEDED
 NIE POTRZEBUJE BATERII

YATO	⊞
YT-2861	20/500



LED
 NO BATTERY NEEDED
 NIE POTRZEBUJE BATERII

YATO	⊞
YT-2862	20/500



LED
 POWER ZASILANE 3x1.5 V LR41 BATTERY EXTERNAL

YATO	⊞
YT-28630	6/120

GB Stud finder
D Entfernungsmesser
PL Wykrywacz profili i przewodów
RUS Цифровой детектор
CZ Digitální detektor
H Digitális kereső műszer
RO Detector digital
F Détecteur de métaux et de câbles électriques
I Detector digitale
E Escáner de pared
CN 墙体探测仪

HANGING COLOR BOX

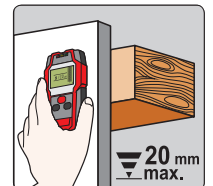
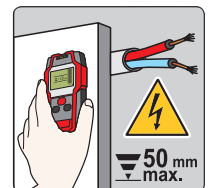
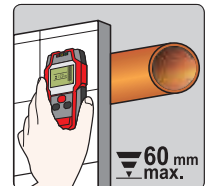
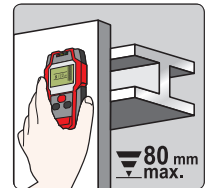

YATO	⊞
YT-73131	40

GB Digital universal multimeter
D Universell digital Messgerät
PL Cyfrowy miernik uniwersalny
RUS Универсальный цифровой измеритель
CZ Digitální multimetr univerzální
H Digitális multiméter
RO Multimetru digital universal
F Multimètre numérique
I Universale tester digitale
E Manómetro digital universal
CN 数字万用表

U 0-500 ~V	U 0-500 ~V	I 0-5 ~A	R 0-2 MΩ
h _{FE} PNP NPN	5V _{P-P}	☺	



COLOR BOX

YATO	
YT-73080	50

U 0-300 ~V	U 0-300 ~V	I 0-10 ~A	I 0-10 ~A	R 0-20 MΩ	C 0-1000 μF
T -20~ +1000°C	h _{FE} PNP NPN	AUTO RANGE AUTO ZAKRES	AUTO POWER OFF	☺	



COLOR BOX

YATO	
YT-73084	44

L1 L2 L3	U 0-600 ~V	U 0-600 ~V	I 0-10 ~A	I 0-10 ~A	R 0-40 MΩ
C 0-100 μF	f 100 kHz	5%+95%	T -20~ +1000°C	AUTO RANGE AUTO ZAKRES	AUTO POWER OFF
					☺



NYLON CASE & COLOR BOX

YATO	
YT-73086	24

5 in 1 5 W 1	U 0-600 ~V	U 0-600 ~V	I 0-10 ~A	I 0-10 ~A	R 0-40 MΩ
C 0-100 μF	f 200 kHz	5%+95%	T -20~ +1000°C	%RH 30%+ 90%	AUTO RANGE AUTO ZAKRES
3.5-100dB	40000 1x	AUTO RANGE AUTO ZAKRES		AUTO POWER OFF	☺



NYLON CASE & COLOR BOX

YATO	
YT-73087	24

U 0-600 ~V	U 0-600 ~V	I 0-600 ~A	R 0-200 MΩ
T -20~ +1000°C	AUTO RANGE AUTO ZAKRES	AUTO POWER OFF	☺



NYLON CASE & COLOR BOX

YATO	
YT-73091	20

GB Electric glue gun
D Heissklebepistole
PL Pistolet do klejenia
RUS Пистолет для клея
CZ Pistole na lepení
H Ragasztópisztoly
RO Pistol pt. lipit
F Pistolet à colle
I Pistola colla
E Pistola de cola
CN 热胶枪

230V~ 50Hz	35 (400) W	150-200 °C	15 g/min
3-6 min	∅ 11 mm	☐	

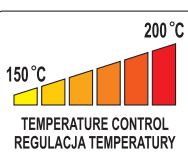

COLOR BOX

YATO	W	diameter of glue stick średnica wkładu (mm)	capacity wydajność (g/min)	
YT-82401	35 (400)	11	15	12/24

GB Electric glue gun
D Heissklebepistole
PL Pistolet do klejenia
RUS Пистолет для клея
CZ Pistole na lepení
H Ragasztópisztoly
RO Pistol pt. lipit
F Pistolet à colle
I Pistola colla
E Pistola de cola
CN 热胶枪

DOUBLE
BLISTER

230V~ 50Hz	20 (80) W	180-200 °C	15 g/min
3-5 min	3x ∅11mm	☐	



YATO	W	diameter of glue stick średnica wkładu (mm)	capacity wydajność (g/min)	
YT-82402	20 (80)	11	15	12/48

- GB Soldering station
- D Lötstation
- PL Stacja lutownicza
- RUS Паяльная станция
- CZ Letovací stanice
- H Forrasztópáka állomás
- RO Stație de lipit
- F Station de soudage
- I Stazione digitale di saldatura
- E Estación de soldadura
- CN 数显焊台



230V~50Hz	48W	150-450°C	
7.1 mm / 65 mm			



YATO	W	
YT-82455	48	4

- GB Soldering iron
- D Lötkolben
- PL Lutownica oporowa
- RUS Электропаяльник
- CZ Pájka odporová
- H Forrasztópáka
- RO Ciocan de lipit
- F Fer à souder
- I Saldatore a stagno
- E Soldador de resistencia
- CN 电烙铁



230V~50Hz	400-520°C	2-3 min
-----------	-----------	---------

YATO	W	max. temperature of soldering tip / max. temperatura grotu (°C)	dimensions of soldering tip / wymiary grotu (mm)	
YT-8271	30	400	ø3.8 x 70	16
YT-8272	60	500	ø6.0 x 78	16
YT-8273	80	520	ø6.8 x 64	16

7

- GB Transformer soldering gun
- D Lötpestole
- PL Lutownica transformatorowa
- RUS Паяльник электрический
- CZ Transformátorová páječka
- H Forrasztópáka
- RO Aparat de lipit letcon cu transformator
- F Fer à souder
- I Saldatore istantaneo
- E Soldador transformador
- CN 电烙铁

230V~50Hz	180W		

- GB Transformer soldering gun
- D Lötpestole
- PL Lutownica transformatorowa
- RUS Паяльник электрический
- CZ Transformátorová páječka
- H Forrasztópáka
- RO Aparat de lipit letcon cu transformator
- F Fer à souder
- I Saldatore istantaneo
- E Soldador transformador
- CN 电烙铁

230V~50Hz	200W		



WORK LIGHT
OŚWIETLENIE PRACY

BMC & COLOR SLEEVE

YATO	W	
YT-8245	180	10



WORK LIGHT
OŚWIETLENIE PRACY

BMC & COLOR SLEEVE

YATO	W	
YT-82451	200	10

- GB Desoldering pump
- D Entlötsaugpumpe
- PL Odsysacz do cyny
- RUS Шприц для удаления припоя
- CZ Odrpájecí sací pumpa
- H Ónszippantó
- RO Pompa fluorid
- F Pompe à étain
- I Pompa aspira stagno
- E Bomba desoldadora
- CN 全铝手动吸锡器

SLIDING CARD

PTFE TIP



YATO	
YT-82742	100/400



YATO	
YT-82743	100/200



YATO	
YT-82744	50/100

GB Tweezer CZ Pinzeta I Pinza
D Pinzette H Csipesz E Pinzas
PL Pęseta RO Pensetă CN 镊子
RUS Пинцет F Pince

SLIDING
CARD



302
STAINLESS
STEEL
STAL
NERDZEWNIA

ANTI
MAGNETIC
ANTYMAC-
NETYCZNA

ANTI ACID
KWASO-
ODPORNA



140
mm

HRC
30

YATO	L (mm)	
YT-6903	140	20/480



115
mm

HRC
30

YATO	L (mm)	
YT-6907	115	20/240



140
mm

HRC
40

YATO	L (mm)	
YT-6916	140	20/240

GB Insulation tape RO Banda izolatoare
D Isolierband F Ruban électrique
PL Taśma elektroizolacyjna I Nastro isolante
RUS Изолента E Cinta aislante
CZ Izolační páska CN 绝缘胶带
H Szigetelőszalag

EN60454-3-1-1/F-PVC/60/R-Tp
DIELECTRIC STRENGTH / WYTRZYMAŁOŚĆ DIELEKTRYCZNA > 35 Kv / mm
ELONGATION / WYDŁUŻENIE > 125%
FLAME TEST / TEST OGNIOWY < 1 s
STORE TEMPERATURE / TEMPERATURA SKŁADOWANIA +10°C ~ +40°C
USING TEMPERATURE / TEMPERATURA UŻYTKOWANIA +5°C ~ +50°C



YATO	dimensions / wymiary	
YT-8152	12 mm x 10 m x 0.13 mm	96/384
YT-8159	15 mm x 20 m x 0.13 mm	72/288
YT-8165	19 mm x 20 m x 0.13 mm	72/288
YT-8174	25 mm x 20 m x 0.19 mm	48/192
YT-8177	50 mm x 33 m x 0.19 mm	48

YATO	dimensions / wymiary	
YT-81592	15 mm x 20 m x 0.13 mm	72/288
YT-8166	19 mm x 20 m x 0.13 mm	72/288

YATO	dimensions / wymiary	
YT-81591	15 mm x 20 m x 0.13 mm	72/288
YT-81651	19 mm x 20 m x 0.13 mm	72/288



YATO	dimensions / wymiary	
YT-81594	15 mm x 20 m x 0.13 mm	72/288
YT-81654	19 mm x 20 m x 0.13 mm	72/288

YATO	dimensions / wymiary	
YT-81593	15 mm x 20 m x 0.13 mm	72/288
YT-81655	19 mm x 20 m x 0.13 mm	72/288

YATO	dimensions / wymiary	
YT-81595	15 mm x 20 m x 0.13 mm	72/288
YT-81652	19 mm x 20 m x 0.13 mm	72/288



10
PCS

10
PCS

YATO	dimensions / wymiary	
YT-8156	12 mm x 10 m x 0.13 mm	10/40

YATO	dimensions / wymiary	
YT-8173	19 mm x 20 m x 0.13 mm	6/24

- GB** Tool set for electricians
D Werkzeug-Set für Elektriker
PL Zestaw narzędziowy dla elektryków
RUS Набор инструментов для электриков
CZ Sada nářadí pro elektrikáře
- H** Szerszámkészlet villanyszerelők
RO Set de instrumente pt. electricieni
F Un ensemble d'outils pour les électriciens
- I** Set per l'elettricista
E Um conjunto de ferramentas para electricistas
CN 件电子绝缘工具组套

BMC & COLOR SLEEVE



68 PCS	1/4" 6.3mm	CrV 50BV30	CrV 6150
S2	1000 V		



- 1/4" (6.3 mm):** 4, 4.5, 5, 5.5, 6, 7, 8, 9, 10, 11, 12, 13 mm (L=25 mm); CrV 50BV30;
 140 mm; 190 mm; 3CRB; 150 mm;
 160 mm; 1000 V; CrV; 160 mm; 1000 V; CrV;
 3 m x 16 mm; 175 mm; 19.5 x 190 mm;
- 1.5 V; 9 LED; 9 mm; 19 mm x 20 mm;
 1/4" (6.3 mm); (150 mm); CrV 50BV30;
 1/4" (6.3 mm) x 1/4" (6.3 mm); CrV 6140; 10 g;
 1.4, 2, 2.4 mm; PH00, PH0, PH1; S2;
 4x75, 5.5x125, PH1x80, PH2x100 mm; 1000V; S2;
 1/4" (6.3 mm): 3, 4, 5, 5.5, 6 mm (L=25 mm); AISI S2;
 1/4" (6.3 mm): PH1, PH2, PH3 (L=25 mm); AISI S2;
 1/4" (6.3 mm): T8, T10, T15, T20, T25, T27 (L=25 mm); AISI S2;
 1/4" (6.3 mm): 2, 2.5, 3, 4, 5, 6 (L=25 mm); AISI S2;
 1.5, 2, 2.5, 3, 4, 5, 6, 7, 8, 10 mm; CrV 6150



U 0-500 V	U 0-500 ~V	I 0-5 A	R 0-2 MΩ	
h_{FE} PNP NPN		5V_{PP}		



12-250 V	50-500 Hz	LCD DISPLAY	NO BATTERY NEEDED NIE POTRZEBUJE BATERII
--------------------	---------------------	-----------------------	---



30W	230V~ 50Hz	400°C	TIP Ø3.8x70 mm
------------	----------------------	--------------	--------------------------

YATO		
YT-39009	1/4" (6.3 mm)	2

- GB** Electrical clip assortment
D Krokodil-Klemmen-Kortiment
PL Zestaw złącz elektrycznych - krokodylki
RUS Набор разъемов - крокодил
CZ Terminal alligator krokodil přichytek
H Krokodil csipesz készlet
RO Sortiment cleme crocodil
F Assortiment pinces crocodile
I Set di perni per misure e prove
E Crocodile clip
CN 件套夹头组套

PLASTIC HANGING BOX



28
PCS
MIX
SIZE
ROZMIAROW



- 10 pcs / sztuk - Alligator - clip without insulation / Krokodylki niezolowane
 6 pcs / sztuk - Alligator - clip insulation / Krokodylki izolowane
 4 pcs / sztuk - Big charging clip insulation / Zaciski duże izolowane
 6 pcs / sztuk - Mini alligator - clip / Krokodylki male izolowane
 2 pcs / sztuk - Small charging clip insulation / Zaciski male izolowane

YATO	dimensions / wymiary (mm)	
YT-06870	50; 55; 60; 65; 70; 80	5/20

- GB** Terminal connectors
D Kabelschuhe schnellkupplung kabelklemme
PL Zestaw szybkozłącz elektrycznych
RUS Набор экспресс-клемм
CZ Kabelova rychlospojka
H Gyors csatlakozó auto
RO Conector rapid pt. auto
F Connecteur rapide
I Connettori terminali
E Conector rapido electrico
CN 件套连接片组套

PLASTIC HANGING BOX



50
PCS
MIX
SIZE
ROZMIAROW

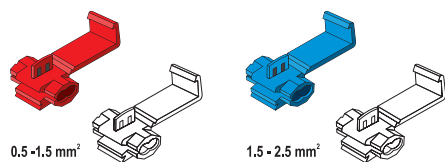

YATO	dimensions / wymiary (mm²)	
YT-06868	0.5-1.5; 1.5-2.5	5/20

- GB** Heat-shrink tubing set
D Schrumpfschlauch - sortiment
PL Zestaw koszulek termokurczliwych
RUS Набор термоусадочных трубок
CZ Smřšťovací bužírka tepelné
H Hőre zsugorodó cső szettek
RO Set tuburi termocontractabile
F Set tube thermoretractable
I Tubo termoretraibile per isolare
E Surtido tubo de conexión eléctrica cable manga
CN 件套热收缩管

PLASTIC HANGING BOX



127
PCS
MIX
SIZE
ROZMIAROW
125°C
max.
600 V
max.



- Ø 2.0 x 40, 2.5 x 40, 3.5 x 40, 5.0 x 40,
 7.0 x 80, 10.0 x 80, 13.0 x 85 mm

YATO	dimensions / wymiary (mm)	
YT-06866		5/20

Memo

8

**Hammers, chisels,
punches & axes**

**Młotki, dłuta,
przecinaki i siekiery**



Machinist hammers Młotki ślusarskie	
130	

Ball pein hammers & sets Młotki blacharskie i zestawy	
132	

Stoning hammers Młotki kamieniarskie	
130	

Chisels, cold chisels & punches Dłuta, przecinaki i przebijaki	
133-135	

Hammers with tubular steel handle Młotki z trzonkiem rurowym	
131	

Wood chisels & sets Dłuta stolarskie i zestawy.....	133
Cold chisels Przecinaki.....	133
Punches Przebijaki.....	133
Pin punches Wybijaki.....	134
Punches Punktaki.....	134
Cold chisel & punch sets Zestawy przecinaków i punktaków.....	134

Claw hammers Młotki szewskie.....	131
Roofing hammers Młotki ciesielskie.....	131
Mason's hammers Młotki murarskie.....	131
Plasterer's hatchets Toporki tynkarskie.....	131

Wrecking bars Łomy	
136	

Fully drop forged hammers Młotki monolityczne kute	
131	

Axes Siekiery	
136	

Claw hammers Młotki szewskie.....	131
Roofing hammers Młotki ciesielskie.....	131
Mason's hammers Młotki murarskie.....	131

Adzes Ciosła	
136	

Rubber mallets Młotki gumowe	
132	

Dead blow hammers Młotki bezodrzutowe	
132	

GB Machinist hammer CZ Zámečnické kladívko I Martello da aggiustatore
 D Schlosserhammer H Vaskalapács E Martillo
 PL Młotek ślusarski RO Ciocan de lăcătușerie CN 钳工锤
 RUS Молоток слесарный F Marteau serrurier

DIN
1041

Safety protection steel ring
Klin pierścieniowy zapewniający bezpieczeństwo

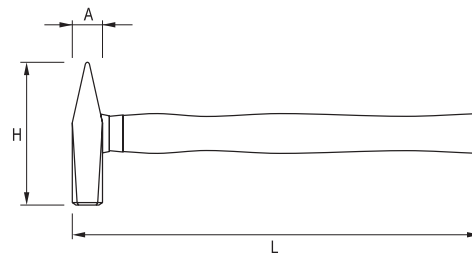

YATO	m (g)	L (mm)	A (mm)	H (mm)	
YT-4491	100	260	15	80	12/120
YT-4492	200	280	20	93	6/60
YT-4493	300	300	21	103	6/60
YT-4494	400	310	23	111	6/48
YT-4495	500	320	26	118	6/36

YATO	m (g)	L (mm)	A (mm)	H (mm)	
YT-4496	600	330	28	119	6/36
YT-4497	800	350	31	125	6/24
YT-4498	1000	360	35	132	6/24
YT-4499	1500	380	40	143	6/12
YT-4500	2000	400	45	153	6/12

8

Safety protection steel ring
Klin pierścieniowy zapewniający bezpieczeństwo

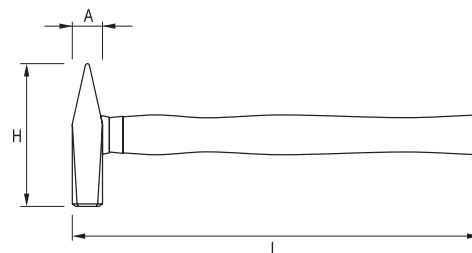

YATO	m (g)	L (mm)	A (mm)	H (mm)	
YT-4501	100	260	15	82	12/120
YT-4502	200	280	19	95	6/60
YT-4503	300	300	23	105	6/60
YT-4504	400	310	25	112	6/48
YT-4505	500	320	27	118	6/36

YATO	m (g)	L (mm)	A (mm)	H (mm)	
YT-4506	600	330	29	122	6/36
YT-4507	800	350	33	135	6/24
YT-4508	1000	360	36	135	6/24
YT-4509	1500	380	42	145	6/12
YT-4510	2000	400	47	155	6/12

GB Safety stoning hammer H Kőtörő kalapács I Martello da aggiustatore
 D Faustel RO Ciocan pt. zidarie E Martillo
 PL Młotek kamieniarski F Marteau de tailleur CN 石工锤
 RUS Молоток каменщика de pierres
 CZ Palička kovová

DIN
6475

Safety protection steel ring
Klin pierścieniowy zapewniający bezpieczeństwo

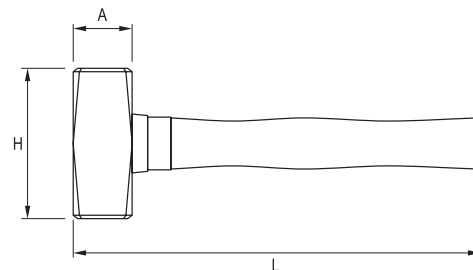

YATO	m (g)	L (mm)	A (mm)	H (mm)	
YT-4550	1000	260	40	95	6/24
YT-4551	1250	260	43	100	6/24

YATO	m (g)	L (mm)	A (mm)	H (mm)	
YT-4552	1500	280	45	110	6/12
YT-4553	2000	300	50	120	6/12

GB Claw hammer
D Schusterhammer
PL Młotek szewski
RUS Молоток гвоздодёр
CZ Ševcovské kladívko
H Cipész kalapács

RO Ciocan de cizmărie
F Marteau de cordonnier
I Martello calzolaio
E Martillo sacador
CN 羊角锤



- high quality steel handle
- forged carbon steel head hardened and tempered
- stalowy trzonek
- bijak ze stali węglowej, kuty, ulepszony cieplnie

YATO	m (g)	L (mm)	A (mm)	H (mm)	
YT-4560	450	318	30	130	6/24

GB Mason's hammer, type B
D Berliner Mauerhammer
PL Młotek murarski berliński
RUS Молоток каменщика широкий

F Marteau de maçon
I Martello muratore tipo Berlin
E Martillo de albañil de Berlín
CN B型泥工锤

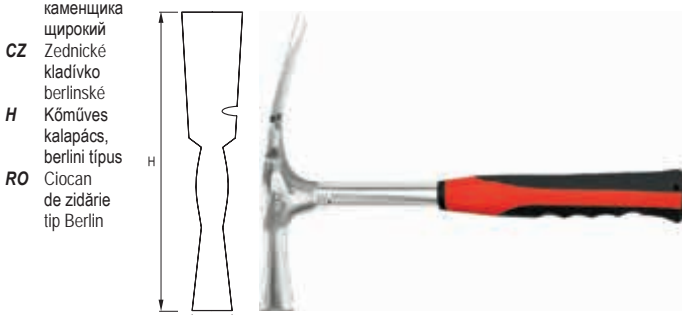

- high quality steel handle
- forged carbon steel head hardened and tempered
- stalowy trzonek
- bijak ze stali węglowej, kuty, ulepszony cieplnie

YATO	m (g)	L (mm)	A (mm)	H (mm)	
YT-4562	600	315	24x23	200	6/24

GB Plasterer's hatchet
D Gipserbeil
PL Toporek tynkarski
RUS Топор штукатурный
CZ Omitáči sekyrka
H Kőműves szekerce
RO Toporaș de tencuit
F Hachette de plâtrier
I Martello con accetta
E Hacha enlucido
CN 多用斧



- high quality steel handle
- forged carbon steel head hardened and tempered
- stalowy trzonek
- bijak ze stali węglowej, kuty, ulepszony cieplnie

YATO	m (g)	L (mm)	A (mm)	H (mm)	
YT-4564	600	315	25x20	175	6/24

GB Roofing hammer
D Latthammer Geschmiedet
PL Młotek ciesielski
RUS Молоток желязячкіца
CZ Tesařské kladívko
H Ácskalapács
RO Ciocan de dulgherie

F Marteau de charpentier
I Martello calzolaio
E Martillo techumbre
CN 连体独角锤



- high quality steel handle
- forged carbon steel head hardened and tempered
- stalowy trzonek
- bijak ze stali węglowej, kuty, ulepszony cieplnie

YATO	m (g)	L (mm)	A (mm)	H (mm)	
YT-4571	600	331	25x25	165	6/24

GB Roofing hammer
D Latthammer Geschmiedet
PL Młotek ciesielski
RUS Молоток желязячкіца
CZ Tesařské kladívko

H Ácskalapács
RO Ciocan de dulgherie
F Marteau de charpentier

I Martello per carpentiere
E Martillo techumbre
CN 独角锤



- high quality steel handle
- forged carbon steel head hardened and tempered
- stalowy trzonek
- bijak ze stali węglowej, kuty, ulepszony cieplnie

YATO	m (g)	L (mm)	A (mm)	H (mm)	
YT-4561	600	318	25x25	165	6/24

GB Mason's hammer, type R
D Mauerhammer Rheinische Form
PL Młotek murarski reński
RUS Молоток каменщика узкий
CZ Zednické kladívko renské
H Kőműves kalapács, rajnai típus

RO Ciocan de zidărie (tip ren)
F Marteau de maçon
I Martello muratore tipo rin
E Martillo de albañil de Rin
CN R型泥工锤



- high quality steel handle
- forged carbon steel head hardened and tempered
- stalowy trzonek
- bijak ze stali węglowej, kuty, ulepszony cieplnie

YATO	m (g)	L (mm)	A (mm)	H (mm)	
YT-4563	600	315	23x23	170	6/24

GB Claw hammer
D Schusterhammer
PL Młotek szewski
RUS Молоток гвоздодёр
CZ Ševcovské kladívko
H Cipész kalapács
RO Ciocan de cizmărie
F Marteau de cordonnier
I Martello calzolaio
E Martillo sacador
CN 连体羊角锤



- high quality steel handle
- forged carbon steel head hardened and tempered
- stalowy trzonek
- bijak ze stali węglowej, kuty, ulepszony cieplnie

YATO	m (g)	L (mm)	A (mm)	H (mm)	
YT-4570	450	315	30	130	6/24

GB Mason's hammer, type R
D Mauerhammer Rheinische Form
PL Młotek murarski reński
RUS Молоток каменщика узкий
CZ Zednické kladívko renské
H Kőműves kalapács, rajnai típus

RO Ciocan de zidărie (tip ren)
F Marteau de maçon
I Martello muratore tipo rin
E Martillo de albañil de Rin
CN 连体R型泥工锤



- high quality steel handle
- forged carbon steel head hardened and tempered
- stalowy trzonek
- bijak ze stali węglowej, kuty, ulepszony cieplnie

YATO	m (g)	L (mm)	A (mm)	H (mm)	
YT-4573	600	382	25x24	158	6/24

- GB** Rubber mallet with fibreglass, TPR handle
D Gummihammer mit Fiberglasstiel
PL Młotek gumowy z trzonkiem z włókna szklanego
RUS Киянка резиновая со стеклопластиковой ручкой
CZ Pryžové kladívko
H Gumikalapács
RO Ciocan de cauciuc
F Maillet caoutchouc
I Martello mazzuola in gomma
E Mazo de goma
CN 纤维柄橡胶锤



YATO	m (g)	L (mm)	Ø (mm)	H (mm)	
YT-4594	440	340	50	87.5	6/36

- GB** Rubber mallet with wooden handle
D Gummihammer mit Holzstiel
PL Młotek gumowy z drewnianym trzonkiem
RUS Молоток резиновый
CZ Pryžové kladívko
H Gumikalapács
RO Ciocan de cauciuc
F Maillet caoutchouc
I Martello mazzuola in gomma
E Mazo de goma
CN 木柄橡胶锤



YATO	m (g)	L (mm)	Ø (mm)	H (mm)	
YT-4600	230	259	44	71.0	12/48
YT-4601	340	291	49	79.5	12/48
YT-4602	370	300	50	87.5	6/36
YT-4603	580	341	58	96.0	6/36
YT-4604	780	341	63	117.0	6/36
YT-4605	980	345	72	122.0	6/24

- GB** Dead blow mallet
D Rückschlagsfreier Schonhammer
PL Młotek bezodrzutowy
RUS Молоток безинерционный
CZ Palička nárazová plněná celogumová
H Visszarúgás mentes gumikalapács
RO Ciocan cu absorbție
F Maillet sans recul
I Martello morto colpo
E Martillo sin reacción
CN 防震无回弹橡胶锤

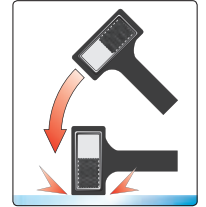

PU



YATO	m (g)	L (mm)	Ø (mm)	H (mm)	
YT-4620	740	300	44.5	100.0	4/24
YT-4622	900	336	53.5	100.0	4/24
YT-4623	1300	350	59.0	118.5	3/12

- GB** Dead blow mallet
D Rückschlagsfreier Schonhammer
PL Młotek bezodrzutowy
RUS Молоток безинерционный
CZ Palička nárazová plněná celogumová
H Visszarúgás mentes gumikalapács
RO Ciocan cu absorbție
F Maillet sans recul
I Martello morto colpo
E Martillo sin reacción
CN 防震无回弹橡胶锤

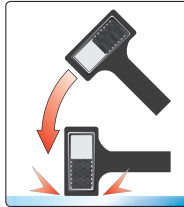

FIBREGLASS
WŁÓKNO
SZKLANE



YATO	m (g)	L (mm)	dimensions / wymiary (mm)	
YT-46270	2.4	490	70x70x140	2/6
YT-46273	5.5	900	105x105x180	2

- GB** Dead blow mallet
D Rückschlagsfreier Schonhammer
PL Młotek bezodrzutowy
RUS Молоток безинерционный
CZ Palička nárazová plněná celogumová
H Visszarúgás mentes gumikalapács
RO Ciocan cu absorbție
F Maillet sans recul
I Martello morto colpo
E Martillo sin reacción
CN 尼龙安装锤

PU



YATO	m (g)	L (mm)	Ø (mm)	H (mm)	
YT-4624	265	318	30.0	94	10/40
YT-4625	430	350	40.0	100	6/36
YT-4626	490	348	45.0	110	6/36

- GB** PU & nylon heads mallet
D Schonhammer mit PU & Nylon-Schlagkopf
PL Młotek blacharski
RUS Молоток рихтовочный
CZ Palička klempířská
H Vaskalapács
RO Ciocan tinichigerie cap PU / nylon
F Marteau spécial en PU / nylon
I Martello per lamiera
E Martillo chapista
CN 木柄安装锤

PU

NYLON



YATO	m (g)	L (mm)	Ø (mm)	H (mm)	
YT-4630	150	250	22	75	6/48
YT-4631	250	280	28	85	6/36
YT-4632	340	315	35	95	6/36
YT-4633	660	350	45	105	6/24
YT-4634	1340	380	60	132	4/16

- GB** Auto body fender set
D Karosserie-Ausbeulsatz
PL Komplet młotków blacharskich
RUS Молотки рихтовочные
CZ Souprava klempířských kladívek
H Bádogos kalapács készlet
RO Set de ciocane de tablă
F Set pour carrossier
I Martello per lamiera
E Juego de mazos de hojalatero
CN 钣金工具组套

7 PCS

DROP FORGED KUTE

GENUINE HICKORY



BMC & COLOR SLEEVE



YATO	m (g)	
YT-4590	4900	4

- GB** Ball pein hammer
D Ausbeulhammer
PL Młotek blacharski
RUS Молоток рихтовочный
CZ Klempířské kladívko
H Bádogos kalapács
RO Ciocan pt. tabla
F Marteau à panne ronde
I Martello per lamiera
E Martillo de hojalatero
CN 圆头锤

FIBREGLASS
WŁÓKNO
SZKLANE



YATO	m (g)	L (mm)	A (mm)	H (mm)	
YT-4515	225	280	26	80	6/36
YT-4516	450	315	34	100	6/24
YT-4518	900	380	40	125	6/12

- GB** Ball pein hammer
D Ausbeulhammer
PL Młotek blacharski
RUS Молоток рихтовочный
CZ Klempířské kladívko
H Bádogos kalapács
RO Ciocan pt. tabla
F Marteau à panne ronde
I Martello per lamiera
E Martillo de hojalatero
CN 圆头锤



YATO	m (g)	L (mm)	A (mm)	H (mm)	
YT-4519	225	295	26	80	6/36
YT-4520	450	335	35	100	6/24
YT-4521	680	360	36	115	6/12
YT-4522	900	380	40	125	6/12

Hammers, chisels, punches & axes Młotki, dłuta, przecinaki i siekiery



- GB** Wood chisel
D Stechbeitel
PL Dłuto stolarskie
RUS Долото
CZ Rezbářské dláto
H Asztalos véső
- RO** Daltă de tâmplărie
F Ciseau
I Scalpello per falegname
E Cincel para madera
CN 木工凿

DOUBLE
BLISTER

CrV
60

HRC
56-62



YATO	size / rozmiar (mm)	
YT-6241	8	10/60
YT-6242	10	10/60
YT-6243	12	10/60
YT-6244	14	10/60
YT-6245	15	10/60
YT-6246	16	10/60
YT-6247	18	10/60

YATO	size / rozmiar (mm)	
YT-6248	20	10/60
YT-6249	22	10/60
YT-6251	25	10/60
YT-6253	28	10/60
YT-6256	35	10/60
YT-6258	38	10/60

- GB** Chisel set
D Meißelsatz
PL Zestaw dłut
RUS Набор зубил
- CZ** Sada dlát
H Hidegvágó készlet
RO Set de dălți
F Set de ciseaux à bois
- I** Set scalpelli
E Juego de cinceles
CN 木工凿组套

4
PCS

10 16
20 25
mm

CrV
60

HRC
58-60



DOUBLE
BLISTER

YATO	
YT-6260	5/20

- GB** Chisel set
D Meißelsatz
PL Zestaw dłut
RUS Набор зубил
- CZ** Sada dlát
H Hidegvágó készlet
RO Set de dălți
F Set de ciseaux à bois
- I** Set scalpelli
E Juego de cinceles
CN 木工凿组套

3
PCS

CrV

16 25
32 mm

PLASTIC
HANGER



YATO	
YT-6280	10/30

- GB** Chisel set
D Meißelsatz
PL Zestaw dłut
RUS Набор зубил
- CZ** Sada dlát
H Hidegvágó készlet
RO Set de dălți
F Set de ciseaux à bois
- I** Set scalpelli
E Juego de cinceles
CN 木工凿组套

4
PCS

CrV

10 12
16 20
mm

PLASTIC
HANGER



YATO	
YT-6281	6/24

- GB** Cold chisel with protection
D Schlitzmeißel mit Handschutz
PL Przecinak z osłoną
RUS Зубило с протектором
CZ Plochý sekáč (z krytem)
H Hidegvágó, lapos (védőfejjel)
- RO** Daltă - tăietor plată (cu apărătoare)
F Burin
I Scalpello con protezione
E Cincel plano (con protector)
CN 石工凿

25x300
mm

CrV



PLASTIC
HANGER

YATO	L (mm)	
YT-4700	300	4/24

- GB** Cold chisel with protection
D Schlitzmeißel mit Handschutz
PL Przecinak z osłoną
RUS Зубило с протектором
CZ Plochý sekáč (z krytem)
H Hidegvágó, lapos (védőfejjel)
RO Daltă - tăietor plată (cu apărătoare)
- F** Burin
I Scalpello con protezione
E Cincel plano (con protector)
CN 石工凿

76x267
mm

CrV

PLASTIC
HANGER



YATO	L (mm)	
YT-4701	267	4/24

- GB** Punch with protection
D Spitzmeißel mit Handschutz
PL Przebijak z osłoną
RUS Скарпель с пластмассовой ручкой
CZ Zednický průbojník (z krytem)
H Falvéső (védőfejjel)
RO Dorn (perforator) pt. perete (cu apărătoare)
F Perçoir
I Scalpello a punta con protezione
E Cincel de cerrajería con protector
CN 水泥尖凿

300
mm

CrV



PLASTIC
HANGER

YATO	L (mm)	
YT-4705	300	4/24

- GB** Chisel and punch set
D Trennmeißel- und Durchtreiber-Satz
PL Zestaw przecinaków i punktaków
RUS Зубила и пробойники с протектором
CZ Sekáče a průbojníky
H Véső és lyukasztó készlet
- RO** Set dalti de impact
F Kit de burins et perçoirs
I Scalpelli e bulino
E Juego de cinceles de acero templado y punzones
CN 冲凿组套

180
mm

6
PCS

CENTER PUNCH
PUNKTAK
∅ 3mm

PIN PUNCH
WYBIJAK
∅ 3 mm
∅ 4 mm

CHISEL
PRZECINAK
12 mm
16 mm
19 mm

CrV



PLASTIC
HANGER

YATO	L (mm)	
YT-4710	180	10/20

- GB** Cold chisel
D Flachmeißel
PL Przęcinak płaski
RUS Зубило плоское
CZ Sekáč plochý
H Laposvágó
- RO** Dalta lata
F Burin
I Scalpello a punta
E Tajadera en frío
CN 凿子



YATO	L (mm)	chisel width / szerokość przycinaka (mm)	
YT-47147	142	10.0	20/120
YT-47148	152	12.5	20/120
YT-47149	172	16.0	20/120

- GB** Taper punch
D Durchtreiber
PL Wybijak równoległy
RUS Пробойник конусный
CZ Průbojník
H Lyukasztó
- RO** Dorn conic
F Percuteur
I Scalpello a punta
E Retacador de cono
CN 冲子



YATO	L (mm)	pin diameter / średnica grotu (mm)	
YT-47141	150	1.5	20/120
YT-47142	150	3.0	20/120
YT-47143	150	4.0	20/120
YT-47144	150	5.0	20/120
YT-47145	150	6.0	20/120
YT-47146	150	8.0	20/120

- GB** Taper punch
D Durchtreiber
PL Dobijak stożkowy
RUS Пробойник конусный
CZ Průbojník
H Lyukasztó
RO Dorn conic
- F** Matoir
I Scalpello a punta
E Retacador de cono
CN 冲子



YATO	L (mm)	taper punch / średnica wybijaka stożkowego (mm)	
YT-47152	140	2.0	20/120

- GB** Center punch
D Körner
PL Punktak
RUS Пробойник - керн
CZ Důlčik
H Pontozó
RO Punctator
- F** Pointeau
I Punzoni
E Retacador - punzón centrador
CN 冲子



YATO	L (mm)	center punch / średnica punktaka (mm)	
YT-47150	100	6.0	20/120
YT-47151	112	8.0	20/120

- GB** Pin punch set
D Splintentreiber Satz
PL Zestaw wybijaków
RUS Пробойник булавочный- набор
CZ Sada vyrážeců
H Csapszegkiütő készlet
- RO** Set de dornuri
F Set de perceuteurs
I Set scalpelli
E Juego de punzones
CN 销式冲子组套

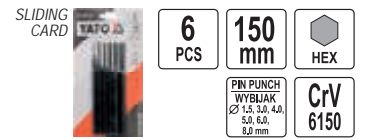

YATO	L (mm)	
YT-47121	150	6/24

- GB** Chisel set
D Flachmeißelsatz
PL Zestaw przycinaków
RUS Зубила в наборе
CZ Sekáče
H Hidegvágó
- RO** Set dalti zidarie
F Set de burins
I Set scalpelli
E Cinceles
CN 冲凿组套



YATO	
YT-4711	6/24

- GB** Chisel and punch set
D Trennmeißel- und Durchtreiber-Satz
PL Zestaw przycinaków i punktaków
RUS Зубила, керны и пробойники в наборе
CZ Sekáče a průbojníky
H Véső és lyukasztó készlet
RO Set dalți de impact
F Set de burins et pointeaux
I Set scalpelli
E Juego de cinceles de acero templado y punzones
CN 冲凿组套



YATO	
YT-4712	6/24

- GB** Mini cold chisel and punch set
D Trennmeissel- und Durchtreiber-Satz
PL Zestaw wybijaków i przecinak
RUS Зубила и керны в наборе
CZ Sekáče a průbojníky
H Véső és lyukasztó készlet
RO Set dalti de impact
F Set de burins et perceuteurs mini
I Set scalpelli e bulini
E Juego de cinceles de acero templado y punzones
CN 迷你冲凿组套

PLASTIC HANGER



3 PCS
125 mm
 CHISEL PRZECINAK 10 mm
 PIN PUNCH WYBIJAK Ø3 mm
 TAPER PUNCH WYBIJAK STOŻKOWY Ø3 mm
CrV



YATO **YT-4713** 10/60

- GB** Chisel and punch set
D Trennmeissel- und Durchtreiber-Satz
PL Zestaw przecinaków i punktaków
RUS Зубила, керны и пробойники в наборе
CZ Sekáče a průbojníky
H Véső és lyukasztó készlet
RO Set dalti de impact
F Set de burins et pointeaux
I Set scalpelli
E Juego de cinceles de acero templado y punzones
CN 冲凿组套

12 PCS
CrV
 CHISEL PRZECINAK 10x140 mm
 12x150 mm
 16x170 mm
 CENTER PUNCH PUNKTAK Ø6x100 mm
 Ø8x110 mm
 TAPER PUNCH WYBIJAK STOŻKOWY Ø2x140 mm
 PIN PUNCH WYBIJAK Ø4x150 mm
 Ø5x150 mm
 Ø1.5x150 mm
 Ø6x150 mm
 Ø3x150 mm
 Ø8x150 mm



PLASTIC HANGER

YATO **YT-4714** 10/20

- GB** Pin punch
D Splintentreiber
PL Wybijak
RUS Пробойник булавочный
CZ Vyrážeč
H Csapaszegkiütő

- RO** Dorn cilindric
F Percuteur
I Punzoni
E Punzón expulsador
CN 销式冲子

SLIDING CARD



150 mm
CrV 60
 PIN PUNCH WYBIJAK Ø3.8 mm



YATO **YT-4690** L (mm) 20/120
 150

- GB** Taper punch
D Durchtreiber
PL Dobijak stożkowy
RUS Пробойник конусный
CZ Průbojník
H Lyukasztó
RO Dorn conic

- F** Matoir
I Punzoni
E Retacador de cono
CN 冲孔器

SLIDING CARD



120 mm
CrV 60
 CENTER PUNCH WYBIJAK STOŻKOWY Ø3.3 mm



YATO **YT-4691** L (mm) 20/120
 120

- GB** Center punch
D Körner
PL Punktak
RUS Пробойник - керн
CZ Důlčák
H Pontozó

- RO** Punctator
F Pointeau
I Punzoni
E Retacador - punzón centrador
CN 冲子

SLIDING CARD



120 mm
CrV 60
 CENTER PUNCH PUNKTAK 3.8 mm



YATO **YT-4692** L (mm) 20/120
 120

- GB** Cold chisel
D Flach Meissel
PL Przecinak płaski
RUS Зубило плоское
CZ Sekáč plochý
H Laposvágó

- RO** Dalta lata
F Burin plat
I Scalpello piatto
E Tajadera en frío
CN 扁铲

SLIDING CARD



130 mm
CrV 60
 CHISEL PRZECINAK 12 mm



YATO **YT-4693** L (mm) 20/120
 130

- GB** Cape chisel
D Kreuzmeissel
PL Przecinak krzyżowy
RUS Зубило „пика”
CZ Sekáč křížový
H Keresztvágó
RO Dalta ascuțită

- F** Burin
I Scalpello rettangolare
E Tajadera rectangular
CN 钗头

SLIDING CARD



130 mm
CrV 60
 CAPE CHISEL PRZECINAK PROSTOKĄTNY 5.5 mm



YATO **YT-4694** L (mm) 20/120
 130

- GB** Chisel and punch set
D Trennmeissel- und Durchtreiber-Satz
PL Zestaw przecinaków i punktaków
RUS Зубила и керны в наборе
CZ Sekáče a průbojníky
H Véső és lyukasztó készlet
RO Set dalti de impact
F Set de burins
I Set scalpelli e bulino
E Juego de cinceles de acero templado y punzones
CN 样冲组套

SLIDING CARD



5 PCS
CrV 60
 CHISEL PRZECINAK 12x130 mm
 PIN PUNCH WYBIJAK Ø3.8x150 mm
 CENTER PUNCH PUNKTAK 3.8x120 mm
 TAPER PUNCH WYBIJAK STOŻKOWY Ø3.3 mm
 CAPE CHISEL PRZECINAK PROSTOKĄTNY 5.5x130 mm



YATO **YT-4695** 6/24

GB Hexagonal wrecking bar
D Brechstange
PL Łom sześciokątny
RUS Лом-гвоздодёр шестигранный
CZ Šestiúhlé páčidlo
H Hatszögű feszítővas
RO Ranga pt. scos cuie
F Pied-de-biche manche hexagonal
I Mazza di ferro
E Palanqueta
CN 撬棒

DROP FORGED KUTE



YATO	size / rozmiar (mm)	
YT-46800	400x18	6/12
YT-46801	450x18	6/12
YT-46802	600x18	6/12
YT-46803	750x18	6/12
YT-46804	900x18	5/10

GB Hexagonal wrecking bar
D Brechstange
PL Łom sześciokątny
RUS Лом-гвоздодёр шестигранный
CZ Šestiúhlé páčidlo
H Hatszögű feszítővas
RO Ranga pt. scos cuie
F Pied-de-biche manche hexagonal
I Mazza di ferro
E Palanqueta
CN 撬棒

DROP FORGED KUTE



YATO	size / rozmiar (mm)	
YT-46831	400x16	6/24
YT-46832	600x20	6/12
YT-46833	800x22	6/12
YT-46834	1000x22	6
YT-46835	1200x25	6
YT-46836	1500x25	6

GB Profiled wrecking bar
D Nageleisen
PL Łom profilowany
RUS Лом-гвоздодёр
CZ Páčidlo
H Szögkihúzó
RO Ranga pt. scos cuie
F Pied-de-biche profilé
I Mazza di ferro
E Palanqueta
CN 撬棒

DROP FORGED KUTE



YATO	size / rozmiar (mm)	
YT-46810	350x22x13	6/12
YT-46811	450x30x17	6/12
YT-46812	600x30x17	4/8
YT-46813	750x30x17	4/8
YT-46814	900x30x17	3/6

GB Flat wrecking bar
D Nageleisen spitze
PL Łom płaski
RUS Лом плоский
CZ Páčidlo ploché
H Lapos feszítővas
RO Ranga plata
F Pied-de-biche plat
I Mazza di ferro
E Palanqueta
CN 撬棒

DROP FORGED KUTE



YATO	size / rozmiar (mm)	
YT-46820	300x35x6	10/30
YT-46821	380x35x6	10/20
YT-46822	450x35x6	10/20
YT-46823	600x35x6	10/20

8

GB Go-through pry bar set
D Nageleisensatz
PL Zestaw łomów

RUS Набор ломов
CZ Sada mini páčidel
H Szöghúzó készlet

RO Set leviere
F Set de pieds-de-biche
I Set mazza di ferro

E Juego de palancas de hierro
CN 穿心撬棒组套

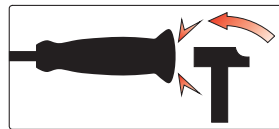

4 PCS



- 198x6x6 mm, 110 g
- 304x10x10 mm, 292 g
- 456x10x10 mm, 479 g
- 608x12x12 mm, 745 g

DOUBLE BLISTER

YATO	
YT-4730	3/6

GB Axe
D Beil
PL Siekiera

RUS Топор
CZ Sekerka
H Szekerce

RO Secure
F Hache
I Ascia

E Hacha
CN 把斧



Genuine hickory shaft
Trzonek z hickory

Timber wedge and steel ring
Drewniany klin ze stalowym pierścieniem

Forged carbon steel head hardened and tempered
Głowica z kutej stali węglowej, hartowana i utwardzona

DIN 5131
7294

YATO	m (g)	L (mm)	DIN	
YT-8001	600	360	5131	24
YT-8002	800	380	5131	20
YT-8003	1000	430	5131	12
YT-8004	1250	710	7294	12
YT-8005	1400	710	7294	12
YT-8006	1600	810	7294	12



Genuine hickory shaft
Trzonek z hickory

Timber wedge and steel ring
Drewniany klin ze stalowym pierścieniem

Forged carbon steel head hardened and tempered
Głowica z kutej stali węglowej, hartowana i utwardzona

YATO	m (g)	L (mm)	
YT-8011	1000	515	6
YT-8012	2000	820	6

GB Adze flat type
D Flachdaxel
PL Ciosło płaskie
RUS Тесло плоское
CZ Sekyrka
H Szekerce

RO Tesla
F Hache d'artisans
I Ascia tipo piatto
E Destral de artesanos
CN 扁斧



YATO	
YT-80130	4/24

Memo

9

Clamps, vices & holders Ściski, imadła i wsporniki



Clamps
Ściski

140-141



Magnetic holders
Wsporniki magnetyczne

142



Vices
Imadła

141



- GB** F-clamp
D Schraubzwinde
PL Ścisk stolarski
RUS Струбцина
CZ Truhlářské upínadlo
H Asztalos szorító
RO Menghină pt. tâmplărie
F Presse à serrage pour menuisier
I Morsetto da falegname
E Tornillo de apriete
CN F夹钳



QUICK ADJUSTMENT SZYBKĄ REGULACJĄ

QUICK ADJUSTMENT SZYBKĄ REGULACJĄ

YATO	L (mm)	
YT-6401	160x80	10/30
YT-6402	200x80	10/30
YT-6403	250x80	10/30
YT-6404	300x80	10/30
YT-6405	450x80	10/20
YT-6406	600x80	10/20
YT-6407	400x120	10
YT-6408	500x120	10
YT-6409	600x120	10
YT-6410	900x120	5

YATO	L (mm)	
YT-64111	250x80	4/24
YT-64112	300x80	4/24
YT-64113	450x80	4/24
YT-6412	300x120	10
YT-6413	400x120	10
YT-6414	500x120	5
YT-6415	600x120	5
YT-6416	900x120	5
YT-6417	1050x120	5

YATO	L (mm)	
YT-6440	100x50	12/60
YT-6441	150x50	12/48
YT-6442	200x50	12/48
YT-6443	250x50	12/48
YT-6444	300x50	12/48
YT-6445	200x80	10/20
YT-6446	250x80	10/20
YT-6447	300x80	10/20
YT-6448	500x80	10/20
YT-6449	300x120	10
YT-6450	500x120	10
YT-6451	800x120	6
YT-6452	1000x120	6
YT-6453	1200x120	6
YT-6454	1500x120	6

- GB** Bar clamp ratchet
D Lenkerklemmung Ratsche
PL Ścisk stolarski zapadkowy
RUS Струбцина быстросфиксируемая
CZ Svěrka s ráčnou
H Bár bilincs racsnis
RO Presă tip „F” cu clichet
F Bar pince à cliquet
I Bar morsetto a cricchetto
E Barra de mordaza de trinquete
CN 棘轮F夹



- GB** Spring clamp
D Federklemme
PL Ścisk sprężynowy
RUS Струбцина пружинová
CZ Pružinové upínadlo
H Rugós szorító
RO Cleste presa pt. lemn
F Pince de serrage
I Morsetto a molla
E Pinza
CN 弹簧夹



YATO	L (mm)	max. jaws range / max. zasięg szczęk (mm)	max. jaws depth / max. głębokość szczęk (mm)	
YT-64270	100	42	44	24/240
YT-64271	150	55	68	12/120
YT-64272	200	79	91	10/100

- GB** Insulated spring clamp
D Federklemme vollisoliert
PL Ścisk sprężynowy izolowany
RUS Струбцина изолированная
CZ Pružinové upínadlo izolované
H Rugós szorító
RO Cleste presa pt. lemn izolat
F Pince de serrage isolée
I Pinze di bloccaggio isolate
E Pinza aislante
CN 绝缘弹簧夹



150 mm

CrV

1000 V

D'E

POLYBAG



1000V VDE CERTIFICATE EN 60900:2012

YATO	L (mm)	
YT-63951	200x100	2/12
YT-63952	250x100	2/12
YT-63953	300x100	2/12
YT-63954	400x100	2/6
YT-63955	500x120	2/4
YT-63956	600x120	2/4
YT-63957	800x120	2/4
YT-63958	1000x120	2

YATO	working capacity / zakres pracy (mm)	L (mm)	
YT-21190	2-20	150	5/40

- GB C-Clamp
D C-Schraubzwinge
PL Ścisk typu „C”
RUS Струбцина типа „С”
- CZ Svěrka tvaru „C”
H Pillanatszorító
RO Menghină tip „C”
F Serre-joint
- I Morsetto tipo „C”
E Tornillo tipo „C”
CN 深喉型C型夹



DROP FORGED KUTE

YATO	size / rozmiar (mm)	force pressure / siła nacisku (kg)	
YT-6420	50	1500	6/30
YT-6421	75	1950	6/18
YT-6422	100	2980	6/12
YT-6423	150	3200	6/12
YT-6424	200	3600	6

YATO	size / rozmiar (mm)	force pressure / siła nacisku (kg)	
YT-64250	25	120	100
YT-64251	50	200	50
YT-64252	75	280	30
YT-64253	100	350	30
YT-64254	125	390	18
YT-64255	150	450	12
YT-64256	200	500	10
YT-64257	250	540	5
YT-64258	300	600	5

- GB Swivel base bench vice
D Drehbare Schraubstock
PL Imadło ślusarskie obrotowe
RUS Тиски слесарные поворотные
CZ Zámečnický svěrák otáčivě
H Satu, lakatos forgó
RO Menghină rotativă
F Étau rotatif de serrurier
I Morsa a cerniera
E Tornillo de apriete giratorio
CN 台虎钳

COLOR BOX



- anvil and changeable jaws made of hardened steel
- kowadełko i wymienne szczęki z hartowanej stali

YATO	jaws width / szerokość szczęk (mm)	weight / waga (kg)	
YT-6501	100	7	2
YT-6502	125	10	2
YT-6503	150	15	1
YT-65048	150	19	1
YT-6504	200	21	1
YT-65049	200	29.5	1

- GB Swivel base bench vice
D Drehbare Schraubstock
PL Imadło ślusarskie obrotowe
RUS Тиски слесарные поворотные
CZ Zámečnický svěrák otáčivě
H Satu, lakatos forgó
RO Menghină rotativă
F Étau rotatif de serrurier
I Morsa a cerniera
E Tornillo de apriete giratorio
CN 台虎钳

COLOR BOX

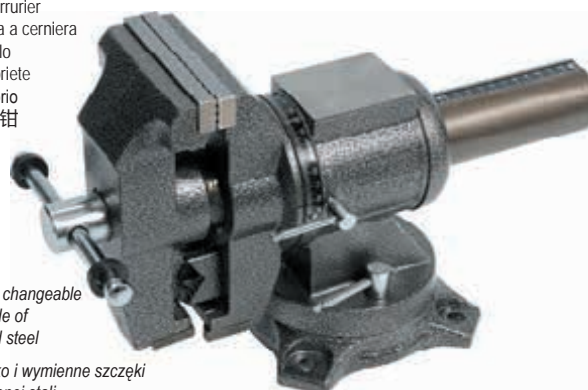

- anvil and changeable jaws made of hardened steel
- kowadełko i wymienne szczęki z hartowanej stali

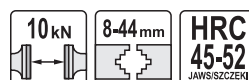

YATO	jaws width / szerokość szczęk (mm)	jaws range / rozstaw szczęk (mm)	weight / waga (kg)	
YT-6505	100	100	10	1

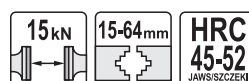

YATO	jaws width / szerokość szczęk (mm)	jaws range / rozstaw szczęk (mm)	weight / waga (kg)	
YT-6506	125	125	20	1

- GB Hinged pipe vice
D Rohrschraubstock
PL Imadło zaciskowe do rur
RUS Тиски для труб
CZ Upinací svěrák na trubky
H Satu, csőszorító
RO Menghină pt. țevi
F Étau de serrage à tuyaux
I Morsa stringi tubo
E Tornillo de apriete para tubos
CN 管子台虎钳



S55C

COLOR BOX



YATO	Ø (mm)	
YT-6510	60	4
YT-6511	76	2
YT-6512	90	2
YT-6513	110	1

- GB** Adjustable angle welding magnet
D Verstellbarer Magnet-Werkstückhalter
PL Wspornik magnetyczny spawalniczy regulowany
RUS Регулируемый магнит заварки угла
CZ Polohovací magnetický držák ke svařování
H Állítható, mágneses, hegesztő támasz
RO Dispozitiv magnetic reglabil pt. sudura
F Support magnétique de soudure
I Supporto della saldatura magnetico
E Soporte magnético de soldadura, ajustable
CN 焊接磁铁



DOUBLE BLISTER



YATO 	⚖️ (kg)	mm	📦
YT-0862	2x22.5	85x65x22	6

- GB** Magnetic welding holder
D Magnet-Werkstückhalter
PL Kątownik magnetyczny spawalniczy
RUS Магнитная струбина заварки

- CZ** Magnetický uhelník ke svařování
H Mágneses, hegesztő szögvas
RO Dispozitiv magnetic fixare pt. sudura
F Support magnétique de soudure

- I** Angolo magnetico da saldatura
E Escuadra magnética de soldadura
CN 焊接磁铁

DOUBLE BLISTER



YATO 	⚖️ (kg)	mm	📦
YT-0863	11.5	82x120x13	6/48

YATO 	⚖️ (kg)	∅ (mm)	mm	📦
YT-0864	22.5	18	102x155x17	6/30
YT-0865	34.0	46	122x190x25	6/18

- GB** Magnetic welding holder
D Magnet-Werkstückhalter
PL Kątownik magnetyczny spawalniczy
RUS Магнитная струбина заварки

- CZ** Magnetický uhelník ke svařování
H Mágneses, hegesztő szögvas
RO Dispozitiv magnetic fixare pt. sudura
F Support magnétique de soudure

- I** Triangolo magnetico da saldatura con interruttore
E Escuadra magnética de soldadura con interruptor
CN 焊接磁铁



DOUBLE BLISTER



YATO 	⚖️ (kg)	mm	📦
YT-0866	11.5	64x95x14	6/24
YT-0867	34.0	111x136x24	6/18

- GB** Magnetic welding holder with switch
D Magnet-Werkstückhalter mit Schalter
PL Kątownik magnetyczny spawalniczy z wyłącznikiem
RUS Магнитный держатель заварки с выключателем

- CZ** Magnetický uhelník ke svařování s vypínačem
H Mágneses, hegesztő szögvas, kapcsolóval
RO Dispozitiv magnetic fixare pt. sudura cu intreruptor
F Support magnétique de soudure

- I** Triangolo magnetico da saldatura con interruttore
E Escuadra magnética de soldadura, con interruptor
CN 焊接磁铁

DOUBLE BLISTER



YATO 	⚖️ (kg)	mm	📦
YT-0870	13.5	107x160x26	6/24

Memo

10

Cutting tools Narzędzia tnące





Drills Wiertła	
.....	147-153

Twist drill bits HSS & sets Wiertła do metalu HSS i zestawy.....	147
Twist drill bits HSS-E Co & sets Wiertła do metalu HSS-E Co i zestawy.....	147
Twist drill bits HSS-TiN & sets Wiertła do metalu HSS-TiN i zestawy.....	148
SDS masonry drill bits X-TIP Wiertła do betonu SDS, z grotem krzyżowym.....	149
SDS masonry drill bits Wiertła do betonu SDS.....	150
Masonry drill bits with cylindrical shank & sets Wiertła do betonu z uchwytem cylindrycznym i zestawy.....	150
Flat wood drill bits & sets Wiertła łopatkowe do drewna i zestawy.....	151
Spur wood drill bits Wiertła do drewna spiralne.....	152
Auger wood drill bits & sets Świdry do drewna i zestawy.....	152
Drills for ceramic tiles Wiertła do ceramiki i gresu.....	153

Adjustable hand reamers Rozwiertaki nastawne	
.....	153

Spot weld cutter sets Zestawy rozwiertaków do zgrzewów	
.....	153

Combination edge setters & hole punch pliers Dziurkarko-felcarki	
.....	153

SDS Chisels Przecinak i dłuta SDS	
.....	154

Hollow drill sets Wiertła koronowe do betonu	
.....	154

Bi-metal hole saws Otwornice bimetalowe	
.....	154-155

Bi-metal hole saws Otwornice bimetalowe.....	154
Arbors for hole saws Uchwyty do otwornic bimetalowych.....	155
Hole saw kits Zestawy otwornic bimetalowych.....	155

Taps & dies Narzędzia do gwintowania	
.....	156-158

Hand taps & sets Gwintowniki i zestawy.....	156
Circular dies Narzynki.....	157
Step drills Wiertła stopniowe.....	157

Tap wrenches & die holders Pokręta do gwintowników i narzynek.....	157
Thread repair sets & accessories Zestawy do naprawy gwintów i akcesoria.....	158

Router bits Frezy do drewna	
.....	159

Diamond tools Narzędzia diamentowe	
.....	160

Diamond blades for cutting construction materials Tarcze diamentowe do cięcia materiałów budowlanych.....	160
Diamond grinding cup wheels Diamentowe talerze szlifierskie do betonu i kamienia.....	160
Diamond core drill bits Diamentowe wiertła koronowe.....	160

Tungsten carbide tipped tools Narzędzia z ostrzem z węgliku wolframu	
.....	161

Tungsten carbide saws for wood Tarcze z węglikiem do drewna.....	161
Tungsten carbide saws for aluminium Tarcze z węglikiem do aluminium.....	161

Cutting & grinding discs Tarcze do cięcia i szlifowania	
.....	162-163

Stainless steel cutting discs Tarcze do cięcia stali nierdzewnej.....	162
Metal cutting discs Tarcze do cięcia metalu.....	162
Metal grinding discs Tarcze do szlifowania metalu.....	162
Stone cutting discs Tarcze do cięcia kamienia.....	162
Stone grinding discs Tarcze do szlifowania kamienia.....	162
Cutting & grinding rasp discs Tarcze tarczowe do cięcia i szlifowania.....	163

Shears Nożyce	
.....	164-168

Heavy duty cable cutters Nożyce do cięcia przewodów.....	164
Tin snips Nożyce do blachy.....	164
Steel strap cutters Nożyce do cięcia taśm stalowych.....	167
Bolt cutters Nożyce do prętów.....	167
Hydraulic cutters & accessories Nożyce z siłownikiem hydraulicznym i akcesoria.....	168
Cable cutters Nożyce do kabli.....	168
Multifunctional scissors Nożyce wielofunkcyjne.....	168



Saws & blades
Piły i brzeszczoty

169-174



Hand saws	
Piły do drewna.....	169
Bow saws	
Piły kabłąkowe.....	170
Blades	
Brzeszczoty.....	170
Hacksaw frames	
Piły do metalu.....	170
Hacksaw frame blades	
Brzeszczoty do metalu.....	170
Jig saw blades	
Brzeszczoty do wyrzynarek.....	171
Accessories for multi-purpose oscillating tools	
Akcesoria do wielofunkcyjnych narzędzi oscylacyjnych.....	172

Profile gauges	
Wzorniki profili.....	182
Punch sets	
Przebijaki do skóry.....	182
Cutters	
Obcinaki.....	183
Window scrapers	
Skrobaki do szyb.....	185
Scrapers	
Cykliny metalowe.....	185
Steel files & sets	
Pilniki do metalu i zestawy.....	185
Needle file sets	
Zestawy pilników iglaków.....	186
Diamond needle files & sets	
Pilniki iglaki diamentowe i zestawy.....	187
Rasps & sets	
Tarniki do drewna i zestawy.....	189
Rasps for plaster	
Tarniki do gipsu.....	189

Brushes, knives & files
Szczotki, noże i pilniki

175-189



Wire brushes & sets	
Szczotki druciane i zestawy.....	175
Cleaning pads for pipes	
Włókniny do czyszczenia rur.....	176
Cup brushes	
Szczotki tarczowe.....	176
Knives & blades	
Noże i ostrza.....	177
Scissors	
Nożyczki.....	181
Marking out tools	
Narzędzia traserskie.....	181

Abrasive products
Artykuły ścierne

190-194



Sand papers	
Papiery ścierne.....	190
Waterproof sand papers	
Papiery ścierne wodoodporne.....	191
Abrasive clothes	
Płótna ścierne.....	191
No end abrasive bands	
Taśmy ścierne bezkońcowe.....	192
Flap discs	
Ściernice listkowe.....	193
Abrasive sheets and discs	
Arkusze i krążki ścierne.....	194

GB Twist drill HSS
D Metallschraubbohrer HSS
PL Wiertło do metalu HSS
RUS Сверло по металлу HSS
CZ Vrták na kov HSS
H Fúrószár fémhez HSS
RO Burghiu pt. metal HSS
F Foret métal HSS
I Punta per metallo HSS
E Broca para metal HSS
CN 轧制麻花钻

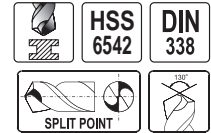
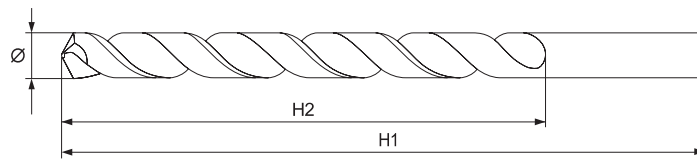

• application: industry
• for precise drilling in steels, cast steels, non-ferrous metals, plastics

• przeznaczenie: przemysł
• do precyzyjnych wierceń w stalach, żeliwach, metalach nieżelaznych, tworzywach sztucznych

YATO	Ø (mm)	H1 (mm)	H2 (mm)	R.P.M.max.	PCS packing:	Box
YT-4430	1.0	34	12	3800	10	80/320
YT-4431	1.5	43	20	3800	10	80/320
YT-4432	2.0	49	24	4000	10	80/320
YT-4433	2.5	57	30	3200	10	80/320
YT-4434	2.8	61	33	2800	10	80/320
YT-4435	3.0	61	33	2600	10	80/320
YT-4436	3.2	65	36	2500	10	80/320
YT-4437	3.5	70	39	2300	10	80/320
YT-4438	4.0	75	43	2000	10	80/320
YT-4439	4.2	75	43	1900	10	20/80

YATO	Ø (mm)	H1 (mm)	H2 (mm)	R.P.M.max.	PCS packing:	Box
YT-4440	4.5	80	47	1800	10	20/80
YT-4441	4.8	86	52	1600	10	20/80
YT-4442	5.0	86	52	1600	10	20/80
YT-4443	5.2	86	52	1500	10	20/80
YT-4444	5.5	93	57	1500	10	20/80
YT-4445	6.0	93	57	1300	10	20/80
YT-4446	6.5	101	63	1200	10	10/40
YT-4447	7.0	109	69	1100	10	10/40
YT-4448	7.5	109	69	1100	10	10/40
YT-4449	8.0	117	75	1000	10	10/40

YATO	Ø (mm)	H1 (mm)	H2 (mm)	R.P.M.max.	PCS packing:	Box
YT-4450	8.5	117	75	900	5	10/40
YT-4451	9.0	125	81	900	5	10/40
YT-4452	9.5	125	81	800	5	10/40
YT-4453	10.0	133	87	800	5	10/40
YT-4454	10.5	133	87	800	3	10/40
YT-4455	11.0	142	94	700	3	10/40
YT-4456	12.0	151	101	700	3	10/40
YT-4457	12.5	151	101	600	3	10/40
YT-4458	13.0	151	101	600	3	10/40

GB Twist drill set
D Metallschraubbohrersatz
PL Komplet wiertel do metalu

RUS Набор сверл по металлу
CZ Souprava vrtáků na kov
H Fúrószárkészlet fémhez

RO Set de burghie pt. metal
F Set des forets métal HSS
I Set punte per metallo

E Broca para metal
CN 轧制麻花钻组套



PLASTIC HANGING BOX



6 PCS
Ø mm 2-8

10 PCS
Ø mm 1-10



PLASTIC HANGING BOX



19 PCS
Ø mm 1-10

YATO	Ø (mm)	Box
YT-4460	2; 3; 4; 5; 6; 8	15/60
YT-4461	1; 2; 3; 4; 5; 6; 7; 8; 9; 10	20/40

GB Twist drill HSS-COBALT
D Metallschraubbohrer HSS-COBALT
PL Wiertło do metalu HSS-COBALT
RUS Сверло по металлу HSS-COBALT
CZ Vrták na kov HSS-COBALT
H Fúrószár fémhez HSS-COBALT
RO Burghiu pt. metal HSS-COBALT
F Foret métal HSS -COBALT
I Punta per metallo HSS -COBALT
E Broca para metal HSS-COBALT
CN 全磨制含钴麻花钻

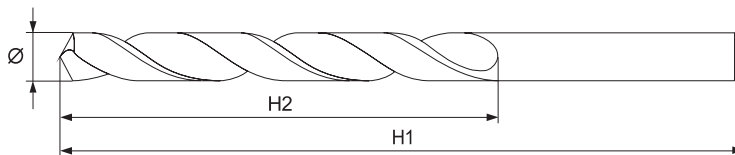

• application: industry
• for precise drilling in hard steels, non-ferrous metals, plastics, stainless steel and acid resistant steel
• resistant to high temperatures

• przeznaczenie: przemysł
• do precyzyjnych wierceń w trudnych materiałach, np. stalach szlachetnych, metalach kolorowych, tworzywach, stalach nierdzewnych i kwasoodpornych
• odporne na działanie wysokiej temperatury

YATO	Ø (mm)	H1 (mm)	H2 (mm)	PCS packing:	Box
YT-4020	2.0	49	24	2	125/500
YT-4025	2.5	57	30	2	125/500
YT-4030	3.0	61	33	2	125/500
YT-4032	3.2	65	36	1	100/400
YT-4035	3.5	70	39	1	100/400
YT-4040	4.0	75	43	1	100/400
YT-4042	4.2	75	43	1	100/400
YT-4045	4.5	80	47	1	100/400

YATO	Ø (mm)	H1 (mm)	H2 (mm)	PCS packing:	Box
YT-4048	4.8	86	52	1	100/400
YT-4050	5.0	86	52	1	100/400
YT-4052	5.2	86	52	1	100/400
YT-4055	5.5	93	57	1	100/400
YT-4060	6.0	93	57	1	100/400
YT-4065	6.5	101	63	1	75/300
YT-4070	7.0	109	69	1	75/300
YT-4075	7.5	109	69	1	75/300

YATO	Ø (mm)	H1 (mm)	H2 (mm)	PCS packing:	Box
YT-4080	8.0	117	75	1	75/300
YT-4085	8.5	117	75	1	75/300
YT-4090	9.0	125	81	1	75/300
YT-4100	10.0	133	87	1	75/300
YT-4110	11.0	142	94	1	75/300
YT-4120	12.0	151	101	1	75/300
YT-4140	14.0	160	108	1	25/100
YT-4160	16.0	178	120	1	25/100

GB Twist drill set
 D Metallspiralbohrersatz
 PL Komplet wiertel do metalu
 RUS Набор сверл по металлу

CZ Souprava vrtáků na kov
 H Fúrószárkészlet fémhez
 RO Set de burghie pt. metal
 F Set des forets métal HSS

I Set punte per metallo
 E Broca para metal
 CN 轧制麻花钻组套



DIN 338

HSS-E Co HS6-5-2-5
 (PN-EN ISO 4957:2002(U))

Rm
 >900 N/mm²



6 PCS
 Ø mm
2-8

PLASTIC HANGING BOX

10 PCS
 Ø mm
1-10

PLASTIC HANGING BOX

YATO	Ø (mm)	
YT-41602	2; 3; 4; 5; 6; 8	15/60

YATO	Ø (mm)	
YT-41603	1; 2; 3; 4; 5; 6; 7; 8; 9; 10	20/40

19 PCS
 Ø mm
1-10

PLASTIC HANGING BOX

25 PCS
 Ø mm
1-13

PLASTIC HANGING BOX

YATO	Ø (mm)	
YT-41604	1.0; 1.5; 2.0; 2.5; 3.0; 3.5; 4.0; 4.5; 5.0; 5.5; 6.0; 6.5; 7.0; 7.5; 8.0; 8.5; 9.0; 9.5; 10.0	15/30

YATO	Ø (mm)	
YT-41605	1.0; 1.5; 2.0; 2.5; 3.0; 3.5; 4.0; 4.5; 5.0; 5.5; 6.0; 6.5; 7.0; 7.5; 8.0; 8.5; 9.0; 9.5; 10.0; 10.5; 11.0; 11.5; 12.0; 12.5; 13.0	10

GB Twist drill
 D Metallspiralbohrer
 PL Wiertło do metalu
 RUS Сверло по металлу
 CZ Vrták na kov
 H Fúrószár fémhez
 RO Burghiu pt. metal
 F Foret métal
 I Punte per metallo
 E Broca para metal
 CN 全磨制含钴麻花钻

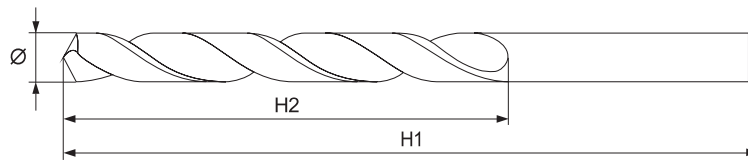

DIN 338



HSS

BLISTER CARD

YATO	Ø (mm)	H1 (mm)	H2 (mm)	PCS packing:	
YT-44630	1.0	34	12	2	50/500
YT-44631	1.5	40	18	2	50/500
YT-44632	2.0	49	24	2	50/500
YT-44633	2.5	57	30	2	50/500
YT-44634	2.8	61	33	2	50/500
YT-44635	3.0	61	33	2	50/500
YT-44637	3.2	65	36	1	50/500
YT-44639	3.5	70	39	1	50/500
YT-44640	4.0	75	43	1	50/500
YT-44642	4.2	75	43	1	50/500

YATO	Ø (mm)	H1 (mm)	H2 (mm)	PCS packing:	
YT-44643	4.5	80	47	1	50/500
YT-44645	4.8	86	52	1	50/500
YT-44650	5.0	86	52	1	50/500
YT-44652	5.2	86	52	1	50/500
YT-44653	5.5	93	57	1	50/500
YT-44654	6.0	93	57	1	50/500
YT-44655	6.5	101	63	1	50/250
YT-44656	7.0	109	69	1	50/250
YT-44657	7.5	109	69	1	50/250
YT-44658	8.0	117	75	1	50/250

YATO	Ø (mm)	H1 (mm)	H2 (mm)	PCS packing:	
YT-44659	8.5	117	75	1	50/250
YT-44660	9.0	125	81	1	50/250
YT-44661	9.5	125	81	1	50/250
YT-44662	10.0	133	87	1	50/200
YT-44663	10.5	133	87	1	50/200
YT-44664	11.0	142	94	1	50/200
YT-44666	12.0	151	101	1	50/100
YT-44667	12.5	151	101	1	50/100
YT-44668	13.0	151	101	1	50/100

GB Twist drill
 D Metallspiralbohrer
 PL Wiertło do metalu
 RUS Сверло по металлу
 CZ Vrták na kov
 H Fúrószár fémhez
 RO Burghiu pt. metal
 F Foret métal
 I Punte per metallo
 E Broca para metal
 CN 全磨制含钴麻花钻

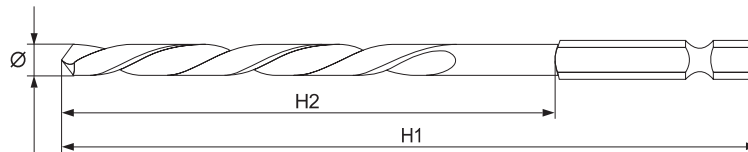

DIN 338

HSS 4241
 1/4"
 6.3 mm

BLISTER CARD

YATO	Ø (mm)	H1 (mm)	H2 (mm)	PCS packing:	
YT-44750	1.5	63	18	1	150/600
YT-44751	2.0	72	24	1	150/600
YT-44752	2.5	80	30	1	150/600
YT-44754	3.0	81	33	1	150/600
YT-44755	3.2	85	36	1	150/600
YT-44756	3.5	90	39	1	150/600
YT-44757	4.0	95	43	1	150/600
YT-44758	4.2	95	43	1	150/600

YATO	Ø (mm)	H1 (mm)	H2 (mm)	PCS packing:	
YT-44759	4.5	100	47	1	150/600
YT-44760	4.8	106	52	1	100/400
YT-44761	5.0	106	52	1	100/400
YT-44763	5.5	113	57	1	100/400
YT-44764	6.0	113	57	1	100/400
YT-44765	6.5	121	63	1	100/400
YT-44766	7.0	109	69	1	100/400
YT-44767	7.5	109	69	1	100/400

YATO	Ø (mm)	H1 (mm)	H2 (mm)	PCS packing:	
YT-44768	8.0	117	75	1	100/400
YT-44769	8.5	117	75	1	100/400
YT-44770	9.0	125	81	1	50/200
YT-44772	10.0	133	87	1	50/200
YT-44773	11.0	142	94	1	50/200
YT-44774	12.0	151	101	1	50/200
YT-44776	13.0	151	101	1	50/200

GB Twist drill set
D Metallschraubbohrersatz
PL Komplet wiertel do metalu
RUS Набор сверл по металлу
CZ Souprava vrtáků na kov
H Fúrószárkészlet fémhez

RO Set de burghie pt. metal
F Set des forets métal HSS
I Set punte per metallo
E Broca para metal
CN 轧制麻花钻组套



YATO	Ø (mm)	
YT-44700	4; 5; 6; 8; 10	30/60

GB Twist drill set
D Metallschraubbohrersatz
PL Komplet wiertel do metalu
RUS Набор сверл по металлу
CZ Souprava vrtáků na kov
H Fúrószárkészlet fémhez
RO Set de burghie pt. metal

F Set des forets métal HSS
I Set punte per metallo
E Broca para metal
CN 轧制麻花钻组套

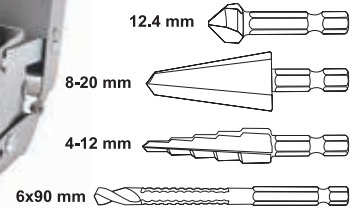
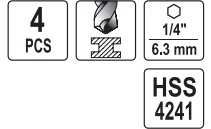

YATO		
YT-44705		12/24

METAL BOX & SLIDING CARD

GB Twist drill set
D Metallschraubbohrersatz
PL Komplet wiertel do metalu
RUS Набор сверл по металлу

CZ Souprava vrtáků na kov
H Fúrószárkészlet fémhez
RO Set de burghie pt. metal
F Set des forets métal HSS

I Set punte per metallo
E Broca para metal
CN 轧制麻花钻组套

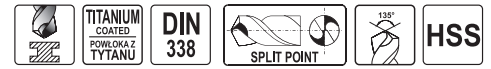

6 PCS
Ø mm 2-8

PLASTIC HANGING BOX

YATO	Ø (mm)	
YT-44673	2; 3; 4; 5; 6; 8	50/100



10 PCS
Ø mm 1-10

PLASTIC HANGING BOX

YATO	Ø (mm)	
YT-44674	1; 2; 3; 4; 5; 6; 7; 8; 9; 10	25/100



19 PCS
Ø mm 1-10

PLASTIC HANGING BOX

YATO	Ø (mm)	
YT-44675	1.0; 1.5; 2.0; 2.5; 3.0; 3.5; 4.0; 4.5; 5.0; 5.5; 6.0; 6.5; 7.0; 7.5; 8.0; 8.5; 9.0; 9.5; 10.0	6/30



25 PCS
Ø mm 1-13

PLASTIC HANGING BOX

YATO	Ø (mm)	
YT-44676	1.0; 1.5; 2.0; 2.5; 3.0; 3.5; 4.0; 4.5; 5.0; 5.5; 6.0; 6.5; 7.0; 7.5; 8.0; 8.5; 9.0; 9.5; 10.0; 10.5; 11.0; 11.5; 12.0; 12.5; 13.0	5/10

GB Masonry drill bit X-TIP
D Betonspiralbohrer X-TIP
PL Wiertło do betonu X-TIP
RUS Сверло по бетону X-TIP
CZ Vrták na beton X-TIP
H Fúrószár betonhoz X-TIP
RO Burghiu pt. beton X-TIP
F Foret béton à pointe en croix
I Punta per cemento X-TIP
E Broca para hormigón X-TIP
CN 十字头电锤钻

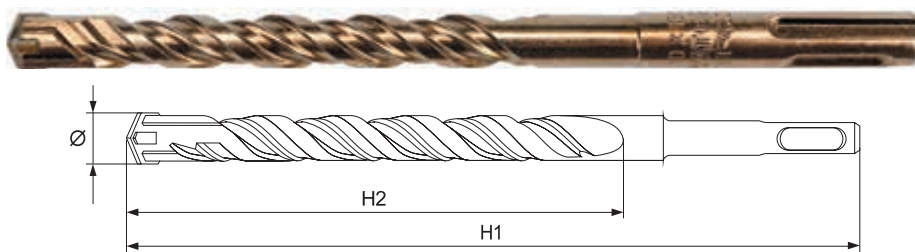

PLASTIC HANGER

YATO	Ø (mm)	H1 (mm)	H2 (mm)	PCS packing	
YT-4200	5	110	45	10	300
YT-4201	6	110	45	10	300
YT-4202	6	160	95	10	200
YT-4203	6	210	135	10	150
YT-4204	8	110	45	10	300
YT-4205	8	160	95	10	200
YT-4206	8	210	140	10	150
YT-4207	8	460	370	10	50
YT-4208	8	600	500	10	50
YT-4209	10	160	95	10	150
YT-4210	10	210	140	10	150

YATO	Ø (mm)	H1 (mm)	H2 (mm)	PCS packing	
YT-4211	10	300	220	10	100
YT-4212	10	460	370	10	50
YT-4213	10	600	500	10	50
YT-4214	12	160	95	10	150
YT-4215	12	260	185	10	100
YT-4216	12	460	360	10	50
YT-4217	12	600	490	10	40
YT-4218	14	260	180	10	80
YT-4219	14	460	360	10	40
YT-4220	16	200	125	10	60
YT-4221	16	460	360	10	20

YATO	Ø (mm)	H1 (mm)	H2 (mm)	PCS packing	
YT-4222	16	600	490	10	20
YT-4223	18	460	360	10	20
YT-4224	18	600	490	10	20
YT-4225	20	460	360	5	20
YT-4226	20	600	490	5	20
YT-4227	22	460	360	5	20
YT-4228	22	600	490	5	20
YT-4229	25	460	360	5	20
YT-4230	25	600	490	5	10

- GB Masonry drill bit
- D Betonspiralbohrer
- PL Wiertło do betonu
- RUS Сверло по бетону
- CZ Vrták na beton
- H Fúrészár betonhoz
- RO Burghiu pt. beton
- F Foret béton
- I Punta per cemento
- E Broca para hormigón
- CN 建工钻

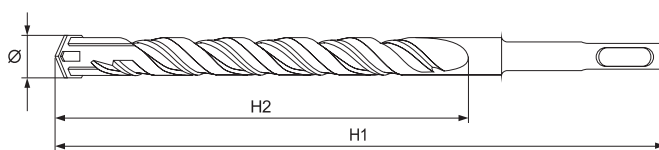

PLASTIC HANGER



YATO	Ø (mm)	H1 (mm)	H2 (mm)	PCS packing:	
YT-4161	5	110	45	10	300
YT-4162	6	110	45	10	300
YT-4163	6	160	95	10	200
YT-4164	6	210	140	10	150
YT-4165	8	110	45	10	300
YT-4166	8	160	90	10	200
YT-4167	8	210	140	10	150
YT-4168	8	460	370	10	50
YT-4169	8	600	500	10	50
YT-4170	10	160	95	10	150
YT-4171	10	210	140	10	150

YATO	Ø (mm)	H1 (mm)	H2 (mm)	PCS packing:	
YT-4172	10	300	220	10	100
YT-4173	10	460	370	10	50
YT-4174	10	600	500	10	50
YT-4175	12	160	85	10	150
YT-4176	12	260	180	10	100
YT-4177	12	460	360	10	50
YT-4178	12	600	490	10	40
YT-4179	14	260	180	10	80
YT-4180	14	460	360	10	40
YT-4181	16	200	125	10	60
YT-4182	16	300	220	10	50

YATO	Ø (mm)	H1 (mm)	H2 (mm)	PCS packing:	
YT-4183	16	460	360	10	20
YT-4184	16	600	490	10	20
YT-4185	18	460	360	10	20
YT-4186	18	600	490	10	20
YT-4187	20	460	360	5	20
YT-4188	20	600	490	5	20
YT-4189	22	460	360	5	20
YT-4190	22	600	490	5	20
YT-4191	25	460	360	5	20
YT-4192	25	600	490	5	10

- GB Masonry drill bit
- D Betonspiralbohrer
- PL Wiertło do betonu
- RUS Сверло по бетону
- CZ Vrták na beton
- H Fúrészár betonhoz
- RO Burghiu pt. beton
- F Foret béton
- I Punta per cemento
- E Broca para hormigón
- CN 建工钻

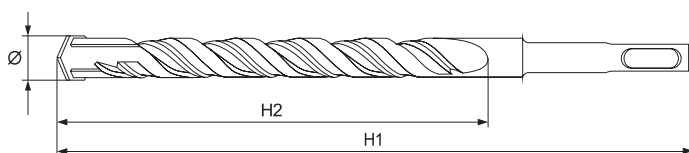

PLASTIC TUBE & PLASTIC HANGER



- for windows assembly
- without necessity of using screw anchors
- do montażu okien
- bez użycia kołków rozporowych

YATO	Ø (mm)	H1 (mm)	H2 (mm)	PCS packing:	
YT-41641	6.5	200	130	10	10/150
YT-41642	6.5	260	183	10	10/150

- GB Masonry drill bit
- D Betonspiralbohrer
- PL Wiertło do betonu
- RUS Сверло по бетону
- CZ Vrták na beton
- H Fúrészár betonhoz
- RO Burghiu pt. beton
- F Foret béton
- I Punta per cemento
- E Broca para hormigón
- CN 建工钻

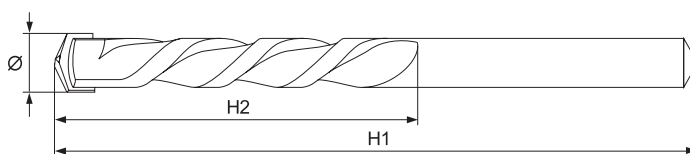

BLISTER CARD



YATO	Ø (mm)	H1 (mm)	H2 (mm)	
YT-4361	4	70	35	100/400
YT-4362	5	90	50	100/400
YT-4363	6	100	60	100/400
YT-4364	6	150	100	100/400
YT-4367	7	100	60	75/300

YATO	Ø (mm)	H1 (mm)	H2 (mm)	
YT-4369	8	120	80	75/300
YT-4370	8	200	140	50/150
YT-4375	10	120	80	75/300
YT-4376	10	200	140	50/150
YT-4379	12	150	100	50/150

YATO	Ø (mm)	H1 (mm)	H2 (mm)	
YT-4380	12	200	140	50/150
YT-4383	14	180	120	25/100
YT-4385	16	180	120	25/100

- GB Masonry drill bit set
- D Betonspiralbohrersatz
- PL Komplet wiertło do betonu
- RUS Сверла по бетону в наборе

- CZ Souprava vrtáků do betonu
- H Fúrészárkészlet betonhoz
- RO Set de burghie pt. beton
- F Set des forets béton

- I Set punte per cemento
- E Brocas para hormigón
- CN 建工钻组套

7 PCS



PLASTIC HANGING BOX



YATO	Ø (mm)	
YT-4390	4; 5; 6; 8; 9; 10; 12	10/80

GB Flat wood drill bit
D Schaufelbohrer
PL Wiertło łopatkowe do drewna

RUS Перовые сверло
CZ Plochý vrták
H Homlokmarós fúró
RO Burghiu plate

F Mèche à bois plate
I Punta per legno piatta
E Broca de aletas
CN 木工扁钻

DOUBLE
BLISTER



1/4"
(6.3mm)

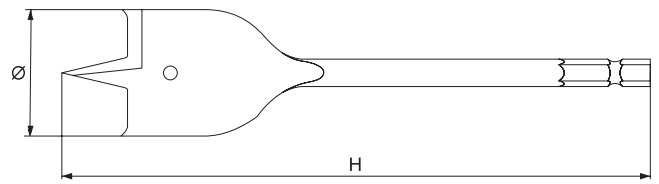

YATO	Ø (mm)	H (mm)	
YT-3236	6	152	50/400
YT-3237	8	152	50/400
YT-3238	10	152	30/300
YT-3239	12	152	50/300
YT-3240	13	152	50/300
YT-3241	14	152	50/300
YT-3242	16	152	50/300
YT-3243	18	152	50/300
YT-3244	20	152	50/300
YT-3245	22	152	50/300

YATO	Ø (mm)	H (mm)	
YT-3246	24	152	50/300
YT-3247	25	152	50/300
YT-3248	26	152	50/300
YT-3249	28	152	50/300
YT-3250	30	152	50/200
YT-3251	32	152	50/200
YT-3252	34	152	50/200
YT-3253	35	152	50/200
YT-3254	38	152	50/200
YT-3255	40	152	50/200

GB Extension for flat wood drill bits
D Verlängerung für Schaufelbohrer
PL Przedłużka do wiertel łopatkowych, bitów i wiertel

RUS Удлинитель для перовых сверл
CZ Nástavec pro ploché vrtáky
H Hosszabbító homlokmarós fafúrókhoz
RO Prelungitor pt. burghie plate
F Rallonge pour mèches à bois
I Prolunga per punta fresatrice
E Extensión para brocas de aletas
CN 木工扁钻延长杆

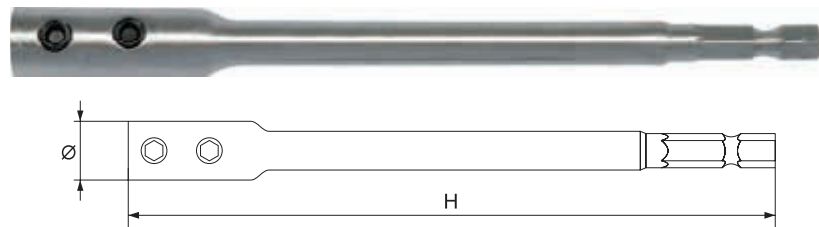

1/4"
(6.3mm)

DOUBLE
BLISTER

YATO	Ø (mm)	H (mm)	
YT-3256	12.2	150	60/120
YT-3257	13.5	300	30/60

GB Flat wood drill bit set
D Schaufelbohrersatz
PL Zestaw wiertel łopatkowych
RUS Набор перовых сверл
CZ Sada plochých vrtáků
H Homlokmarós fafúró készlet
RO Set burghie plate
F Set de mèche à bois
I Set di punta per legno piatta
E Juego de brocas de aletas
CN 木工扁钻组套

POUCH



6
PCS

1/4"
(6.3mm)

GB Flat wood drill bit set
D Schaufelbohrersatz
PL Zestaw wiertel łopatkowych
RUS Набор перовых сверл
CZ Sada plochých vrtáků
H Homlokmarós fafúró készlet
RO Set burghie plate
F Set de mèche à bois
I Set di punta per legno piatta
E Juego de brocas de aletas
CN 木工扁钻组套

PLASTIC
CASE
& DOUBLE
BLISTER



8
PCS

1/4"
(6.3mm)



YATO	Ø (mm)	H (mm)	
YT-3258	10; 12; 16; 18; 20; 25	152	25/50



YATO	Ø (mm)	H (mm)	
YT-3259	12; 16; 18; 20; 22; 25; 28; 32	152	5/20

GB Spur wood drill bit
D Spiralbohrer für Holz
PL Wiertło do drewna spiralne

RUS Спиральное сверло по дереву
CZ Vrták do dřeva spirálový
H Csigafúró fához

RO Burghiu spirală pt. lemn
F Meches hélicoïdales à bois
I Punta per legno spirale

E Barrena para madera espiral
CN 木工钻

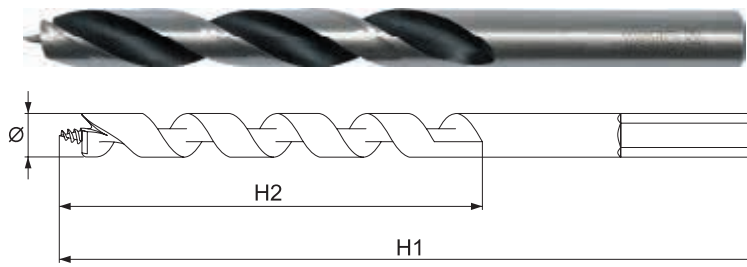

DOUBLE BLISTER

YATO	Ø (mm)	H1 (mm)	H2 (mm)	
YT-4350	3	60	35	30/300
YT-4351	4	75	44	30/300
YT-4352	5	85	52	30/300
YT-4353	6	90	57	30/300
YT-4354	7	100	67	30/300

YATO	Ø (mm)	H1 (mm)	H2 (mm)	
YT-4355	8	110	75	30/300
YT-4356	10	120	77	30/300
YT-4357	12	150	97	15/120
YT-4358	13	150	102	15/120
YT-4359	16	160	120	15/120

GB Auger wood drill bit
D Holzbohrer
PL Świdrer do drewna

RUS Бур по дереву
CZ Vrták do dřeva hadovitý
H Fafúró

RO Burghiu elicoidal pt. lemn
F Foret spirale à bois
I Punta a torciglione per legno

E Barrena para madera
CN 螺旋木工钻

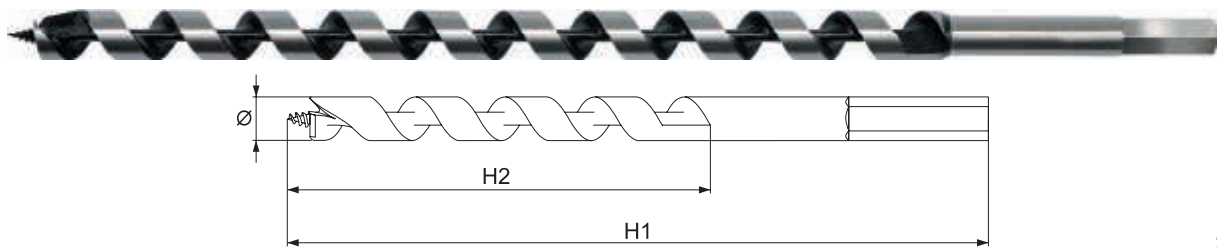

DOUBLE BLISTER

YATO	Ø (mm)	H1 (mm)	H2 (mm)	
YT-3261	6	191	121	60/360
YT-3262	8	191	121	70/280
YT-3263	8	400	310	60/120
YT-3264	10	191	121	50/200
YT-3265	10	400	310	50/100
YT-3266	12	191	121	50/150
YT-3267	12	400	310	20/60
YT-3268	13	191	121	50/100
YT-3269	13	400	310	20/60
YT-3270	14	191	121	50/100
YT-3271	14	400	310	20/60
YT-3272	16	191	121	50/100
YT-3273	16	400	310	20/40

YATO	Ø (mm)	H1 (mm)	H2 (mm)	
YT-3274	18	215	142	40/80
YT-3275	18	400	310	20/40
YT-3276	20	215	145	20/60
YT-3277	20	400	310	20/40
YT-3278	22	215	145	20/60
YT-3279	22	400	310	10/30
YT-3280	24	215	145	20/60
YT-3281	24	400	310	6/30
YT-3282	25	215	145	20/40
YT-3283	25	400	310	5/25
YT-3284	26	215	145	10/40
YT-3285	26	400	310	10/20
YT-3286	28	240	145	6/24

YATO	Ø (mm)	H1 (mm)	H2 (mm)	
YT-3287	28	400	310	5/20
YT-3288	30	240	170	10/30
YT-3289	30	400	310	5/10
YT-3290	32	240	170	5/25
YT-3291	32	400	310	5/15
YT-3292	35	240	170	5/20
YT-3293	35	400	310	5/10
YT-3294	36	240	170	10/20
YT-3295	36	400	310	5/10
YT-3296	38	240	170	5/15
YT-3297	40	240	170	5/15

GB Auger wood drill bit set
D Holzbohrersatz
PL Zestaw świdrów do drewna
RUS Набор буров по дереву
CZ Sada hadovitých vrtáků do dřeva
H Fafúró készlet
RO Set de burghie elicoidale pt. lemn
F Set de forets spirales à bois
I Set di punte a torciglione
E Juego de barrenas para madera
CN 螺旋木工钻组套



WOOD CASE & COLOR BOX

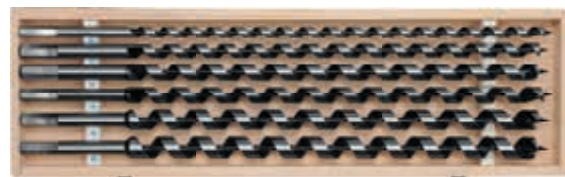

6 PCS
13mm

YATO	Ø (mm)	H (mm)	
YT-3299	10; 12; 14; 16; 18; 20	460	8



6 PCS	13mm	YATO	Ø (mm)	H (mm)	
		YT-3298	10; 12; 14; 16; 18; 20	230	15

6 PCS	SDS PLUS	YATO	Ø (mm)	H (mm)	
		YT-3300	10; 12; 14; 16; 18; 20	200	20

GB Drill for ceramic tiles
D Keramik und Fliesen Bohr
PL Wiertło do ceramiki i gresu
RUS Бурильные плитки и керамики
CZ Vrtací tašek a keramických výrobků

H Fúró cserép és kerámia
RO Gresie de foraj si produse ceramica
F Tuiles de forage et de la céramique

I Piastrelle e ceramiche trapano
E Azulejos y cerámicas de perforación
CN 玻璃钻

SLIDING CARD



YG6X
TUNGSTEN CARBIDE TIP
OSTRZE I WEGŁA
WOLFRAMU

HRA 90



YATO	Ø (mm)	
YT-3725	4	100/400
YT-3726	6	100/400

YATO	Ø (mm)	
YT-3727	8	100/400
YT-3728	10	50/200

GB Adjustable hand reamer
D Verstellbare Reibahle
PL Rozwiertak nastawny
RUS Регулируемая развертка

CZ Nastavitelný výstružník
H Állítható dörzsár
RO Alezor reglabil
F Alesoir à main réglable

I Alesatore regolabile
E Escariador ajustable
CN 可调式手动铰刀

PLASTIC TUBE



HSS 4241



YATO	working diameter / średnica robocza (mm)	L (mm)	arbor diameter / średnica trzpienia (mm)	
YT-28950	7.75-8.5	107	4.5	50/200
YT-28951	8.5-9.25	112	4.5	50/200
YT-28952	9.25-10	116	5.0	50/200
YT-28953	10-10.75	125	5.5	50/200
YT-28954	10.75-11.75	130	6.5	50/200
YT-28955	11.75-12.75	135	7.5	50/150
YT-28956	12.75-13.75	140	7.5	50/150
YT-28957	13.75-15.25	158	8.0	20/60
YT-28958	15.25-17	165	9.0	20/60

YATO	working diameter / średnica robocza (mm)	L (mm)	arbor diameter / średnica trzpienia (mm)	
YT-28959	17-19	175	10.0	20/60
YT-28960	19-21	180	11.5	20/60
YT-28961	21-23	193	13.5	20/60
YT-28962	23-26	210	15.4	4/20
YT-28963	26-29.5	245	17.0	4/20
YT-28964	29.5-33.5	270	19.0	4/12
YT-28965	33.5-38	310	21.0	2/10
YT-28966	38-44	345	24.0	2/10
YT-28967	44-54	400	30.0	5

GB Spot weld cutter & drill bit set
D Schweißpunktbohrer Set Schweißpunktfräser
PL Zestaw rozwiertaków do zgrzewów punktowych
RUS Набор для высверливания точечной сварки
CZ Sada na odvrtání bodových svárů
H Hegesztőpont maró készlet
RO Set de freze pt. sudurii în puncte
F Jeu de fraises pour points de soudage
I Set di alesatori per punti di saldatura
E Juego de puntos de soldadura de la fresa
CN 点焊刀



9 PCS
8 mm
10 mm
HSS

METAL BOX & COLOR BOX



YATO	
YT-28920	10/60

GB Drill welding points set
D Schweißpunkt-Fräasersatz
PL Zestaw wiertel do zgrzewów punktowych
RUS Набор сверл для точечной сварки
CZ Frézy pro bodové sváry
H Pont hegesztés lefúró készlet
RO Set burghiu puncte sudura
F Forets à dépointer les points soudure
I Set di alesatori per punti di saldatura
E Juego de brocas para puntos de soldadura
CN 3件套电焊



3 PCS
COBALT COATED
POKRYTE KOBALTEM

METAL BOX & COLOR BOX



YATO	Ø (mm)	
YT-28921	6.5; 8.0; 10.0	50

GB Combination edge setter / hole punch pliers
D Kombinierte Absetzange Lochzange
PL Dziurkarko-felcarka
RUS Дырокол, кромкогиб
CZ Falcovačka a děrovačka
H Lyukasztó peremező fogó

RO Cleste pt. fasonat si gaurit tabla
F Pince spéciale perforatrice carrosserie
I Combinazione: bordo setter / pinza perforare
E Solapadora y ponchadora manual
CN 点焊刀

13 mm
22 mm

Ø 5 mm
20 mm



HANGING COLOR BOX



YATO	
YT-21582	10

GB Point chisel SDS+
D Spitzmeißel SDS+
PL Przecinak SDS+

RUS Зубило SDS+
CZ Sekáč špičák SDS+
H Hegyes véső SDS+

RO Punctator SDS+
F Perçoir SDS+
I Scalpello SDS+

E Cíncel puntiagudo SDS+
CN SDS尖錐

PLASTIC HANGER

4x14
x250
mm **SDS PLUS** CrV



YATO	L (mm)	
YT-4720	250	6/48

GB Flat chisel SDS+
D Flachmeißel SDS+
PL Dłuto wąskie SDS+

RUS Долото узкое SDS+
CZ Sekáč plochý SDS+
H Lapos véső SDS+

RO Punctator pt. adancit SDS+
F Ciseau SDS+
I Scalpello punto stretto SDS+

E Cíncel plano estrecho SDS+
CN SDS平齒

PLASTIC HANGER

20x14
x250
mm **SDS PLUS** CrV



YATO	L (mm)	
YT-4721	250	6/48

GB Hollow chisel SDS+
D Nutenmeißel SDS+
PL Bruzdownik SDS+

RUS Бороздник SDS+
CZ Sekáč drážkovací SDS+
H Horonyvéső SDS+

RO Punctator pt. adancit SDS+
F Burin à entailler SDS+
I Calibro scalpello SDS+

E Cíncel acanalado SDS+
CN SDS空心齒

PLASTIC HANGER

22x18
x250
mm **SDS PLUS** CrV



YATO	L (mm)	
YT-4722	250	6/48

GB Flat chisel SDS+
D Spatmeißel SDS+
PL Dłuto płaskie SDS+

RUS Долото плоское SDS+
CZ Sekáč plochý SDS+
H Széles lapos véső SDS+

RO Punctator tip dalta SDS+
F Ciseau SDS+
I Scalpello piatto SDS+

E Cíncel plano SDS+
CN SDS平齒

PLASTIC HANGER

40x14
x250
mm **SDS PLUS** CrV



YATO	L (mm)	
YT-4723	250	6/48

GB Hollow drill set
D Bohrkronen
PL Wiertło koronowe do betonu
RUS Сверла по бетону корончатые

CZ Koronový vrták na zed
H Koronafúró falhoz
RO Burghiu cu coroană pt. beton
F Trépied à mur

I Punta a corona per calcestruzzo
E Broca widia para muro
CN 扩孔钻

COLOR BOX



TCT YG-11C **Cr50** 50mm **M16**



HEX
12mm

SDS PLUS

YATO	Ø (mm)	TCT	
YT-4400	65	6	24
YT-4401	80	8	20

YATO	Ø (mm)	TCT	
YT-4402	65	6	24
YT-4403	80	8	20

GB Bi-metal hole saw
D Bimetall-Lochsäge
PL Otwornica bimetalowa
RUS Ножовка к отверстиям би-металлическая
CZ Vrtací korunka bimetalová
H Bi-metál koronafúró

RO Găurător bi-metalic
F Scie-trépan bimétal
I Foro sega utensile da taglio bi-metallo
E Sierra de marquetería bi-metálica
CN 双金属孔锯



BI-METAL **4-6 TPI** 40mm



- application: industry
- to drill holes in stainless steels, cast steels, aluminium, wood, plastics
- cutting depth: 40 mm
- przeznaczenie: przemysł
- do wycinania otworów w stalach nierdzewnych, żelazie, aluminium, drewnie, tworzywach sztucznych
- głębokość cięcia: 40 mm

YATO	Ø (mm)	thread / gwint	
YT-3303	19	1/2" (12.5 mm)	25/100
YT-3304	20	1/2" (12.5 mm)	25/100
YT-3306	22	1/2" (12.5 mm)	25/100
YT-3308	25	1/2" (12.5 mm)	25/100
YT-3311	29	1/2" (12.5 mm)	25/100
YT-3313	32	5/8" (16 mm)	25/100
YT-3315	35	5/8" (16 mm)	25/100
YT-3317	38	5/8" (16 mm)	25/100
YT-3318	40	5/8" (16 mm)	25/100
YT-3321	44	5/8" (16 mm)	25/100

YATO	Ø (mm)	thread / gwint	
YT-3322	46	5/8" (16 mm)	25/100
YT-3323	48	5/8" (16 mm)	25/100
YT-3324	51	5/8" (16 mm)	25/100
YT-3327	57	5/8" (16 mm)	25/50
YT-3329	60	5/8" (16 mm)	25/50
YT-3330	64	5/8" (16 mm)	25/50
YT-3332	67	5/8" (16 mm)	25/50
YT-3333	68	5/8" (16 mm)	25/50
YT-3334	70	5/8" (16 mm)	25/50
YT-3336	76	5/8" (16 mm)	25/50

YATO	Ø (mm)	thread / gwint	
YT-3338	83	5/8" (16 mm)	25/50
YT-3343	95	5/8" (16 mm)	25/50
YT-3345	102	5/8" (16 mm)	10/20
YT-3346	105	5/8" (16 mm)	10/20
YT-3349	114	5/8" (16 mm)	10/20
YT-3350	121	5/8" (16 mm)	10/20
YT-3351	127	5/8" (16 mm)	10/20
YT-3353	140	5/8" (16 mm)	10/20

GB Arbor for hole saw
D Halterung für Lochsägen
PL Uchwyt do otwornic
RUS Рукоятка к ножовке
CZ Šroubový unášec pro vrtací korunky

H Befogószár a koronafúróhoz
RO Dispozitiv de antrenare pt. găurătorii bimetaliți
F Mandrin aux scies-trépan

I Pergolato per sega
E Mango para las sierras de marquetería
CN 孔锯柄轴

DOUBLE BLISTER



HEX

SDS PLUS



1/2"
(12.5mm)
20UNF



5/8"
(16mm)
18UNF



5/8"
(16mm)
18UNF

YATO	SDS+ / HEX	
YT-3370	HEX 7/16" (11 mm)	25/100
YT-3373	SDS+	25/100

YATO	SDS+ / HEX	
YT-3371	HEX 7/16" (11 mm)	25/100

YATO	SDS+ / HEX	
YT-3372	HEX 7/16" (11 mm)	25/50
YT-3374	SDS+	25/50

GB Pilot drill
D Pilotbohrer
PL Wiertło pilot
RUS Сверло пилот
CZ Středící vrták
H Központfúró

RO Burghiu pilot
F Foret - pilot
I Punta pilota
E Broca piloto
CN 导向钻



DOUBLE BLISTER



HSS

YATO	Ø (mm)	H (mm)	
YT-3376	6.0	75	25/100

YATO	Ø (mm)	H (mm)	
YT-3377	6.0	100	25/100

GB Electrician's hole saw kit
D Lochsägensatz für Elektriker
PL Zestaw otwornic dla elektryków
RUS Набор ножовок к отверстиям для электриков
CZ Sada vrtacích korunek pro elektřikáře
H Koronafúró készlet villanyszerelőknék
RO Set de găuritori pt. electricieni
F Set de scies trépan aux électriciens
I Set universale a tazza fresa con strumenti
E Juego de sierras de marquetería para electricistas
CN 双金属开孔器组套



8
PCS

FOR CONSTRUCTION STEEL DO STALI (KONSTRUKCYJNE)

BI-METAL

4-6
TPI

40mm



BMC & COLOR SLEEVE

YATO	Ø (mm)	
YT-3380	22; 29; 35; 44; 67; 73	10

GB Combination hole saw kit
D Universal-Lochsägensatz
PL Uniwersalny zestaw otwornic
RUS Универсальный набор ножовок к отверстиям
CZ Univerzální sada vrtacích korunek
H Univerzális koronafúró készlet
RO Set univesal de găuritori
F Set de scies trépan universelles
I Set universale a tazza fresa con strumenti
E Juego universal de sierras de marquetería
CN 双金属开孔器组套



15
PCS

FOR CONSTRUCTION STEEL DO STALI (KONSTRUKCYJNE)

BI-METAL

4-6
TPI

40mm



BMC & COLOR SLEEVE

YATO	Ø (mm)	
YT-3381	19; 22; 25; 32; 35; 38; 44; 51; 57; 64; 76	5

- GB** Hand tap
- D** Handgewindebohrer
- PL** Gwintownik ręczny
- RUS** Ручной метчик
- CZ** Závitníky
- H** Menetfűró
- RO** Tarozi
- F** Taraud à main
- I** Maschi filettatura a mano
- E** Machos de roscar
- CN** 三件套手动丝锥



SLIDING CARD



3
PCS

DIN
352

HSS
M2

3-STAGE
TAPPING
GWINTOWANIE
(3-STOPNIOWE)

METRIC
COARSE
GWINT METRYCZNY
(GRUBOZYJOWY)

YATO	size x pitch rozmiar x skok gwintu	thread length (mm) długość gwintu (mm)	L (mm)	shank diameter (mm) średnica trzonu (mm)	PCS packing	weight (g) waga (g)	
YT-2930	M3x0.5	11	40	3.5	3	25	100/400
YT-2931	M4x0.7	13	45	4.5	3	35	50/200
YT-2932	M5x0.8	16	50	6.0	3	45	60/240
YT-2933	M6x1.0	19	50	6.0	3	45	60/240
YT-2934	M7x1.0	19	50	6.0	3	55	75/300
YT-2935	M8x1.25	22	56	6.0	3	60	50/200
YT-2937	M10x1.5	24	70	7.0	3	85	50/200

YATO	size x pitch rozmiar x skok gwintu	thread length (mm) długość gwintu (mm)	L (mm)	shank diameter (mm) średnica trzonu (mm)	PCS packing	weight (g) waga (g)	
YT-2939	M12x1.75	29	75	9.0	3	125	50/200
YT-2940	M14x2.0	30	80	10.5	3	200	20/80
YT-2941	M16x2.0	32	80	11.0	3	235	20/80
YT-2942	M18x2.5	40	95	12.0	3	345	20/80
YT-2943	M20x2.5	40	95	14.0	3	445	10/40
YT-2926	M22x2.5	40	100	18.0	3	600	10/40

- GB** Machine tap
- D** Maschinengewindebohrer
- PL** Gwintownik maszynowy
- RUS** Машинный метчик
- CZ** Strojní závitník
- H** Gépi menetfűró
- RO** Tarod de maşină
- F** Taraud machine
- I** Maschi filettatura
- E** Macho mecanico
- CN** 机用丝锥

DIN
371M

HSS
M2

1-STAGE
TAPPING
GWINTOWANIE
(1-STOPNIOWE)

METRIC
COARSE
GWINT METRYCZNY
(GRUBOZYJOWY)

- GB** Machine tap
- D** Maschinengewindebohrer
- PL** Gwintownik maszynowy
- RUS** Машинный метчик
- CZ** Strojní závitník
- H** Gépi menetfűró
- RO** Tarod de maşină
- F** Taraud machine
- I** Maschi filettatura
- E** Macho mecanico
- CN** 机用丝锥

DIN
376

HSS
M2

1-STAGE
TAPPING
GWINTOWANIE
(1-STOPNIOWE)

METRIC
COARSE
GWINT METRYCZNY
(GRUBOZYJOWY)



SLIDING CARD



YATO	size x pitch rozmiar x skok gwintu	thread length (mm) długość gwintu (mm)	L (mm)	shank diameter (mm) średnica trzonu (mm)	weight (g) waga (g)	
YT-2950	M3x0.5	11	56	3.5	15	100/400
YT-2951	M4x0.7	13	63	4.5	20	100/400
YT-2952	M5x0.8	16	70	6.0	25	60/240
YT-2953	M6x1.0	19	80	6.0	30	50/200
YT-2954	M7x1.0	19	80	7.1	35	30/120
YT-2955	M8x1.25	22	90	8.0	45	50/200
YT-2956	M10x1.5	24	100	10.0	65	50/200

YATO	size x pitch rozmiar x skok gwintu	thread length (mm) długość gwintu (mm)	L (mm)	shank diameter (mm) średnica trzonu (mm)	weight (g) waga (g)	
YT-2944	M12x1.75	29	110	9.0	70	25/100
YT-2945	M14x2.0	30	110	11.0	110	25/100
YT-2946	M16x2.0	32	110	12.0	120	25/100
YT-2947	M18x2.5	34	125	14.0	200	25/100
YT-2948	M20x2.5	34	140	16.0	260	25/100
YT-2949	M22x2.5	34	140	18.0	340	20/80
YT-2957	M24x3.0	38	160	18.0	400	15/60
YT-2958	M27x3.0	38	160	20.0	500	15/60
YT-2959	M30x3.5	45	180	22.0	700	15/60

- GB** Taps and dies set
- D** Gewindeschneidwerkzeug-Satz
- PL** Zestaw narzynek i gwintowników
- RUS** Набор плашек и метчиков
- CZ** Souprava závitníků a kruhových závitových čelistí
- H** Menetfűró és menetvágó készlet
- RO** Set de tarozi și filiere
- F** Set de filières et tarauds
- I** Set di filiera a maschi
- E** Juego de machosde roscar y cojinetes
- CN** 丝锥板牙组套



HSS

44
PCS

DIN223
DIN225
DIN338
DIN352
DIN1814



YATO	size / rozmiar	
YT-2978	M3; M4; M5; M6; M8; M10; M12	4



32
PCS

DIN223
DIN352

YATO	size / rozmiar	
YT-2975	M3; M4; M5; M6; M8; M10; M12	10



56
PCS

DIN223
DIN225
DIN352
DIN1814

YATO	size / rozmiar	
YT-2979	M3; M4; M5; M6; M8; M10; M12; M14; M16; M18; M20	2

- GB** Taps set
D Gewindeschneidwerkzeug-Satz
PL Zestaw gwintowników
RUS Набор метчиков
CZ Souprava závitníků
H Menetfúró készlet
RO Set de tarozi
F Set de tarauds
I Set di filettature
E Juego de machos de roscar
CN 丝锥组套



29
PCS

DIN338
DIN352
DIN1814



21
PCS

DIN
352

YATO	size / rozmiar	20
YT-2976	M3; M4; M5; M6; M8; M10; M12	

YATO	size / rozmiar	12
YT-2977	M3; M4; M5; M6; M8; M10; M12	

- GB** Circular die
D Schneideisen
PL Narzynka
RUS Плашка
CZ Kruhová závitová čelist
H Menetvágó
RO Filieră
F Filière
I Filiere tonde filettatura
E Cojnete de roscar
CN 圆板牙

SLIDING
CARD



YATO	size x pitch rozmiar x skok gwintu	outside diameter (mm) średnica zewnętrzna (mm)	thickness (mm) grubość (mm)	weight (g) waga (g)
YT-2961	M4x0.7	20	5	20
YT-2962	M5x0.8	20	7	20
YT-2963	M6x1.0	20	7	20
YT-2964	M7x1.0	25	9	35
YT-2965	M8x1.25	25	9	35
YT-2967	M10x1.5	30	11	50
YT-2969	M12x1.75	38	14	90
YT-2970	M14x2.0	38	14	95

YATO	size x pitch rozmiar x skok gwintu	outside diameter (mm) średnica zewnętrzna (mm)	thickness (mm) grubość (mm)	weight (g) waga (g)
YT-2971	M16x2.0	45	18	160
YT-2972	M18x2.5	45	18	160
YT-2973	M20x2.5	45	18	150
YT-2960	M22x2.5	55	22	300
YT-2966	M24x3.0	55	22	300
YT-2968	M27x3.0	65	25	400
YT-2974	M30x3.5	65	25	400

10

- GB** Step drill
D Stufenbohrer
PL Wiertło stopniowe
RUS Сверло ступенчатое
CZ Stupňovitý vrták
H Lépcsős fúró
RO Burghiu din titan cu gaurire in trepte
F Étape de forage
I Punta da trapano graduata
E Broca cónica escalonada
CN 論杓耶

DOUBLE
BLISTER



12
STEPS
STOPNI

6-38
mm

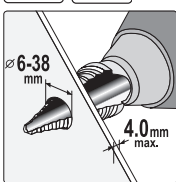

10
STEPS
STOPNI

4-22
mm

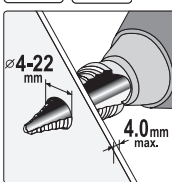

YATO	Ø (mm)	10/60
YT-44740	6; 8; 11; 14; 17; 20; 23; 26; 29; 32; 35; 38	

YATO	Ø (mm)	25/50
YT-44741	4; 6; 8; 10; 12; 14; 16; 18; 20; 22	

- GB** T-handle tap wrench
D Werkzeughalter für Gewinde
PL Pokrętło typu „T” do gwintowników
RUS Рукоятка типа „Т” к гаечному ключу
CZ Vratidlo na závitníky typ „T”
H Menetfúró befogó T-nyelű
RO Port tarod cu maner
F Porte-taraud type „T”
I Chiave giramaschio tipo „T” per maschi
E Llave giramachos „T”
CN 丝锥扳手



SLIDING
CARD



- GB** Ratchet tap wrench
D Werkzeughalter
PL Grzechotka do gwintownika
RUS Трещетка для метчика
CZ Rečtačka na závitník
H Racsnis hajtószer menetfúróhoz
RO Port tarod
F Porte-taraud à cliquet
I Chiave giramaschi a cricchetto
E Carraca para macho de roscar
CN 棘轮丝锥扳手



SLIDING
CARD



YATO	size / rozmiar	L (mm)	20/80
YT-2986	M3-M8	70	
YT-2987	M5-M10	80	
YT-2988	M6-M12	90	

YATO	size / rozmiar	L (mm)	20/80
YT-2989	M3-M10	85	
YT-2997	M3-M10	250	
YT-2990	M5-M12	100	
YT-2991	M5-M12	300	

- GB** Die handle
D Schneideisenhalter
PL Oprawa do narzynek
RUS Плашкодержатель
- CZ** Závitová objímka
H Menetvágó tartó
RO Portfilieră
F Porte-filière
- I** Porta filiere
E Portacojinete
CN 板牙铰手



SLIDING CARD

DIN 225



YATO	size / rozmiar	Ø (mm)	L (mm)	
YT-2980	M3-M4	20x5	200	25/100
YT-2981	M4.5-M6	20x7	200	25/100
YT-2982	M7-M9	25x9	224	25/100
YT-2983	M10-M11	30x11	280	25/50
YT-2984	M12-M14	38x14	315	15/30
YT-2985	M16-M20	45x18	450	10/20

- GB** Tap wrench
D Werkzeughalter für Gewinde
PL Pokrętko do gwintowników
RUS Вороток для метчиков
- CZ** Ovládací kolečko na závitník
H Hajtószar menetfúróhoz
- RO** Cheie (mâner) pt. tarod
F Porte-taraud
I Manopola per il maschio
- E** Llave giramachos
CN 一型丝锥铰手



SLIDING CARD

DIN 1814



YATO	size / rozmiar	L (mm)	
YT-2995	M1-M8	125	50/200
YT-2996	M3-M10	180	25/100
YT-2992	M3-M12	200	25/100
YT-2993	M4-M12	280	25/100
YT-2994	M5-M20	375	20/40

- GB** Thread repair set
D Reparatursatz für Gewinde
PL Zestaw do naprawy gwintów
RUS Набор для ремонта резьбы
- CZ** Souprava na opravu závitů
H Menetjavító készlet
RO Set pt. reparare filete
F Set d'helicoils
- I** Kit di riparazione per filettature
E Juego para reparar roscas
CN 螺纹修复组套



METAL BOX & COLOR BOX

HSS 4341

STAINLESS STEEL STAL NERDZEWA



88 PCS

YATO	size / rozmiar	
YT-1769	M6 x 1.0 x 10.8 mm	5/10
	M8 x 1.25 x 10.8 mm	
	M10 x 1.5 x 13.5 mm	



131 PCS

YATO	size / rozmiar	
YT-1763	M5 x 0.8 x 6.7 mm	5/10
	M6 x 1.0 x 10.8 mm	
	M8 x 1.25 x 10.8 mm	
	M10 x 1.5 x 13.5 mm	
	M12 x 1.75 x 16.3 mm	

- GB** Wire threads
D Spiraleinlagen für Gewindereparatur
PL Wkłady spiralne do naprawy gwintów
RUS Метчики и сверла для ремонта резьбы
- CZ** Spirálové vložky na opravu závitů
H Menetjavító betétek
RO Inserții spirala pt. reparare filete
F Helicoil
- I** Inserti a spirale per riparazione
E Elementos espirales para reparar roscas
CN 螺纹修复组套

for / dla: YT-1763, YT-1769

STAINLESS STEEL STAL NERDZEWA



POLYBAG WITH HEADER



YATO	size / rozmiar	PCS packaging	
YT-1764	M5 x 0.8 x 6.7 mm	20	50/250
YT-1765	M6 x 1.0 x 10.8 mm	20	50/250
YT-1766	M8 x 1.25 x 10.8 mm	20	50/200
YT-1767	M10 x 1.5 x 13.5 mm	15	25/100
YT-1768	M12 x 1.75 x 16.3 mm	10	25/100

- GB** Router bit set
- D** Oberfräsersatz
- PL** Zestaw frezów do drewna
- RUS** Набор фрез по дереву
- CZ** Souprava frézů do dřeva
- H** Medtjo frezj kompletas
- RO** Set de freze pt. lemn
- F** Fraises pour le bois
- I** Set di frese per legno
- E** Juego de frezas para madera
- CN** 木工铣刀组套



ALUMINIUM CASE & COLOR SLEEVE

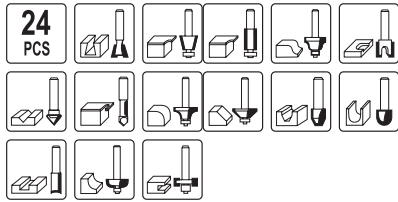

YATO **YT-6801** 10

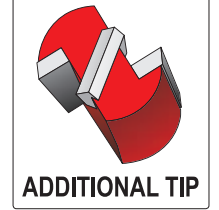

Router bit parameter												
Shank diameter [mm]	8	8	8	8	8	8	8	8	8	8	8	8
Length [mm]	42.0	47.0	47.0	43.5	50.0	51.5	51.0	52.0	58.0	51.5	58.0	56.5
Router bit diameter [mm]	12.7	12.7	9.5	12.7	12.7	9.5	12.7	16.0	6.35	6.35	9.5	12.7
Cutting edge length [mm]	12.7	14.8	11.6	13.0	12.5	20.0	20.0	9.5	19.5	20.0	24.5	25.0
Curvature radius [mm]	-	-	-	-	-	4.75	6.35	-	-	-	-	-
Bearing diameter [mm]	-	-	-	-	-	-	-	12.7	-	-	-	-
Angle [°]	-	15	10	-	45	-	-	15	-	-	-	-
Router bit parameter												
Shank diameter [mm]	8	8	8	8	8	8	8	8	8	8	8	8
Length [mm]	52.0	65.0	51.0	51.5	53.5	57.5	50.5	53.5	52.0	55.0	50.0	54.0
Router bit diameter [mm]	19.0	12.7	19.0	22.0	26.0	32.0	22.0	28.5	27.0	30.0	32.0	32.0
Cutting edge length [mm]	20.4	25.0	9.5	10.0	11.5	16.5	9.72	13.5	12.3	14.0	6.35	12.7
Curvature radius [mm]	-	-	3.2	4.76	6.35	9.5	6.35	9.5	4.0	-	-	-
Bearing diameter [mm]	-	12.7	-	12.7	12.7	12.7	9.5	9.5	9.5	12.7	12.7	12.7
Angle [°]	-	-	-	-	-	-	-	-	-	45	-	-

10



Router bit parameter																								
Shank diameter [mm]	8	8	8	8	8	8	8	8	8	8	8	8	8	8	8	8	8	8	8	8	8	8	8	8
Length [mm]	43.0	38.0	38.0	50.5	42.0	43.5	51.5	49.5	51.5	58.0	58.5	56.5	52.0	58.0	53.5	66.0	53.0	65.0	-	-	-	-	-	-
Router bit diameter [mm]	6.35	12.7	12.7	12.7	12.7	12.7	14.3	3.175	6.35	9.5	12.7	12.7	19.0	6.35	9.5	9.5	12.7	12.7	-	-	-	-	-	-
Cutting edge length [mm]	6.0	9.5	9.5	18.0	12.7	13.0	12.3	13.0	20.0	24.5	20.3	25.0	20.4	19.5	15.0	26.0	15.0	25.0	-	-	-	-	-	-
Curvature radius [mm]	3.175	6.35	-	6.35	-	-	-	-	-	-	-	-	-	-	-	-	-	-	-	-	-	-	-	-
Bearing diameter [mm]	-	-	-	-	-	-	-	-	-	-	-	-	-	-	9.5	9.5	12.7	12.7	-	-	-	-	-	-
Angle [°]	-	-	45	-	-	10	14	-	-	-	-	-	-	-	-	-	-	-	-	-	-	-	-	-
Router bit parameter																								
Shank diameter [mm]	8	8	8	8	8	8	8	8	8	8	8	8	8	8	8	8	8	8	8	8	8	8	8	8
Length [mm]	65.5	55.0	51.0	55.0	50.0	52.5	54.0	55.5	60.0	60.0	56.0	60.0	52.5	58.0	53.5	57.5	61.0	-	-	-	-	-	-	-
Router bit diameter [mm]	19.0	30.0	26.0	32.0	32.0	32.0	32.0	32.0	32.0	38.0	32.0	38.0	26.0	38.0	26.0	32.0	38.0	-	-	-	-	-	-	-
Cutting edge length [mm]	26.0	14.0	9.7	13.3	6.35	8.0	9.5	15.0	18.5	20.0	16.0	19.0	12.5	17.8	11.5	16.5	20.8	-	-	-	-	-	-	-
Curvature radius [mm]	-	-	6.35	9.5	-	-	-	8.0	4.76	12.7	4.76	6.35	3.175	6.35	6.35	9.5	12.7	-	-	-	-	-	-	-
Bearing diameter [mm]	19.0	12.7	12.7	12.7	12.7	12.7	12.7	9.5	12.7	9.5	9.5	9.5	9.5	9.5	12.7	12.7	12.7	-	-	-	-	-	-	-
Angle [°]	-	45	-	-	-	-	-	-	-	-	-	-	-	-	-	-	-	-	-	-	-	-	-	-

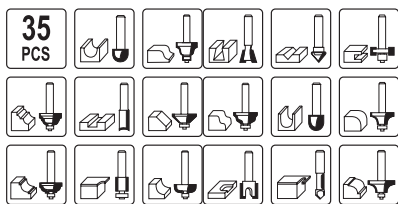

YATO **YT-6803** 10

- GB** Diamond blade
D Diamant-Trennscheibe
PL Tarcza diamentowa
RUS Отрезной алмазный диск
CZ Diamantový kotouč
H Gyémántkorong
- RO** Disc cu diamant
F Disque diamant
I Disco diamantato
E Disco de diamante
CN 金刚石切片

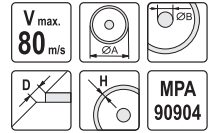
 DOUBLE
 BLISTER

- application: concrete, brick, calcium-silicate brick, tile, masonry, stone
- przeznaczenie: beton utwardzony, cegła, cegła silikatowa, granit, mur, kamień

- application: ceramic, gres, glaze, glass, porcelain
- przeznaczenie: płytki ceramiczne, gres, glazura, płytki kamienne, szkło, porcelana

- application: concrete, reinforced concrete, brick, tile, masonry, stone, sandstone
- przeznaczenie: beton utwardzony, beton zbrojony, cegła, granit, mur, kamień, piaskowiec

YATO	ØA (mm)	ØB (mm)	Ø R.P.M.max.	D (mm)	H (mm)	
YT-6002	115	22.2	12000	2.1	8.0	20/200
YT-6003	125	22.2	11000	2.2	8.0	20/160
YT-6004	180	22.2	8000	2.5	8.0	15/60
YT-6005	230	22.2	6500	2.7	8.0	10/40

YATO	ØA (mm)	ØB (mm)	Ø R.P.M.max.	D (mm)	H (mm)	
YT-6012	115	22.2	12000	2.1	5.3	20/200
YT-6013	125	22.2	11000	2.2	5.3	20/160
YT-6014	180	22.2	8000	2.5	5.3	15/60
YT-6015	230	22.2	6500	2.7	5.3	10/40
YT-6016	180	25.4	8000	2.2	5.3	15/60
YT-6017	200	25.4	8000	2.2	5.3	10/40

YATO	ØA (mm)	ØB (mm)	Ø R.P.M.max.	D (mm)	H (mm)	
YT-6022	115	22.2	12000	2.4	8.0	20/200
YT-6023	125	22.2	11000	2.6	8.0	20/160
YT-6024	180	22.2	8000	2.8	8.0	15/60
YT-6025	230	22.2	6500	3.1	8.0	10/40

- GB** Diamond grinding cup wheel
D Diamant Schleifopf Schleifteller
PL Tarcza szlifierska diamentowa
RUS Алмазный диск шлифовальный
CZ Diamantový brusný kotouč
H Gyémánt csiszoló kúpos
RO Disc cupa diamantat pt. slefuit
F Disque diamant
I Disco diamantato
E Disco diamante de lijar
CN 金刚石杯型磨轮

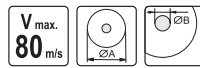
 HANGING
 COLOR BOX

- application: concrete, clinkier, natural stone, screed
- przeznaczenie: beton utwardzony, klinkier, kamień naturalny, jastrych

YATO	ØA (mm)	ØB (mm)	R.P.M.max.	segment size (mm)	
YT-6030	125	22.2	12200	5.0x7.5	20
YT-6032	125	22.2	12200	4.5x20.0	20

- GB** Diamond core bit drilling holes for sockets
D Diamant-Bohrkrone
PL Diamentowe wiertło koronowe
RUS Алмазное сверло корончатое
CZ Diamantový korunkový vrták
H Gyémánt fúrókorona
RO Carota diamantata pt. beton
F Trépiéd à mur diamantées
I Corona diamantata per calcestruzzo
E Corona con broca diamante
CN 金刚石薄壁钻



COLOR BOX



- application: concrete, calcium-silicate brick, porous ceramics
- przeznaczenie: beton utwardzony, cegła silikatowa, ceramika poryzowana

YATO	Ø (mm)	R.P.M.max.	segment size (mm)	
YT-6045	68	1030	3.5x10x24	24
YT-6046	82	850	3.5x10x24	20

- GB** TCT circular saw blade for wood
- D** Kreissägeblatt HM-Bestückt
- PL** Piła tarczowa do drewna z węglikiem wolframu
- RUS** Диск пильный с карбидом вольфрама
- CZ** Kotoučová pila na dřevo z karbidem wolframu
- H** Wolframkarbidos körfűrész fához
- RO** Ferăstrău circular cu dinți din wolfram pt. lemn
- F** Lame de scie circulaire carburé
- I** Lama troncatrice taglio legno
- E** Disco de sierra con carbono de tungsteno
- CN** 木工锯片



DOUBLE BLISTER



- application: for cutting wood and plastics
- przeznaczenie: do cięcia drewna, płyt drewnopochodnych, tworzyw sztucznych

YATO	Ø (mm)	d (mm)	RPM _{max}	D (mm)	metal disc thickness / grubość tarczy (mm)	number of teeth / ilość zębów (T)	
YT-6050	130	16.0	10000	2.8	2.0	24	25/50
YT-6052	140	20.0	10000	2.8	2.0	16	25/50
YT-60522	140	20.0	11000	2.8	2.0	30	25/50
YT-6053	140	16.0	10000	2.8	2.0	30	25/50
YT-60533	150	20.0	10000	2.8	2.0	30	25/50
YT-6055	160	20.0	9500	2.8	2.0	18	25/50
YT-6056	160	30.0	9500	2.8	2.0	24	25/50
YT-6057	160	30.0	9500	2.8	2.0	36	25/50
YT-6058	160	20.0	9500	2.8	2.0	48	25/50
YT-60582	170	16.0	9500	3.2	2.2	12	25/50
YT-60583	170	16.0	9500	3.2	2.2	40	25/50
YT-6060	184	30.0	9000	3.2	2.2	24	25/50
YT-6061	184	30.0	9000	3.2	2.2	40	25/50
YT-6062	184	30.0	9000	3.2	2.2	50	25/50
YT-6063	185	20.0	9000	2.4	1.4	18	25/50
YT-60633	190	16.0	8500	3.2	2.2	40	10/20
YT-60634	190	20.0	7100	2.2	1.5	24	25/50
YT-60488	190	30.0	8500	3.2	2.2	20	10/20
YT-60489	190	30.0	8500	3.2	2.2	40	10/20
YT-6065	200	30.0	8000	3.2	2.2	24	10/20
YT-60652	210	30.0	8000	3.2	2.2	40	10/20
YT-6066	205	18.0	6000	3.2	2.0	24	10/20

YATO	Ø (mm)	d (mm)	RPM _{max}	D (mm)	metal disc thickness / grubość tarczy (mm)	number of teeth / ilość zębów (T)	
YT-60665	210	30.0	7500	3.2	2.2	20	10/20
YT-60668	235	25.5	5800	2.5	1.8	24	25
YT-6067	210	30.0	8000	3.2	2.2	40	10/20
YT-6068	210	30.0	8000	3.2	2.2	60	10/20
YT-60682	216	30.0	7500	3.2	2.2	48	10/20
YT-6070	250	30.0	6000	3.2	2.2	24	10/20
YT-6071	250	30.0	6000	3.2	2.2	40	10/20
YT-6072	250	30.0	6000	3.2	2.2	60	10/20
YT-6075	300	30.0	6000	3.2	2.2	24	10
YT-6076	300	30.0	5000	3.2	2.2	40	10
YT-6077	300	30.0	5000	3.2	2.2	60	10
YT-6078	300	30.0	5000	3.2	2.2	96	10
YT-60790	315	30.0	4500	3.5	2.5	24	10
YT-60792	315	30.0	4500	3.5	2.5	48	10
YT-60794	315	30.0	4500	3.5	2.5	80	10
YT-6080	350	30.0	4500	3.5	2.5	28	10
YT-6081	350	30.0	4500	3.5	2.5	40	10
YT-6082	350	30.0	4500	3.5	2.5	54	10
YT-6083	350	30.0	4500	3.5	2.5	84	10
YT-6085	400	30.0	4000	3.8	2.8	32	10
YT-6086	400	30.0	4000	3.8	2.8	60	10

- GB** TCT circular saw blade for structural wood
- D** Kreissägeblatt HM-Bestückt von Holzkonstruktionen
- PL** Piła tarczowa z węglikiem wolframu do cięcia drewna konstrukcyjnego
- RUS** Диск пильный твердого сплава для резки строительной конструкционной древесины
- CZ** Kotoučová pila s karbidem wolframu k řezání konstrukčního dřeva
- H** Wolfram-karbid szegmens fűrészártsza szerkezeti fához
- RO** Ferăstrău circular cu dinți din wolfram pt. tăierea lemnului pt. construcții
- F** Lame de scie circulaire carbure pour construction bois
- I** Lama al tungsteno da legno
- E** Disco de sierra con carbono de tungsteno para corte de madera estructural
- CN** 木工圆锯片



DOUBLE BLISTER



YATO	Ø (mm)	d (mm)	RPM _{max}	D (mm)	metal disc thickness / grubość tarczy (mm)	number of teeth / ilość zębów (T)	
YT-60480	160	20	9500	2.2	1.5	24	25/50
YT-60482	180	20	9000	2.4	1.8	36	20/40
YT-60484	250	30	6000	2.4	1.8	48	10/20

- GB** TCT circular saw blade for aluminium
- D** Hartmetallbestückt Kreissägeblatt für Aluminium
- PL** Piła tarczowa do aluminium z węglikiem wolframu
- RUS** Диск пильный по алюминию
- CZ** Kotoučová pila na hliník s karbidem wolframu
- H** Wolframkarbidos körfűrészlap, alumíniumhoz
- RO** Disc circular pt. aluminiu
- F** Lame de scie circulaire pour aluminium
- I** Lama troncatrice alluminio
- E** Disco de sierra con carbono
- CN** 锯片



DOUBLE BLISTER



- application: for cutting aluminium profiles, laminates, plexi, corian and other plastics
- negative angle of teeth
- przeznaczenie: do cięcia profili aluminiowych, laminatów, plexi, korianu, tworzyw sztucznych
- negatywny kąt natarcia zębów

YATO	Ø (mm)	d (mm)	RPM _{max}	D (mm)	metal disc thickness / grubość tarczy (mm)	number of teeth / ilość zębów (T)	
YT-60905	160	20	9500	2.2	1.5	52	25/50
YT-60907	180	20	9000	2.2	1.5	60	20/40
YT-6091	200	30	8000	3.0	2.2	60	10/20
YT-6093	210	30	8000	3.0	2.2	72	10/20
YT-6095	250	30	6000	3.0	2.2	100	10/20
YT-6097	300	30	5000	3.0	2.2	100	10
YT-6099	350	30	4500	3.2	2.5	100	10

GB Saw rasp
D Sägeblatt für Einhandschleifer
PL Piła tamiłkowa
RUS Диск фрезы универсальный
CZ Rotační rašple
H Rotációs ráspoly
RO Disc raspe
F Disque de coupe
I Disco raspa a sega
E Disco de corte
CN 锯锉刀



TIED ON CARD



- cutting, ridging
- wood, cellular concrete, plastics, gypsum, drywall
- cięcie, bruzdowanie
- drewno, beton komórkowy, tworzywo sztuczne, gips, płyty gipsowo-kartonowe

YATO	Ø (mm)	Ø d (mm)	R.P.M.max.	D (mm)	
YT-59160	115	22.2	13000	5	10
YT-59161	125	22.2	13000	5	10
YT-59163	230	22.2	8000	5	10

GB Tapered rasp disc
D Raspelscheibe schräge Oberfläche
PL Tarnik skośny
RUS Диск фрезы универсальный по дереву для УШМ
CZ Rotační rašple
H Rotációs ráspoly
RO Disc raspe conic
F Disque râpe
I Disco raspa obliquo
E Disco escofina
CN 圆锥锉刀盘

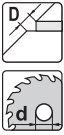
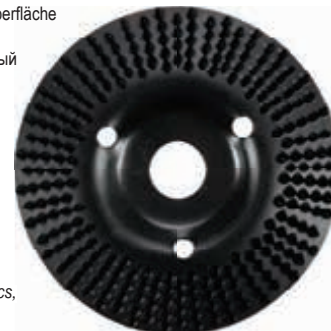

TIED ON CARD



- grinding, milling
- wood, cellular concrete, plastics, gypsum, drywall
- szlifowanie, frezowanie
- drewno, beton komórkowy, tworzywo sztuczne, gips, płyty gipsowo-kartonowe

YATO	Ø (mm)	Ø d (mm)	R.P.M.max.	#	
YT-59164	115	22.2	13000	2	10
YT-59165	125	22.2	13000	2	10

GB Tapered rasp disc
D Raspelscheibe schräge Oberfläche
PL Tarnik skośny
RUS Диск фрезы универсальный по дереву для УШМ
CZ Rotační rašple
H Rotációs ráspoly
RO Disc raspe conic
F Disque râpe
I Disco raspa obliquo
E Disco escofina
CN 圆锥锉刀盘



TIED ON CARD



- grinding, milling
- wood, cellular concrete, plastics, gypsum, drywall
- szlifowanie, frezowanie
- drewno, beton komórkowy, tworzywo sztuczne, gips, płyty gipsowo-kartonowe

YATO	Ø (mm)	Ø d (mm)	R.P.M.max.	#	
YT-59166	115	22.2	13000	1	10
YT-59167	125	22.2	13000	1	10

GB Tapered rasp disc
D Raspelscheibe gekröpft
PL Tarnik wypukły
RUS Диск фрезы универсальный по дереву для УШМ
CZ Rotační rašple
H Rotációs ráspoly
RO Disc raspe conic
F Disque râpe
I Disco raspa convesso
E Disco escofina
CN 锯片

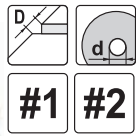

TIED ON CARD



- grinding, milling
- wood, cellular concrete, plastics, gypsum, drywall
- szlifowanie, frezowanie
- drewno, beton komórkowy, tworzywo sztuczne, gips, płyty gipsowo-kartonowe

YATO	Ø (mm)	Ø d (mm)	R.P.M.max.	#	
YT-59168	125	22.2	13000	1	10
YT-59169	125	22.2	13000	2	10
YT-59170	125	22.2	13000	3	10

GB Saw rasp
D Raspelscheibe mit Säge
PL Tarnik z piłą
RUS Диск фрезы универсальный по дереву для УШМ
CZ Rotační rašple
H Rotációs ráspoly
RO Disc raspe
F Disque râpe
I Disco raspa a sega
E Disco escofina
CN 锯片



TIED ON CARD



- cutting, ridging, grinding, milling
- wood, cellular concrete, plastics, gypsum, drywall
- cięcie, bruzdowanie, szlifowanie, frezowanie
- drewno, beton komórkowy, tworzywo sztuczne, gips, płyty gipsowo-kartonowe

YATO	Ø (mm)	Ø d (mm)	R.P.M.max.	D (mm)	#	
YT-59171	115	22.2	13000	5	1	10
YT-59172	125	22.2	13000	5	1	10

GB Saw rasp tapered fine
D Raspelscheibe gekröpft mit Säge
PL Tarnik wypukły z piłą
RUS Диск фрезы универсальный по дереву для УШМ
CZ Rotační rašple
H Rotációs ráspoly
RO Disc raspe conic
F Disque râpe
I Disco raspa convesso con sega
E Disco escofina
CN 锯片



TIED ON CARD



- cutting, ridging, grinding, milling
- wood, cellular concrete, plastics, gypsum, drywall
- cięcie, bruzdowanie, szlifowanie, frezowanie
- drewno, beton komórkowy, tworzywo sztuczne, gips, płyty gipsowo-kartonowe

YATO	Ø (mm)	Ø d (mm)	R.P.M.max.	D (mm)	#	
YT-59173	115	22.2	13000	5	1	10
YT-59174	125	22.2	13000	5	1	10

GB Rasp milling cutter
D Raspelräs-scheibe
PL Frez tarnikowy
RUS Фреза по дереву для УШМ
CZ Rotační rašple
H Rotációs ráspoly
RO Disc raspe conic
F Fraise râpe

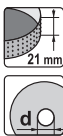

TIED ON CARD



- milling, ridging
- wood, cellular concrete, plastics, gypsum, drywall
- frezowanie, bruzdowanie
- drewno, beton komórkowy, tworzywo sztuczne, gips, płyty gipsowo-kartonowe

YATO	Ø (mm)	Ø d (mm)	R.P.M.max.	milling cutter height / wysokość frezu (mm)	
YT-59175	90	22.2	13000	21	10
YT-59176	118	22.2	13000	21	10

GB Rasp milling cutter
D Raspelräs universalscheibe
PL Frez tarnikowy uniwersalny
RUS Фреза по дереву для УШМ
CZ Rotační rašple
H Rotációs ráspoly
RO Disc raspe conic
F Fraise râpe

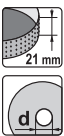

TIED ON CARD



- milling, grinding, ridging
- wood, cellular concrete, plastics, gypsum, drywall
- frezowanie, szlifowanie, bruzdowanie
- drewno, beton komórkowy, tworzywo sztuczne, gips, płyty gipsowo-kartonowe

YATO	Ø (mm)	Ø d (mm)	R.P.M.max.	milling cutter height / wysokość frezu (mm)	#	
YT-59177	118	22.2	13000	21	1	10

- GB** Cable cutter
D Kabelschere
PL Szczypce do cięcia przewodów
RUS Кабелерезы
CZ Elektrické upichováký
H Kábelvágó
RO Patent tăietor pt. electrice
F Pince à couper les fils
I Pinze per tagliare i cavi
E Tijeras para cables
CN 电缆剪



SLIDING CARD

160 mm
210 mm
240 mm
CrV 50
DROPP FORGED STEEL
STAL KUTA NA ZIMNO
HRC 55-60

YATO	L (mm)	max. Ø (mm)	
YT-1966	160	6	6/60
YT-1967	210	7	6/60
YT-1968	240	8	6/48

- GB** Insulated cable cutter
D Kabelschere
PL Szczypce do cięcia przewodów izolowane
RUS Кабелерезы
CZ Elektrické upichováký, izolované
H Kábelvágó
RO Cleste tăiat cabluri izolat
F Pince renforcée isolée
I Pinze per tagliare i cavi isolati
E Tijeras para cables aislantes
CN 绝缘电缆剪



250 mm
CrV
1000 V
D'E

YATO	L (mm)	max. Ø (mm)	
YT-21141	250	80	6/36

1000V VDE CERTIFICATE EN 60900:2012

- GB** Heavy duty cable cutter
D Schwere Drahtschere
PL Wzmocnione nożyce do cięcia przewodów
RUS Кабелерезы
CZ Elektrické upichováký
H Kábelvágó
RO Patent tăietor pt. electrice



- F** Pince renforcée à couper les fils
I Pinze per tagliare i cavi
E Tijeras para cables
CN 电缆剪

SLIDING CARD

240 mm
CrV 50
DROPP FORGED STEEL
STAL KUTA NA ZIMNO
HRC 55-60

YATO	L (mm)	max. Ø (mm)	
YT-1969	240	9	6/48

- application: for copper and aluminium electric cables
 • przeznaczenie: do cięcia miedzianych i aluminiowych kabli

- GB** Heavy duty cable cutter
D Schwere Drahtschere
PL Wzmocnione nożyce do cięcia przewodów
RUS Кабелерезы
CZ Elektrické upichováký
H Kábelvágó
RO Patent tăietor pt. electrice
F Pince renforcée à couper les fils
I Pinze per tagliare i cavi
E Tijeras para cables
CN 电缆剪



SLIDING CARD

230 mm
HRC 58-61
CrMo
Lever for increase cutting power
Ideal for copper and aluminium electric cables

YATO	L (mm)	max. Ø (mm)	
YT-1933	230	9	6/36

- GB** Tin snips
D Blechschere
PL Nożyce do cięcia blachy

- RUS** Ножницы по металлу
CZ Nůžky na plech
H Lemezvágó olló

- RO** Foarface pt. tablă
F Cisaille à tôle
I Cesioie per lamiera

- E** Tijeras para chapas
CN 铁皮剪

SLIDING CARD

LEFT CUT
CIECIE
LEWE
CrMo
INCREASED CUTTING POWER
ZWIĘKSZONA SIŁA CIĘCIA



HRC 60-62
DIN 6438

YATO	L (mm)	cutting length (mm)	cutting capacities (mm)				
			copper	cold-rolled steel	hard steel HRC35	stainless steel 304	
YT-1910	260	35	1.80	1.50	1.00	0.90	6/36



HRC 60-62
DIN 6438

YATO	L (mm)	cutting length (mm)	cutting capacities (mm)				
			copper	cold-rolled steel	hard steel HRC35	stainless steel 304	
YT-1915	235	30	1.50	1.20	1.00	0.70	6/36



HRC 60-62
DIN 6438

YATO	L (mm)	cutting length (mm)	cutting capacities (mm)				
			copper	cold-rolled steel	hard steel HRC35	stainless steel 304	
YT-1918	260	32	1.80	1.50	1.00	0.90	6/36



HRC 56-62
SERRATED EDGES
ZĄBKOWANA KRAWĘDZ
OSTRZY
HIGH FREQUENCY HARDENING
HARTOWANIE
IMPULSOWE

YATO	L (mm)	cutting length (mm)	cutting capacities (mm)				
			copper	cold-rolled steel	hard steel HRC35	stainless steel 304	
YT-1960	250	40	2.00	1.50	1.00	0.80	6/36

GB Tin snips
D Blechscherer
PL Nożyce do cięcia blachy
RUS Ножницы по металлу
CZ Nůžky na plech
H Lemezvágó olló
RO Foarfece pt. tablă
F Cisaille à tôle
I Cesole per lamiera
E Tijeras para chapas
CN 铁皮剪



SLIDING CARD



LEFT CUT
CIECIE LEWE

HRC 60-62

CrMo

90°

SERRATED EDGES
ZĄBKOWANA KRAWĘDZ
OSTRZY



YATO	L (mm)	cutting length (mm)	cutting capacities (mm)				6/36
			copper	cold-rolled steel	hard steel HRC35	stainless steel 304	
YT-1913	225	30	0.78	0.53	0.46	0.36	6/36

GB Tin snips
D Blechscherer
PL Nożyce do cięcia blachy
RUS Ножницы по металлу

CZ Nůžky na plech
H Lemezvágó olló
RO Foarfece pt. tablă
F Cisaille à tôle

I Cesole per lamiera
E Tijeras para chapas
CN 铁皮剪

SLIDING CARD



STRAIGHT CUT
CIECIE PROSTE

CrMo

INCREASED CUTTING POWER
ZWIĘKSZONA SIŁA CIECIA



HRC 60-62

DIN 6438

HRC 60-62

DIN 6438

YATO	L (mm)	cutting length (mm)	cutting capacities (mm)				6/36
			copper	cold-rolled steel	hard steel HRC35	stainless steel 304	
YT-1912	260	35	1.80	1.50	1.00	0.90	6/36

YATO	L (mm)	cutting length (mm)	cutting capacities (mm)				6/36
			copper	cold-rolled steel	hard steel HRC35	stainless steel 304	
YT-1922	290	75	1.10	0.94	0.70	0.53	6/36

HRC 60-62

DIN 6438



HRC 56-62

SERRATED EDGES
ZĄBKOWANA KRAWĘDZ
OSTRZY

HIGH FREQUENCY HARDENING
HARTOWANIE
IMPULSOWE

YATO	L (mm)	cutting length (mm)	cutting capacities (mm)				6/36
			copper	cold-rolled steel	hard steel HRC35	stainless steel 304	
YT-1923	230	25	2.00	1.60	1.20	1.20	6/36

YATO	L (mm)	cutting length (mm)	cutting capacities (mm)				6/36
			copper	cold-rolled steel	hard steel HRC35	stainless steel 304	
YT-1962	250	45	2.00	1.50	1.00	0.80	6/36

GB Tin snips
D Blechscherer
PL Nożyce do cięcia blachy
RUS Ножницы по металлу

CZ Nůžky na plech
H Lemezvágó olló
RO Foarfece pt. tablă
F Cisaille à tôle

I Cesole per lamiera
E Tijeras para chapas
CN 铁皮剪

SLIDING CARD



RIGHT CUT
CIECIE PRAWO

CrMo

INCREASED CUTTING POWER
ZWIĘKSZONA SIŁA CIECIA

HRC 60-62

DIN 6438



HRC 60-62

DIN 6438

YATO	L (mm)	cutting length (mm)	cutting capacities (mm)				6/36
			copper	cold-rolled steel	hard steel HRC35	stainless steel 304	
YT-1911	260	35	1.80	1.50	1.00	0.90	6/36

YATO	L (mm)	cutting length (mm)	cutting capacities (mm)				6/36
			copper	cold-rolled steel	hard steel HRC35	stainless steel 304	
YT-1916	235	30	1.50	1.20	1.00	0.70	6/36

HRC 60-62

DIN 6438



HRC 56-62

SERRATED EDGES
ZĄBKOWANA KRAWĘDZ
OSTRZY

HIGH FREQUENCY HARDENING
HARTOWANIE
IMPULSOWE

YATO	L (mm)	cutting length (mm)	cutting capacities (mm)				6/36
			copper	cold-rolled steel	hard steel HRC35	stainless steel 304	
YT-1919	260	32	1.80	1.50	1.00	0.90	6/36

YATO	L (mm)	cutting length (mm)	cutting capacities (mm)				6/36
			copper	cold-rolled steel	hard steel HRC35	stainless steel 304	
YT-1961	250	40	2.00	1.50	1.00	0.80	6/36

GB Tin snips
D Blechscherer
PL Nożyce do cięcia blachy
RUS Ножницы по металлу
CZ Nůžky na plech
H Lemezvágó olló
RO Foarfece pt. tablă
F Cisaille à tôle
I Cesole per lamiera
E Tijeras para chapas
CN 铁皮剪



SLIDING CARD



RIGHT CUT
CIECIE PRAWO

HRC 60-62

CrMo

90°

SERRATED EDGES
ZĄBKOWANA KRAWĘDZ
OSTRZY



YATO	L (mm)	cutting length (mm)	cutting capacities (mm)				6/36
			copper	cold-rolled steel	hard steel HRC35	stainless steel 304	
YT-1914	225	30	0.78	0.53	0.46	0.36	6/36

- GB Tin snips
- D Blechscherer
- PL Nożyce do cięcia blachy
- RUS Ножницы по металлу
- CZ Nůžky na plech
- H Lemezvágó olló
- RO Foarfece pt. tablă
- F Cisaille à tôle
- I Cesioie per lamiera
- E Tijeras para chapas
- CN 铁皮剪



SLIDING CARD



LEFT CUT
CIECIE
LEWE

DROP FORGED
KUTE

HRC 58-61

YATO	L (mm)	cutting length (mm)	cutting capacities (mm)				box
			copper	cold-rolled steel	hard steel HRC35	stainless steel 304	
YT-1900	260	30	0.94	0.78	0.60	0.45	6/24

- GB Tin snips
- CZ Nůžky na plech
- I Cesioie per lamiera
- D Blechscherer
- H Lemezvágó olló
- E Tijeras para chapas
- PL Nożyce do cięcia blachy
- RO Foarfece pt. tablă
- CN 铁皮剪
- RUS Ножницы по металлу
- F Cisaille à tôle

SLIDING CARD



RIGHT CUT
CIECIE
PRAWIE

DROP FORGED
KUTE

HRC 58-61



YATO	L (mm)	cutting length (mm)	cutting capacities (mm)				box
			copper	cold-rolled steel	hard steel HRC35	stainless steel 304	
YT-1901	260	30	0.94	0.78	0.60	0.45	6/24

YATO	L (mm)	cutting length (mm)	cutting capacities (mm)				box
			copper	cold-rolled steel	hard steel HRC35	stainless steel 304	
YT-1902	300	50	0.94	0.78	0.60	0.45	6/24

- GB Tin snips
- D Blechscherer
- PL Nożyce do cięcia blachy
- RUS Ножницы по металлу
- CZ Nůžky na plech
- H Lemezvágó olló
- RO Foarfece pt. tablă
- F Cisaille à tôle
- I Cesioie per lamiera
- E Tijeras para chapas
- CN 铁皮剪

SLIDING CARD



S55C
DROP FORGED
STEEL
STAL KUTA
NA ZMNO

HRC 55-60

HIGH FREQUENCY
HARDENING
HARTOWANIE
IMPULSOWE



YATO	L (mm)	cutting length (mm)	cutting capacities (mm)				box
			copper	cold-rolled steel	hard steel HRC35	stainless steel 304	
YT-1970	260	42	2.0	1.4	1.0	1.0	6/36

- GB Tin snips
- D Blechscherer
- PL Nożyce do cięcia blachy
- RUS Ножницы по металлу
- CZ Nůžky na plech
- H Lemezvágó olló
- RO Foarfece pt. tablă
- F Cisaille à tôle
- I Cesioie per lamiera
- E Tijeras para chapas
- CN 铁皮剪



SLIDING CARD



For cutting straight and tight curves left or right

HRC 58-61

YATO	L (mm)	cutting length (mm)	cutting capacities (mm)				box
			copper	cold-rolled steel	hard steel HRC35	stainless steel 304	
YT-1924	254	52	0.94	0.78	0.60	0.45	6/36

- GB Tin snips
- D Blechscherer
- PL Nożyce do cięcia blachy
- RUS Ножницы по металлу
- CZ Nůžky na plech
- H Lemezvágó olló
- RO Foarfece pt. tablă
- F Cisaille à tôle
- I Cesioie per lamiera
- E Tijeras para chapas
- CN 铁皮剪

SLIDING CARD



S55C
DROP FORGED
STEEL
STAL KUTA
NA ZMNO

HRC 55-60

HIGH FREQUENCY
HARDENING
HARTOWANIE
IMPULSOWE



YATO	L (mm)	cutting length (mm)	cutting capacities (mm)				box
			copper	cold-rolled steel	hard steel HRC35	stainless steel 304	
YT-1963	200	40	1.5	1.0	0.6	0.6	6/36
YT-1964	250	60	1.8	1.2	0.8	0.8	6/24
YT-1965	300	75	2.0	1.4	0.8	0.8	6/12

GB Metal sheet nibbler
D Blechnibbler
PL Nożyce matrycowe do blachy
RUS Ножницы для резки жести
CZ Nůžky na plech
H Lemezvágó olló

RO Foarfece pt. tablă
F Grignoteuse a tole
I Cesoia roditrice per lamiera
E Tijeras para chapas
CN 法式剪

260 mm
1 mm METAL PLATE BLACHA
1.2 mm ALUMINIUM COPPER ALUMINIUM WIRE
2 mm PLASTIC PLASTIK
Mn 65
3 mm CHANGEABLE CUTTING BLADES WYMIENNE OSTRAZKA

GB Spare blades for metal sheet nibbler
D Abbrechklingen für Blechnibbler
PL Ostrza zapasowe do nożyc matrycowych
RUS Лезвия для ножиц для резки жести
CZ Ostrí náhradní
H Tartalékpenge

RO Lame de rezervă
F Lame sécables pour grignoteuse a tole
I Lame di ricambio per cesoia roditrice per lamiera
E Cuchillas de recambio
CN 法式剪备用刀片

3 PCS
Mn 65



HALF DOUBLE BLISTER



SKIN CARD



for / dla:
YT-19260

YATO	L (mm)	
YT-19260	260	6/36

YATO	L (mm)	
YT-19261		10/100

GB Portable notchers
D Schere zum Ausschneiden von Ecken
PL Nożyce do wycinania naroży
RUS Ножницы для наружных углов
CZ Nůžky na vystřihování rohů
H Sarokkivágó olló

RO Foarfece pt. taierea colturilor
F Ciseaux pour le coupage des coins
I Cesoia per taglio reggetta in angoli
E Tijera para esquinas
CN 截角器

300 mm **90°**

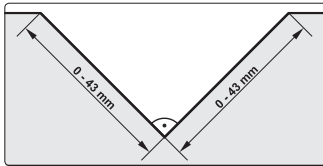
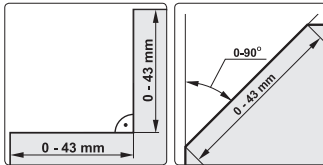

COLOR BOX



YATO	L (mm)	
YT-1939	300	15

GB Steel strap cutter
D Stahlgurtblechscher
PL Nożyce do cięcia taśmy stalowej
RUS Ножницы для резки стальной ленты
CZ Nůžky na plech
H Lemezvágó olló
RO Foarfece pt. tablă

F Cisaille à bande acier
I Cesoia per taglio reggetta in acciaio
E Tijeras para bandejas de acero
CN 钢带剪

SLIDING CARD



HRC 58-61

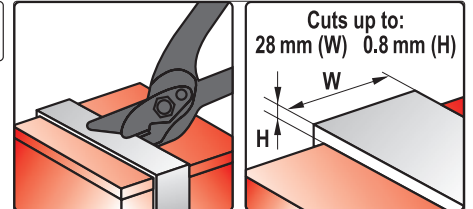

Cuts up to:
28 mm (W) 0.8 mm (H)



YATO	L (mm)	cutting length (mm)	cutting capacities (mm)				
YT-1930	305	28	copper	cold-rolled steel	hard steel HRC35	stainless steel 304	6/24

GB Bolt cutter
D Drahtschere
PL Nożyce do prętów
RUS Болторез
CZ Nůžky na tyče

H Kábelvágó olló
RO Foarfece pt. bare
F Cisaille pour barres
I Cesoie taglia bulloni

E Cortavarillas
CN 断线钳

HRC 56-61 **CrMo**



YATO	size / rozmiar	max. Ø (mm) soft / miękki	max. Ø (mm) medium / średnio twardy	
YT-1843	12" (300 mm)	5	4	20
YT-1844	14" (350 mm)	7	5	10
YT-1845	18" (450 mm)	8	6	10
YT-1846	24" (600 mm)	10	8	6
YT-1847	30" (750 mm)	13	10	4
YT-1848	36" (900 mm)	16	12	3

GB Bolt cutter
D Drahtschere
PL Nożyce do prętów
RUS Болторез

CZ Nůžky na tyče
H Kábelvágó olló
RO Foarfece pt. bare
F Cisaille pour barres

I Cesoie taglia bulloni
E Cortavarillas
CN 断线钳

CrMo



YATO	size / rozmiar	max. Ø (mm)	
YT-1851	14" (350 mm)	6	6/24
YT-1852	18" (450 mm)	7	6/12
YT-1853	24" (600 mm)	10	2/12
YT-1854	30" (750 mm)	12	6
YT-1855	36" (900 mm)	14	4
YT-1856	42" (1050 mm)	16	2

GB Hydraulic cutter
D Manueller Hydraulikschneider
PL Ręczny obcinak hydrauliczny
RUS Ручной гидравлический резак

CZ Rucni hydraulický odřezávac
H Kézi hydraulikus betonacélvágó
RO Cutit pt. retezat tevi
F Coupe manuelle hydraulique

I Cesoia idraulica manuale
E Cortadora hidráulica manual
CN 液压剪

BMC & COLOR SLEEVE



STEEL
STAL



YATO	cutting diameter / średnica cięcia (mm ²)	L (mm)	pressure / nacisk (T)	
YT-22870	4-12	320	6	5

YATO	cutting diameter / średnica cięcia (mm ²)	L (mm)	pressure / nacisk (T)	
YT-22871	4-16	430	8	5
YT-22872	4-20	515	13	3

GB Heads for hydraulic cutter
D Austauschmesser für Hydraulikschneider
PL Noże wymienne do obcinaka hydraulicznego
RUS Сменные ножи для гидравлического резака

CZ Vyměnitelné nože do hydraulického odřezávac
H Cserekés a hydraulikus betonacélvágóhoz
RO Lame schimbabile pt. cutit pt. retezat tevi
F Lame pour coupe manuelle hydraulique

I Teste per coltelli idraulici
E Cuchillas intercambiables para cortadora hidráulica
CN 液压钳钳口配件

2
PCS



SLIDING
CARD

YATO	for / dla	size / rozmiar (mm)	
YT-22873	YT-22870	12	10/100
YT-22874	YT-22871	16	10/100
YT-22875	YT-22872	20	10/100

10

GB Ratchet cable cutter
D Ratschenkabelschneider
PL Nożyce zapadkowe do kabli
RUS Кабелерез секторный

CZ Kleště na kabely, rohatka se západkou
H Racsnis kábelvágó
RO Cleste pt. taiat cablu cu clichet

F Cisailles à câbles
I Cricchetto taglia cavo
E Cortacables de carraca
CN 棘轮电缆剪

COLOR BOX



Cu/Al
CABLE
KABEL

60Si2Mn

HRC 50
CUTTING BLADE
OSTRZE TNAČE



YATO	cutting range / max. przekrój cięcia (mm ²)	max. Ø (mm)	L (mm)	
YT-18600	240	17.5	300	10

YATO	cutting range / max. przekrój cięcia (mm ²)	max. Ø (mm)	L (mm)	
YT-18602	380	22	380	10

GB Cable cutter
D Kabelschere
PL Nożyce do kabli
RUS Кабелерезы
CZ Elektrické upichovávky
H Kábelvágó
RO Patent tăietor pt. electrice
F Cisailles à câbles
I Cesoie per cavi
E Tijeras para cables
CN 电缆剪



STEEL
STAL

COLOR BOX



YATO	cutting range / max. przekrój cięcia (mm ²)	max. Ø (mm)	L (mm)	
YT-18610	125	12.5	370	20
YT-18611	250	18.0	580	10
YT-18612	500	25.0	770	5

GB Multi function scissors
D Multifunktionsmesser
PL Nożyce wielofunkcyjne
RUS Ножницы многофункциональные
CZ Víceúčelové nůžky
H Többfunkciós olló
RO Foarfece multifunctional
F Cisailles universelle
I Cesoie multifunzione
E Tijeras multifuncionales
CN 多用剪



65
mm

3Cr13
STAINLESS
STEEL
STAL
NIERZEWA

HRC
50-54

SLIDING
CARD

YATO	L (mm)	
YT-1976	65	12/72

- GB** Hand saw for wood
D Handsäge
PL Piła platnica do drewna
RUS Пила по дереву
CZ Pila na dřevno platnice
H Fafűrész, egyenes
RO Ferăstrău pt. lemn
F Scie
I Seghetto per legno
E Serrucho para madera
CN 手板锯

Mn 65
7T
inch
1.6 mm
0.9 mm
HRC 50-54



COLOR SLEEVE

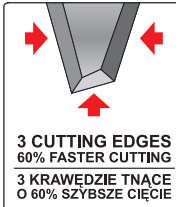

YATO	L (mm)	
YT-3101	400	12/48
YT-3102	450	10/40
YT-3103	500	10/40



PTFE
COATED
POWŁOKA

YATO	L (mm)	
YT-3106	400	12/48
YT-3107	450	10/40
YT-3108	500	10/40

- GB** Back saw
D Rückssäge
PL Piła grzbietnica
RUS Пила для стула
CZ Pila hřebenovka
H Kézifűrész
RO Ferăstrău coadă de vulpe
F Scie
I Segha con dorso
E Serrucho de costilla
CN 夹背锯

300 mm
Mn 65
12T
inch
1.2 mm
0.8 mm
HRC 50-54



COLOR SLEEVE



YATO	L (mm)	
YT-3130	300	12/60

- GB** Compass saw
D Stichsäge
PL Piła otwornica
RUS Выкружная пила
CZ Pila otvornice
H Lyukfűrész
RO Ferăstrău coadă de șoarece
F Scie étroite
I Segha a foretto
E Serrucho de punta
CN 鸡尾锯



300 mm
Mn 65
7T
inch
1.6 mm
0.9 mm
HRC 50-54

COLOR SLEEVE



YATO	L (mm)	
YT-3133	300	12/60

- GB** Wallboard saw
D Gipssäge
PL Piła do gipsów
RUS Ножовка по гипсокартону
CZ Pila na sádru
H Gipszfűrész
RO Ferăstrău pt. ghips
F Scie pour plaques de plâtre
I Segha per cartongesso
E Serrucho para cartón yeso
CN 墙板锯



COLOR SLEEVE



300 mm
Mn 65
7T
inch
160 mm
2.0 mm
1.5 mm
HRC 50-54

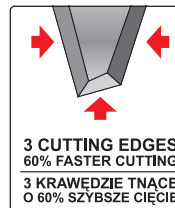

YATO	L (mm)	
YT-3134	150	12/60

- GB** Plastic mitre box with dovetail saw
D Kunststoffschneidladen mit Säge
PL Plastikowa skrzynka uciosowa z piłą
RUS Стуло пластмассовое с пилой
CZ Přípravek na řezání úhlu s pilkou
H Gėrbevágó műanyagláda hód farkú fűrészszel
RO Pasuitor + cutie
F Boîte à onglets + scie
I Taglia cornici in plastica con sega
E Guía de ingletar y sierra
CN 燕尾锯



350 mm
Mn 65
HRC 50-54
1.2 mm
0.8 mm
12T
inch
ABS
300x140
x70mm

COLOR
BOX



YATO	L (mm)	
YT-3150	350	10

- GB** Bow saw
D Bügelsäge
PL Pila kabłąkowa
RUS Лучковая пила
CZ Oblouková pila
H Keretes fűrész
RO Ferăstrău de curbură
- F** Scie à bûches
I Sega ad arco
E Sierra de arco
CN 两用弓锯

COLOR SLEEVE



HCS 65



FOR WOOD
DO DREWNA



2
FUNCTION

FOR WOOD AND METAL
DO DREWNA I METALU

YATO	L (mm)	
YT-3200	300	12/24

YATO	L (mm)	
YT-3201	450	12/24
YT-3202	530	
YT-3203	610	
YT-3204	760	

- GB** Blade for dry wood
D Trockenholzsägeblatt für Handsäge
PL Brzeszczot do drewna suchego
RUS Лезвие для работы по сухому дереву
CZ Pilový list na suché dřevo
- H** Fűrészlap száraz fához
RO Lama pt. lemn uscat
F Lame à bois sec
I Lama per il legno secco
E Hoja de sierra para madera seca
CN 干木锯条

HCS 65

DRY WOOD
DREWNO SUCHE

HCS 65

WET WOOD
DREWNO MOKRE



COLOR SLEEVE

YATO	L (mm)	
YT-3221	450	50/200
YT-3222	530	
YT-3223	610	
YT-3224	760	

- GB** Blade for wet wood
D Nassholzsägeblatt für Handsäge
PL Brzeszczot do drewna mokrego
RUS Лезвие для работы по влажному дереву
CZ Pilový list na mokré dřevo
- H** Fűrészlap nedves fához
RO Lama pt. lemn verde
F Lame à bois humide
I Lama per il legno bagnato
E Hoja de sierra para madera mojada
CN 湿木锯条



COLOR SLEEVE

YATO	L (mm)	
YT-3230	300	50/200
YT-3231	450	
YT-3232	530	
YT-3233	610	
YT-3234	760	

- GB** Hacksaw frame
D Metallbogensäge
PL Pila do metalu
- RUS** Пила по металлу
CZ Pilka na železo
H Fémfűrész
- RO** Ferăstrău cu cadru metalic
F Scie à métal
- I** Seghetto per metallo
E Sierra de metalo
CN 锯架

COLOR SLEEVE



BI-METAL

24 TPI

FOR METAL DO METALU



YATO	L (mm)	
YT-3160	300	10



YATO	L (mm)	
YT-3161	300	6/36



YATO	L (mm)	
YT-3163	300	5/20

- GB** Hacksaw frame blade
D Metallsägeblatt
PL Brzeszczot do metalu
- RUS** Полотна по металлу
CZ Pilový list na kovy
H Fémfűrész lap
- RO** Panza fierastrau pt. metal
F Lame à métal
I Lama per metallo
- E** Hoja de sierra para metalo
CN 锯条

300 mm

12 mm

24 TPI



PLASTIC HANGER

YATO	L (mm)	W (mm)	TPI	PCS packing	
YT-3460	300	12	24	5	10/200

BI-METAL M2+6150

YATO	L (mm)	W (mm)	TPI	PCS packing	
YT-3461	300	12	24	2	20/500

BI-METAL M2+Co8%

YATO	L (mm)	W (mm)	TPI	PCS packing	
YT-3462	300	12	24	2	20/500

GB Half-moon saw blade for oscillating multitool HSS
D Rundes Sägeblatt HSS für ein Multifunktionswerkzeug
PL Brzeszczot okrągły HSS do narzędzia wielofunkcyjnego
RUS Диское полотно HSS для многофункционального инструмента
CZ Segmentový pilový list HSS pro multifunkční nářadí
H HSS kör keresztmetszetű fűrészlap multifunkciós szerszámhoz
RO Lamă rotundă HSS pt. unealta multifuncțională
F Lame segment HSS pour outil multifonction
I Lama di sega circolare per lo strumento multi-funzione HSS
E Hoja redonda HSS para herramienta multifuncional
CN 高速钢半圆形锯片



88 mm

HSS

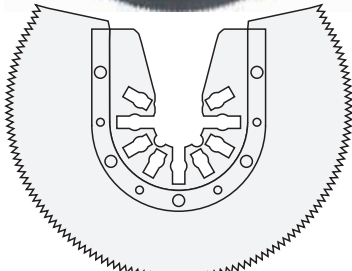

• application:
wood, plastic, soft metal, plaster
 • zastosowanie:
drewno, plastik, miękki metal, gips

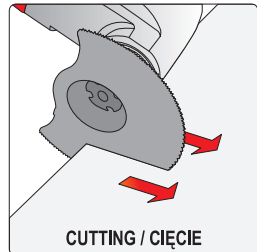

CUTTING / CIĘCIE

for / dla: YT-82220, YT-82223,
YT-82818, YT-82900

YATO
YT-34680

5/100

GB Half-moon saw blade for oscillating multitool HCS
D Rundes Sägeblatt HCS für ein Multifunktionswerkzeug
PL Brzeszczot okrągły HCS do narzędzia wielofunkcyjnego
RUS Диское полотно HCS для многофункционального инструмента
CZ Segmentový pilový list HCS pro multifunkční nářadí
H HCS kör keresztmetszetű fűrészlap multifunkciós szerszámhoz
RO Lamă rotundă HCS pt. unealta multifuncțională
F Lame segment HCS pour outil multifonction
I Lama di sega circolare per lo strumento multi-funzione HCS
E Hoja redonda HCS para herramienta multifuncional
CN 高碳钢扇形锯片

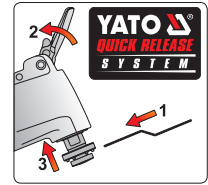

88 mm

HCS

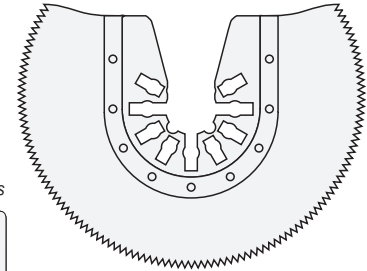

• application:
wood, plastic, soft metal, plaster
 • zastosowanie:
drewno, plastik, miękki metal, gips

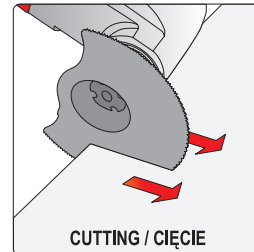

CUTTING / CIĘCIE

for / dla: YT-82220, YT-82223,
YT-82818, YT-82900

YATO
YT-34681

5/100

10

GB Brazed carbide d-shape blade for oscillating multitool HM
D Rundes Sägeblatt HM für ein Multifunktionswerkzeug
PL Brzeszczot okrągły HM do narzędzia wielofunkcyjnego
RUS Диское полотно HM для многофункционального инструмента
CZ Segmentový pilový list HM pro multifunkční nářadí
H HM kör keresztmetszetű fűrészlap multifunkciós szerszámhoz
RO Lamă rotundă HM pt. unealta multifuncțională
F Lame segment HM pour outil multifonction
I Lama di sega circolare per lo strumento multi-funzione HM
E Hoja redonda HM para herramienta multifuncional
CN D形合金磨片

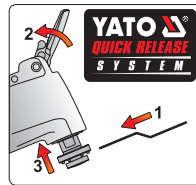

70 mm

HM

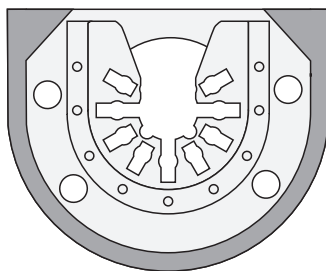

• application:
concrete, ceramic materials,
epoxy resin, fibreglass
 • zastosowanie:
beton, materiały ceramiczne,
żywica epoksydowa, włókno szklane

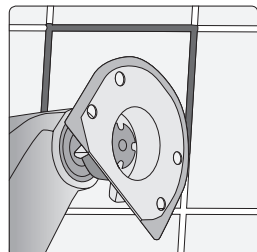

CUTTING / CIĘCIE

for / dla: YT-82220, YT-82223,
YT-82818, YT-82900

YATO
YT-34682

5/100

GB Plunge cutting saw blade for oscillating multitool BIM
D Tiefenmesser BIM für ein Multifunktionswerkzeug
PL Brzeszczot wgłębny BIM do narzędzia wielofunkcyjnego
RUS Сабельное полотно BIM для многофункционального инструмента
CZ Pilový list BIM na ponorné řezy pro multifunkční nářadí
H BIM merülő fűrészlap multifunkciós szerszámhoz
RO Lamă de adâncime BIM pt. unealta multifuncțională
F Lame scie plongeante BIM pour outil multifonction
I Lama per tagli dal pieno BIM
E Hoja para cortes profundos BIM para herramienta multifuncional
CN 双金属直锯片

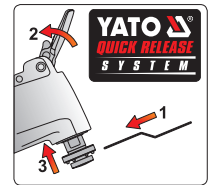

10 mm

BIM

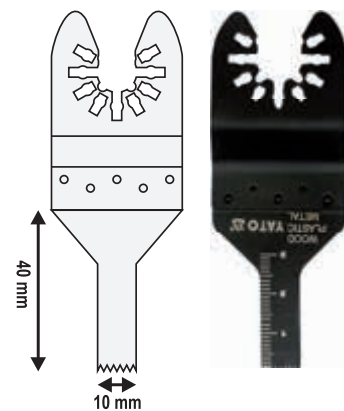

• application:
wood, plastic, metal, plaster,
epoxy resin
 • zastosowanie:
drewno, plastik, metal, gips,
żywica epoksydowa

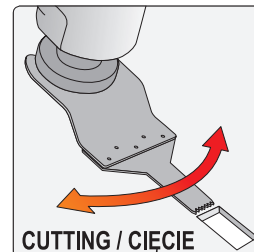

CUTTING / CIĘCIE

for / dla: YT-82220, YT-82223,
YT-82818, YT-82900

YATO
YT-34683

5/100

GB Plunge cutting saw blade for oscillating multitool BIM
D Tiefenmesser BIM für ein Multifunktionswerkzeug
PL Brzeszczot węglenny BIM do narzędzia wielofunkcyjnego
RUS Сабельное полотно BIM для многофункционального инструмента
CZ Pilový list BIM na ponorné řezy pro multifunkční nářadí
H BIM merülő fűrészlap multifunkciós szerszámhoz
RO Lamă de adâncime BIM pt. unealta multifuncțională
F Lame scie plongeante BIM pour outil multifonction
I Lama per tagli dal pieno BIM
E Hoja para cortes profundos BIM para herramienta multifuncional
CN 双金属直锯片

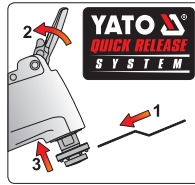

3
PCS
28.5
mm
BIM

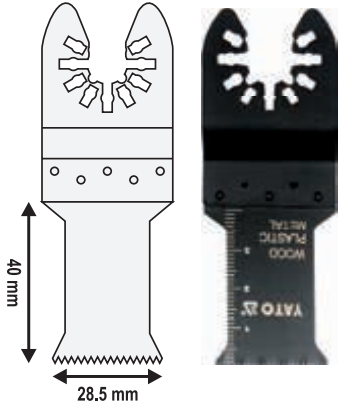

- application: wood, plastic, metal, plaster, epoxy resin
- zastosowanie: drewno, plastik, metal, gips, żywica epoksydowa

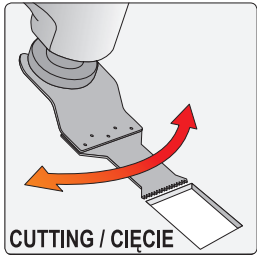

for / dla: YT-82220, YT-82223, YT-82818, YT-82900

YATO
YT-34684 5/100



GB Plunge cutting saw blade for oscillating multitool HCS
D Tiefenmesser HCS für ein Multifunktionswerkzeug
PL Brzeszczot węglenny HCS do narzędzia wielofunkcyjnego
RUS Сабельное полотно HCS для многофункционального инструмента
CZ Pilový list HCS na ponorné řezy pro multifunkční nářadí
H HCS merülő fűrészlap multifunkciós szerszámhoz
RO Lamă de adâncime HCS pt. unealta multifuncțională
F Lame scie plongeante HCS pour outil multifonction
I Lama per tagli dal pieno HCS
E Hoja para cortes profundos HCS para herramienta multifuncional
CN 高碳钢直锯片

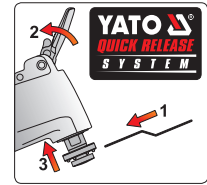

3
PCS
34
mm
HCS

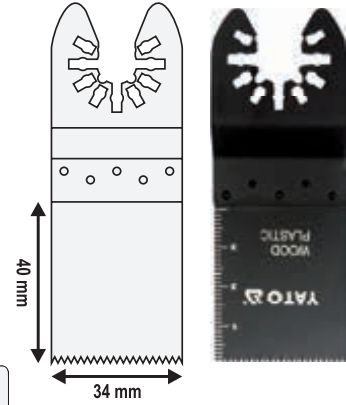

- application: wood, plastic, plaster
- zastosowanie: drewno, plastik, gips

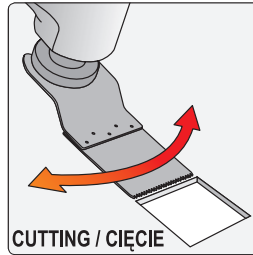

for / dla: YT-82220, YT-82223, YT-82818, YT-82900

YATO
YT-34685 5/100



GB Plunge cutting saw blade for oscillating multitool BIM
D Tiefenmesser BIM für ein Multifunktionswerkzeug
PL Brzeszczot węglenny BIM do narzędzia wielofunkcyjnego
RUS Сабельное полотно BIM для многофункционального инструмента
CZ Pilový list BIM na ponorné řezy pro multifunkční nářadí
H BIM merülő fűrészlap multifunkciós szerszámhoz
RO Lamă de adâncime BIM pt. unealta multifuncțională
F Lame scie plongeante BIM pour outil multifonction
I Lama per tagli dal pieno BIM
E Hoja para cortes profundos BIM para herramienta multifuncional
CN 双金属直锯片

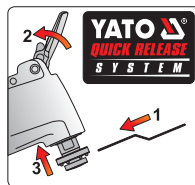

20
mm
BIM

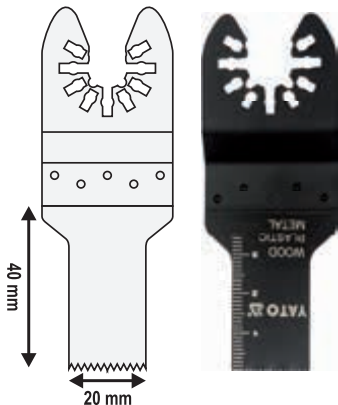

- application: wood, plastic, metal, plaster, epoxy resin
- zastosowanie: drewno, plastik, metal, gips, żywica epoksydowa

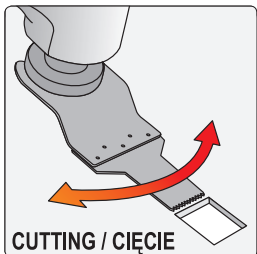

for / dla: YT-82220, YT-82223, YT-82818, YT-82900

YATO
YT-34686 5/100



GB Brazed carbide triangular rasp for oscillating multitool
D Dreieckige Raspel für ein Multifunktionswerkzeug
PL Tamik trójkątny do narzędzia wielofunkcyjnego
RUS Треугольный рашпиль для многофункционального инструмента
CZ Trojúhelníková brusná deska pro multifunkční nářadí
H Háromszög keresztmetszetű reszelő multifunkciós szerszámhoz
RO Rașpel triunghiular pt. unealta multifuncțională
F Plateau de ponçage à concretion carbure pour outil multifonction
I Raspa in metallo duro forma triangolare multi-funzione
E Escofina triangular para herramienta multifuncional
CN 三角形嵌合金磨片

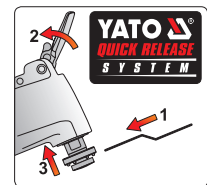

80
mm
HM

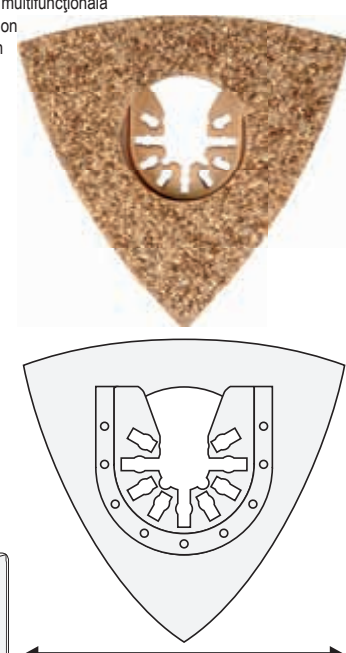

- application: concrete, ceramic materials
- zastosowanie: beton, materiały ceramiczne

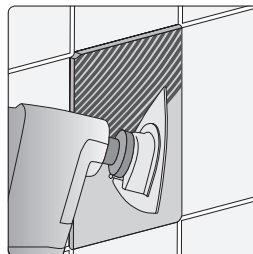

for / dla: YT-82220, YT-82223, YT-82818, YT-82900

YATO
YT-34687 5/100



- GB Short scraper for oscillating multitool
- D Schaber für ein Multifunktionswerkzeug
- PL Skrobak do narzędzia wielofunkcyjnego
- RUS Скребок для многофункционального инструмента
- CZ Škrabka pro multifunkční nářadí
- H Kaparó multifunkciós szerszámhoz
- RO Răzuitor pt. unealta multifuncțională
- F Spatule pour outil multifonction
- I Raschietto oscillante multifunzione adatto
- E Raspador para herramienta multifuncional
- CN 弯刮刀

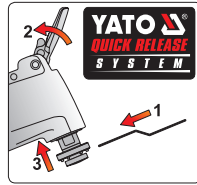

52 mm

HCS



• application:
paint, adhesives,
sealing compounds

• zastosowanie:
farby, kleje, masy uszczelniające

52 mm

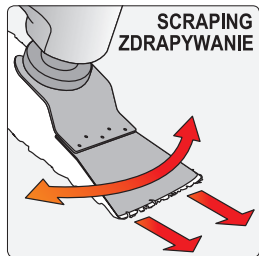

SCRAPING
ZDRAPYWANIE

DOUBLE
BLISTER

for / dla: YT-82220, YT-82223,
YT-82818, YT-82900



5/100

- GB Triangular eva sanding pad for oscillating multitool
- D Schleiffuß für ein Multifunktionswerkzeug
- PL Stopa szlifierska do narzędzia wielofunkcyjnego
- RUS Шлифовальная насадка для многофункционального инструмента
- CZ Brusný nástavec pro multifunkční nářadí
- H Csiszoló talp multifunkciós szerszámhoz
- RO Picior de sablare pt. unealta multifuncțională
- F Plateau de ponçage pour outil multifonction
- I Tasso di smerigliatrice multifunzionale
- E Pie de rectificación para herramienta multifuncional
- CN 三角砂盘



90 mm

EVA



• application:
wood, metal, plaster

• zastosowanie:
drewno, metal, gips

90 mm

for / dla: YT-82220, YT-82223,
YT-82818, YT-82900



5/100



SANDING / SZLIFOWANIE

DOUBLE
BLISTER

- GB Triangular sand paper for oscillating multitool
- D Schleifpapier für ein Multifunktionswerkzeug
- PL Papier ścierny do narzędzia wielofunkcyjnego
- RUS Шлифовальная бумага для многофункционального инструмента
- CZ Brusné plátno pro multifunkční nářadí
- H Csiszolópapír multifunkciós szerszámhoz
- RO Hârtie abrazivă pt. unealta multifuncțională
- F Feuilles abrasives pour outil multifonction
- I Carta abrasiva per utensile multifunzione
- E Papel de lija para herramienta multifuncional
- CN 三角砂纸

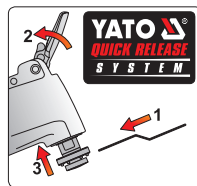

10 mm



• application:
wood, metal, plaster

• zastosowanie:
drewno, metal, gips

90 mm

for / dla: YT-82220, YT-82223,
YT-82818, YT-82900



5/100



SANDING / SZLIFOWANIE

DOUBLE
BLISTER

- GB Accessories set for oscillating multitool
- D Zubehörsatz für ein Multifunktionswerkzeug
- PL Zestaw akcesoriów do narzędzia wielofunkcyjnego
- RUS Набор принадлежностей для многофункционального инструмента
- CZ Souprava příslušenství pro multifunkční nářadí
- H Tartozék szett multifunkciós szerszámhoz
- RO Set de accesorii pt. unealta multifuncțională
- F Set d'accessoires pour outil multifonction
- I Set di accessori per utensile multifunzione
- E Juego de accesorios para herramienta multifuncional
- CN 三件套：双金属直锯片 + 高碳钢直锯片 + 高速钢半圆形锯片

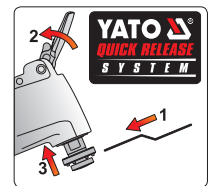

3 PCS HSS

HCS BIM

• application:
wood, plastic,
metal, plaster,
epoxy resin

• zastosowanie:
drewno, plastik,
metal, gips,
żywica epoksydowa

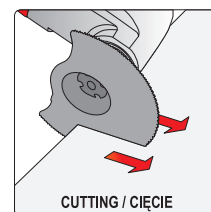
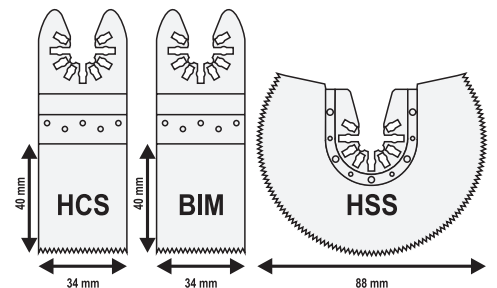

CUTTING / CIĘCIE

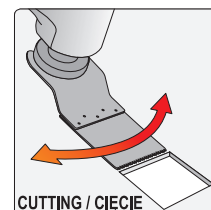

CUTTING / CIĘCIE

for / dla: YT-82220, YT-82223,
YT-82818, YT-82900



5/100

DOUBLE
BLISTER

GB Steel wire brush
D Stahldrahtbürste
PL Szczotka druciana

RUS Щетка стальная
CZ Drátěný kartáč
H Drótkefe

RO Perie de sârmă
F Brosse de fil en laiton
I Spazzola metallica

E Cepillo de acero
CN 钢丝刷



ZINC
PLATED
WIRES

YATO	rows / rzędy	
YT-6353	3	12/120
YT-6354	4	12/120
YT-6355	5	12/120
YT-6356	6	12/120

YATO	rows / rzędy	
YT-6358	4	12/72
YT-6359	5	12/72
YT-6360	6	12/72

GB Steel wire brush
D Stahldrahtbürste
PL Szczotka druciana
RUS Щетка стальная
CZ Drátěný kartáč
H Drótkefe
RO Perie de sârmă
F Brosse de fil en laiton
I Spazzola metallica
E Cepillo de acero
CN 钢丝刷

TIED
ON CARD



YATO	rows / rzędy	L (mm)	
YT-6330	3	340	12/72

YATO	rows / rzędy	L (mm)	
YT-6331	3	340	12/72



YATO	rows / rzędy	L (mm)	
YT-6332	4	260	12/72

YATO	rows / rzędy	L (mm)	
YT-6333	4	290	12/72

YATO	rows / rzędy	L (mm)	
YT-6334	6	180x65	12/60



YATO	rows / rzędy	L (mm)	
YT-6335	3	340	12/72

YATO	rows / rzędy	L (mm)	
YT-6336	3	340	12/72

YATO	rows / rzędy	L (mm)	
YT-6337	3	180	24/144



YATO	rows / rzędy	L (mm)	
YT-6338	4	260	12/72

YATO	rows / rzędy	L (mm)	
YT-6339	4	290	12/72

YATO	rows / rzędy	L (mm)	
YT-6340	5	180	24/120



YATO	rows / rzędy	L (mm)	
YT-6341	3	340	12/72

YATO	rows / rzędy	L (mm)	
YT-6343	3	180	24/144

YATO	rows / rzędy	L (mm)	
YT-6344	4	260	12/72



YATO	rows / rzędy	L (mm)	
YT-6345	4	290	12/72

YATO	rows / rzędy	L (mm)	
YT-6346	5	180	24/120

YATO	rows / rzędy	L (mm)	
YT-6349	5	180	24/120

GB Plastic handle wire brush set
D Bürstensatz
PL Komplet szczotek drucianych
RUS Щетки - набор
CZ Drátěný kartáče
H Kefekészlet
RO Perii
F Set de brosse de fil en laiton
I Set di spazzole metalliche
E Juego de 3 cepillos
CN 钢丝刷组套

SLIDING
CARD



3
PCS
STAINLESS
STEEL
STAL
NERDZEWNA
BRASS
MOSIĄDZ
NYLON



YATO	rows / rzędy	L (mm)	
YT-6351	3	180	24/144

- GB Wire brush set
- D Bürsten Sortiment
- PL Zestaw szczotek do gniazd wtryskiwaczy
- RUS Ерши с наружной резьбой в наборе
- CZ Rourové kartáče válcové
- H Henger drótkefe
- RO Perii cilindrice pt. curatarea gaurilor
- F Brosse cylindrique
- I Vetro di protezione
- E Cepillos para limpieza interior
- CN 件套清洁组



20 PCS	150 mm	1/4" 6.3mm	9,11,13 15,17,19 mm
NYLON	STAINLESS STEEL DRUT ZE STALI NIEODZEWNI	BRASS MOSIADZ	

NYLON CASE & COLOR BOX

YATO	
YT-08195	24

- GB Copper pipe internal brush
- D Kupferrohr Innenbürste
- PL Szczotka wewnętrzna do rur miedzianych
- RUS Щетка для внутренней очистки труб
- CZ Kartáč vnitřní na měděné trubky
- H Rézcső belső tisztító kefe

- RO Perii de interior pt. tevi de cupru
- F Brosse aux tubes en cuivre
- I Spazzola per il rame interno
- E Cepillo para limpieza de tubos de cobre
- CN 管子刷

STAINLESS
STEEL WIRE
DRUT ZE STALI
NIEODZEWNI



YATO	Ø (mm)	
YT-63701	15	12/120
YT-63702	18	12/120
YT-63703	22	12/120
YT-63704	28	12/120

- GB Copper pipe brush 2 in 1
- D 2-in-1 Kupferrohrbürste für Innen- und Außenreinigung
- PL Szczotka do rur miedzianych 2 w 1
- RUS Щетка для внутренней и внешней зачистки медных труб
- CZ Kartáč vnitřní a vnější na měděné trubky

- H Rézcső tisztító kefe 2 in 1
- RO Perii pt. tevi de cupru 2 in 1
- F Brosse aux tubes en cuivre
- I Spazzola per i tubi di rame 2 in 1
- E 2-en-1 cepillo para limpieza de tubos de cobre int. y ext
- CN 2合1管子刷

STAINLESS
STEEL WIRE
DRUT ZE STALI
NIEODZEWNI

SLIDING
CARD



YATO	Ø (mm)	
YT-63705	15; 22	50/100

- GB Cleaning pad set for copper pipes
- D Reinigungsvlies-satz für Kupferrohre
- PL Włóknina do czyszczenia rur miedzianych
- RUS Губка абразивная
- CZ Brusné rouno
- H Tisztítószivacs
- RO Burete abraziv
- F Tampons de nettoyage
- I Fibra abrasiva per la pulizia de tubo di rame
- E Almohadilla abrasiva
- CN 件套工业洁

COLOR
SLEEVE



10 PCS	75x130 mm	FOR PIPES DO RUR Cu
METAL FREE NIE ZAWIERA METALU	DRY WORK PRACA NA SUCHO	WET WORK PRACA NA MOKRO

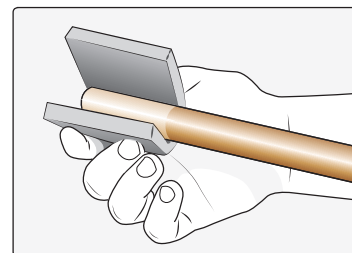

YATO	size / rozmiar (mm)	
YT-63740	75x130	50

- GB Cup brush with shaft
- D Stahldraht-Topfbürste
- PL Szczotka czolowa z trzpieniem
- RUS Щетка "чашка" со стержнем
- CZ Čelní kartáč drátěný se stopkou
- H Homlok drótkefe, nyéllel
- RO Perie frontală pt. bormasina
- F Brosse coupe avec gouppille
- I Spazzola a tazza
- E Cepillo de copa con mandril
- CN 钢丝轮

SLIDING
CARD



Ø 6 mm



INOX



YATO	Ø (mm)	R.P.M.max.	
YT-4750	75	4500	12/96

YATO	Ø (mm)	R.P.M.max.	
YT-4751	75	4500	12/96

YATO	Ø (mm)	R.P.M.max.	
YT-4752	75	6000	12/72

- GB Cup brush with shaft set
- D Drahtbürste mit Einspannschaft
- PL Szczotki druciane z trzpieniem
- RUS Щетки проволочные со стержнем
- CZ Drátěný kartáč se stopkou
- H Drótkefe, csapos
- RO Perii de sârmă cu tijă
- F Set de brosses coupe avec gouppille
- I Spazzola metallica a disco
- E Cepillos de alambre con espiga
- CN 三件钢丝组套



SLIDING
CARD



Ø 6 mm

YATO	Ø (mm)	R.P.M.max.	
YT-4755	20	6000	12/60
	50	7500	
	50	4500	

GB Circular brush with shaft
D Stahldraht-Scheibenbürste
PL Szczotka tarczowa z trzpieniem

RUS Щетка круговая со стержнем
CZ Okružní kartáč drátěný se stopkou
H Tarcás drótkefe, nyéllel

RO Perie rotunda pt. bormasina
F Brosse circulaire avec gouppile
I Spazzola a disco

E Cepillo redondo
CN 钢丝轮

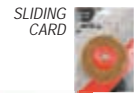

INOX



YATO	Ø (mm)	R.P.M.max.	Box
YT-4757	100	4500	12/96

YATO	Ø (mm)	R.P.M.max.	Box
YT-4758	100	4500	12/96

YATO	Ø (mm)	R.P.M.max.	Box
YT-4759	75	20000	10/100

GB Circular brush
D Stahldraht-Scheibenbürste
PL Szczotka tarczowa z gwintem

RUS Щетка круговая
CZ Okružní kartáč drátěný
H Tarcás drótkefe

RO Perie rotunda pt. bormasina
F Brosse circulaire avec filet
I Spazzola conica

E Cepillo redondo
CN 钢丝轮



M14



INOX



YATO	Ø (mm)	R.P.M.max.	Box
YT-4761	100	12500	8/64

YATO	Ø (mm)	R.P.M.max.	Box
YT-4763	100	12500	8/64

YATO	Ø (mm)	R.P.M.max.	Box
YT-4764	125	10000	8/48

GB Cup brush
D Stahldraht-Topfbürste
PL Szczotka czolowa z gwintem

RUS Щетка "чашка"
CZ Čelní kartáč drátěný
H Homlok drótkefe

RO Perie frontală
F Brosse coupe avec filet
I Spazzola conica

E Cepillo de copa
CN 钢丝轮



M14



INOX



YATO	Ø (mm)	R.P.M.max.	Box
YT-4766	100	8500	4/32

YATO	Ø (mm)	R.P.M.max.	Box
YT-4767	60	12500	10/80

YATO	Ø (mm)	R.P.M.max.	Box
YT-4768	75	11000	6/36

YATO	Ø (mm)	R.P.M.max.	Box
YT-4769	100	8500	4/16

GB Insulated cable knife
D Kabelmesser gerade
PL Nóż dla elektryków izolowany
RUS Нож кабельный изолированный
CZ Izolovaný nůž
H Szerelőkés

RO Cutit pt. cabluri izolat
F Couteau d'électricien
I Coltello per elettricisti isolato
E Cuchillo electricista aislante
CN 绝缘电工刀

180 mm

50 mm

65 Mn

1000 V



POLYBAG



1000V VDE CERTIFICATE EN 60900:2012

YATO	L (mm)	Box
YT-21210	180	6/72

GB Insulated dismantling knife
D Abmantelungsmesser
PL Nóż demontażowy dla elektryków
RUS Нож кабельный изолированный
CZ Zahnutý nůž s vodítkem, izolovaný

H Szerelőkés
RO Cutit demontabil izolat
F Couteau d'électricien
I Coltello di smontaggio per elettricisti isolati
E Cuchillo de desmontaje aislante
CN 绝缘电工刀

155 mm

38 mm

65 Mn

1000 V



POLYBAG



1000V VDE CERTIFICATE EN 60900:2012

YATO	L (mm)	Box
YT-21211	155	6/72

GB Electrician's knife
D Montagemeser
PL Nóż składany monterski
RUS Нож складной

CZ Montážní nůž
H Szerelőkés
RO Cutit pt. decablat
F Couteau d'électricien

I Coltello
E Cuchillo de montaje
CN 电工刀



3CR13

HRC 42-48

85 mm

200 mm



75 mm

190 mm



YATO	L (mm)	Box
YT-7600	200	6/96

YATO	L (mm)	Box
YT-7601	190	6/96

GB Folding knife with bits
D Klappmesser
PL Nóż składany z bitami
RUS Нож складной

CZ Kapesní nůž
H Zsebkés
RO Briceag

F Couteau pince multifonction avec embouts
I Coltello pieghevole con punte

E Navaja
CN 旋具头折叠刀

BLISTER CARD



STAINLESS STEEL
 STAL
 NERDZEWNIA

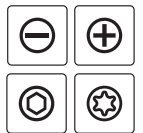

□ 3, 4 mm; ○ 3, 4 mm;
 ⊕ PH1, PH2; ⊗ T10, T20

YATO
 YT-76031 6/48

GB Folding knife
D Klappmesser
PL Nóż składany
RUS Нож складной

CZ Kapesní nůž
H Zsebkés
RO Briceag
F Couteau pliant

I Coltello pieghevole
E Navaja
CN 折叠刀

SLIDING CARD

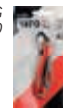

AI



STAINLESS STEEL BLADE
 OSTRZE ZE STALI
 NERDZEWNIA

YATO
 YT-76050 12/72



YATO
 YT-76051 12/120



YATO
 YT-76052 6/48

GB Multi knife
D Klappmesser
PL Nóż wielofunkcyjny
RUS Нож складной
CZ Kapesní nůž
H Zsebkés
RO Briceag

F Couteau multifonction
I Pinze universale
E Navaja
CN 多功能折叠刀

7
 PCS

STAINLESS STEEL
 STAL
 NERDZEWNIA

AI



SLIDING CARD



YATO
 YT-76030 12/96

GB Multi knife
D Klappmesser
PL Narzędzie wielofunkcyjne
RUS Нож складной
CZ Kapesní nůž
H Zsebkés
RO Briceag

F Couteau pince multifonction
I Pinze universale
E Navaja
CN 多功能折叠刀



BLISTER CARD

9
 PCS

STAINLESS STEEL
 STAL
 NERDZEWNIA

AI



AI



YATO
 YT-76040 10/100

YATO
 YT-76041 12/48

GB Multi knife
D Klappmesser
PL Narzędzie
wielofunkcyjne
RUS Нож складной

CZ Kapesní nůž
H Zsebkés
RO Briceag
F Couteau pince
multifonction

I Pinze universale
E Navaja
CN 多功能折叠刀

BLISTER
CARD

9
PCS

STAINLESS
STEEL
STAL
NIEZŻELAZNA



AI



YATO
YT-76042 12/48

YATO
YT-76043 6/36

GB Cutter knife
D Universalmesser
PL Nożyk z ostrzem trapezowym
RUS Ножи универсальные

CZ Univerzální nůž
H Univerzális kés
RO Cuțit universal

F Couteau lames trapézoïdale
I Coltellino con lama trapezoidale

E Cutter con filo trapezoidal
CN 实用刀

SK5



x5

x5

YATO
YT-7532 61x33x0.5 12/72

YATO
YT-7534 61x33x0.5 12/72

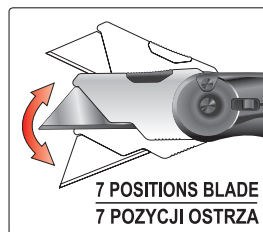

AI LOCK
BLOKADA



YATO
YT-76060 61x33x0.5 6/48



x3

YATO
YT-7520 61x33x0.5 6/48

LOCK
BLOKADA

YATO
YT-76061 61x33x0.5 6/48



1+3 Zn TPR ABS AUTO RETRACTABLE AUTOMATYCZNIE CHOWANA OSTRZA MULTI-STOP 3 POZYCJE WYSUWANIA



YATO
YT-75201 61x33x0.5 12/144



GB Utility knife
 D Universalmesser
 PL Nożyk z łamany ostrzem
 RUS Нож универсальный
 CZ Nůž na tapety
 H Tapétaolló

RO Cuțitaș pt. tapet
 F Cutter à lames sécables
 I Taglierino
 E Cuchillo para papel de empapelar
 CN 美工刀



SLIDING CARD

1+2 ABS TPR AUTO LOCK BLOKADA METAL SLIDING BAR METALOWA PROWADNICA SELF LOADING AUTOMATYCZNA WYBIJANA OSTRZA SK5

YATO	(mm)	
YT-75001	9x0.4	12/144



DOUBLE BLISTER

1+3 Zn max.20kg BLADE PULL FORCE SEKA WYCIĄGANIA OSTRZA AUTO LOCK BLOKADA METAL SLIDING BAR METALOWA PROWADNICA BLADE STABILIZATION STABILIZACJA OSTRZA SELF LOADING AUTOMATYCZNA WYBIJANA OSTRZA SK5

YATO	(mm)	
YT-75811	18x0.5	12/144



SLIDING CARD

X3 AL HANDLE SK5

YATO	(mm)	
YT-7581	18x0.4	20/80



SLIDING CARD

Zn TPR ABS max.20kg BLADE PULL FORCE SEKA WYCIĄGANIA OSTRZA AUTO LOCK BLOKADA METAL SLIDING BAR METALOWA PROWADNICA SK5

YATO	(mm)	
YT-75121	18x0.5	12/144



SLIDING CARD

Zn TPR max.20kg BLADE PULL FORCE SEKA WYCIĄGANIA OSTRZA AUTO LOCK BLOKADA METAL SLIDING BAR METALOWA PROWADNICA SK5

YATO	(mm)	
YT-75122	18x0.5	12/144

10



SLIDING CARD

SK2

YATO	(mm)	
YT-7511	9x0.4	24/288
YT-7512	18x0.5	12/96



SLIDING CARD

ABS TPR LOCK SK2

YATO	(mm)	
YT-7506	9x0.4	24/240
YT-7507	18x0.5	12/144



SLIDING CARD

ABS TPR max.20kg BLADE PULL FORCE SEKA WYCIĄGANIA OSTRZA AUTO LOCK BLOKADA METAL SLIDING BAR METALOWA PROWADNICA SK5

YATO	(mm)	
YT-75071	18x0.5	12/144



SLIDING CARD

ABS TPR max.20kg BLADE PULL FORCE SEKA WYCIĄGANIA OSTRZA AUTO LOCK BLOKADA METAL SLIDING BAR METALOWA PROWADNICA SK5

YATO	(mm)	
YT-75072	18x0.5	12/144



SLIDING CARD

ABS SK2

YATO	(mm)	
YT-7504	9x0.4	24/240
YT-7505	18x0.5	24/240



SLIDING CARD

ABS TPR max.20kg BLADE PULL FORCE SEKA WYCIĄGANIA OSTRZA AUTO LOCK BLOKADA METAL SLIDING BAR METALOWA PROWADNICA SK5

YATO	(mm)	
YT-75101	25x0.7	12/144

GB Spare blades
 D Abbrechklingen
 PL Ostrza zapasowe
 RUS Лезвия для универсальных ножей
 CZ Lomené ostrí náhradní
 H Törhető tartalékpenge

RO Lame de rezervă rupte
 F Lame sécables pour le cutter
 I Lame di ricambio
 E Filo partido de recambio
 CN 美工刀刀片

PLASTIC BOX & SLIDING CARD



10 PCS



YATO	(mm)	
YT-7530	25x0.7	6/48



YATO	(mm)	
YT-7528	9x0.4	24/144
YT-7529	18x0.5	24/144



YATO	(mm)	
YT-7531	61x33x0.5	24/144



YATO	(mm)	
YT-7524	9x0.4	24/240
YT-7525	18x0.5	24/144

- GB** Insulated electrician scissors
D Elektrische Schere
PL Nożyczki dla elektryków izolowane
RUS Ножницы диэлектрические универсальные
CZ Elektrické nůžky
H Univerzális olló
RO Foarfece - electrician izolate
F Ciseaux pour electriciens
I Forbici per elettricisti
E Tijeras eléctricos
CN 绝缘电工剪

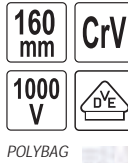

1000V VDE CERTIFICATE EN 60900:2012

YATO	L (mm)	
YT-21200	160	6/48

- GB** Electrician scissors
D Elektrische Schere
PL Nożyczki dla elektryków
RUS Ножницы универсальные
CZ Elektrické nůžky
H Univerzális olló
RO Foarfece - electrician
F Ciseaux pour electriciens
I Forbici per elettricisti
E Tijeras eléctricos
CN 电工剪



YATO	L (mm)	
YT-1974	140	12/120

- GB** Scissors
D Haushaltsschere
PL Nożyczki
RUS Ножницы
CZ Nůžky
H Olló



YATO	L (mm)	
YT-19763	170	12/120
YT-19764	190	12/120
YT-19765	215	12/120
YT-19766	245	12/120
YT-19767	300	12/120

- GB** Glass oil cutter
D Glasschneider
PL Nóż olejowy do szkła
RUS Стеклопоз масляный
CZ Řezák na sklo

- H** Olajkés üveghez
RO Diamant pt. taiat stricta cu ulei
F Couteau à l'huile pour verre
I Taglia vetro con serbatoio olio

- E** Cuchillo de aceite para cristallinación
CN 玻璃割刀



YATO	L (mm)	
YT-7560	177	6/120

YATO	L (mm)	
YT-7561	178	6/120

- GB** Double edge trimmer
D Kantentrimmer
PL Dwustronny nóż do odcinania oklein
RUS Двусторонний нож для мебельной пленки
CZ Orezávací nůž na hrany lamina
H Kétélű vágó
RO Rindea pt. finisaje
F Couteau reversible pour bois de placage
I Doppio coltello
E Cuchillo de doble filo para cortar chapas de madera
CN 双边刨子



YATO		
YT-5710		6/48

- GB** Carving knife set
D Klingensatz
PL Zestaw nożyków
RUS Набор резцов
CZ Sada nožíků
H Késkészlet
RO Set de cuțite estav
F Sculpture ensemble de couteau
I Set di coltelli
E uego de cuchillas
CN 美工刀



PLASTIC BOX & SLIDING CARD

YATO		
YT-75140		6/48

- GB** Scriber for glass, ceramics and metal
D Reißnadel für Glas, Keramik und Metall
PL Rysik do szkła, ceramiki i metalu
RUS Штихель для стекла, керамика и металла

- CZ** Rýsovací jehla na sklo, keramiku a kov
H Karctű üveghez, kerámiához és fémhez
RO Ac de trasat pt. sticlă, ceramică și metal
F Stylet verre, céramique et métal

- I** Penna di vetro ceramica metallo
E Trazador para vidrio, cerámica y metal
CN 划线器



YATO	L (mm)	
YT-3740	140	6/240

- GB** Automatic center punch
D Automatischer Körner Einstellbare
PL Punktak automatyczny
RUS Автоматический кернер
CZ Automatické důlčikem
H Automatikus központ punci

- RO** Automat centru de pumn
F Pointeau automatique
I Bulino automatico
E Centro automático punch
CN 自动中心冲



YATO	L (mm)	
YT-47160	125	12/72

- GB** Adjustable automatic center punch
D Einstellbare automatische Körners
PL Punktak automatyczny regulowany
RUS Регулируемое автоматическое кернер
CZ Nastavitelné automatické důlčikem
H Automatikus központ punci
RO Automat centru de pumn reglabil
F Pointeau automatique réglable
I Bulino automatico regolabile
E Ajustable centro automático punch
CN 可调中心冲

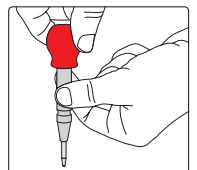

YATO	L (mm)	
YT-47161	125	12/72

GB Profile gauge
D Profilmuster
PL Wzornik profili

RUS Шаблон профилей
CZ Profilová šablona
H Profilsablón

RO Șablon profile
F Jauges d'épaisseurs métriques

I Profilato
E Plantilla de perfles
CN 轮廓仪

SLIDING CARD



44 mm

1.5 mm



YATO	L (mm)	
YT-3735	125	24/72

YATO	L (mm)	
YT-3736	260	10/40

GB Leather punch
D Lederlocher
PL Przebijak do skóry
RUS Круглый пробойник для кожи
CZ Průbojník na kůži
H Bőryukasztó

RO Preducele
F Perçoirs à cuir
I Punterulolo per pelle
E Perforar en piel
CN 皮带冲



SLIDING CARD

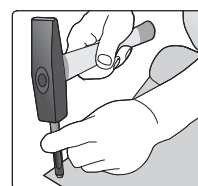

YATO	Ø (mm)	
YT-35850	2	20/100
YT-35851	3	20/100
YT-35852	4	20/100
YT-35853	5	20/100
YT-35854	6	20/100
YT-35855	7	20/100
YT-35856	8	20/100
YT-35857	9	20/100
YT-35858	10	20/100
YT-35859	11	20/100
YT-35860	12	20/100
YT-35861	13	20/100

YATO	Ø (mm)	
YT-35862	14	20/100
YT-35863	15	20/100
YT-35864	16	20/100
YT-35865	17	20/100
YT-35866	18	20/100
YT-35867	19	20/80
YT-35868	20	20/80
YT-35869	21	20/60
YT-35870	22	20/80
YT-35871	23	10/50
YT-35872	24	20/60
YT-35873	25	20/60

GB Punch set
D Lederlocherset
PL Przebijaki do skóry
RUS Набор пробойников для кожи
CZ Sada průbojníků na kůži
H Bőryukasztó készlet
RO Set preducele

F Kit de perçoirs à cuir
I Set di punzoni
E Juego de perforar en piel
CN 冲孔器组套

SLIDING CARD

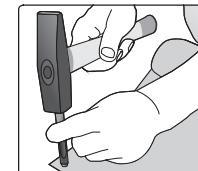

3 PCS

4 PCS

YATO	Ø (mm)	
YT-35881	6; 8; 10	20/120

YATO	Ø (mm)	
YT-35880	2; 3; 4; 5	20/120

GB Punch set
D Lederlocherset
PL Przebijaki do skóry
RUS Набор пробойников для кожи
CZ Sada průbojníků na kůži
H Bőryukasztó készlet
RO Set preducele
F Kit de perçoirs à cuir
I Set di punzoni
E Juego de perforar en piel
CN 冲孔器组套



POUCH & COLOR BOX



9 PCS

15 PCS

YATO	Ø (mm)	
YT-3590	2.5; 3.0; 4.0; 5.0; 6.0; 7.0; 8.0; 9.0; 10.0	50

YATO	Ø (mm)	
YT-3591	2.0; 2.5; 3.2; 4.0; 4.8; 5.5; 6.4; 8.0; 9.5; 11.1; 12.7; 14.0; 15.8; 19.0; 22.0	10

- GB** PVC pipe cutter
D PVC Rohrabsschneider
PL Obcinak do rur PCV
RUS Труборез для ПВХ труб
CZ Řezač PVC trubek
H Csővágó olló PVC csövekhez
RO Clește pt. tăiat țevi din PVC
F Coupeur aux tubes
I Taglia tubi PVC
E Cortatubos PVC
CN PVC 管子割刀



∅ max (mm)
35

PEX
AL
PEX

PVC
PP
PU
PE

8Cr13
STAINLESS
STEEL
STAL
NIEKORZYWA

HRC
54

SLIDING
CARD

YATO	max. ∅ (mm)	
YT-2230	35	6/48

- GB** PVC pipe cutter
D PVC Rohrabsschneider
PL Obcinak do rur PCV
RUS Труборез для ПВХ труб
CZ Řezač PVC trubek
H Csővágó olló PVC csövekhez
RO Clește pt. tăiat țevi din PVC
F Coupeur aux tubes
I Taglia tubi PVC
E Cortatubos PVC
CN PVC 管子割刀



∅ max (mm)
42

PEX
AL
PEX

PVC
PP
PU
PE

8Cr13
STAINLESS
STEEL
STAL
NIEKORZYWA

HRC
54

RATCHET
SYSTEM
ZAPADKOWY

QUICK
RELEASE
SZYBKIE
ZWALNIANIE

SLIDING
CARD

YATO	max. ∅ (mm)	
YT-2231	42	6/48

- GB** PVC pipe cutter
D PVC Rohrabsschneider
PL Obcinak do rur PCV
RUS Труборез для ПВХ труб
CZ Řezač PVC trubek
H Csővágó olló PVC csövekhez
RO Clește pt. tăiat țevi din PVC
F Coupeur aux tubes
I Taglia tubi PVC
E Cortatubos PVC
CN PVC 管子割刀



∅ max (mm)
63

PEX
AL
PEX

PVC
PP
PU
PE

8Cr13
STAINLESS
STEEL
STAL
NIEKORZYWA

HRC
56-58

RATCHET
SYSTEM
ZAPADKOWY

QUICK
RELEASE
SZYBKIE
ZWALNIANIE

SLIDING
CARD

YATO	max. ∅ (mm)	
YT-2232	63	6/24

- GB** PVC pipe cutter
D PVC Rohrabsschneider
PL Obcinak do rur PCV
RUS Труборез для ПВХ труб
CZ Řezač PVC trubek
H Csővágó olló PVC csövekhez
RO Clește pt. tăiat țevi din PVC
F Coupeur aux tubes
I Taglia tubi PVC
E Cortatubos PVC
CN PVC 管子割刀



SLIDING
CARD

PEX
AL
PEX

PVC
PP
PU
PE

8Cr13
STAINLESS
STEEL
STAL
NIEKORZYWA

HRC
54

AI

RATCHET
SYSTEM
ZAPADKOWY

QUICK
RELEASE
SZYBKIE
ZWALNIANIE

∅ max (mm)
51

YATO	max. ∅ (mm)	
YT-2228	51	6/24



∅ max (mm)
64

YATO	max. ∅ (mm)	
YT-2229	64	6/24

- GB** Pipe cutter
D Rohrabsschneider
PL Obcinak do rur
RUS Труборез для труб
CZ Řezač trubek
H Csővágó olló csövekhez
RO Clește pt. tăiat țevi
F Coupeurs aux tubes
I Rullo di taglio per tubi
E Cortatubos
CN 管子割刀

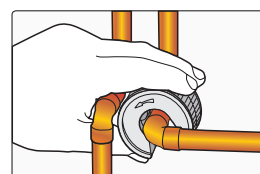

PEX

PLASTIC
Al, Cu

BEARING STEEL
STAL ŁOŻYSKOWA

SLIDING
CARD

YATO	∅	external diameter / średnica zewnętrzna (mm)	
YT-22353	19/32" (15 mm)	48	5/50
YT-22354	23/32" (18 mm)	59	10/50
YT-22355	7/8" (22 mm)	56	10/50

GB Pipe cutter CZ Řezač trubek F Coupeur aux tubes
 D Rohrschneider H Csővágó olló I Taglia tubi PVC
 PL Obcinak do rur csővekhez E Cortatubos
 RUS Труборіз для труб RO Clește pt. țăiat țevi CN 管子割刀

COLOR BOX



PEX



PLASTIC Al, Cu Ø 1/10"-7/8" BEARING STEEL STAL ŁOŻYSKOWA

YATO	Ø	
YT-22318	1/10"-7/8" (3-22 mm)	100



PLASTIC Al, Cu Ø 1/10"-5/4" QUICK-ADJUSTMENT SZYBKONASTAWNY WITH DEBURRER Z GRATOWNIKIEM BEARING STEEL STAL ŁOŻYSKOWA SPARE CUTTING WHEEL ZAPASOWE KÓŁKO TNAČE

YATO	Ø	
YT-22338	1/10"-5/4" (3-32 mm)	50



PLASTIC Al, Cu Ø 3/8"-1-5/8" BEARING STEEL STAL ŁOŻYSKOWA

YATO	Ø	
YT-2232	3/8"-1-5/8" (10-40 mm)	20



PLASTIC Al, Cu Ø 1/4"-7/4" WITH DEBURRER Z GRATOWNIKIEM BEARING STEEL STAL ŁOŻYSKOWA SPARE CUTTING WHEEL ZAPASOWE KÓŁKO TNAČE

YATO	Ø	
YT-2233	1/4"-7/4" (6-45 mm)	25



PLASTIC Al, Cu Ø 1/2"-5/2" QUICK-ADJUSTMENT SZYBKONASTAWNY BEARING STEEL STAL ŁOŻYSKOWA SPARE CUTTING WHEEL ZAPASOWE KÓŁKO TNAČE

YATO	Ø	
YT-2234	1/2"-5/2" (14-63 mm)	25



PLASTIC Al, Cu Ø 2"-5" QUICK-ADJUSTMENT SZYBKONASTAWNY BEARING STEEL STAL ŁOŻYSKOWA

YATO	Ø	
YT-2235	2"-5" (50-127 mm)	10

GB Replacement cutting wheel for pipe cutters
 D Ersatzschneidrad für Rohrschneider
 PL Zapasowe kółko tnače do obcinaka do rur
 RUS Запасной режущий диск для труборезов
 CZ Náhradní řezné kolečko na trubky frézy

H Tartalék vágókerék cső vágó
 RO Roata de schimb pt. taiere țevi
 F Molette pour coupe
 I Taglio ruote tubo taglierina
 E Rueda de corte de repuesto para cortatubos
 CN 管子割刀刀片

2 PCS
 BEARING STEEL STAL ŁOŻYSKOWA



DOUBLE BLISTER

YATO	a (mm)	b (mm)	c (mm)	for/dla:	
YT-22313	18	6	4.8	YT-2233	50/300
YT-22314	26	14	7.5	YT-2232	6/108
YT-22315	18	6	4.8	YT-22338	50/300
YT-22316	27	6.3	5	YT-2234	24/288

GB Replacement cutting wheel for pipe cutters
 D Ersatzschneidrad für Rohrschneider
 PL Zapasowe kółko tnače do obcinaka do rur
 RUS Запасной режущий диск для труборезов
 CZ Náhradní řezné kolečko na trubky frézy

H Tartalék vágókerék cső vágó
 RO Roata de schimb pt. taiere țevi
 F Molette pour coupe
 I Taglio ruote tubo taglierina
 E Rueda de corte de repuesto para cortatubos
 CN 管子割刀刀片

BEARING STEEL STAL ŁOŻYSKOWA

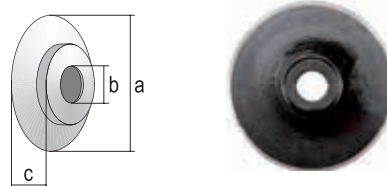

DOUBLE BLISTER

YATO	a (mm)	b (mm)	c (mm)	for/dla:	
YT-22317	44	10.6	8	YT-2235	12/144

- GB** Window scraper **CZ** Škrabák na skla **I** Coltellino con lama trapezoidale **CN** 玻璃刮刀
D Fensterabstreicher **H** Kaparó üveghez **RO** Răzuitor pt. geamuri **E** Rascador de cristales
PL Skrobak do szyb **F** Gratte-givre

HALF DOUBLE BLISTER



18x100 mm



SK5

ABS



YATO	L (mm)	
YT-7550	300	10/60



TELESCOPIC HANDLE 390-600 mm

YATO	L (mm)	
YT-7551	390-600	10/60

- GB** Scraper **H** Simitógyalu
D Ziehklinge **RO** Honuitor
PL Cyklina **F** Racléuse métal
RUS Цикля **I** Raschietto
CZ Skrabka na parkety **E** Raspador
CN 刮刀

HALF DOUBLE BLISTER



TUNGSTEN CARBIDE WEGGLIK WOLFRAM



BLADE 22 mm

YATO	L (mm)	
YT-5702	240	6/48



BLADE 50 mm

YATO	L (mm)	
YT-5703	250	6/48



BLADE 65 mm

YATO	L (mm)	
YT-5704	290	6/48

- GB** Steel file **CZ** Zámeňický pilník **I** Lime per metallo
D Werkstatt-Feile **H** Lakatos reszelő **E** Lima para metal
PL Pilnik do metalu **RO** Pila de lăcătușerie **CN** 锉
RUS Напильник слесарный **F** Lime à métal

- #1 #2 #3 T12 STEEL 150 mm 200 mm 250 mm 300 mm



YATO	#	L (mm)	
YT-62228	1	150	20/80
YT-62229	1	200	20/80
YT-6223	1	250	20/80
YT-62231	1	300	10/40
YT-6180	2	150	20/80
YT-6185	2	200	20/80
YT-6228	2	250	20/80
YT-6190	2	300	10/40
YT-62328	3	150	20/80
YT-62329	3	200	20/80
YT-6233	3	250	20/80
YT-62331	3	300	10/40



YATO	#	L (mm)	
YT-62238	1	150	20/80
YT-62239	1	200	20/80
YT-6224	1	250	20/80
YT-62241	1	300	10/40
YT-6181	2	150	20/80
YT-6186	2	200	20/80
YT-6229	2	250	20/80
YT-6191	2	300	10/40
YT-62243	3	150	20/80
YT-62244	3	200	20/80
YT-62245	3	250	20/80
YT-62246	3	300	10/40

YATO	#	L (mm)	
YT-62248	1	150	20/80
YT-62249	1	200	20/80
YT-6225	1	250	20/80
YT-62251	1	300	10/40
YT-6182	2	150	20/80
YT-6187	2	200	20/80
YT-6230	2	250	20/80
YT-6192	2	300	10/40
YT-62338	3	150	20/80
YT-62339	3	200	20/80
YT-6234	3	250	20/80
YT-62341	3	300	10/40



YATO	#	L (mm)	
YT-62258	1	150	20/80
YT-62259	1	200	20/80
YT-6226	1	250	20/80
YT-62261	1	300	10/40
YT-6183	2	150	20/80
YT-6188	2	200	20/80
YT-6231	2	250	20/80
YT-6193	2	300	10/40
YT-62348	3	150	20/80
YT-62349	3	200	20/80
YT-6235	3	250	20/80
YT-62351	3	300	10/40

YATO	#	L (mm)	
YT-62268	1	150	20/80
YT-62269	1	200	20/80
YT-6227	1	250	20/80
YT-62271	1	300	10/40
YT-6184	2	150	20/80
YT-6189	2	200	20/80
YT-6232	2	250	20/80
YT-6194	2	300	10/40
YT-62358	3	150	20/80
YT-62359	3	200	20/80
YT-6236	3	250	20/80
YT-62361	3	300	10/40

GB Steel file set
D Werkstatt-Feilen
PL Piłniki do metalu
RUS Набор напильников слесарных
CZ Zámeňické pilníky
H Lakatos reszelő
RO Pile de lăcătuşerie
F Set de limes à métal
I Lime per metallo
E Juego de limas para metal
CN 钢锉组套



SLIDING CARD



#1 **#2** **#3** **250 mm** **T12 STEEL**

3 PCS **#2** **#2** **#2**

YATO **YT-6237** 10/20



5 PCS **#1 #2** **#1** **#1** **#1**

YATO **YT-6238** 5/10



5 PCS **#3** **#3** **#3** **#3** **#3**

YATO **YT-6239** 5/10

10

GB Needle file set
D Nadelfeilsatz
PL Zestaw pilników iglaków
RUS Набор напильников надфили
CZ Sada jehlových pilníků
H Tűreszelő készlet
RO Set pile conice
F Set de limes
I Set di lime e lime ad ago

E Juego de limas de aguja
CN 什锦锉组套

POUCH



GCR15 BEARING STEEL



6 PCS **EQUALLING** **SQUARE** **THREE-SQUARE** **FLAT WARDING** **ROUND** **HALF-ROUND**
PLASKI **CZWOROKATNY** **TROJKATNY** **PLASKI ZBIENNY** **OKRAGLY** **POLOKRAGLY**

6 PCS **EQUALLING** **SQUARE** **THREE-SQUARE** **CROSSING** **ROUND** **HALF-ROUND**
PLASKI **CZWOROKATNY** **TROJKATNY** **SOCZENIOWY** **OKRAGLY** **POLOKRAGLY**

YATO working length / długość robocza (mm) mm **50/200**
YT-6160 65 3x140

YATO working length / długość robocza (mm) mm **25/100**
YT-6161 75 4x160
YT-6162 85 5x180 **25/100**

GB Needle file set
D Nadelfeilsatz
PL Zestaw pilników iglaków

RUS Набор напильников надфили
CZ Sada jehlových pilníků
H Tűreszelő készlet

RO Set pile conice
F Set de limes
I Set di lime e lime ad ago

E Juego de limas de aguja
CN 什锦锉组套

POUCH



GCR15
BEARING
STEEL

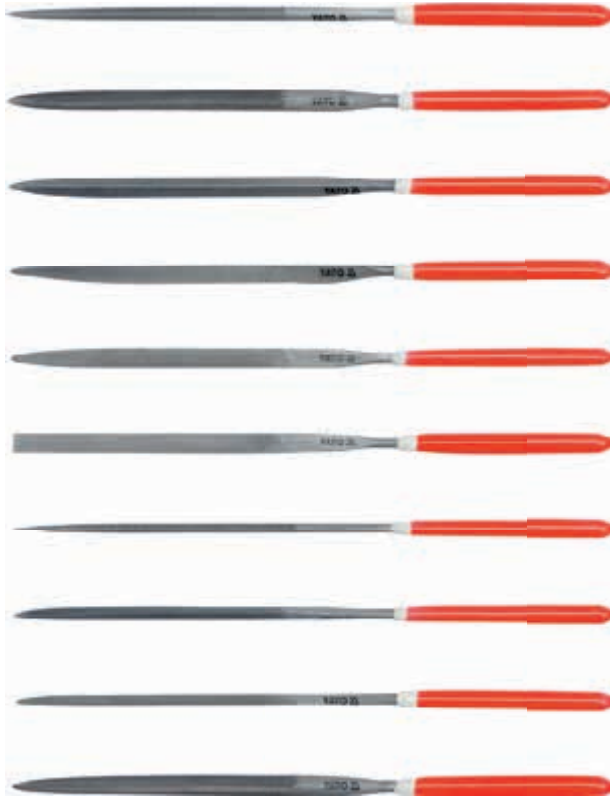

10
PCS

10
PCS

10

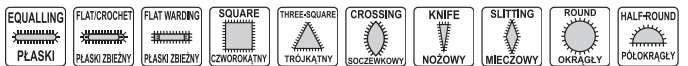

YATO	working length / długość robocza (mm)	mm	
YT-6163	65	3x140	25/100

YATO	working length / długość robocza (mm)	mm	
YT-6164	75	4x160	25/100
YT-6165	85	5x180	25/50

GB Diamond needle file
D Diamant-Nadelfeile
PL Pilnik iglak diamentowy
RUS Надфиль алмазный

CZ Diamantový jehlový pilník
H Gyémánt tűreszelő
RO Pila diamantata
F Lime diamant

I Lime ad ago diamantate
E Lima de aguja adiamantada
CN 金刚石平头扁锉

SLIDING
CARD

GRIT
ZIARNISTOŚĆ
150



YATO	grit / ziarnistość	coating length / długość nasypu (mm)	mm	
YT-6140	150	50	3x140	120/1200
YT-6147	150	50	4x160	80/800
YT-6152	150	70	5x180	45/450

YATO	grit / ziarnistość	coating length / długość nasypu (mm)	mm	
YT-6141	150	50	3x140	120/1200
YT-6148	150	50	4x160	80/800
YT-6153	150	70	5x180	45/450

YATO	grit / ziarnistość	coating length / długość nasypu (mm)	mm	
YT-6142	150	50	3x140	120/1200
YT-6149	150	50	4x160	80/800
YT-6154	150	70	5x180	45/450

GB Diamond needle file set
D Diamant-Nadelfeilsatz
PL Zestaw pilników diamentowych iglaków
RUS Набор надфилей алмазных
CZ Sada diamentových jehlových pilníků
H Gyémánt tűreszelő készlet

RO Set pile diamantate
F Set de limes diamant
I Set lime ad ago diamantate
E Juego de limas de aguja adiamantadas
CN 金刚石整形锉组套

POUCH



GRIT
ZIARNISTOŚĆ
150

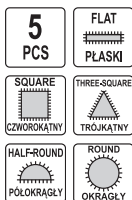
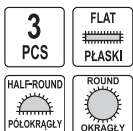

YATO	grit / ziarnistość	coating length / długość nasypu (mm)	mm	
YT-6143	150	50	3x140	40/400
YT-6150	150	50	4x160	30/300
YT-6155	150	70	5x180	15/150

YATO	grit / ziarnistość	coating length / długość nasypu (mm)	mm	
YT-6156	150	70	5x180	10/100

- GB** Diamond needle file set
- D** Diamant-Nadelfeilsatz
- PL** Zestaw pilników diamentowych iglaków
- RUS** Набор надфилей алмазных
- CZ** Sada diamentových jehlových pilníků
- H** Gyémánt tűszelő készlet
- RO** Set pile diamantate
- F** Set de limes diamant
- I** Set lime ad ago diamantate
- E** Juego de limas de aguja adiamantadas
- CN** 金刚石整形锉组套



10
PCS

GRIT
ZIARNISTOŚĆ
150

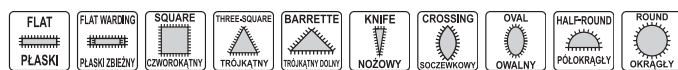

YATO	grit / ziarnistość	coating length / długość nasypu (mm)	mm	
YT-6144	150	50	3x140	12/120

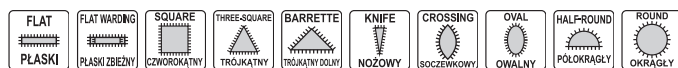

YATO	grit / ziarnistość	coating length / długość nasypu (mm)	mm	
YT-6146	150	30	3x140	12/120



YATO	grit / ziarnistość	coating length / długość nasypu (mm)	mm	
YT-6145	150	25	3x140	12/120

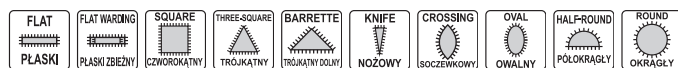

YATO	grit / ziarnistość	coating length / długość nasypu (mm)	mm	
YT-6151	150	50	4x160	9/90

- GB Wood rasp
D Holzraspelsatz
PL Tarnik do drewna
RUS Рашпиля для дерева
- CZ Rašple do dřeva
H Fareszelő
RO Raspe
F Lime à bois
- I Lime per legno
E Escarpelo para madera
CN 木工铤

PLASTIC HANGER



250 mm



# 45	YATO	#	
	YT-6219	45	12/72



# 45	YATO	#	
	YT-6220	45	12/72



# 45	YATO	#	
	YT-6221	45	12/72

- GB Wood rasp set
D Holzraspelsatz
PL Tarniki do drewna
RUS Рашпили для дерева
CZ Sada rašplí do dřeva
H Fareszelő
RO Set raspe
F Set de limes à bois
I Lime per legno
E Juego de escarpelos para madera
CN 木工铤组套



SLIDING CARD



3 PCS	# 45
250 mm	# 45
	# 45

YATO	#	
YT-6222	45	5/20

- GB Rasp for plaster
D Gipskartonplatten Rasp
PL Tarnik do gipsu
RUS Рашпиль для гипсокартона
CZ Rašple pro omítky
H Reszelt vakolat
RO Rasp pt. tencuiala
F Râpe pour plâtre
I Raspa
E Eliminador de yeso
CN 铤刨



SLIDING CARD



140x40 mm	WOOD DREWNÓ	ALUMINIUM	LAMINATES LAMINATY
-----------	-------------	-----------	--------------------

YATO	size / rozmiar (mm)	
YT-61678	140x40	15/60

- GB Blade for rasp
D Sägeblatraspel
PL Ostrze zapasowe do tarnika
RUS Лезвие для рашпиля по гипсокартону
CZ Čepel do škrabacích
H Penge reszelő
RO Lama pt. rasp
F Lame râpe
I Lama di ricambio per raspa
E Hoja para raspar
CN 铤刨刀片

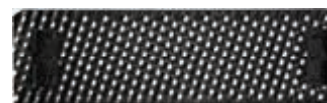

SLIDING CARD



140x40 mm	WOOD DREWNÓ	ALUMINIUM	LAMINATES LAMINATY
-----------	-------------	-----------	--------------------

YATO	size / rozmiar (mm)	
YT-61679	140x40	10/120

- GB Rasp for plaster
D Gipskartonplatten Rasp
PL Tarnik do gipsu
RUS Рашпиль для гипсокартона
CZ Rašple pro omítky
- H Reszelt vakolat
RO Rasp pt. tencuiala
F Râpe pour plâtre
I Raspa per gesso
E Eliminador de yeso
CN 铤刨

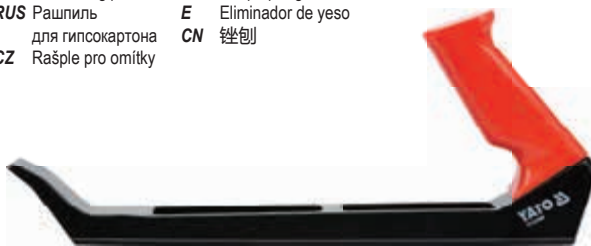

250x40 mm

WOOD DREWNÓ	ALUMINIUM	LAMINATES LAMINATY
-------------	-----------	--------------------



YATO	size / rozmiar (mm)	
YT-61680	250x40	15/60

- GB Blade for rasp
D Sägeblatraspel
PL Ostrze zapasowe do tarnika
RUS Лезвие для рашпиля по гипсокартону
CZ Čepel do škrabacích
H Penge reszelő
- RO Lama pt. rasp
F Lame râpe
I Lama di ricambio per raspa
E Hoja para raspar
CN 铤刨刀片



TIED ON CARD



250x40 mm	WOOD DREWNÓ	ALUMINIUM	LAMINATES LAMINATY
-----------	-------------	-----------	--------------------

YATO	size / rozmiar (mm)	
YT-61681	250x40	30/120

- GB Rasp for plaster
D Gipskartonplatten Rasp
PL Tarnik do gipsu
RUS Рашпиль для гипсокартона
CZ Rašple pro omítky
- H Reszelt vakolat
RO Rasp pt. tencuiala
F Râpe pour plâtre
I Raspa per gesso
E Eliminador de yeso
CN 铤刨



SLIDING CARD



260 mm	16 mm	WOOD DREWNÓ	ALUMINIUM	LAMINATES LAMINATY
--------	-------	-------------	-----------	--------------------

YATO	L (mm)	
YT-61690	260	15/60

- GB Blade for rasp
D Sägeblatraspel
PL Ostrze zapasowe do tarnika
RUS Лезвие для рашпиля по гипсокартону
CZ Čepel do škrabacích
H Penge reszelő
- RO Lama pt. rasp
F Lame râpe
I Lama di ricambio per raspa
E Hoja para raspar
CN 铤刨刀片



SLIDING CARD



YATO	L (mm)	
YT-61691	260	10/120

GB Sand paper PL Papier ścierny CZ Smirkový papír RO Hârtie abrazivă I Carta vetrata CN 砂纸
 D Schleifpapier RUS Наждачная бумага H Csiszolópapír F Papier abrasif E Papel de lija



POLYBAG



- application: paint, lacquer, filler, wood
- abrasive: aluminium oxide
- bond: synthetic resin
- backing: C
- coating: semi-open
- zastosowanie: farby, lakiery, szpachle, drewno
- ścierniwo: tlenek glinu
- spoiwo: żywica syntetyczna
- podkład: C
- nasyp półotwarty



- application: paint, lacquer, filler, wood
- abrasive: aluminium oxide
- bond: synthetic resin
- backing: D
- coating: semi-open
- zastosowanie: farby, lakiery, szpachle, drewno
- ścierniwo: tlenek glinu
- spoiwo: żywica syntetyczna
- podkład: D
- nasyp półotwarty

YATO	grit / ziarnistość	size / rozmiar (mm)	PCS packing	
YT-8350	40	230x280	50	500
YT-8351	60	230x280	50	500
YT-8352	80	230x280	50	500
YT-8353	100	230x280	50	500
YT-8354	120	230x280	50	500
YT-8355	150	230x280	50	500
YT-8356	180	230x280	50	500
YT-8357	220	230x280	50	500
YT-8358	240	230x280	50	500

YATO	grit / ziarnistość	size / rozmiar	
YT-8449	40	93 mm x 5 m	12/48
YT-8450	60	93 mm x 5 m	12/48
YT-8451	80	93 mm x 5 m	12/48
YT-8452	100	93 mm x 5 m	12/48
YT-8453	120	93 mm x 5 m	12/48
YT-8454	150	93 mm x 5 m	12/48
YT-8455	180	93 mm x 5 m	12/48
YT-8456	240	93 mm x 5 m	12/48
YT-8457	320	93 mm x 5 m	12/48



POLYBAG WITH HEADER



- application: paint, lacquer, filler, wood
- abrasive: aluminium oxide
- bond: synthetic resin
- backing: D
- coating: semi-open
- zastosowanie: farby, lakiery, szpachle, drewno
- ścierniwo: tlenek glinu
- spoiwo: żywica syntetyczna
- podkład: D
- nasyp półotwarty



- application: paint, lacquer, filler, wood
- abrasive: aluminium oxide
- bond: synthetic resin
- backing: D
- coating: semi-open
- zastosowanie: farby, lakiery, szpachle, drewno
- ścierniwo: tlenek glinu
- spoiwo: żywica syntetyczna
- podkład: D
- nasyp półotwarty

YATO	grit / ziarnistość	size / rozmiar (mm)	PCS packing	
YT-8370	40	115x280	5	24/240
YT-8371	60	115x280	5	24/240
YT-8372	80	115x280	5	24/240
YT-8373	100	115x280	5	24/240
YT-8374	120	115x280	5	24/240
YT-8375	150	115x280	5	24/240
YT-8376	180	115x280	5	24/240
YT-8377	240	115x280	5	24/240
YT-8378	320	115x280	5	24/240

YATO	grit / ziarnistość	size / rozmiar	
YT-8440	40	115 mm x 5 m	12/48
YT-8441	60	115 mm x 5 m	12/48
YT-8442	80	115 mm x 5 m	12/48
YT-8443	100	115 mm x 5 m	12/48
YT-8444	120	115 mm x 5 m	12/48
YT-8445	150	115 mm x 5 m	12/48
YT-8446	180	115 mm x 5 m	12/48
YT-8447	240	115 mm x 5 m	12/48
YT-8448	320	115 mm x 5 m	12/48



POLYBAG



- application: paint, lacquer, filler, wood
- abrasive: aluminium oxide
- bond: synthetic resin
- backing: D
- coating: semi-open
- zastosowanie: farby, lakiery, szpachle, drewno
- ścierniwo: tlenek glinu
- spoiwo: żywica syntetyczna
- podkład: D
- nasyp półotwarty



- application: paint, lacquer, filler, wood
- abrasive: aluminium oxide
- bond: synthetic resin
- backing: D
- coating: semi-open
- zastosowanie: farby, lakiery, szpachle, drewno
- ścierniwo: tlenek glinu
- spoiwo: żywica syntetyczna
- podkład: D
- nasyp półotwarty

YATO	grit / ziarnistość	size / rozmiar (mm)	PCS packing	
YT-8360	40	230x280	50	500
YT-8361	60	230x280	50	500
YT-8362	80	230x280	50	500
YT-8363	100	230x280	50	500
YT-8364	120	230x280	50	500
YT-8365	150	230x280	50	500
YT-8366	180	230x280	50	500
YT-8367	240	230x280	50	500
YT-8368	320	230x280	50	500

YATO	grit / ziarnistość	size / rozmiar	
YT-8458	40	115 mm x 50 m	2
YT-8459	60	115 mm x 50 m	2
YT-8460	80	115 mm x 50 m	2
YT-8461	100	115 mm x 50 m	2
YT-8462	120	115 mm x 50 m	2
YT-8463	150	115 mm x 50 m	2
YT-8464	180	115 mm x 50 m	2
YT-8465	240	115 mm x 50 m	2
YT-8466	320	115 mm x 50 m	2

GB Sand paper **PL** Papier ścierny **CZ** Smirkový papír **RO** Hârtie abrazivă **I** Carta vetrata **CN** 砂纸
D Schleifpapier **RUS** Наждачная бумага **H** Csiszolópapír **F** Papier abrasif **E** Papel de lija







- application: paint, lacquer, filler, wood
- abrasive: aluminium oxide
- bond: synthetic resin
- backing: F
- coating: closed

- zastosowanie: farby, lakiery, szpachle, drewno
- ścierniwo: tlenek glinu
- spoiwo: żywica syntetyczna
- podkład: F
- nasyp pełny

- application: paint, lacquer, filler, wood
- abrasive: aluminium oxide
- bond: synthetic resin
- backing: F
- coating: closed

- zastosowanie: farby, lakiery, szpachle, drewno
- ścierniwo: tlenek glinu
- spoiwo: żywica syntetyczna
- podkład: F
- nasyp pełny

YATO 	grit / ziarnistość	size / rozmiar	
YT-8481	100	150 mm x 50 m	2
YT-8482	120	150 mm x 50 m	2

YATO 	grit / ziarnistość	size / rozmiar	
YT-8483	40	200 mm x 50 m	2
YT-8484	60	200 mm x 50 m	2
YT-8485	80	200 mm x 50 m	2
YT-8486	120	200 mm x 50 m	2

GB Sand paper **PL** Papier ścierny **CZ** Smirkový papír **RO** Hârtie abrazivă **I** Carta vetrata **CN** 砂纸
D Schleifpapier **RUS** Наждачная бумага **H** Csiszolópapír **F** Papier abrasif **E** Papel de lija



WATERPROOF
WODOODPORNY

POLYBAG

WATERPROOF
WODOODPORNY



POLYBAG



- application: paint, lacquer, filler
- abrasive: silicon carbide
- bond: synthetic resin
- backing: C
- coating: closed

- zastosowanie: farby, lakiery, szpachle
- ścierniwo: węgiel krzemu
- spoiwo: żywica syntetyczna
- podkład: C
- nasyp pełny

- application: paint, lacquer, filler
- abrasive: silicon carbide
- bond: synthetic resin
- backing: A
- coating: closed

- zastosowanie: farby, lakiery, szpachle
- ścierniwo: węgiel krzemu
- spoiwo: żywica syntetyczna
- podkład: A
- nasyp pełny

YATO 	grit / ziarnistość	size / rozmiar (mm)	PCS packing:	
YT-8400	60	230x280	50	500
YT-8401	80	230x280	50	500
YT-8402	100	230x280	50	500
YT-8403	120	230x280	50	500
YT-8404	150	230x280	50	500

YATO 	grit / ziarnistość	size / rozmiar (mm)	PCS packing:	
YT-8405	180	230x280	50	500
YT-8406	220	230x280	50	500
YT-8407	240	230x280	50	500
YT-8408	280	230x280	50	500
YT-8409	320	230x280	50	500
YT-8410	360	230x280	50	500
YT-8411	400	230x280	50	500
YT-8412	500	230x280	50	500
YT-8413	600	230x280	50	500
YT-8414	800	230x280	50	500
YT-8415	1000	230x280	50	500
YT-8416	1200	230x280	50	500
YT-8417	1500	230x280	50	500
YT-8418	2000	230x280	50	500

GB Abrasive cloth sheet **RUS** Шлифовальное полотно **RO** Coli panza abraziva **E** Hojas de pano abrasivo
D Schleifgewebe blatt **CZ** Brusné plátno **F** Tissu abrasif **CN** 砂布
PL Plótno ściernie arkusz **H** Csiszolóvászon lap **I** Carta vetrata





- application: metal, wood
- abrasive: aluminium oxide
- bond: semi-resin
- backing: J
- coating: close

- zastosowanie: metal, drewno
- ścierniwo: tlenek glinu
- spoiwo: żywica
- podkład: J
- nasyp pełny

POLYBAG



YATO 	grit / ziarnistość	size / rozmiar (mm)	PCS packing:	
YT-83160	36	230x280	50	250
YT-83161	40	230x280	50	250
YT-83162	60	230x280	50	250
YT-83163	80	230x280	50	250
YT-83164	100	230x280	50	250
YT-83165	120	230x280	50	500
YT-83166	150	230x280	50	500
YT-83167	180	230x280	50	500
YT-83168	220	230x280	50	500
YT-83169	240	230x280	50	500

GB Abrasive cloth roll
D Schleifgewebe rolle
PL Płótno ściernie rolka

RUS Рулон-шлифовальное полотно
CZ Brusné plátno role
H Csiszolóvászon tekercs

RO Rola panza abraziva
F Tissu abrasif rouleau
I Carta vetrata rotolo

E Rollo de pano abrasivo
CN 砂布



- application: metal, wood
- abrasive: aluminium oxide
- bond: semi-resin
- backing: J
- coating: close

- zastosowanie: metal, drewno
- ścierniwo: tlenek glinu
- spoiwo: żywica
- podkład: J
- nasyp pełny

- application: metal, wood
- abrasive: aluminium oxide
- bond: semi-resin
- backing: J
- coating: close

- zastosowanie: metal, drewno
- ścierniwo: tlenek glinu
- spoiwo: żywica
- podkład: J
- nasyp pełny

- application: metal, wood
- abrasive: aluminium oxide
- bond: semi-resin
- backing: J
- coating: close

- zastosowanie: metal, drewno
- ścierniwo: tlenek glinu
- spoiwo: żywica
- podkład: J
- nasyp pełny

YATO	grit / ziarnistość	size / rozmiar	
YT-83180	36	150 mm x 30 m	2
YT-83181	40	150 mm x 30 m	2

YATO	grit / ziarnistość	size / rozmiar	
YT-83182	50	150 mm x 50 m	2
YT-83183	60	150 mm x 50 m	2
YT-83184	80	150 mm x 50 m	2
YT-83185	100	150 mm x 50 m	2
YT-83186	120	150 mm x 50 m	2
YT-83187	150	150 mm x 50 m	2
YT-83188	180	150 mm x 50 m	2
YT-83189	220	150 mm x 50 m	2
YT-83190	240	150 mm x 50 m	2

YATO	grit / ziarnistość	size / rozmiar	
YT-83200	24	200mm x 30 m	2
YT-83201	36	200mm x 30 m	2
YT-83202	40	200mm x 30 m	2
YT-83203	50	200mm x 50 m	2
YT-83204	60	200mm x 50 m	2
YT-83205	80	200mm x 50 m	2
YT-83206	100	200mm x 50 m	2
YT-83207	120	200mm x 50 m	2
YT-83208	150	200mm x 50 m	2
YT-83209	180	200mm x 50 m	2
YT-83210	220	200mm x 50 m	2
YT-83211	240	200mm x 50 m	2

10

GB Endless sanding belt
D Schleifband
PL Taśma ścierna bezkońcowa

RUS Шлифовальные ленты
CZ Brusný pás
H Csiszoló szalag

RO Bandă de pânză
F Bande abrasive sans fin
I Nastro abrasivo senza fine

E Pano abrasivo cinturón
CN 砂帶

HANGING COLOR BOX



- application: metal, wood
- abrasive: aluminium oxide
- bond: synthetic resin
- coating: close

- zastosowanie: metal, drewno
- ścierniwo: tlenek glinu
- spoiwo: żywica syntetyczna
- nasyp pełny

- application: metal, wood
- abrasive: aluminium oxide
- bond: synthetic resin
- coating: close

- zastosowanie: metal, drewno
- ścierniwo: tlenek glinu
- spoiwo: żywica syntetyczna
- nasyp pełny

YATO	grit / ziarnistość	size / rozmiar (mm)	PCS packing:	
YT-09743	60	10x330	10	100
YT-09744	80	10x330	10	100
YT-09745	100	10x330	10	100
YT-09746	120	10x330	10	100

YATO	grit / ziarnistość	size / rozmiar (mm)	PCS packing:	
YT-09747	60	20x520	10	50
YT-09748	80	20x520	10	50
YT-09749	100	20x520	10	50
YT-09750	120	20x520	10	50

GB No end abrasive band
D Schleifband
PL Pas ścierny bezkońcowa

RUS Шлифлента бесконечная
CZ Brusný pás
H Csiszoló szalag

RO Curea abraziva
F Bande abrasive sans fin
I Nastro abrasivo senza fine

E Banda abrasiva sin fin
CN 砂帶



- application: metal, wood
- abrasive: aluminium oxide
- bond: synthetic resin
- coating: close

- zastosowanie: metal, drewno
- ścierniwo: tlenek glinu
- spoiwo: żywica syntetyczna
- nasyp pełny

- application: metal, wood
- abrasive: aluminium oxide
- bond: synthetic resin
- coating: close

- zastosowanie: metal, drewno
- ścierniwo: tlenek glinu
- spoiwo: żywica syntetyczna
- nasyp pełny

- application: metal, wood
- abrasive: aluminium oxide
- bond: synthetic resin
- coating: close

- zastosowanie: metal, drewno
- ścierniwo: tlenek glinu
- spoiwo: żywica syntetyczna
- nasyp pełny

YATO	grit / ziarnistość	size / rozmiar (mm)	PCS packing:	
YT-83220	36	75x457	5	4/12
YT-83221	40	75x457	5	20/60
YT-83222	60	75x457	5	20/60
YT-83223	80	75x457	5	20/60
YT-83224	100	75x457	5	4/12
YT-83225	120	75x457	5	20/60
YT-83226	150	75x457	5	20/60

YATO	grit / ziarnistość	size / rozmiar (mm)	PCS packing:	
YT-83227	36	75x533	5	4/12
YT-83228	40	75x533	5	20/60
YT-83229	60	75x533	5	20/60
YT-83230	80	75x533	5	20/60
YT-83231	100	75x533	5	20/60
YT-83232	120	75x533	5	4/12
YT-83233	150	75x533	5	4/12

YATO	grit / ziarnistość	size / rozmiar (mm)	PCS packing:	
YT-83234	36	100x610	5	2/6
YT-83235	40	100x610	5	2/6
YT-83236	60	100x610	5	10/30
YT-83237	80	100x610	5	4/12
YT-83238	100	100x610	5	4/12
YT-83239	120	100x610	5	4/12
YT-83240	150	100x610	5	4/12

GB Flap disc – regular shape
D Fächerschleifscheibe - Gerade
PL Ściernica listkowa talerzowa płaska
RUS Круг лепестковый тарельчатый
CZ Lamelový brusný kotouč
H Lamellás csiszoló normál

RO Disc lamelar frontal
F Disque à lamelles abrasives plat
I Disco abrasivo per metallo
E Discos de paño abrasivo
CN 百叶轮

- application: metal
- abrasive: aluminium oxide
- bond: synthetic resin
- backing: fibreglass
- zastosowanie: metal
- ścierniwo: tlenek glinu
- spoiwo: żywica syntetyczna
- podkład: włókno szklane



YATO	grit / ziarnistość	size / rozmiar (mm)	📦
YT-83271	36	125x22.4	25/100
YT-83272	40	125x22.4	25/100
YT-83273	60	125x22.4	50/200
YT-83274	80	125x22.4	50/200
YT-83275	100	125x22.4	50/200
YT-83276	120	125x22.4	50/200

GB Flap disc – depressed shape
D Fächerschleifscheibe - Gewölbt
PL Ściernica listkowa talerzowa wypukła
RUS Круг лепестковый тарельчатый
CZ Lamelový brusný kotouč - vypouklý
H Lamellás csiszoló döntött

RO Disc lamelar frontal depresat
F Disque à lamelles abrasives bombé
I Disco abrasivo a centro depresso
E Discos de paño abrasivo centro embutido
CN 百叶轮

- application: metal
- abrasive: aluminium oxide
- bond: synthetic resin
- backing: fibreglass
- zastosowanie: metal
- ścierniwo: tlenek glinu
- spoiwo: żywica syntetyczna
- podkład: włókno szklane



YATO	grit / ziarnistość	size / rozmiar (mm)	📦
YT-83291	36	125x22.4	25/100
YT-83292	40	125x22.4	25/100
YT-83293	60	125x22.4	50/200
YT-83294	80	125x22.4	50/200
YT-83295	100	125x22.4	50/200
YT-83296	120	125x22.4	50/200

GB Flap wheel with shaft
D Fächerschleifmop mit Schaft
PL Ściernica listkowa trzpieniowa
RUS Круг лепестковый со шпинделем
CZ Lamelový kotouč s hřídelý
H Legyező csiszoló csapos

RO Perie abraziva circulara cu tija
F Disque à lamelles abrasives pivot
I Ruote lamellari
E Rueda laminar en tela abrasiva
CN 百叶轮

- application: metal
- abrasive: aluminium oxide
- bond: synthetic resin
- zastosowanie: metal
- ścierniwo: tlenek glinu
- spoiwo: żywica syntetyczna



- application: metal
- abrasive: aluminium oxide
- bond: synthetic resin
- zastosowanie: metal
- ścierniwo: tlenek glinu
- spoiwo: żywica syntetyczna

YATO	grit / ziarnistość	size / rozmiar (mm)	📦
YT-83351	40	40x20x6	10/60
YT-83352	60	40x20x6	10/60
YT-83353	80	40x20x6	10/60
YT-83354	100	40x20x6	10/60
YT-83355	120	40x20x6	10/60
YT-83356	150	40x20x6	10/60

YATO	grit / ziarnistość	size / rozmiar (mm)	📦
YT-83361	40	60x30x6	10/60
YT-83362	60	60x30x6	10/60
YT-83363	80	60x30x6	10/60
YT-83364	100	60x30x6	10/60
YT-83365	120	60x30x6	10/60
YT-83366	150	60x30x6	10/60

- application: metal
- abrasive: aluminium oxide
- bond: synthetic resin
- zastosowanie: metal
- ścierniwo: tlenek glinu
- spoiwo: żywica syntetyczna



- application: metal
- abrasive: aluminium oxide
- bond: synthetic resin
- zastosowanie: metal
- ścierniwo: tlenek glinu
- spoiwo: żywica syntetyczna

YATO	grit / ziarnistość	size / rozmiar (mm)	📦
YT-83371	40	80x30x6	10/60
YT-83372	60	80x30x6	10/60
YT-83373	80	80x30x6	10/60
YT-83374	100	80x30x6	10/60
YT-83375	120	80x30x6	10/60
YT-83376	150	80x30x6	10/60

YATO	grit / ziarnistość	size / rozmiar (mm)	📦
YT-83381	40	80x40x6	10/60
YT-83382	60	80x40x6	10/60
YT-83383	80	80x40x6	10/60
YT-83384	100	80x40x6	10/60
YT-83385	120	80x40x6	10/60
YT-83386	150	80x40x6	10/60

GB Flap wheel with shaft
D Fächerschleifmop mit Schaft
PL Ściernica listkowa trzpieniowa
RUS Круг лепестковый со шпинделем
CZ Lamelový kotouč s hřídelý
H Legyező csiszoló csapos

RO Perie abraziva circulara cu tija
F Disque à lamelles abrasives pivot
I Ruote lamellari
E Rueda laminar en tela abrasiva
CN 百叶轮

- application: metal
- abrasive: aluminium oxide
- bond: synthetic resin

- zastosowanie: metal
- ścierniwo: tlenek glinu
- spoiwo: żywica syntetyczna

- application: metal
- abrasive: aluminium oxide
- bond: synthetic resin

- zastosowanie: metal
- ścierniwo: tlenek glinu
- spoiwo: żywica syntetyczna

- application: metal
- abrasive: aluminium oxide
- bond: synthetic resin

- zastosowanie: metal
- ścierniwo: tlenek glinu
- spoiwo: żywica syntetyczna

YATO	grit / ziarnistość	size / rozmiar (mm)	📦
YT-83390	60	50x30x6	10/60
YT-83391	100	50x30x6	10/60
YT-83392	150	50x30x6	10/60
YT-83393	200	50x30x6	10/60

YATO	grit / ziarnistość	size / rozmiar (mm)	📦
YT-83394	60	60x50x6	10/60
YT-83395	100	60x50x6	10/60
YT-83396	150	60x50x6	10/60
YT-83397	200	60x50x6	10/60

YATO	grit / ziarnistość	size / rozmiar (mm)	📦
YT-83398	60	80x50x6	10/60
YT-83399	100	80x50x6	10/60
YT-83400	150	80x50x6	10/60
YT-83401	200	80x50x6	10/60

GB Abrasive disc
D Schleifpapier zum Gummiteiler
PL Krażek ścierny
RUS Круг шлифовальный
CZ Brusný kotouč
H Csiszolótárcsa
RO Disc abraziv
F Disques abrasifs avec velcro
I Disco abrasivo
E Juego de discos abrasivos
CN 圆形砂纸



5
PCS
HOOK
FASTENER
RZEP

- application: metal, wood
- abrasive: aluminium oxide
- bond: synthetic resin
- backing: C
- coating: semi-open
- zastosowanie: metal, drewno
- ścierniwo: tlenek glinu
- spoiwo: żywica syntetyczna
- podkład: C
- nasyp półotwarty

YATO	grit / ziarnistość	Ø (mm)	📦
YT-83420	36	115	50/200
YT-83421	40	115	50/200
YT-83422	60	115	50/200
YT-83423	80	115	50/200
YT-83424	100	115	50/200
YT-83425	120	115	50/200
YT-83426	150	115	50/200
YT-83427	180	115	50/200
YT-83428	220	115	50/200



GB Abrasive disc
D Schleifpapier zum Gummiteiler
PL Krażek ścierny
RUS Круг шлифовальный
CZ Brusný kotouč
H Csiszolótárcsa
RO Disc abraziv
F Disques abrasifs avec velcro
I Disco abrasivo
E Juego de discos abrasivos
CN 圆形砂纸



5
PCS
HOOK
FASTENER
RZEP

- application: metal, wood
- abrasive: aluminium oxide
- bond: synthetic resin
- backing: C
- coating: semi-open
- zastosowanie: metal, drewno
- ścierniwo: tlenek glinu
- spoiwo: żywica syntetyczna
- podkład: C
- nasyp półotwarty

YATO	grit / ziarnistość	Ø (mm)	📦
YT-83430	36	125	50/200
YT-83431	40	125	50/200
YT-83432	60	125	50/200
YT-83433	80	125	50/200
YT-83434	100	125	50/200
YT-83435	120	125	50/200
YT-83436	150	125	50/200
YT-83437	180	125	50/200
YT-83438	220	125	50/200

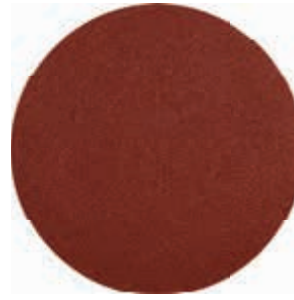

GB Abrasive disc with holes
D Schleifpapier zum Gummiteiler mit lochen
PL Krażek ścierny z otworami
RUS Круг шлифовальный перфорированный с липучкой
CZ Brusný kotouč z otvorami
H Fibertárcsa lyukkakkal tépózárás
RO Disc abraziv cu orificii
F Disques abrasifs trous avec velcro
I Disco abrasivo con fori
E Juego de discos abrasivos con agujeros
CN 圆形带孔砂纸



5
PCS
HOOK
FASTENER
RZEP

- application: metal, wood
- abrasive: aluminium oxide
- bond: synthetic resin
- backing: C
- coating: semi-open
- zastosowanie: metal, drewno
- ścierniwo: tlenek glinu
- spoiwo: żywica syntetyczna
- podkład: C
- nasyp półotwarty

YATO	grit / ziarnistość	Ø (mm)	📦
YT-83440	36	115	50/200
YT-83441	40	115	50/200
YT-83442	60	115	50/200
YT-83443	80	115	50/200
YT-83444	100	115	50/200
YT-83445	120	115	50/200
YT-83446	150	115	50/200
YT-83447	180	115	50/200
YT-83448	220	115	50/200



GB Abrasive disc with holes
D Schleifpapier zum Gummiteiler mit lochen
PL Krażek ścierny z otworami
RUS Круг шлифовальный перфорированный с липучкой
CZ Brusný kotouč z otvorami
H Fibertárcsa lyukkakkal tépózárás
RO Disc abraziv cu orificii
F Disques abrasifs trous avec velcro
I Disco abrasivo con fori
E Juego de discos abrasivos con agujeros
CN 圆形带孔砂纸



5
PCS
HOOK
FASTENER
RZEP

- application: metal, wood
- abrasive: aluminium oxide
- bond: synthetic resin
- backing: C
- coating: semi-open
- zastosowanie: metal, drewno
- ścierniwo: tlenek glinu
- spoiwo: żywica syntetyczna
- podkład: C
- nasyp półotwarty

YATO	grit / ziarnistość	Ø (mm)	📦
YT-83451	40	125	50/200
YT-83452	60	125	50/200
YT-83453	80	125	50/200
YT-83454	100	125	50/200
YT-83455	120	125	50/200
YT-83456	150	125	50/200
YT-83457	180	125	50/200
YT-83458	220	125	50/200

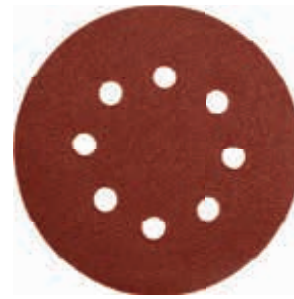

GB Abrasive sheet with holes
D Schleifgewebe-scheiben mit lochen
PL Arkusz ścierny z otworami
RUS Шлифовальная перфорированная бумага для виброшлифмашинки
CZ Brusné archy z otvorami
H Csiszoló lap lyukkakkal
RO Coale (foi) abrazive cu orificii
F Disques abrasifs trous avec velcro
I Disco abrasivo con fori
E Ojas abrasivas con agujeros
CN 方形带孔砂纸



5
PCS
HOOK
FASTENER
RZEP

- application: paint, lacquer, filler
- abrasive: aluminium oxide
- bond: synthetic resin
- backing: C
- coating: semi-open
- zastosowanie: farby, lakiery, szpachle
- ścierniwo: tlenek glinu
- spoiwo: żywica syntetyczna
- podkład: C
- nasyp półotwarty

YATO	grit / ziarnistość	size / rozmiar (mm)	📦
YT-83480	40	93x180	25/100
YT-83481	60	93x180	25/100
YT-83482	80	93x180	25/100
YT-83483	100	93x180	25/100
YT-83484	120	93x180	25/100
YT-83485	150	93x180	50/200
YT-83486	180	93x180	50/200
YT-83487	220	93x180	50/200
YT-83488	240	93x180	50/200

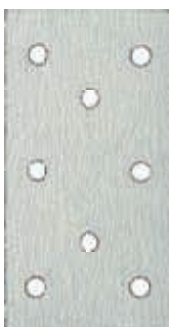

GB Abrasive sheet with holes
D Schleifgewebe-scheiben mit lochen
PL Arkusz ścierny z otworami
RUS Шлифовальная перфорированная бумага для виброшлифмашинки
CZ Brusné archy z otvorami
H Csiszoló lap lyukkakkal
RO Coale (foi) abrazive cu orificii
F Disques abrasifs trous avec velcro
I Disco abrasivo con fori
E Ojas abrasivas con agujeros
CN 方形带孔砂纸



5
PCS
HOOK
FASTENER
RZEP

- application: metal, wood
- abrasive: aluminium oxide
- bond: synthetic resin
- backing: C
- coating: semi-open
- zastosowanie: metal, drewno
- ścierniwo: tlenek glinu
- spoiwo: żywica syntetyczna
- podkład: C
- nasyp półotwarty

YATO	grit / ziarnistość	size / rozmiar (mm)	📦
YT-83490	40	93x230	25/100
YT-83491	60	93x230	25/100
YT-83492	80	93x230	25/100
YT-83493	100	93x230	25/100
YT-83494	120	93x230	25/100
YT-83495	150	93x230	25/100
YT-83496	180	93x230	25/100
YT-83497	220	93x230	25/100
YT-83498	240	93x230	25/100





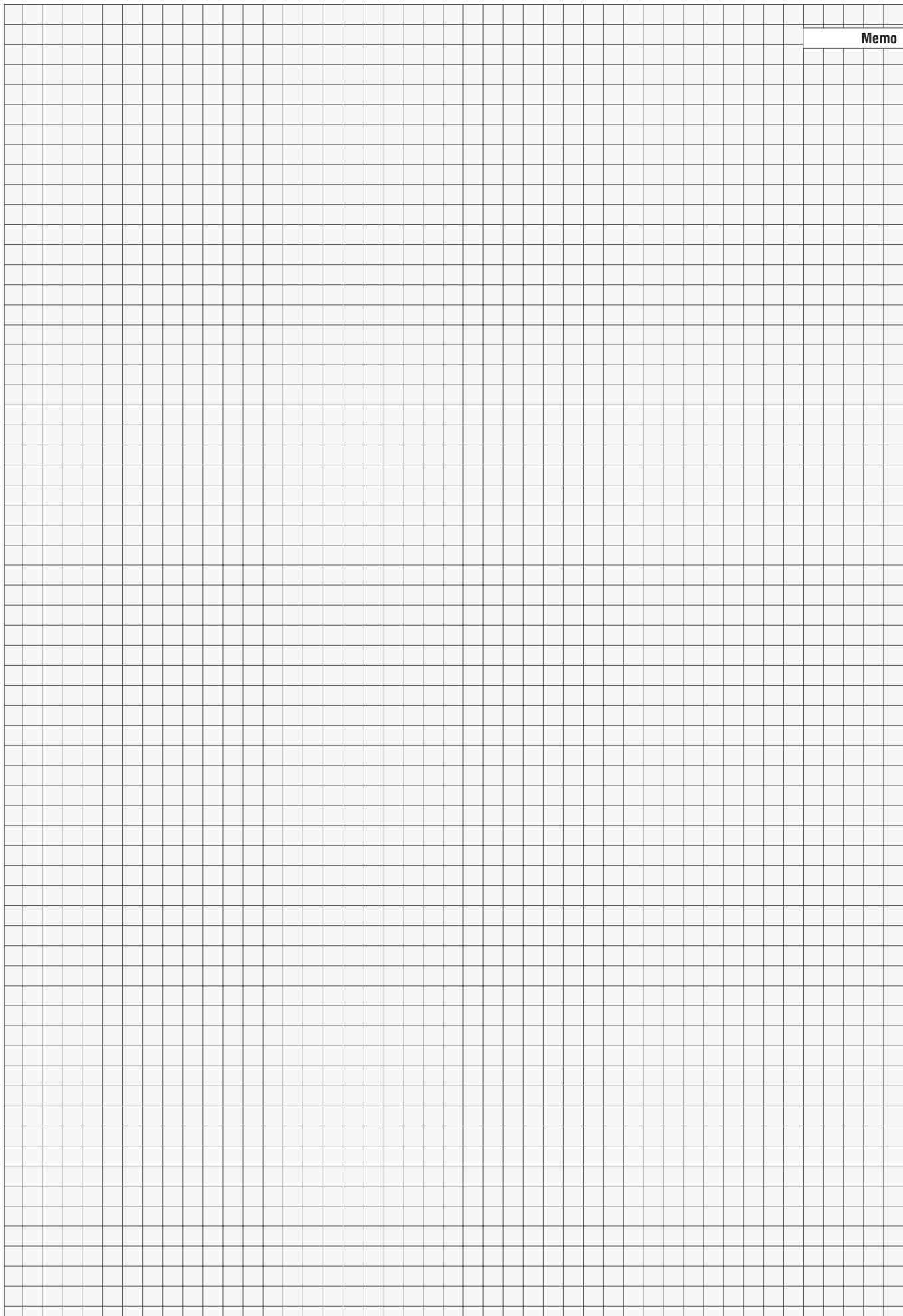





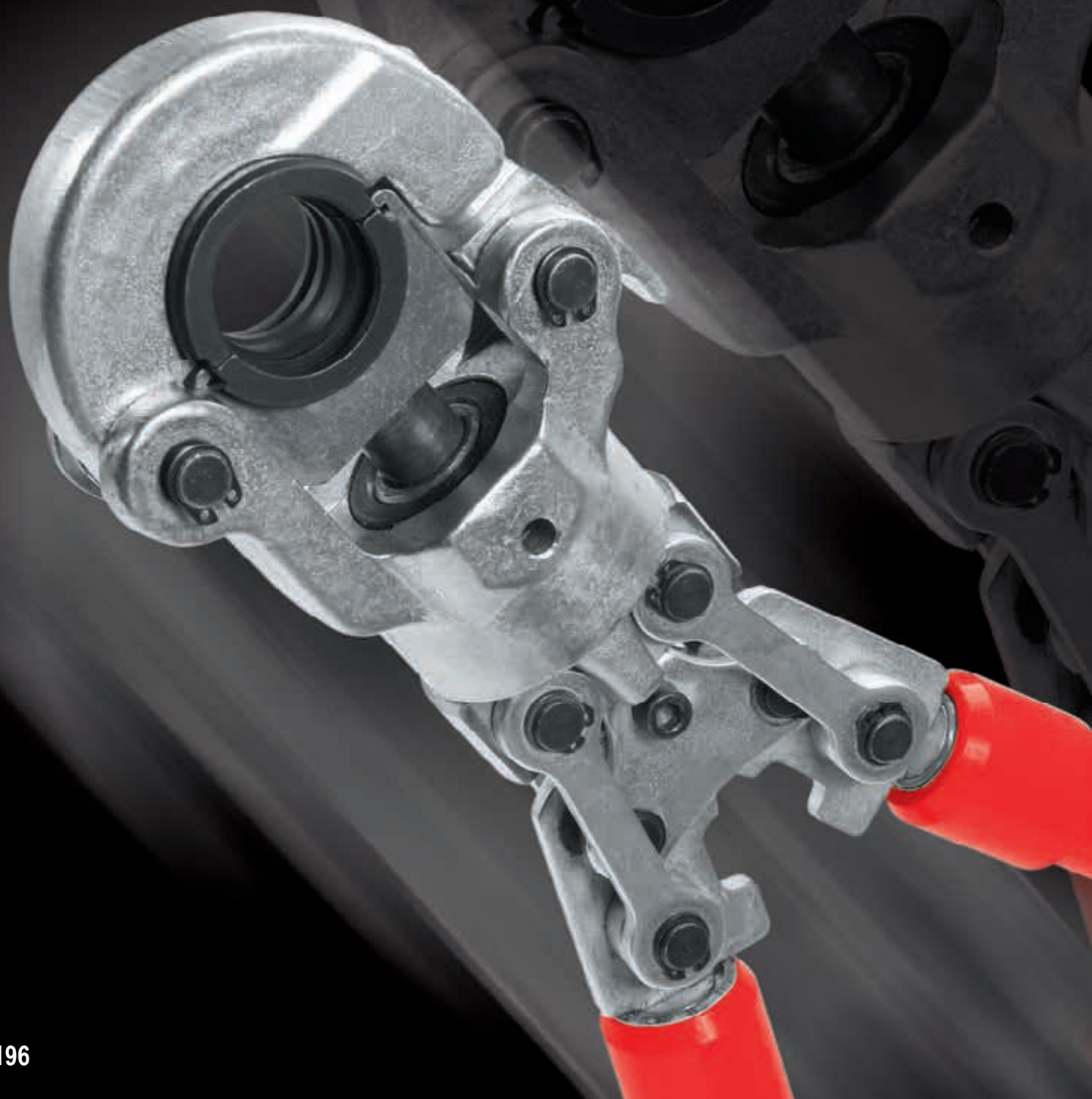











Memo



11

Hydraulic tools Narzędzia hydrauliczne



<p>Ratchet die stock sets Gwintownice ręczne z zestawem głowic</p> <p>198</p>		<p>Calibrators Kalibratory</p> <p>203</p>	
<p>Accessories for ratchet die stock Akcesoria do gwintownic ręcznych</p> <p>198</p>		<p>Burners & soldering tools Palniki i lutownice</p> <p>204</p>	
<p>Pipe wrenches Klucze do rur</p> <p>198-199</p>		<p>Pipe welders Zgrzewarki do rur</p> <p>205</p>	
<p>Strap wrenches Klucze do rur taśmowe</p> <p>199</p>		<p>Pipe crimping pliers & accessories Zaciskarki do rur i akcesoria</p> <p>205</p>	
<p>Chain pipe wrenches Klucze do rur łańcuchowe</p> <p>200</p>		<p>Hinged pipe vices Imadła zaciskowe do rur</p> <p>205</p>	
<p>Water pump pliers Szczypce nastawne</p> <p>200</p>		<p>Deburrers & accessories Gratowniki i akcesoria</p> <p>206</p>	
<p>Step wrenches Klucze sztorcowe</p> <p>200</p>		<p>Pipe brushes Szczotki do rur</p> <p>206</p>	
<p>Pipe cutters Obcinaki do rur</p> <p>201-202</p>		<p>Cleaning pads for pipes Włókniny do czyszczenia rur</p> <p>206</p>	
<p>Pipe benders Giętarki do rur</p> <p>203</p>		<p>Tool boxes & tools in PVC trays Skrzynki narzędziowe i zestawy narzędzi do szuflad</p> <p>207-208</p>	
<p>Hand flaring tools sets Praski do rozszerzania rur</p> <p>203</p>			

- GB** Ratchet die stocks
D Rohrgewinde-schneidsatz
PL Gwintownica z zestawem glowic
RUS Набор плашек
CZ Sada závitníků
H Menetfűró készlet
- RO** Trusa filiere
F Taraud manuel
I Filiera per tubi a mano
E Juego de roscar
CN 管子铰板组套

BMC
& COLOR
SLEEVE



9Cr2



5 PCS	3/8" 10mm	1/2" 12.5mm	3/4" 19mm	1" 25mm
----------	--------------	----------------	--------------	------------

7 PCS	1/4" 6.3mm	3/8" 10mm	1/2" 12.5mm	3/4" 19mm	1" 25mm	5/4" 32mm
----------	---------------	--------------	----------------	--------------	------------	--------------

YATO	size / rozmiar	
YT-29001	3/8" (10.0 mm); 1/2" (12.5 mm); 3/4" (19.0 mm); 1" (25.0 mm)	4

YATO	size / rozmiar	
YT-2900	1/4" (6.3 mm); 3/8" (10.0 mm); 1/2" (12.5 mm); 3/4" (19.0 mm); 1" (25.0 mm); 5/4" (32.0 mm)	4

- GB** Spare knives for ratchet die stock
D Rohrgewinde-Schneidbacken
PL Noże zapasowe do gwintownicy ręcznej
RUS Запасные ножи для оправки трубной резьбы
CZ Náhradní nože do ručního závitofezu
H Tartalék kések, racsnis csőmenetvágóhoz
- RO** Cutit de rezerva pt. filiera
F Lame pour taraud à main
I Lame di ricambio per filettatrici manuale
E Filos de recambio para terraja de mano
CN 板牙

4
PCS

9Cr2



POLYBAG
WITH HEADER



YATO	size / rozmiar	PCS packing	
YT-2910	1/4" (6.3 mm)	4	50/200
YT-2911	3/8" (10.0 mm)	4	50/200
YT-2912	1/2" (12.5 mm)	4	50/200
YT-2913	3/4" (19.0 mm)	4	50/200
YT-2914	1" (25.0 mm)	4	50/200

- GB** Spare head for ratchet die stock
D Rohrgewinde-Schneidköpfe
PL Glowica zapasowa do gwintownicy ręcznej
RUS Запасная оправка для нарезания трубной резьбы
CZ Náhradní hlava pro ruční závitofez
H Tartalék fej, racsnis csőmenetvágóhoz
RO Cap de rezerva pt. placa filetat cu clichet
F Mandrin porte-taraud
I Testina ricambio per filettatrici manuale
E Cabeza de recambio para terraja de mano
CN 板牙头

9Cr2



COLOR BOX

YATO	size / rozmiar	
YT-2916	1/4" (6.3 mm)	10/40
YT-2917	3/8" (10.0 mm)	10/40
YT-2918	1/2" (12.5 mm)	10/40
YT-2919	3/4" (19.0 mm)	10/40
YT-2920	1" (25.0 mm)	10/40
YT-2921	5/4" (32.0 mm)	10/40

- GB** Pipe wrench
D Rohrschlüssel
PL Klucz do rur
- RUS** Ключ трубный
CZ Klíč součásti na trubky
H Csőkulcs
- RO** Cheie reglabila pt. tevi
F Clé aux tubes
I Chiave per tubi
- E** Llave para tubos
CN 铝合金管钳

CrMo

HRC
55-60

AL
HANDLE
UCHWYT



HRC
55-60

AL
HANDLE
UCHWYT



YATO	size / rozmiar	max. pipe diameter / max. średnica rury	
YT-2482	14" (350 mm)	2" (50 mm)	6/12
YT-2483	18" (450 mm)	2.5" (63 mm)	2/10
YT-2484	24" (600 mm)	3" (75 mm)	2/6
YT-2485	36" (900 mm)	5" (125 mm)	3

YATO	size / rozmiar	max. pipe diameter / max. średnica rury	
YT-2222	12" (300 mm)	1" (25 mm)	6/24
YT-2223	14" (350 mm)	1.5" (38 mm)	4/16
YT-2224	18" (450 mm)	2" (50 mm)	3/12
YT-2225	24" (600 mm)	2.5" (63 mm)	3/6

HRC
55-60

OFFSET
TYPE
ODGIĘTA
GŁOWICA



CrMo

HRC
55-60



YATO	size / rozmiar	max. pipe diameter / max. średnica rury	
YT-2201	10" (250 mm)	1" (25 mm)	6/36
YT-2203	14" (350 mm)	1.5" (38 mm)	4/16
YT-2204	18" (450 mm)	2" (50 mm)	3/12
YT-2205	24" (600 mm)	2.5" (63 mm)	3/6
YT-2206	36" (900 mm)	4" (100 mm)	2/4

YATO	size / rozmiar	max. pipe diameter / max. średnica rury	
YT-2488	10" (250 mm)	1" (25 mm)	6/18
YT-2489	12" (300 mm)	1.5" (38 mm)	6/12
YT-2490	14" (350 mm)	2" (50 mm)	2/10
YT-2491	18" (450 mm)	2.5" (63 mm)	3/6
YT-2492	24" (600 mm)	3" (75 mm)	2/4
YT-2493	36" (900 mm)	5" (125 mm)	1
YT-2494	48" (1200 mm)	6" (150 mm)	1

GB Adjustable pipe wrench
D Rohrschlüssel
PL Klucz nastawny do rur
RUS Ключ трубный переставной

CZ Nastavitelný klíč na trubky
H Állítható csőkulcs
RO Cheie reglabilă pt. țevi
F Clé serre-tube „suédois”

I Pinze regolabili per tubi
E Llave para tubos tipo Inglesa
CN 鷹嘴鉗

COLOR BOX



90°	1"	1.5"	2"
	25mm	38mm	50mm
	DIN 5234	CrV 6140	

YATO	max. pipe diameter / max. średnica rury	L (mm)	
YT-2210	1" (25 mm)	320	24
YT-2211	1.5" (38 mm)	420	18
YT-2212	2" (50 mm)	560	12

GB Adjustable pipe wrench
D Rohrschlüssel
PL Klucz nastawny do rur
RUS Ключ трубный переставной

CZ Nastavitelný klíč na trubky
H Állítható csőkulcs
RO Cheie reglabilă pt. țevi
F Clé serre-tube „suédois”

I Pinze regolabili per tubi
E Llave para tubos tipo Inglesa
CN 鷹嘴鉗

COLOR BOX



45°	1"	1.5"	2"
	25mm	38mm	50mm
	DIN 5234	CrV 6140	

YATO	max. pipe diameter / max. średnica rury	L (mm)	
YT-2213	1" (25 mm)	330	24
YT-2214	1.5" (38 mm)	415	18
YT-2215	2" (50 mm)	530	12

GB Adjustable pipe wrench
D Rohrschlüssel
PL Klucz nastawny do rur
RUS Ключ трубный переставной

CZ Nastavitelný klíč na trubky
H Állítható csőkulcs
RO Cheie reglabilă pt. țevi
F Clé serre-tube „suédois”

I Pinze regolabili per tubi
E Llave para tubos tipo Inglesa
CN 鷹嘴鉗

COLOR BOX



S	1"	1.5"	2"
	25mm	38mm	50mm
	DIN 5234	CrV 6140	

YATO	max. pipe diameter / max. średnica rury	L (mm)	
YT-2216	1" (25 mm)	330	24
YT-2217	1.5" (38 mm)	420	18
YT-2218	2" (50 mm)	535	12

GB Auto-adjustable pipe wrench
D Rollgabelschlüssel
PL Szybkonastawny klucz do rur
RUS Ключ разводной
CZ Nastavitelný klíč
H Állítható svédkulcs

RO Cheie reglabilă
F Clé á molette
I Chiave autoregolabile per tubi
E Llave ajustable
CN 可調式管鉗

16-38 mm
5/8"-1 1/2"
300 mm

SELF-ADJUSTING SAMO-NASTAWNY
QUICK RELEASE SZYBKIE OTWIERANIE

HRC 46-52
HARDENED JAWS HARTOWANE SZCZĘKI

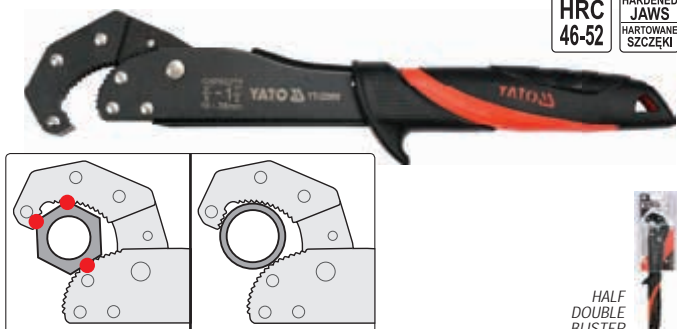

YATO	L (mm)	
YT-22005	300	6/24

GB Strap wrench
D Bandschlüssel
PL Klucz taśmowy do rur
RUS Стрчковый ключ
CZ Klíč s popruhem
H Csőfogó

RO Cheie cu chinga
F Clé a sangle sanitaire
I Chiave a nastro per tubi
E Llave de correa
CN 皮帶管鉗

300 mm
12"
200 mm
8"

STRAP SIZE WYMIAR PASKA 825 x 28 mm
NYLON AI

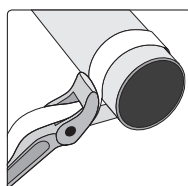

for:
• chromed pipes
• PVC pipes
• oil filters

do:
• rur chromowanych
• rur PCV
• filtrów oleju



SLIDING CARD

YATO	L (mm)	max. pipe diameter / max. średnica rury	
YT-22255	300	8" (200 mm)	5/50

GB Pipe wrench - german type
D Rohrschlüssel - deutsch type
PL Klucz do rur - typ niemiecki
RUS Трубный ключ - немецкий тип
CZ Nastavitelný klíč na trubky - němečina typ

H Állítható csőkulcs - német típusú
RO Cheie reglabilă pt. țevi - tip german
F Clé serre-tube type allemand
I Chiave per tubi - tipo tedesco
E Llave para tubos tipo alemán
CN 德式管子鉗

HRC 47-53

HARDENED JAWS HARTOWANE SZCZĘKI



COLOR BOX

YATO	L (mm)	max. opening capacity / max. zakres rozwarcia szczęk (mm)	max. pipe diameter / max. średnica rury (mm)	
YT-22000	7" (175 mm)	45	20	6/60
YT-22001	9" (225 mm)	60	30	6/36
YT-22002	10.5" (275 mm)	70	35	6/24

GB Strap for pipe wrench
D Gurt für Bandschlüssel
PL Taśma zapasowa do klucza do rur
RUS Ремень для ремешковые ключи
CZ Popruh pro klíče olejových filtrů

H Szíjas az szíjas csőfogó
RO Chinga la chei cu chingă
F Courroie pour clés a courroie
I Nastro di ricambio per chiave per tubi
E Correa a llaves de correa
CN 皮帶管鉗配件

200 mm
8"
STRAP SIZE WYMIAR PASKA 825 x 28 mm
NYLON

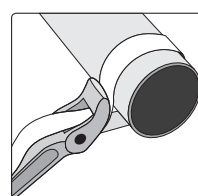

for / dla: YAT-22255



for:
• chromed pipes
• PVC pipes
• oil filters

do:
• rur chromowanych
• rur PCV
• filtrów oleju

POLYBAG WITH HEADER

YATO	
YT-22256	50

- GB Chain pipe wrench
- D Kettenrohrzange
- PL Klucz łańcuchowy do rur
- RUS Ключ цепной для труб
- CZ Klíč řetězový na trubky
- H Láncos csőfogó
- RO Cheie reglabila pt. tevi cu lant
- F Clé à chaîne
- I Chiave a catena per tubi
- E Llave de cadena
- CN 链条管子钳



SLIDING CARD



4" 300 mm
 100 mm
 INDUCTION HARDENED TEETH
 ZĘBY HARTOWANE INDUSTRYJNIE
 ADJUSTABLE WORKING RANGE
 REGULOWANY ZAKRES PRACY

YATO	L (mm)	max. pipe diameter / max. średnica rury	
YT-22260	300	4" (100 mm)	6/24

- GB Water pump pliers
- D Wasserpumpenzange
- PL Szczypce nastawne
- RUS Клещи переставные
- CZ Kelešťe siko
- H Vizpumpafagó

- RO Cleste papagal
- F Pince réglable
- I Pinze regolabili
- E Alicates de fontanero ajustables
- CN 水泵钳

250 mm 300 mm CrV
 WORKING RANGE ADJUSTMENT
 REGULACJA ZAKRESU PRACY
 STRENGTHENED JAWS
 WZMOCNIONA KONSTRUKCJA



YATO	L (mm)	
YT-2090	250	6/36
YT-2091	300	6/36

- GB Water pump pliers
- D Wasserpumpenzange
- PL Szczypce nastawne
- RUS Клещи переставные
- CZ Kelešťe siko
- H Vizpumpafagó

- RO Cleste papagal
- F Pince réglable
- I Pinze regolabili
- E Alicates de fontanero ajustables
- CN 水泵钳

250 mm 6 mm CrV
 JAW WIDTH SZEROKOSC SZCZEK
 WORKING RANGE ADJUSTMENT
 REGULACJA ZAKRESU PRACY
 STRENGTHENED JAWS
 WZMOCNIONA KONSTRUKCJA



YATO	L (mm)	
YT-20911	250	10/50

- GB Water pump pliers
- D Wasserpumpenzange
- PL Szczypce nastawne
- RUS Клещи переставные
- CZ Kelešťe siko
- H Vizpumpafagó

- RO Cleste papagal
- F Pince réglable
- I Pinze regolabili
- E Alicates de fontanero ajustables
- CN 水泵钳

HALF DOUBLE BLISTER



250 mm NICKEL IRON FINISH



YATO	L (mm)	
YT-2069	250	6/36



YATO	L (mm)	
YT-2070	250	6/24

- GB Water pump pliers
- D Wasserpumpenzange
- PL Szczypce nastawne
- RUS Клещи переставные
- CZ Kelešťe siko
- H Vizpumpafagó
- RO Cleste papagal
- F Pince réglable
- I Pinze regolabili
- E Alicates de fontanero ajustables
- CN 水泵钳



250 mm CrV 1000 V D'E

1000V VDE CERTIFICATE EN 60900:2012

HALF DOUBLE BLISTER



YATO	L (mm)	
YT-21161	250	6/24

- GB Internal ratchet wrench
- D Innenratschenschlüssel
- PL Grzechotka wewnętrzna
- RUS Трещотка внутренняя
- CZ Radiátorový kluč s ráčnou
- H Lépcsős kulcskészlet racsniával

- RO Cheie robinet radiator
- F Clé de montage étagee
- I Cricchetto di tipo interno
- E Llave carraca radiadores
- CN 穿心棘轮扳手

1/2" 12.5 mm CrV 30T



for / dla: YT-03316

TIED ON CARD

YATO		
YT-03315	1/2" (12.7 mm)	6/24

- GB Step wrench
- D Stufenschlüssel
- PL Klucz stopniowy
- RUS Калибратор FORA для металлопластиковых труб
- CZ Klíč na radiátorové šroubení
- H Lépcsős radiátor kulcs
- RO Cheie in trepte pt. radiator
- F Clé de montage étagee
- I Chiave a cricco
- E Llave de radiadores
- CN 散熱六角階梯扳手

1/2" 12.5 mm 3/8" 29/68" 1/2" 21/32" 27/32" 9.6 mm 11.6 mm 12.6 mm 16.4 mm 21 mm



POLYBAG WITH HEADER

for / dla: YT-03315

YATO		
YT-03316	1/2" (12.7 mm)	100

- GB** PVC pipe cutter
D PVC Rohrabsschneider
PL Obcinak do rur PCV
RUS Труборез для ПВХ труб
CZ Řezač PVC trubek
H Csővágó olló PVC csövekhez
RO Clește pt. tăiat țevi din PVC
F Coupeur aux tubes
I Taglia tubi PVC
E Cortatubos PVC
CN PVC 管子割刀



∅ max (mm) **35** PEX AL PEX PVC PP PU PE 8Cr13 STAINLESS STEEL STAL NIERDZEWNA HRC 54

SLIDING CARD

YATO	max. ∅ (mm)	
YT-2230	35	6/48

- GB** PVC pipe cutter
D PVC Rohrabsschneider
PL Obcinak do rur PCV
RUS Труборез для ПВХ труб
CZ Řezač PVC trubek
H Csővágó olló PVC csövekhez
RO Clește pt. tăiat țevi din PVC
F Coupeur aux tubes
I Taglia tubi PVC
E Cortatubos PVC
CN PVC 管子割刀



∅ max (mm) **42** PEX AL PEX PVC PP PU PE 8Cr13 STAINLESS STEEL STAL NIERDZEWNA HRC 54 RATCHET SYSTEM ZAPADKOWY QUICK RELEASE SZYBKIE ZWALNIANIE

SLIDING CARD

YATO	max. ∅ (mm)	
YT-2231	42	6/48

- GB** PVC pipe cutter
D PVC Rohrabsschneider
PL Obcinak do rur PCV
RUS Труборез для ПВХ труб
CZ Řezač PVC trubek
H Csővágó olló PVC csövekhez
RO Clește pt. tăiat țevi din PVC
F Coupeur aux tubes
I Taglia tubi PVC
E Cortatubos PVC
CN PVC 管子割刀



∅ max (mm) **63** PEX AL PEX PVC PP PU PE 8Cr13 STAINLESS STEEL STAL NIERDZEWNA HRC 56-58 RATCHET SYSTEM ZAPADKOWY QUICK RELEASE SZYBKIE ZWALNIANIE

SLIDING CARD

YATO	max. ∅ (mm)	
YT-2232	63	6/24

- GB** PVC pipe cutter
D PVC Rohrabsschneider
PL Obcinak do rur PCV
RUS Труборез для ПВХ труб
CZ Řezač PVC trubek
H Csővágó olló PVC csövekhez
RO Clește pt. tăiat țevi din PVC
F Coupeur aux tubes
I Taglia tubi PVC
E Cortatubos PVC
CN PVC 管子割刀



SLIDING CARD

PEX AL PEX PVC PP PU PE 8Cr13 STAINLESS STEEL STAL NIERDZEWNA HRC 54 AI RATCHET SYSTEM ZAPADKOWY QUICK RELEASE SZYBKIE ZWALNIANIE

∅ max (mm) **51**

YATO	max. ∅ (mm)	
YT-2228	51	6/24



∅ max (mm) **64**

YATO	max. ∅ (mm)	
YT-2229	64	6/24

- GB** Pipe cutter
D Rohrabsschneider
PL Obcinak do rur
RUS Труборез для труб
CZ Řezač trubek
H Csővágó olló csövekhez
RO Clește pt. tăiat țevi
F Coupeurs aux tubes
I Rullo di taglio per tubi
E Cortatubos
CN 管子割刀

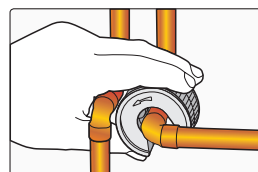

PEX PLASTIC Al, Cu BEARING STEEL STAL ŁOŻYSKOWA

SLIDING CARD

YATO	∅	external diameter / średnica zewnętrzna (mm)	
YT-22353	19/32" (15 mm)	48	5/50
YT-22354	23/32" (18 mm)	59	10/50
YT-22355	7/8" (22 mm)	56	10/50

GB Pipe cutter CZ Řezač trubek F Coupeur aux tubes
 D Rohrschneider H Csővágó olló I Taglia tubi PVC
 PL Obcinak do rur RO Clește pt. țăiat țevi E Cortatubos
 RUS Труборіз для труб CN 管子割刀

COLOR BOX



PEX



PLASTIC Al, Cu Ø 1/10"-7/8"
 Ø 3-22 mm BEARING STEEL STAL ŁOŻYSKOWA

YATO	Ø	
YT-22318	1/10"-7/8" (3-22 mm)	100



PLASTIC Al, Cu Ø 1/10"-5/4"
 Ø 3-32 mm QUICK-ADJUSTMENT SZYBKONASTAWNY WITH DEBURRER Z GRATOWNIKIEM BEARING STEEL STAL ŁOŻYSKOWA SPARE CUTTING WHEEL ZAPASOWE KÓŁKO TNĄCE

YATO	Ø	
YT-22338	1/10"-5/4" (3-32 mm)	50



PLASTIC Al, Cu Ø 3/8"-1-5/8"
 Ø 10-40 mm BEARING STEEL STAL ŁOŻYSKOWA

YATO	Ø	
YT-2232	3/8"-1-5/8" (10-40 mm)	20



PLASTIC Al, Cu Ø 1/4"-7/4"
 Ø 6-45 mm WITH DEBURRER Z GRATOWNIKIEM BEARING STEEL STAL ŁOŻYSKOWA SPARE CUTTING WHEEL ZAPASOWE KÓŁKO TNĄCE

YATO	Ø	
YT-2233	1/4"-7/4" (6-45 mm)	25



PLASTIC Al, Cu Ø 1/2"-5/2"
 Ø 14-63 mm QUICK-ADJUSTMENT SZYBKONASTAWNY BEARING STEEL STAL ŁOŻYSKOWA SPARE CUTTING WHEEL ZAPASOWE KÓŁKO TNĄCE

YATO	Ø	
YT-2234	1/2"-5/2" (14-63 mm)	25



PLASTIC Al, Cu Ø 2"-5"
 Ø 50-127 mm QUICK-ADJUSTMENT SZYBKONASTAWNY BEARING STEEL STAL ŁOŻYSKOWA

YATO	Ø	
YT-2235	2"-5" (50-127 mm)	10

GB Replacement cutting wheel for pipe cutters
 D Ersatzschneidrad für Rohrschneider
 PL Zapasowe kółko tnące do obcinaka do rur
 RUS Запасной режущий диск для труборезов
 CZ Náhradní řezné kolečko na trubky frézy

H Tartalék vágókerék cső vágó
 RO Roata de schimb pt. taiere țevi
 F Molette pour coupe
 I Taglio ruote tubo taglierina
 E Rueda de corte de repuesto para cortatubos
 CN 管子割刀刀片

2 PCS



DOUBLE BLISTER

YATO	a (mm)	b (mm)	c (mm)	for/dla:	
YT-22313	18	6	4.8	YT-2233	50/300
YT-22314	26	14	7.5	YT-2232	6/108
YT-22315	18	6	4.8	YT-22338	50/300
YT-22316	27	6.3	5	YT-2234	24/288

GB Replacement cutting wheel for pipe cutters
 D Ersatzschneidrad für Rohrschneider
 PL Zapasowe kółko tnące do obcinaka do rur
 RUS Запасной режущий диск для труборезов
 CZ Náhradní řezné kolečko na trubky frézy

H Tartalék vágókerék cső vágó
 RO Roata de schimb pt. taiere țevi
 F Molette pour coupe
 I Taglio ruote tubo taglierina
 E Rueda de corte de repuesto para cortatubos
 CN 管子割刀刀片

BEARING STEEL STAL ŁOŻYSKOWA

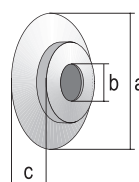

DOUBLE BLISTER

YATO	a (mm)	b (mm)	c (mm)	for/dla:	
YT-22317	44	10.6	8	YT-2235	12/144

GB Standard two handed bender
D Standard-Zweihand-Bieger
PL Giętarka do rur
RUS Стандартный двуручный трубогиб

CZ Standardní dvouruční ohýbačka
H Kétkezes hajlító
RO Dispozitiv de indoit teava
F Cintreuse aux tubes

I Tubo manuale bender
E Curvadoras manuales de tubos
CN 弯管器

180°

Al, Cu

SOFT STEEL
MIĘKKA STAL
COPPER
MOSIĄDZ

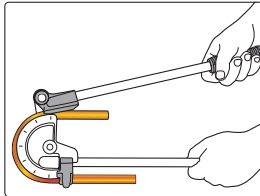
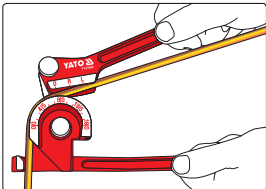

WHITE
CARTON BOX
& COLOR LABEL

YATO	Ø	COLOR BOX
YT-21840	1/4" (6.3 mm); 5/16" (8 mm); 3/8" (10 mm)	20

YATO	Ø	COLOR BOX
YT-21842	15/32" (12 mm)	20
YT-21843	9/16" (14 mm)	10
YT-21844	9/32" (15 mm)	10
YT-21845	5/8" (16 mm)	10
YT-21846	23/32" (18 mm)	10

GB Internal pipe bending spring
D Innen-Rohrbiegefeder
PL Sprężyna wewnętrzna do gięcia rur
RUS Пружина для изгиба металлопластиковых труб, внутренняя
CZ Pružina pro ohýbání trubek vnitřní

H Belső cső hajlító rugó
RO Arc indoire pt. tevi flexibile
F Ressort de cintrage intérieur
I Curvatubi molla interna
E Muelle curvado interior para tubo
CN 倪奪粟銅

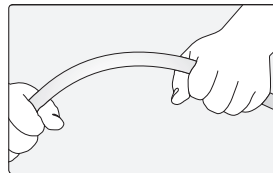

PEX
AL
PEX

76
cm

FLAT
PROFILE
PLASKI
PROFIL

ZINC
PLATED
CYNKOWANA



YATO	external pipe diameter / zewnętrzna średnica rury (mm)	COLOR BOX
YT-21850	16	25
YT-21851	20	25
YT-21852	25-26	25

11

GB Hand flaring tools set
D Handpresse zum Aufweiten von Rohren
PL Praska do ręcznego rozszerzania rur
RUS Пресс для ручного расширения труб

CZ Přípravek na ruční rozšiřování konců trubek
H Kézi csőtágító
RO Presă manuală pt. lățirea țevilor
F Set pour étendre les tubes

I Presa per tubi
E Prensa para la elongación manual de tubos
CN 扩孔器组套

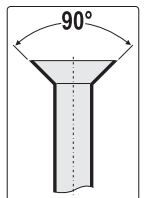

COLOR BOX



BMC & COLOR SLEEVE



YATO	Ø (mm)	COLOR BOX
YT-2182	22; 25; 28	20

YATO	Ø (mm)	COLOR BOX
YT-2180	3; 5; 6; 8; 10; 12; 14; 15; 16; 19	10

GB Pipe calibration tool with reamer
D Kalibrierer mit Entgrater für Mehrschichtverbundrohr
PL Kalibrator z gratownikiem
RUS Калибратор пластиковый с фаскоснимателем
CZ Kalibrator na trubky
H Ötrétegű cső kalibráló
RO Calibrator teava multistrat
F Calibreur ébavureur intérieur de tubes multicouches
I Calibratore tubo con deburrer
E Calibrador para tubos multicapa
CN 内外倒角整圆器

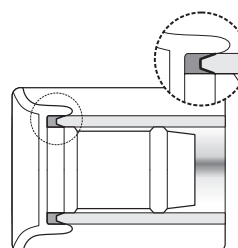

PEX
AL
PEX

WITH DEBURRER
Z GRATOWNIKIEM



TIED
ON CARD

YATO	pipe diameter / średnica rury (mm)	COLOR BOX
YT-22373	16; 20; 25	200
YT-22374	16; 20; 26	200

- GB Gas torch
- D Gasbrenner
- PL Palnik gazowy
- RUS Газовая паяльная лампа
- CZ Plynový hořák
- H Gázégő
- RO Arzător de gaz
- F Brûleur à gaz
- I Saldatore bruciatore a gas
- E Soplete de gas
- CN 火焰枪



PIEZO	30 ml	60-90 min	GAS GAZ
LOCK BLOKADA	BUTANE lighter gas BUTAN (gas de aprănzică)	CHILD PROTECTION (ZABEZPEČENIE PŘED DĚTMI)	

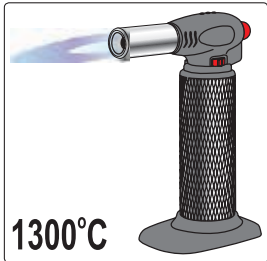

1300°C

DOUBLE BLISTER



YATO	
YT-36700	10/20

- GB Soldering tool set
- D Gaslötkolben satz
- PL Lutownica gazowa z akcesoriami
- RUS Газовый паяльный набор
- CZ Plynova pajka souprava
- H Gaz forrasztópaka készletek
- RO Set ciocan de lipit cu gaz
- F Fer à souder à gaz
- I Saldatore a gas
- E Soldador a gas con accesorios
- CN 自动点火多功能瓦斯组套

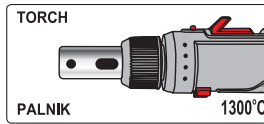
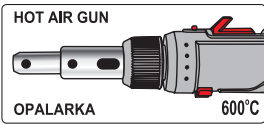
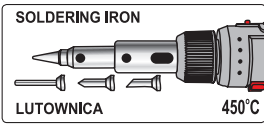

7 PCS	30-125 W	30 ml	75 min
GAS GAZ	PIEZO	LOCK BLOKADA	BUTANE lighter gas BUTAN (gas de aprănzică)
			CHILD PROTECTION (ZABEZPEČENIE PŘED DĚTMI)

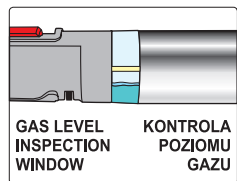

GAS LEVEL INSPECTION WINDOW KONTROLA POZIOMU GAZU

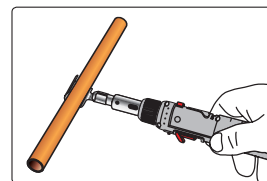

PLASTIC BOX & HANGING COLOR BOX



YATO	W
YT-36706	30-125 6

- GB Soldering tool 3 in 1
- D Gaslötkolben 3 in 1
- PL Lutownica gazowa 3 w 1
- RUS Газовый паяльник 3-в-1
- CZ Plynova pajka 3 in 1
- H Gaz-forrasztópaka 3 in 1
- RO Ciocan de lipit cu gaz 3 in 1
- F Fer à souder à gaz
- I Saldatore a gas
- E Soldador de gas 3 in 1
- CN 瓦斯焊接工具



PIEZO	30~70 W	12 ml	60 min
LOCK BLOKADA	BUTANE lighter gas BUTAN (gas de aprănzică)	PROPANE-BUTANE lighter gas PROPAN-BUTAN (gas de aprănzică)	CHILD PROTECTION (ZABEZPEČENIE PŘED DĚTMI)

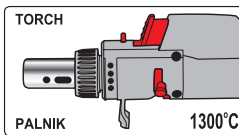
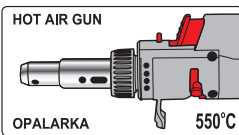
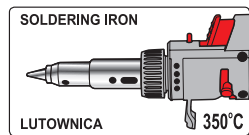

GAS LEVEL INSPECTION WINDOW KONTROLA POZIOMU GAZU

SLIDING CARD



YATO	W
YT-36704	30-70 12/72

- GB Gas blow torch
- D Lötlbrenner
- PL Palnik gazowy
- RUS Газовая горелка
- CZ Plynový hořák
- H Gázégő
- RO Arzător de gaz
- F Brûleur à gaz
- I Saldatore bruciatore a gas
- E Soplete de gas
- CN 火焰枪

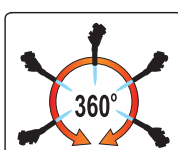
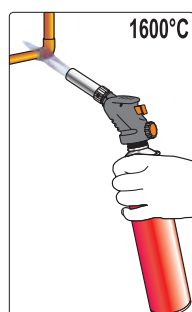

EURO TYPE EN417



PIEZO	1.28 kW	GAS GAZ	AIR POWETRZE	LOCK BLOKADA	BUTANE BUTAN
-------	---------	---------	--------------	--------------	--------------

SLIDING CARD



YATO	kW
YT-36709	1.28 6/12

- GB** PVC plastic pipe welder
D Schweißgerät für thermoplastische Rohre
PL Zgrzewarka do rur termoplastycznych
RUS Сварочная машина для термопластиковых труб
CZ Svářecíka na termoplastické trubky
H Hegesztő berendezés termoplasztikus csövekhez
RO Masina de sudat tevi termoplastice
F Soudeur en tuyauterie en PVC
I Polifusore saldatore per tubi
E Máquina de soldar las tubos termoplásticos
CN 热熔器



230V~50Hz
850 W
0-300°C
Ø 16, 20, 25, 32 [mm]
40, 50, 63

METAL CASE & COLOR BOX

YATO	W	
YT-82250	850	2

- GB** Crimping pliers for PEX-AL-PEX pipes
D Crimpzange für die Verbindungen an den Rohren
PL Praska do zaciskania złączek PEX-AL-PEX
RUS Пресс-клещи для металлопластиковых труб
CZ Lisovací kleště pro trubky PEX-AL-PEX
H PEX-AL-PEX krimpelő eszköz
RO Clește de sertizare pt. țevi PEX-AL-PEX
F Pince des joints de raccordement des tuyaux PEX-AL-PEX
I Pressa pex tubo di piegatura
E Crimpadora para los tubos PEX-AL-PEX
CN 液压压管钳

9 PCS
PE-RT AL PE-RT
PEX AL PEX
U 16mm
U 20mm
U 25mm
U 32mm
6t =60kN
TH 16mm
TH 20mm
TH 26mm
TH 32mm

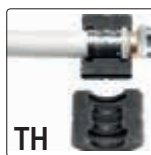

BMC & COLOR SLEEVE

YATO	
YT-21735	2

- GB** Spare die for crimping pliers
D Ersatz Matrize für Presswerkzeug
PL Matryca zapasowa do zaciskarki
RUS Вкладыши для пресс-инструмента
CZ Vyměnné čelisti
H Présfógók
RO Capete de presare pt. inele interschimbabile
- F** Matrices empreinte pour pince
I Dies ricambo
E Que prensa de troquel para crimpadora
CN 压管模块

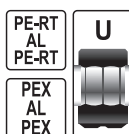

- GB** Hinged pipe vice
D Rohrschraubstock
PL Imadło zaciskowe do rur
RUS Тиски для труб
CZ Upínací svěrák na trubky
H Satu, csőszorító
- RO** Menghină pt. țevi
F Étau de serrage à tuyaux
I Morsa stringi tubo
E Tornillo de apriete para tubos
CN 管子台虎钳

S55C



for / dla: YT-21735

POLYBAG WITH HEADER

YATO	size / rozmiar U (mm)	
YT-21740	16	50
YT-21741	20	100
YT-21742	25	100
YT-21743	32	100

- GB** Spare die for crimping pliers
D Ersatz Matrize für Presswerkzeug
PL Matryca zapasowa do zaciskarki
RUS Вкладыши для пресс-инструмента
CZ Vyměnné čelisti
H Présfógók
RO Capete de presare pt. inele interschimbabile
- F** Matrices empreinte pour pince
I Dies ricambo
E Que prensa de troquel para crimpadora
CN 压管模块

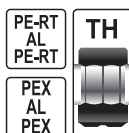

for / dla: YT-21735

POLYBAG WITH HEADER

YATO	size / rozmiar TH (mm)	
YT-21744	16	50
YT-21745	20	50
YT-21746	26	100
YT-21747	32	100



COLOR BOX

YATO	Ø (mm)	
YT-6510	60	4
YT-6511	76	2
YT-6512	90	2
YT-6513	110	1

GB Universal quick deburrer
D Universal-Schnell-Entgrater
PL Gratownik
RUS Универсальный быстро граatosниматель
CZ Univerzální rychlé odhrotování
H Univerzális gyors sorjátlanító

RO Debavurator rapid universal
F Ebavureur
I Utensile di sbavatura
E Desbarbador rápida universal
CN 去毛刺修边器

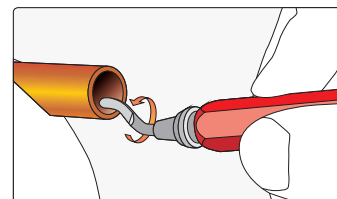

HSS M2

BODY KORPUS
 Ø12 mm

EXCHANGEABLE ROTATING BLADE
 WYMIENNE OBRACANE OSTRZE

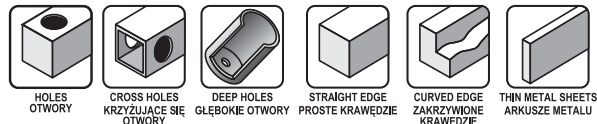

SLIDING CARD

YATO	
YT-22360	50/150

GB Replacement blade for deburrer
D Ersatzklinge für Entgrater
PL Ostrza zapasowe do gratownika
RUS Лезвие для снятия заусенцев
CZ Náhradní čepel pro odhrotování
H Tartalék penge sorjázásához
RO Cuitit de schimb pt. debavurare
F Set le lames pour ébavureur
I Set di lame per sbavatura utensile
E Cuchilla de repuesto para desbarbar
CN 修边器刀片

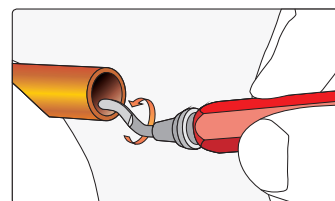
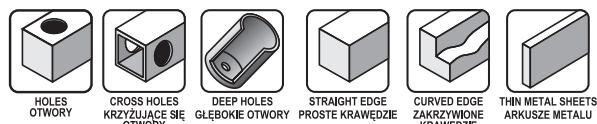

10 PCS

HSS M2

UNIVERSAL SHAPE
 UNIVERZALNY KSZTAŁT

EXCHANGEABLE ROTATING BLADE
 WYMIENNE OBRACANE OSTRZE

for / dla: YT-22360

SLIDING CARD

YATO	
YT-22361	12/144

11

GB Copper pipe internal brush
D Kupferrohr Innenbürste
PL Szczotka wewnętrzna do rur miedzianych
RUS Щетка для внутренней очистки труб
CZ Kartač vnitřní na měděné trubky
H Rézcső belső tisztító kefe
RO Perii de interior pt. tevi de cupru

F Brosse aux tubes en cuivre
I Spazzola per il rame interno
E Cepillo para limpieza de tubos de cobre
CN 管子刷

STAINLESS STEEL WIRE
 DRUT ZE STALI
 NIERDZEWNEJ

GB Copper pipe brush 2 in 1
D 2-in-1 Kupferrohrbürste für Innen- und Außenreinigung
PL Szczotka do rur miedzianych 2 w 1
RUS Щетка для внутренней и внешней зачистки медных труб
CZ Kartač vnitřní a vnější na měděné trubky

H Rézcső tisztító kefe 2 in 1
RO Perii pt. tevi de cupru 2 in 1
F Brosse aux tubes en cuivre
I Spazzola per il tubi di rame 2 in 1
E 2-en-1 cepillo para limpieza de tubos de cobre int. y ext
CN 2合1管子刷

STAINLESS STEEL WIRE
 DRUT ZE STALI
 NIERDZEWNEJ



YATO	Ø (mm)	
YT-63701	15	12/120
YT-63702	18	12/120
YT-63703	22	12/120
YT-63704	28	12/120

YATO	Ø (mm)	
YT-63705	15; 22	50/100

SLIDING CARD

GB Cleaning pad set for copper pipes
D Reinigungsvlies-satz für kupferrohre
PL Włóknina do czyszczenia rur miedzianych
RUS Губка абразивная
CZ Brusné rouno
H Tisztítószivacs

RO Burete abraziv
F Tampons de nettoyage
I Fibra abrasiva per la pulizia de tubo di rame
E Almohadilla abrasiva
CN 件套工业洁

10 PCS

75x130 mm

FOR PIPES DO RUR
Cu

METAL FREE
 NIE ZAWIERA METALU

DRY WORK
 PRACA NA SUCHO

WET WORK
 PRACA NA MOKRO

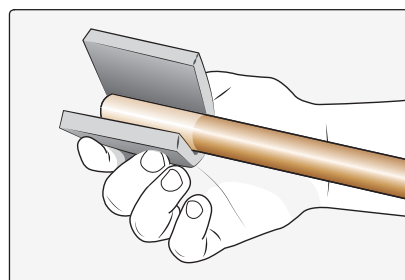

COLOR SLEEVE

YATO	size / rozmiar (mm)	
YT-63740	75x130	50



GB Tool box
D Werkzeugkasten
PL Skrzynka narzędziowa
RUS Инструментальный ящик
CZ Skříňka na nářadí
H Szerszámós láda

RO Cutie de scule
F Boîte à outils
I Cassetta degli attrezzi
E Caja de herramientas
CN 工具箱

WHITE
CARTON BOX
& COLOR LABEL

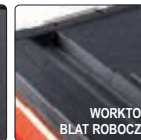

RUBBER CORNER
GUMOWY NAROŻNIK

WORKTOP
BLAT ROBOCZY



390x215x130 mm
max 10 kg



390x215x60 mm
max 5 kg

390x215x60 mm
max 5 kg

YATO	drawers / szuflady	
YT-09108	1	2

YATO	drawers / szuflady	
YT-09107	2	2

GB Tool trolley
D Werkzeugkasten
PL Wózek narzędziowy 3-częściowy
RUS Тележка инструментальная
CZ Vozík na nářadí
H Szerszám kocsi
RO Instrument cărucior
F Servante d'atelier
I Armadio per utensili
E Herramienta carro
CN 工具箱



WHITE
CARTON BOX
& COLOR LABEL

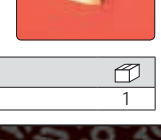
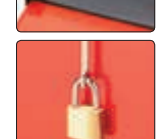
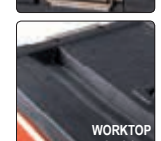

WORKTOP
BLAT ROBOCZY

MODULES
PROTECTION

ZABEZPIECZENIE
MODUŁÓW

RUBBER CORNER
GUMOWY NAROŻNIK



420x220x150 mm
max 20 kg

390x215x130 mm
max 10 kg

410x210x280 mm
max 15 kg

420x220x150 mm
max 20 kg

390x215x60 mm
max 5 kg

390x215x60 mm
max 5 kg

410x210x280 mm
max 15 kg



YATO	
YT-09102	1

YATO	
YT-09101	1

- GB** Drawer insert / Tool set for plumbers
- D** Schubladeneinlage / Werkzeug-Set für Klempner
- PL** Wkład do szuflady / Zestaw narzędziowy dla hydraulików
- RUS** Вклад в выдвижном ящику / Набор инструментов для водопроводчик
- CZ** Vložka do zásuvky / Sada nářadí pro instalatér
- H** Fiókbetét / Szerszámkészlet vízvezeték-szerelő

- RO** Adaos la sertar / Set de instrumente pt. instalator
- F** Module plastique pour servante / Un ensemble d'outils pour les plombier
- I** Tenone per l'armadio / Tool set per idraulici
- E** Accesorio de cajón / Un conjunto de herramientas para fontanero
- CN** 水管工具组套



PLASTIC TRAY & COLOR LABEL



- 250 mm;
- 330 mm;
- 250 mm;
- 15 m x 19 mm

- 250 mm;
- 250 mm;
- 300 mm;
- 3-32 mm;
- 10 m x 12 mm

- 63 mm;
- 6-45 mm;
- 15 m x 22 mm;
- 10 m x 12 mm;
-

4 PCS **CrV** **CrMo**

5 PCS **CrV** **CrMo**

5 PCS **HSS** **8CrB**

YATO YT-55480 5

YATO YT-55481 5

YATO YT-55482 5

Memo

Large grid area for notes or memo.

Memo

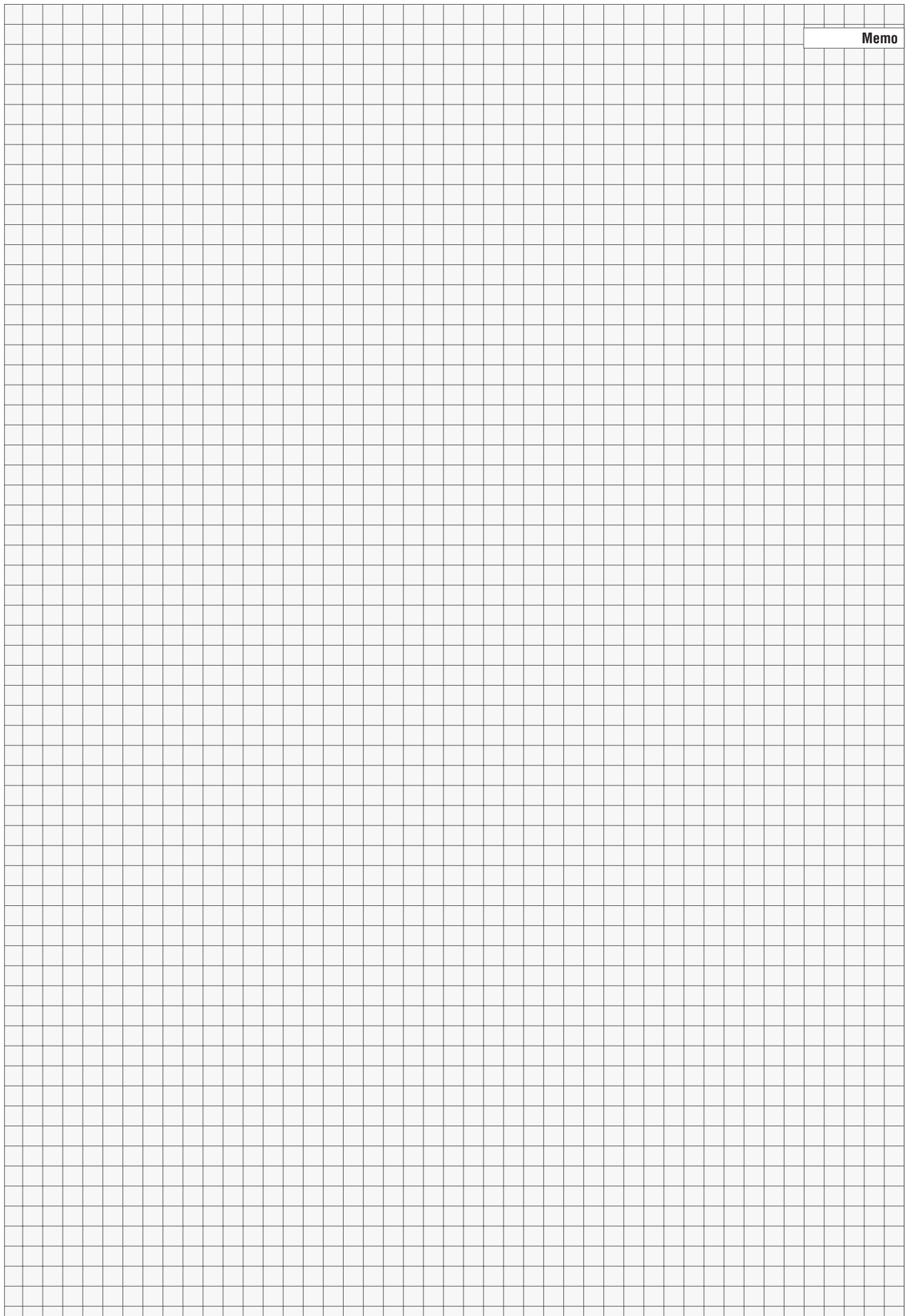

12

Fastening tools Narzędzia do łączenia



Hand riveters & rivet nuts
Nitownice ręczne i nitonakrętki



212-214

Hand riveters
Nitownice ręczne..... 212
Hand riveting tools
Nitownice ręczne, dźwigniowe..... 212
Hand nut tools
Nitownice do nitonakrętek..... 213
Threaded rivet nuts
Nitonakrętki..... 214

Pneumatic riveters
Nitownice pneumatyczne



214

Pliers for hollow expansion bolts
Zaciskarki do kołków typu Molly



215

Staple guns & staples
Zszywacze i zszywki



215-216

Staple guns
Zszywacze..... 215
Staple removers
Rozszywacze..... 216
Staples
Zszywki..... 216
Nails
Gwoździe..... 216

Pneumatic stitching & nailing machines
Zszywacze i gwoździarki pneumatyczne



216-217

Pneumatic staplers
Zszywacze pneumatyczne..... 216
Pneumatic nailers
Gwoździarki pneumatyczne..... 217
Staples
Zszywki..... 217
Nails
Gwoździe..... 217

Foam guns
Pistolety do pianki



218

Caulking guns
Wyciskacze do mas



218

Burners & soldering tools
Palniki i lutownice



219-220

Glue guns
Pistolety do klejenia



221

Glue sticks
Wkłady klejowe



221

GB Hand riveter
D Blindnietzange
PL Nitownica ręczna
RUS Заклепочник
CZ Ruční nýtovačka
H Kézi pöpszegecsűzö

RO Presă de nituit manuală
F Riveteuse manuelle
I Rivettatrice manuale
E Remachadora de mano
CN 拉柳枪

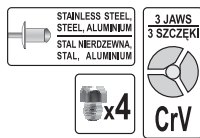

3 JAWS
3 SZCEKI

CrV

280 mm



DOUBLE BLISTER

YATO	Ø (mm)	L (mm)	Box
YT-3600	2.4; 3.2; 4.0; 4.8	280	6/24

GB Hand riveter
D Blindnietzange
PL Nitownica ręczna
RUS Заклепочник
CZ Ruční nýtovačka
H Kézi pöpszegecsűzö

RO Presă de nituit manuală
F Riveteuse manuelle
I Rivettatrice manuale
E Remachadora de mano
CN 拉柳枪

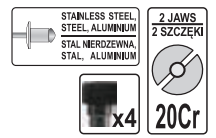

2 JAWS
2 SZCEKI

20Cr

250 mm



DOUBLE BLISTER

YATO	Ø (mm)	L (mm)	Box
YT-36007	2.4; 3.2; 4.0; 4.8	250	6/24

GB Hand riveter
D Blindnietzange
PL Nitownica ręczna
RUS Заклепочник
CZ Ruční nýtovačka
H Kézi pöpszegecsűzö

RO Presă de nituit manuală
F Riveteuse manuelle
I Rivettatrice manuale
E Remachadora de mano
CN 拉柳枪



3 JAWS
3 SZCEKI

CrMo

200 mm



COLOR BOX

YATO	Ø (mm)	L (mm)	Box
YT-36012	2.4; 3.2; 4.0; 4.8	200	30

GB Hand riveter
D Blindnietzange
PL Nitownica ręczna
RUS Заклепочник
CZ Ruční nýtovačka
H Kézi pöpszegecsűzö
RO Presă de nituit manuală
F Riveteuse manuelle
I Rivettatrice manuale
E Remachadora de mano
CN 拉柳枪

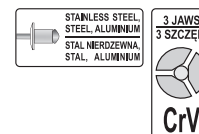

3 JAWS
3 SZCEKI

CrV

253 mm

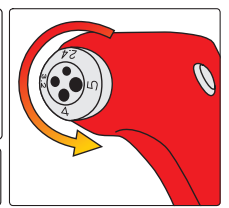

SLIDING CARD

YATO	Ø (mm)	L (mm)	Box
YT-36011	2.4; 3.2; 4.0; 4.8	253	12/36

GB Lazy tongue riveter
D Blindnietzange
PL Nitownica przemysłowa harmonijkowa czolowa
RUS Заклепочник промышленный
CZ Nýtovačka harmoniková čelná
H Harmónikás pöpszegecsűzö homlok
RO Presă de nituit armonică - frontală

F Pince riveter extensible
I Rivettatrice frontale a fisarmonica industriale
E Remachadora perezoso tong
CN 重型伸缩拉柳枪



3 JAWS
3 SZCEKI

250-810 mm

x5

CrMo



COLOR BOX

YATO	Ø (mm)	L (mm)	Box
YT-36060	2.4; 3.2; 4.0; 4.8; 6.4	250-810	10

GB Hand riveting tool
D Blindnietzange
PL Nitownica dźwigniowa
RUS Заклепочник
CZ Nýtovačka páková
H Emelyűs pöpszegecsűzö
RO Pclește pt. popnrituri

F Riveteuse à levier
I Rivettatrice per rivetti a strappo
E Remachadora de palanca
CN 双把手拉柳枪

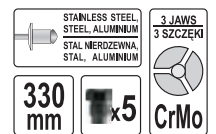

3 JAWS
3 SZCEKI

330 mm

x5

CrMo



COLOR BOX

YATO	Ø (mm)	L (mm)	Box
YT-3609	3.2; 4.0; 4.8; 6.0; 6.4	330	16

GB Hand riveting tool
D Blindnietzange
PL Nitownica dźwigniowa
RUS Заклепочник
CZ Nýtovačka páková
H Emelyűs pöpszegecsűzö
RO Pclește pt. popnrituri
F Riveteuse à levier
I Rivettatrice per rivetti a strappo
E Remachadora de palanca
CN 双把手拉柳枪

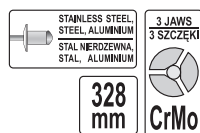

328 mm

CrMo

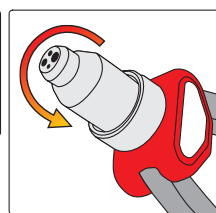

COLOR BOX

YATO	Ø (mm)	L (mm)	Box
YT-36092	3.2; 4.0; 4.8; 6.4	328	12

GB Hand riveting tool
D Blindnietzange
PL Nitownica dźwigniowa
RUS Заклепочник
CZ Nýtovačka páková
H Emelyűs pöpszegecsűzö
RO Pclește pt. popnrituri

F Riveteuse à levier
I Rivettatrice per rivetti a strappo
E Remachadora de palanca
CN 双把手拉柳枪



3 JAWS
3 SZCEKI

380 mm

x5

CrMo



COLOR BOX

YATO	Ø (mm)	L (mm)	Box
YT-36095	2.4; 3.2; 4.0; 4.8; 6.4	380	12

GB Hand riveting tool
D Blindnietzange
PL Nitownica ręczna do nitonakrętek
RUS Заклепочник
CZ Nýtovačka páková
H Emeltyűs
RO Pclește pt. popnituri

F Riveteuse à levier
I Rivettatrice per rivetti a strappo
E Remachadora de palanca
CN 双把手拉铆枪

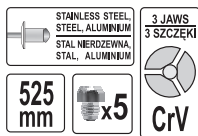

COLOR BOX



YATO	Ø (mm)	L (mm)	
YT-3610	3.2; 4.0; 4.8; 6.0; 6.4	525	12

GB Hand nut tool
D Blindnietzange
PL Nitownica ręczna do nitonakrętek
RUS Заклепочник
CZ Nýtovačka páková
H Emeltyűs pöpszegecsűző
RO Pclește pt. popnituri
F Riveteuse manuelle aux écrous
I Rivettatrice mano rivetto
E Remachadora de palanca
CN 手动铆螺母枪



YATO	size / rozmiar	L (mm)	
YT-36140	M3; M4; M5; M6	200	20

GB Hand nut tool
D Blindnietzange
PL Nitownica ręczna do nitonakrętek
RUS Заклепочник
CZ Nýtovačka páková
H Emeltyűs pöpszegecsűző
RO Pclește pt. popnituri

F Riveteuse manuelle aux écrous
I Rivettatrice mano rivetto
E Remachadora de palanca
CN 手动铆螺母枪



YATO	size / rozmiar	L (mm)	
YT-36112	M3; M4; M5; M6; M8	300	20

GB Hand nut tool
D Blindnietzange
PL Nitownica ręczna do nitonakrętek
RUS Заклепочник
CZ Nýtovačka páková
H Emeltyűs pöpszegecsűző
RO Pclește pt. popnituri

F Riveteuse manuelle aux écrous
I Rivettatrice mano rivetto
E Remachadora de palanca
CN 手动铆螺母枪



YATO	size / rozmiar	L (mm)	
YT-3612	M5; M6; M8; M10; M12	330	5

GB Hand nut tool
D Blindnietzange
PL Nitownica ręczna do nitonakrętek
RUS Заклепочник
CZ Nýtovačka páková
H Emeltyűs pöpszegecsűző
RO Pclește pt. popnituri

F Riveteuse manuelle aux écrous
I Rivettatrice mano rivetto
E Remachadora de palanca
CN 手动铆螺母枪



YATO	size / rozmiar	L (mm)	
YT-36119	M5; M6; M8; M10; M12	338	6

GB Hand nut tool
D Blindnietzange
PL Nitownica ręczna do nitonakrętek
RUS Заклепочник
CZ Nýtovačka páková
H Emeltyűs pöpszegecsűző
RO Pclește pt. popnituri

F Riveteuse manuelle aux écrous
I Rivettatrice mano rivetto
E Remachadora de palanca
CN 手动铆螺母枪



YATO	size / rozmiar	L (mm)	
YT-36127	M3; M4; M5; M6; M8; M10; M12	360	12

GB Hand nut tool
D Blindnietzange
PL Nitownica ręczna do nitonakrętek
RUS Заклепочник
CZ Nýtovačka páková
H Emeltyűs pöpszegecsűző
RO Pclește pt. popnituri

F Riveteuse manuelle aux écrous
I Rivettatrice mano rivetto
E Remachadora de palanca
CN 手动铆螺母枪

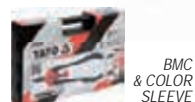

YATO	size / rozmiar	L (mm)	
YT-36128	M3; M4; M5; M6; M8; M10; M12	360	6

GB Hand nut tool
D Blindnietzange
PL Nitownica ręczna do nitonakrętek
RUS Заклепочник
CZ Nýtovačka páková
H Emeltyűs pöpszegecsűző
RO Pclește pt. popnituri

F Riveteuse manuelle aux écrous
I Rivettatrice mano rivetto
E Remachadora de palanca
CN 手动铆螺母枪

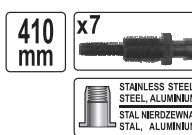

YATO	size / rozmiar	L (mm)	
YT-36129	M5; M6; M8; M10; M12	410	5

GB Threaded aluminum rivet nuts
D Aluminium blindnietmutter
PL Nitonakrętki aluminiowe
RUS Алюминиевые резьбовые заклепки
CZ Nýtovací matice hliník
H Szegecsanya alumínium

RO Piulite nituibile
F Insert fileté aluminium
I Alluminio dadi per rivetti ciechi
E Tuercas remachadas aluminio
CN 铝制拉铆螺母

20
PCS

AI



POLYBAG WITH HEADER

YATO	size / rozmiar	
YT-36451	M3	125/500
YT-36452	M4	100/400
YT-36453	M5	75/300
YT-36454	M6	50/200

GB Threaded rivet nuts
D Blindnietmutter
PL Nitonakrętki stalowe
RUS Резьбовые заклепки

CZ Nýtovací matice
H Szegecsanya
RO Nituibile
F Insert fileté

I Dadi per rivetti ciechi
E Tuercas remachadas
CN 件套铁制拉铆螺母

20
PCS



POLYBAG WITH HEADER

YATO	size / rozmiar	
YT-36470	M3	125/500
YT-36471	M4	100/400
YT-36472	M5	75/300
YT-36473	M6	50/200
YT-36474	M8	40/160
YT-36475	M10	25/100
YT-36476	M12	15/60

GB Threaded rivet nuts
D Blindnietmutter
PL Nitonakrętki
RUS Резьбовые заклепки

CZ Nýtovací matice
H Szegecsanya
RO Nituibile
F Insert fileté

I Dadi per rivetti ciechi
E Tuercas remachadas
CN 件套铁制拉铆螺母

PLASTIC HANGING BOX



MIX
SIZE
ROZMIARÓW



150
PCS

AI

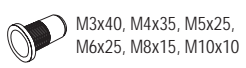

150
PCS

AI

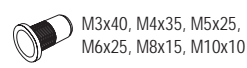

300
PCS

AI

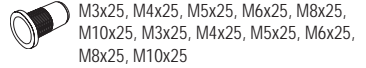

YATO	
YT-36460	24

YATO	
YT-36481	24

YATO	
YT-36480	20

GB Pneumatic riveting machine
D Pneumatische Nietvorrichtung
PL Nitownica pneumatyczna
RUS Пневматический заклепочник
CZ Pneumatická nýtovačka
H Pneumatikus popszegeshűző

RO Presa pneumatica de nituti
F Riveuse pneumatique
I Rivettatrice pneumatica
E Máquina remachadora
CN 气动拉铆枪

STAINLESS STEEL, STEEL, ALUMINIUM
 STAL, NIERDZEWA, STAL, ALUMINIUM

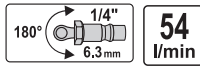

0.70
MPa

54
l/min

x3

x3



$L_{pA} = 83.6 \pm 1.9$ dB;
 $L_{pM} = 97.4 \pm 2.8$ dB;
 $ah = 0.66 \pm 0.21$ m/s²

COLOR BOX



YATO	Ø (mm)	L (mm)	F (kg)	F (N)	
YT-36171	2.4; 3.2; 4.0; 4.8; 5.0	18	1060	10400	10

GB Pneumatic riveting machine
D Pneumatische Nietvorrichtung
PL Nitownica pneumatyczna
RUS Пневматический заклепочник
CZ Pneumatická nýtovačka
H Pneumatikus popszegeshűző

RO Presa pneumatica de nituti
F Riveuse pneumatique
I Rivettatrice pneumatica
E Máquina remachadora
CN 气动拉铆枪

STAINLESS STEEL, STEEL, ALUMINIUM
 STAL, NIERDZEWA, STAL, ALUMINIUM



0.62
MPa

x5



• application: industry
 • przeznaczenie: przemysł

$L_{pA} = 81.2 \pm 3.0$ dB;
 $L_{pM} = 92.1 \pm 3.0$ dB;
 $ah = 0.6 \pm 0.56$ m/s²

COLOR BOX



YATO	Ø (mm)	L (mm)	F (kg)	F (N)	
YT-3618	2.4; 3.2; 4.0; 4.8; 6.4	16	1389	13620	6

GB Pliers for hollow expansion bolts
D Maueranker-Einsetzwerkzeug Satz
PL Zaciskarka do kolków „Molly”
RUS Клещи для дюбелей „Молли”
CZ Kotvící kleště
H Kreater üreges fémdübel

RO Set cleste dibluri
F Pince pour chevilles creux
I Crimpatrice per pioli „Molly”
E Alicates para tacos „Molly”
CN 膨胀螺栓钳组套

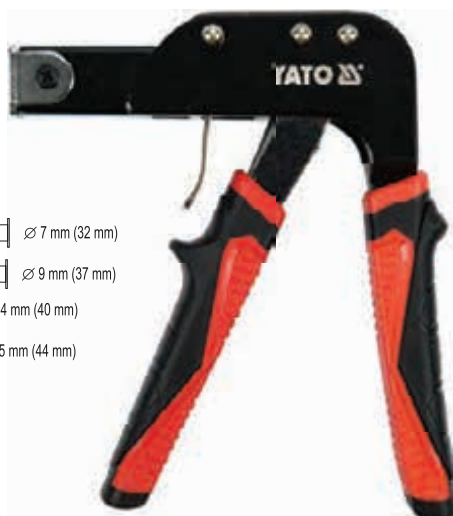
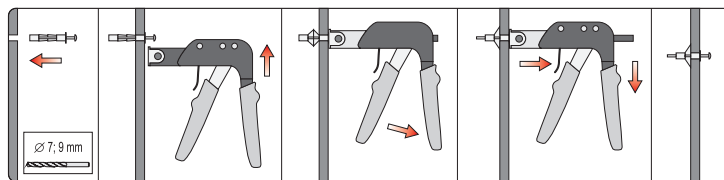

5x ∅ 7 mm (32 mm)
5x ∅ 9 mm (37 mm)
 ∅ 4 mm (40 mm)
 ∅ 5 mm (44 mm)

35x ∅ 7 mm (32 mm)
10x ∅ 9 mm (52 mm)
15x ∅ 9 mm (37 mm)
 ∅ 4 mm (40 mm)
 ∅ 5 mm (58 mm)
 ∅ 5 mm (44 mm)

DOUBLE
BLISTER



60 pcs



PLASTIC
BOX

10 pcs

YATO	
YT-51450	6/24

YATO	
YT-51451	3/12

GB Staple gun
D Tacker
PL Zszywacz tapicerski
RUS Стенлер
CZ Čalounická sešivačka

H Kárpitos tűzőgép
RO Capsator tapiterie
F Agrafeuse tapisserie
CN 打钉枪

DOUBLE
BLISTER



10.6 mm
6-14 mm
1.2 mm 0.52 mm
6.2 mm
10-12 mm
1.2 mm 0.52 mm
2.0 mm
10-14 mm
1.2 mm
6-14 mm 10-12 mm
10-14 mm 14 mm
1.2 mm
14 mm
10-14 mm 14 mm

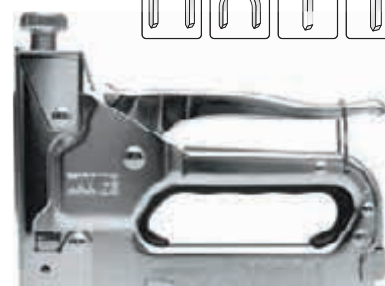

YATO	
YT-7000	12/24

10.6 mm
6-14 mm
1.2 mm 0.52 mm
7.6 mm
10-14 mm
1.2 mm 0.52 mm
2.0 mm
10-14 mm
1.2 mm
6-14 mm 10-14 mm
10-14 mm 14 mm
1.2 mm
14 mm
10-14 mm 14 mm



YATO	
YT-7001	12/24

10.6 mm
6-14 mm
1.2 mm 0.52 mm
2.0 mm
10-14 mm
1.2 mm
6-14 mm
10-14 mm 14 mm
1.2 mm
14 mm
10-14 mm 14 mm



YATO	
YT-7003	6/24

10.6 mm
6-16 mm
1.2 mm
6-16 mm 16 mm
NORMAL-MAX IMPACT FUNCTION



YATO	staples size / rozmiar zszywek (mm)	
YT-7005	10.6x6.0-16.0x1.2	6/24

11.3 mm
4-14 mm
1.2 mm 0.52 mm
6.3 mm
10-12 mm
1.2 mm 0.52 mm
2.0 mm
4-14 mm
10-14 mm 10-14 mm
1.2 mm
10-14 mm 10-14 mm



YATO	
YT-70020	6/24

GB Staple gun
D Tacker
PL Zszywacz tapicerski
RUS Стенпеп
CZ Čalounická sešivačka
H Kárpitos tűzőgép

RO Capsator tapiterie
F Agrafeuse tapisier
I Cucitrice per tappezzerie
E Grapadora de tapicero
CN 打钉枪

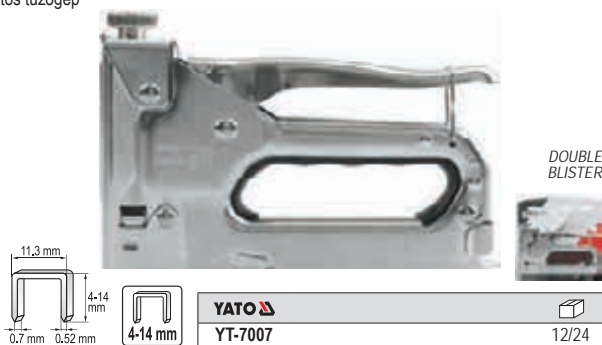
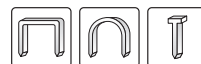

DOUBLE BLISTER

YATO	YT-7007	12/24
-------------	----------------	-------

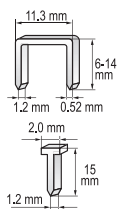

YATO	YT-70021	6/24
-------------	-----------------	------



TRY ME DOUBLE BLISTER

GB Hammer tacker
D Hammer-Tacker
PL Zszywacz młotkowy
RUS Стенпеп

CZ Čalounická sešivačka
H Kárpitos tűzőgép
RO Capsator tapiterie
F Agrafeuse tapisier

I Martello cucitrice
E Grapadora de martillo
CN 钉锤

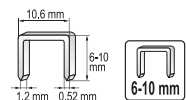

DOUBLE BLISTER

YATO	YT-7004	10/20
-------------	----------------	-------

GB Staple remover
D Klammern abwender
PL Rozszywacz
RUS Скобудалитель
CZ Rozešivač
H Kapocsiszedő
RO Extractor capsă
F Degrafeuse
I Fiocco di rimozione
E Quitagrapas
CN 起钉器



SLIDING CARD

YATO	YT-7011	25/100
-------------	----------------	--------

GB Staples
D Heftklammern
PL Zszywki

RUS Скобы
CZ Sešívky
H Tűzőkapocs

RO Capse tapiterie
F Agrafes
I Punti

E Grapas
CN 码钉

HANGING COLOR BOX

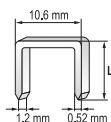

YATO Δ L (mm)	PCS packing	Box
YT-7022	6 1000	50/200
YT-7023	8 1000	50/200
YT-7024	10 1000	50/100
YT-7025	12 1000	50/100
YT-7026	14 1000	50/100

for / dla: YT-7000, YT-7001, YT-7003, YT-7004, YT-7005

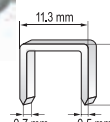

for / dla: YT-7006, YT-7007

YATO Δ L (mm)	PCS packing	Box
YT-7051	6 1000	60/360
YT-7052	8 1000	60/300
YT-7053	10 1000	60/240
YT-7054	12 1000	50/200
YT-7055	14 1000	40/160

GB Nails for staple gun
D Nageln für Yato Tacker
PL Gwoździe do zszywacza
RUS Гвозди для стенпера
CZ Hřebíky na sešivačku
H Szegek a tűzőgéphez

RO Cuie pt. capsator
F Clous pour agrafeuses
I Chiodi per cucitrice
E Clavos para grapadoras
CN 直钉

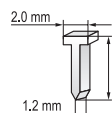
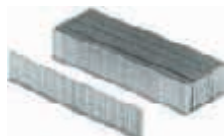

HANGING COLOR BOX

for / dla: YT-7000, YT-7001

YATO Δ L (mm)	PCS packing	Box
YT-7032	10 1000	50/200
YT-7033	12 1000	50/200
YT-7034	14 1000	50/200

GB Pneumatic stitching machine
D Drucklufthefter
PL Zszywacz pneumatyczny
RUS Пневматический шиватель
CZ Pneumatická sešivačka
H Pneumatikus tűzőgép
RO Capsator pneumatic
F Agrafeuse pneumatique
I Cucitrice pneumatica
E Engrapadora pneumatica
CN 气动码钉枪

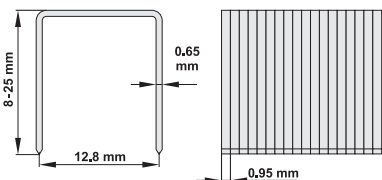

• application: industry, construction
 • przeznaczenie: przemysł, budownictwo



7 bar 8-25 mm STANDARD

BMC & COLOR SLEEVE

$L_{pA} = 74.7 \pm 2.5$ dB;
 $L_{pA} = 87.7 \pm 2.5$ dB;
 $a_h = 3.14 \pm 1.5$ m/s²

YATO	YT-0920	5
-------------	----------------	---

- GB Pneumatic nailing machine
D Druckluftnagelgerät
PL Gwoździarka pneumatyczna
RUS Пневматическая гвоздильная машина
CZ Pneumatický nástřelovač hřebíků
H Pneumatikus szögbelevő
RO Capsator pneumatic
F Cloueur pneumatique
I Chiodatrice pneumatica
E Maquina pneumática para clavar clavos
CN 气动码钉枪

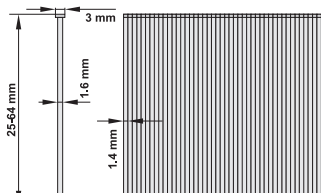

8 bar 25-64 mm 90° STANDARD

- application: industry, construction
• przeznaczenie: przemysł, budownictwo

$L_{eq} = 82,3 \pm 2,5$ dB;
 $L_{pa} = 95,3 \pm 2,5$ dB;
 $ah = 3,29 \pm 1,5$ m/s²

YATO		
YT-0921		5

BMC & COLOR SLEEVE



- GB Pneumatic nailing machine
D Druckluftnagelgerät
PL Gwoździarka pneumatyczna
RUS Пневматическая гвоздильная машина
CZ Pneumatický nástřelovač hřebíků
H Pneumatikus szögbelevő
RO Capsator pneumatic
F Cloueur pneumatique
I Chiodatrice pneumatica
E Maquina pneumática para clavar clavos
CN 气动码钉枪

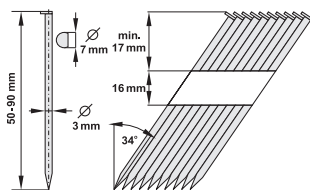

8 bar 50-90 mm 34° STANDARD

- application: industry, construction
• przeznaczenie: przemysł, budownictwo

$L_{eq} = 84,2 \pm 3,0$ dB;
 $L_{pa} = 97,2 \pm 3,0$ dB;
 $ah = 4,2 \pm 0,65$ m/s²

YATO		
YT-0923		2

BMC & COLOR SLEEVE



- GB Staples
D Heftklammern
PL Zszywki
RUS Скобы
CZ Sešívky
H Tűzőkapocs

- RO Capse tapiterie
F Agrafes
I Puntis
E Grapas
CN 码钉

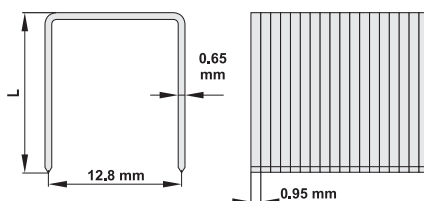

COLOR BOX

1000 PCS

for / dla: YT-0920

YATO	L (mm)	
YT-0930	8	100
YT-0931	16	50
YT-0932	25	50

- GB Nails
D Nägel
PL Gwoździe
RUS Гвозди
CZ Hřebíky
H Szeg

- RO Cuie
F Clous
I Chiodi
E Clavos
CN 直钉

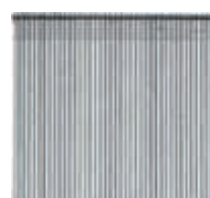
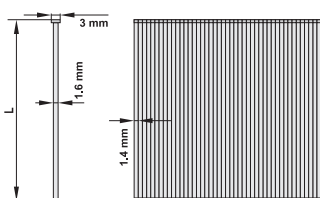

COLOR BOX

1000 PCS 90°

for / dla: YT-0921

YATO	L (mm)	
YT-0941	50	20
YT-0942	64	20

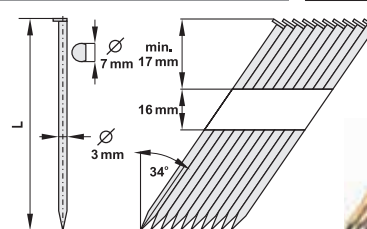
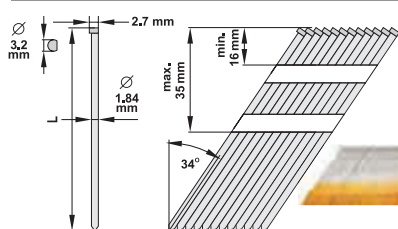

for / dla: YT-0922

1000 PCS 34°

YATO	L (mm)	
YT-0938	38	20
YT-0939	50	20
YT-0940	64	20

for / dla: YT-0923, YT-0927

500 PCS 34°

YATO	L (mm)	
YT-0935	50	10
YT-0936	75	10
YT-0937	90	10

GB Foam gun
D Fartspritzpistole
PL Pistolet do pianki montażowej
RUS Пистолет для нанесения полиуретановой пены

CZ Pistole na montážní pěnu
H Felrakó pisztoly, poliurethán habhoz
RO Pistol pt. spumă
F Pistolet mousse expansive

I Pistola per schiuma poliuretanică
E Pistola para espuma de montaje de metalo
CN 发泡枪

COLOR BOX



PTFE
 COATED
 POWLOKA



YATO **YT-6740** 10/20



YATO **YT-6741** 10/20



YATO **YT-6742** 10/20



YATO **YT-6743** 20



YATO **YT-6744** 20



YATO **YT-6745** 20

GB Caulking gun
D Kartuschenpistole
PL Wyciskacz do mas
RUS Пистолет для герметика
CZ Protlačovač na hmoty
H Masszakinyomó

RO Pistol silicon
F Pistolet à feutrer
I Pistola per silicone
E Pistola para masilla
CN 堵缝枪

300 ml



225 mm

YATO **YT-6751** L (mm) 225 10/20



225 mm

YATO **YT-6752** L (mm) 225 10/20



225 mm

YATO **YT-6753** L (mm) 225 6/12



225 mm

YATO **YT-6754** L (mm) 225 10/20



225 mm

YATO **YT-6750** L (mm) 225 20/40



225 mm

YATO **YT-6755** L (mm) 225 10/20



216 mm 60 mm

YATO **YT-6756** L (mm) 215 6/12



200 mm 65 mm

YATO **YT-6757** L (mm) 200 10/20

- GB Gas torch
D Gasbrenner
PL Palnik gazowy
RUS Газовая паяльная лампа
CZ Plynový hořák
H Gázégő
- RO Arzător de gaz
F Bruleur à gaz
I Saldatore bruciatore a gas
E Soplete de gas
CN 火焰枪



PIEZO	30 ml	60-90 min	GAS GAZ
LOCK BLOKADA	BUTANE lighter gas BUTAN (gas do zapalniczki)	CHILD PROTECTION ZABEZPECZENIE PRZED DZIECIAMI	

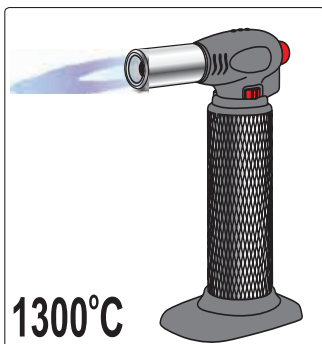

1300°C

DOUBLE BLISTER

YATO	YT-36700	10/20
------	----------	-------

- GB Soldering tool set
D Gaslötkolben satz
PL Lutownica gazowa z akcesoriami
RUS Газовый паяльный набор
CZ Plynova pajka souprava
H Gaz forrasztópaka készletek
RO Set ciocan de lipit cu gaz
F Fer à souder à gaz
I Saldatore a gas
E Soldador a gas con accesorios
CN 自动点火多功能瓦斯组套

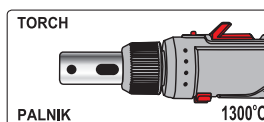
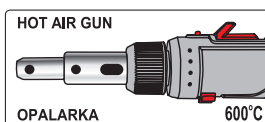
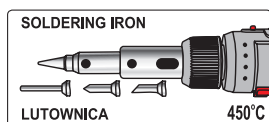

7 PCS	30-125 W	30 ml	75 min
GAS GAZ	PIEZO	LOCK BLOKADA	BUTANE lighter gas BUTAN (gas do zapalniczki)
PROPANE-BUTANE lighter gas PROPAN-BUTAN (gas do zapalniczki)	CHILD PROTECTION ZABEZPECZENIE PRZED DZIECIAMI		

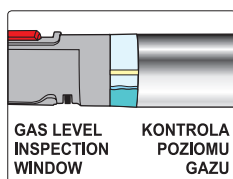

GAS LEVEL INSPECTION WINDOW
KONTROLA POZIOMU GAZU

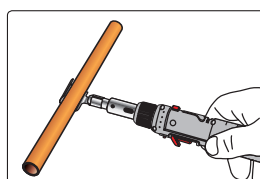

PLASTIC BOX & HANGING COLOR BOX

YATO	YT-36706	W 30-125	6
------	----------	----------	---

- GB Soldering tool 3 in 1
D Gaslötkolben 3 in 1
PL Lutownica gazowa 3 w 1
RUS Газовый паяльник 3-в-1
CZ Plynova pajka 3 in 1
H Gaz-forrasztópaka 3 in 1
RO Ciocan de lipit cu gaz 3 in 1
F Fer à souder à gaz
I Saldatore a gas
E Soldador de gas 3 in 1
CN 瓦斯焊接工具



PIEZO	30~70 W	12 ml	60 min	GAS GAZ
LOCK BLOKADA	BUTANE lighter gas BUTAN (gas do zapalniczki)	PROPANE-BUTANE lighter gas PROPAN-BUTAN (gas do zapalniczki)	CHILD PROTECTION ZABEZPECZENIE PRZED DZIECIAMI	

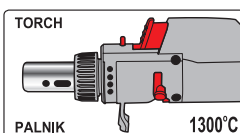
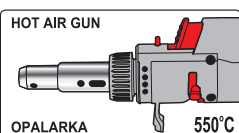
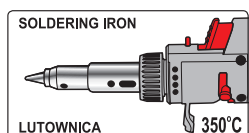

GAS LEVEL INSPECTION WINDOW
KONTROLA POZIOMU GAZU

SLIDING CARD

YATO	YT-36704	W 30-70	12/72
------	----------	---------	-------

- GB Gas blow torch
D Lötbrenner
PL Palnik gazowy
RUS Газовая горелка
- CZ Plynový hořák
H Gázégő
- RO Arzător de gaz
F Bruleur à gaz
- I Saldatore bruciatore a gas
E Soplete de gas
CN 火焰枪

PIEZO	1.28 kW	GAS GAZ	AIR POWIETRZE	LOCK BLOKADA	BUTANE BUTAN
-------	---------	---------	---------------	--------------	--------------

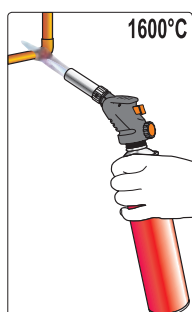

1600°C

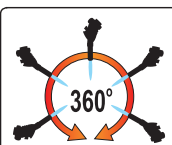

EURO TYPE EN417



SLIDING CARD

YATO	YT-36709	kW 1.28	6/12
------	----------	---------	------

- GB** Soldering iron
D Lötkolben
PL Lutownica oporowa
RUS Электропаяльник
CZ Pájka odporová
H Forrasztópáka
RO Ciocan de lipit
F Fer à souder
I Saldatore a stagno
E Soldador de resistencia
CN 电烙铁

HANGING DISPLAY COLOR BOX

230V~50Hz 400-520 °C 2-3 min



YATO	W	max. temperature of soldering tip / max. temperatura grotu (°C)	dimensions of soldering tip / wymiary grotu (mm)	
YT-8271	30	400	ø3.8 x 70	16
YT-8272	60	500	ø6.0 x 78	16
YT-8273	80	520	ø6.8 x 64	16

- GB** Desoldering pump
D Entlötsaugpumpe
PL Odsysacz do suyu
RUS Шприц для удаления припоя
CZ Odprájecí sací pumpa
H Ónszipantó
RO Pompa fluor
F Pompe à étain
I Pompa aspira stagno
E Bomba desoldadora
CN 全铝手动吸锡器

SLIDING CARD

PTFE TIP



YATO	
YT-82742	100/400



YATO	
YT-82743	100/200



YATO	
YT-82744	50/100

- GB** Transformer soldering gun
D Lötpestole
PL Lutownica transformatorowa
RUS Паяльник электрический
CZ Transformátorová páječka
H Forrasztópáka
RO Aparat de lipit letcon cu transformator
F Fer à souder
I Saldatore istantaneo
E Soldador transformador
CN 电烙铁

230V~50Hz 200 W

LED

351-500°C 201-350°C 70-200°C

- GB** Transformer soldering gun
D Lötpestole
PL Lutownica transformatorowa
RUS Паяльник электрический
CZ Transformátorová páječka
H Forrasztópáka
RO Aparat de lipit letcon cu transformator
F Fer à souder
I Saldatore istantaneo
E Soldador transformador
CN 电烙铁

230V~50Hz 180 W WORKING MODE TRYB PRACY S2 20%

LED



WORK LIGHT OŚWIETLENIE PRACY

BMC & COLOR SLEEVE

YATO	W	
YT-8245	180	10



WORK LIGHT OŚWIETLENIE PRACY

BMC & COLOR SLEEVE

YATO	W	
YT-82451	200	10

- GB** Soldering station
D Lötstation
PL Stacja lutownicza
RUS Паяльная станция
CZ Letovací stanice
H Forrasztópáka állomás
RO Stație de lipit
F Station de soudage
I Stazione digitale di saldatura
E Estación de soldadura
CN 数显焊台

230V~50Hz 48 W 150-450 °C

7.1 mm 65 mm LCD DISPLAY WSWSIELACZ

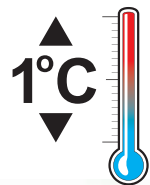

COLOR BOX

YATO	W	
YT-82455	48	4

GB Electric glue gun
D Heissklebepistole
PL Pistolet do klejenia
RUS Пистолет для клея
CZ Pistole na lepení
H Ragasztópisztoly

RO Pistol pt. lipit
F Pistolet à colle
I Pistola colla
E Pistola de cola
CN 热胶枪

230V~ 50Hz	35 (400) W	150-200 °C	15 g/min
3-6 min	∅ 11 mm		

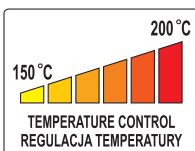

COLOR BOX

YATO	W	diameter of glue stick średnica wkładu (mm)	capacity wydajność (g/min)	
YT-82401	35 (400)	11	15	12/24

GB Electric glue gun
D Heissklebepistole
PL Pistolet do klejenia
RUS Пистолет для клея
CZ Pistole na lepení
H Ragasztópisztoly

RO Pistol pt. lipit
F Pistolet à colle
I Pistola colla
E Pistola de cola
CN 热胶枪

230V~ 50Hz	20 (80) W	180-200 °C	15 g/min
3-5 min	∅ 11 mm		



DOUBLE BLISTER

YATO	W	diameter of glue stick średnica wkładu (mm)	capacity wydajność (g/min)	
YT-82402	20 (80)	11	15	12/48

GB Glue sticks
D Heissklebepatronen
PL Wkłady klejowe
RUS Стержин для горячей склейки

CZ Lepicí vložky
H Ragasztóbetét
RO Mine cu clei
F Des bâtons de colle

I Stick di colla
E Cartucho de cola
CN 透明热熔胶棒

POLYBAG



1kg

WORKING TEMPERATURE TEMPERATURA PRACY 170-200°C	SOFTENING POINT TEMPERATURA MIEKNIENIA 85+/-2°C	OPEN TIME CZAS OTWARTY 20-30 s	TRANSPARENT BEZBARWNE
---	---	--------------------------------------	--------------------------



∅11mm
200mm

YATO	size / rozmiar (mm)	
YT-82430	∅11 / 200	120



∅11mm
300mm

YATO	size / rozmiar (mm)	
YT-82431	∅11 / 300	20

GB Glue sticks
D Heissklebepatronen
PL Wkłady klejowe
RUS Стержин для горячей склейки
CZ Lepicí vložky
H Ragasztóbetét
RO Mine cu clei
F Des bâtons de colle
I Stick di colla
E Cartucho de cola
CN 色热熔胶棒



5 PCS	∅11mm 200mm	WORKING TEMPERATURE TEMPERATURA PRACY 170-200°C	SOFTENING POINT TEMPERATURA MIEKNIENIA 85+/-2°C	OPEN TIME CZAS OTWARTY 20-30 s
----------	----------------	---	---	--------------------------------------

COLOR BOX WITH WINDOW

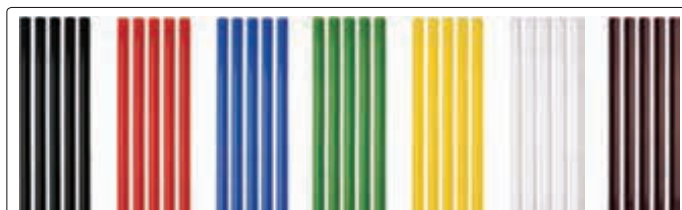

YATO	color / kolor	size / rozmiar (mm)	
YT-82433	●	∅11 / 200	40/120
YT-82434	●	∅11 / 200	40/120
YT-82435	●	∅11 / 200	40/120
YT-82436	●	∅11 / 200	40/120
YT-82437	●	∅11 / 200	40/120
YT-82438	○	∅11 / 200	40/120
YT-82439	●	∅11 / 200	40/120

13

Construction tools Narzędzia budowlane



Floor laminate cutters
Gilotyny do cięcia paneli podłogowych

224



Roofwork tools
Narzędzia dekarские

233-234



Tile cutting machines & accessories
Przyrządy do cięcia glazury i akcesoria

224-225



Floating rules
Łaty

234



Profile gauges
Wzorniki profili

226



Knives
Noże

234-235



Scrapers
Szpachelki

226



Electric hoists
Elektryczne wciągarki linowe

235



Masonry tools
Narzędzia tynkarskie i murarskie

227-228



Extension cords
Przedłużacze elektryczne

236



Floats
Pace..... 227
Trowels
Kielnie..... 228
Plaster scrubbers
Zdzieraki do tynków..... 228

Mixers
Mieszadła

237



Tools for drywalls
Narzędzia do płyt gipsowo-kartonowych

229



Pencils
Ołówki

238



Shears
Nożyce

230-233



Carpenter's pencils
Ołówki stolarskie..... 238
Masonry pencils
Ołówki murarskie..... 238

- GB** Floor laminate cutter
- D** Laminat-Schneider
- PL** Gilotyina do cięcia paneli podłogowych
- RUS** Гильотина для ламината
- CZ** Nůžky na laminátové plovoucí podlahy
- H** Laminált padló vágógép
- RO** Aparat de taiat parchet laminat
- F** Guillotine pour couper les panneaux
- I** Ghigliottina per taglio dei pannelli
- E** Guillotina cortapaneles
- CN** 木地板切割器

12 mm max. CUTTING THICKNESS GRUBOSCIECIECA
210 mm max. CUTTING LENGTH DRUGOSCIECIECA
ZINC PLATED CYNKOWANA

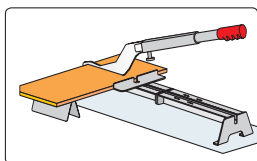
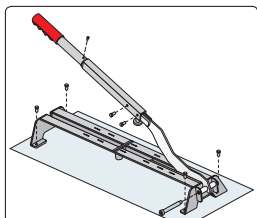

FOLDABLE
SKŁADANA



YATO		
YT-3701		2

- GB** Tile cutting machine
- D** Fliesenschneidmaschine
- PL** Przyrząd do cięcia glazury
- RUS** Плиткорез
- CZ** Přístroj na řezání glazury
- H** Csempevágó
- RO** Instrument de tăiere a glazurei
- F** Coupeuse pour la céramique
- I** Ghigliottina per taglio di piastrelle
- E** Cortadora de gres
- CN** 瓷砖切割轮

CUTTING CIECIE ±45°
14 mm max. CUTTING THICKNESS GRUBOSCIECIECA
22x6x2 mm
YG6X TUNGSTEN CARBIDE TP CUTTING & WHEELSŁAKA WOLFRAMU
COATED TiN POWŁOKA



YATO	L (mm)	
YT-3701	600	2

- GB** Tile cutting machine
- D** Fliesenschneidmaschine
- PL** Przyrząd do cięcia glazury
- RUS** Плиткорез
- CZ** Přístroj na řezání glazury
- H** Csempevágó
- RO** Instrument de tăiere a glazurei
- F** Coupeuse pour la céramique
- I** Ghigliottina per taglio di piastrelle
- E** Cortadora de gres
- CN** 瓷砖切割轮

CUTTING CIECIE 0-45°
14 mm max. CUTTING THICKNESS GRUBOSCIECIECA
12,6x3x3 mm
YG6X TUNGSTEN CARBIDE TP CUTTING & WHEELSŁAKA WOLFRAMU
COATED TiN POWŁOKA



YATO	L (mm)	
YT-3703	630	2

- GB** Tile cutting wheel
- D** Schneidrad
- PL** Kółko tnące wymienne
- RUS** Ролик для плиткореза
- CZ** Výměnné kolečko
- H** Cserélgörgő csavarral
- RO** Cuțit rolă
- F** Molette coupante avec barre
- I** Lama di ricambio tondo
- E** Recambio de cuchillo redondo
- CN** 硬质合金刀片

SLIDING CARD

YG6X TUNGSTEN CARBIDE TP CUTTING & WHEELSŁAKA WOLFRAMU
COATED TiN POWŁOKA



for / dla: YT-3700, YT-3701, YT-3702



for / dla: YT-3703



YATO			YATO		
YT-3712		50/250	YT-3713		50/200

- GB** Tile cutting machine
D Fliesenschneidmaschine
PL Przyrząd do cięcia glazury
RUS Плиткопес
CZ Přístroj na řezání glazury
H Csempévágó
RO Instrument de tăiere a glazurei
F Coupeuse pour la céramique

- I** Ghigliottina per taglio di piastrelle
E Cortadora de gres
CN 瓷磚切割輪



CUTTING
CIĘCIE
0-45°

20
mm
Ø



22x14x2.8
mm

YG6X
TRIMMER CARBIDE TP
OSTRZE Z WĘGLIKA
WOLFRAMU

COATED
TiN
POWŁOKA

COLOR BOX



YATO 	L (mm)	
YT-3704	600	1
YT-3705	900	1

- GB** Tile cutting machine
D Fliesenschneidmaschine
PL Przyrząd do cięcia glazury
RUS Плиткопес
CZ Přístroj na řezání glazury
H Csempévágó

- RO** Instrument de tăiere a glazurei
F Coupeuse pour la céramique
I Ghigliottina per taglio di piastrelle
E Cortadora de gres
CN 瓷磚切割輪



CUTTING
CIĘCIE
0-45°

16
mm
Ø



22x14x2.0
mm

YG6X
TRIMMER CARBIDE TP
OSTRZE Z WĘGLIKA
WOLFRAMU

COATED
TiN
POWŁOKA

COLOR BOX



YATO 	L (mm)	
YT-3706	500	2
YT-3707	600	2
YT-3708	800	2

- GB** Tile cutting wheel
D Schneidrad
PL Kółko tnące wymienne

- RUS** Ролик для плиткопеса
CZ Výměnné kolečko
H Cseregörgő csavarral

- RO** Cuțit rolă
F Molette coupante avec barre
I Lama di ricambio tondo

- E** Recambio de cuchillo redondo
CN 硬質合金刀片

SLIDING CARD



YG6X
TRIMMER CARBIDE TP
OSTRZE Z WĘGLIKA
WOLFRAMU

COATED
TiN
POWŁOKA



 22x11x2.0 mm for / dla: YT-3704, YT-3705, YT-3706, YT-3707, YT-3708

 22x14x2.0 mm for / dla: YT-3704, YT-3705, YT-3706, YT-3707, YT-3708

YATO 	
YT-3714	50/200

YATO 	
YT-37141	50/200

- GB** Tile cutting pliers
D Glasurzange
PL Szczypce do cięcia i lamania glazury
RUS Кусачки для плитки
CZ Kleště do glazury
H Csempéfógó

- RO** Cleste rupt faianta
F Pince grès mosaïque
I Tenaglia per piastrelle
E Tenazas para azulejos
CN 瓷磚鉗

200
mm

YG-6X



SLIDING CARD



YATO 	L (mm)	
YT-37160	200	6/36

- GB** Tile cutting pliers
D Glasurzange
PL Szczypce do lamania glazury
RUS Кусачки для плитки
CZ Kleště do glazury
H Csempéfógó

- RO** Cleste rupt faianta
F Pince grès mosaïque
I Tenaglia per piastrelle
E Tenazas para azulejos
CN 瓷磚鉗

200
mm

2x  **YG-6X**

COATED
TiN
POWŁOKA



SLIDING CARD



YATO 	L (mm)	
YT-37161	200	6/36

- GB** Tile cutting pliers
D Glasurzange
PL Szczypce do glazury
RUS Кусачки для плитки
CZ Kleště do glazury
H Csempéfógó
RO Cleste rupt faianta
F Pince grès mosaïque
I Tenaglia per piastrelle
E Tenazas para azulejos
CN 瓷磚鉗



SLIDING CARD



YATO 	L (mm)	
YT-37164	200	6/60

- GB** Grout remover
D Fugenreiniger
PL Skrobak do fug
RUS Скребок для швов кладки
CZ Škrábák na spáry
H Fugakihúzó

- RO** Răzuitoare pt. rosturi
F Gratteur pour fugues
I Raschietto per fuga piastrelle
E Rascador para juntas
CN 砂浆去除器

200
mm

YG6X
TRIMMER CARBIDE TP
OSTRZE Z WĘGLIKA
WOLFRAMU



SLIDING CARD



YATO 	
YT-37170	10/60

GB Profile gauge
D Profilmuster
PL Wzornik profili

RUS Шаблон профилей
CZ Profilová šablona
H Profilsablon

RO Șablon profile
F Jauges d'épaisseurs métriques

I Profilato
E Plantilla de perfiles
CN 轮廓仪

SLIDING CARD



44 mm

1.5 mm



YATO	L (mm)	
YT-3735	125	24/72

YATO	L (mm)	
YT-3736	260	10/40

GB Trowel for silicone
D Spachtel für Silikon
PL Szpachelka do silikonu

RUS Шпатель для силикона
CZ Špachtle na silikon
H Spachli szilikonhoz

RO Spatulă pt. silicon
F Spatule à silicone
I Spatola per silicone

E Espátula para silicona
CN 橡塑刮板

TPR



4 PCS



4 PCS



YATO	
YT-5260	20/300

YATO	
YT-5261	20/200

YATO	
YT-5262	20/200

GB Silicone scraper tool kit
D Schabern zu Silikonfugen satz
PL Zestaw skrobaków do fug silikonowych
RUS Набор скребками для суставов силиконовые
CZ Sada škrabky na silikonových spár
H Készlet-ből kaparók szilikon izületek

RO Set de raclete silicon articulațiilor
F Jeu de grattoirs a joints en silicone
I Set di raschiatori per fughe in silicone
E Conjunto de rascadores a las juntas de silicona
CN 件套塑料美缝器组套

SLIDING CARD



ABS

13



2 PCS



3 PCS

YATO	
YT-52630	10/60

YATO	
YT-52631	10/60

GB Caulking tool set
D Fugenglätter set
PL Zestaw narzędzi do fug silikonowych
RUS Набор инструментов уплотнительных
CZ Sada nástrojů pro spoje
H Az izületek eszközeik
RO Un set de instrumente pt. rosturi
F Un ensemble d'outils pour les articulations
I Set di attrezzi per fughe in silicone
E Un conjunto de herramientas para empalmes
CN 件套钢丝刷组套



4 PCS

TPR

SLIDING CARD





YATO	
YT-52621	12/48

- GB** Smooth float
D Schweizer Glättkelle
PL Paca gładka
RUS Тёрка гладкая
CZ Hladitko rovné
H Glettvás rozsdamentes
- RO** Gletiera
F Truelle inoxydable
I Frattazzo liscio
E Llana para enlucido
CN 不锈钢砌墙刀

STAINLESS
STEEL
STAL
NIERDZEWNA



• made of special cold rolled stainless steel sheet with elasticity factor up to 2000 N/mm
• części robocze ze specjalnej zimnowalcowanej blachy nierdzewnej o sprężystości do 2000 N/mm



YATO 	mm	
YT-5200	270x130	30

- GB** Float with teeth
D Zahnkelle
PL Paca zębata
RUS Тёрка с зубами
CZ Hladitko zuby
H Glettvás fogazott
- RO** Gletiera zimtata
F Truelle inoxydable
I Frattazzo dentato
E Llana dentada
CN 不锈钢砌墙刀

STAINLESS
STEEL
STAL
NIERDZEWNA



• made of special cold rolled stainless steel sheet with elasticity factor up to 2000 N/mm
• części robocze ze specjalnej zimnowalcowanej blachy nierdzewnej o sprężystości do 2000 N/mm



YATO 	teeth / zęby	mm	
YT-5202	6x6	275x130	30
YT-5203	8x8	270x130	30
YT-5204	10x10	260x130	30

- GB** Smooth float
D Schweizer Glättkelle
PL Paca tynkarska
RUS Тёрка гладкая
CZ Hladitko rovné
H Glettvás rozsdamentes
- RO** Gletiera
F Truelle inoxydable
I Frattazzo
E Llana para enlucido
CN 不锈钢砌墙刀

STAINLESS
STEEL
STAL
NIERDZEWNA



• made of special cold rolled stainless steel sheet with elasticity factor up to 2000 N/mm
• części robocze ze specjalnej zimnowalcowanej blachy nierdzewnej o sprężystości do 2000 N/mm

YATO 	mm	
YT-5207	380x130	10
YT-5209	480x130	10
YT-5210	580x130	10

- GB** Sharp ground float
D Steinholzglätter
PL Paca ostra
RUS Стальная острая тёрка
CZ Hladitko ocelové, špičaté
H Aljzatsimitó
- RO** Gletiera cu varf ascuțit
F Truelle acier
I Frattazzo acuto
E Llana pontiaguda
CN 不锈钢砌墙刀





YATO 	mm	
YT-5212	500	20

- GB** Smooth float
D Glättkelle
PL Paca wenecka
RUS Тёрка венецианская
CZ Hladitko rovné
H Glettvás rozsdamentes lágy fogantyúval
- RO** Gletiera
F Truelle acier
I Frattazzo
E Llana puntas redondas
CN 不锈钢砌墙刀

STAINLESS
STEEL
STAL
NIERDZEWNA





• made of special cold rolled stainless steel sheet with elasticity factor up to 2000 N/mm
• części robocze ze specjalnej zimnowalcowanej blachy nierdzewnej o sprężystości do 2000 N/mm

YATO 	mm	
YT-5214	200x80	20

- GB** Abrasive float "Rasp" type
D Styropor-Schleifbrett
PL Paca ścierna do styropianu
RUS Шлифовальная тёрка "рашпиль"
CZ Škrábák na porobeton
H Csizsoló polystirol habhoz
RO Gletiera abraziva
F Flotteur abrasif à styrofoam
- I** Frattazzo abrasivo
E Llana abrasiva para polietileno
CN 磨砂型砌墙刀



YATO 	mm	
YT-5218	165x370	20



- GB Stripping knife
- D Flächenspachtel
- PL Szpachla fasadowa
- RUS Стальной шпатель
- CZ Stěrka fasádní
- H Spatulya fali (rákli)
- RO Spaclu inox
- F Spatule inoxydable
- I Spatola per facciata
- E Espátula de fachada
- CN 剥皮刀



STAINLESS
STEEL
STAL
NERDZEWNIA

AI

• made of special cold rolled stainless steel sheet with elasticity factor up to 2000 N/mm
• części robocze ze specjalnej zimnowalcowanej blachy nierdzewnej o sprężystości do 2000 N/mm

YATO 	mm	
YT-5226	250	20
YT-5228	350	20
YT-5230	500	20

- GB Triangular trowel
- D Mauerkelle
- PL Kielnia trójkątna
- RUS Треугольный мастерок
- CZ Lžíce trojúhelníková
- H Kőműves kanál háromszögletű
- RO Mistrie triunghi
- F Truelle
- I Cazzuola punta triangolare
- E Paleta triangular
- CN 不锈钢砌墙刀



STAINLESS
STEEL
STAL
NERDZEWNIA

• made of special cold rolled stainless steel sheet with elasticity factor up to 2000 N/mm
• części robocze ze specjalnej zimnowalcowanej blachy nierdzewnej o sprężystości do 2000 N/mm

YATO 	mm	
YT-5234	200x190	10

- GB Trapezoid trowel
- D Stukkateurkelle
- PL Kielnia trapezowa
- RUS Трапецидальный мастерок
- CZ Lžíce zednická
- H Kőműves kanál rozsdamentes
- RO Mistrie
- F Truelle trapézoïdale
- I Cazzuola punta trapezio
- E Paleta trapezoidal
- CN 不锈钢砌墙刀



STAINLESS
STEEL
STAL
NERDZEWNIA

• made of special cold rolled stainless steel sheet with elasticity factor up to 2000 N/mm
• części robocze ze specjalnej zimnowalcowanej blachy nierdzewnej o sprężystości do 2000 N/mm

YATO 	mm	
YT-5237	120x180x80	10

- GB Trapezoid trowel
- D Stukkateurkelle
- PL Kielnia trapezowa
- RUS Трапецидальный мастерок
- CZ Lžíce zednická
- H Kőműves kanál rozsdamentes
- RO Mistrie
- F Truelle trapézoïdale
- I Cazzuola punta trapezio
- E Paleta trapezoidal
- CN 不锈钢砌墙刀



STAINLESS
STEEL
STAL
NERDZEWNIA

• made of special cold rolled stainless steel sheet with elasticity factor up to 2000 N/mm
• części robocze ze specjalnej zimnowalcowanej blachy nierdzewnej o sprężystości do 2000 N/mm



YATO 	mm	
YT-5240	165x80x55	20

- GB Stucco trowel
- D Gipserspachtel
- PL Kielnia „Podkowa”
- RUS Штукатурный мастерок
- CZ Lžíce vymazávací
- H Gittelő kanál rozsdamentes
- RO Mistrie
- F Truelle en stuc
- I Cazzuola punta tonda
- E Paleta para estucado
- CN 不锈钢砌墙刀



STAINLESS
STEEL
STAL
NERDZEWNIA

• made of special cold rolled stainless steel sheet with elasticity factor up to 2000 N/mm
• części robocze ze specjalnej zimnowalcowanej blachy nierdzewnej o sprężystości do 2000 N/mm

YATO 	mm	
YT-5242	100x130	20
YT-5243	80x110	20

- GB Stucco sharp trowel
- D Putzkelle
- PL Kielnia ostra
- RUS Кельма заостренная треугольная
- CZ Lžíce pokývačská
- H Gittelő kanál rozsdamentes
- RO Mistrie cu cioc ascutit
- F Truelle
- I Cazzuola punta acuta
- E Paleta pontiaguda
- CN 不锈钢砌墙刀

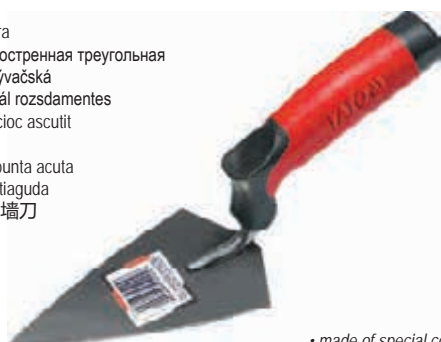

STAINLESS
STEEL
STAL
NERDZEWNIA

• made of special cold rolled stainless steel sheet with elasticity factor up to 2000 N/mm
• części robocze ze specjalnej zimnowalcowanej blachy nierdzewnej o sprężystości do 2000 N/mm

YATO 	mm	
YT-5245	135x80	20

- GB Plaster scrubber
- D Alu-Rabott
- PL Zdzierak do tynków
- RUS Треугольный мастерок для каменщиков
- CZ Škrabák
- H Vakolat gyalu alu késcs
- RO Gletiera abraziva
- F Enleveur du badigeon
- I Utensile per sgrossare
- E Rascador para enlucido
- CN 石膏去除器



AI

YATO 	mm	
YT-5247	450x90	25

- GB** Wallboard carrier
D Plattenträger mit Tragegriff
PL Uchwyt do noszenia płyt gipsowo-kartonowych
RUS Приспособление для переноски плит
CZ Držák pro přenášení desek s rukojetí
H Jellemzők és előnyök
RO Dispositiv pt. transportat plac de gips-carton
F Porte-plaques a griffes
I Impugnatura porta lastre in cartongesso
E Empunadura porta-placas
CN 石膏板提取器

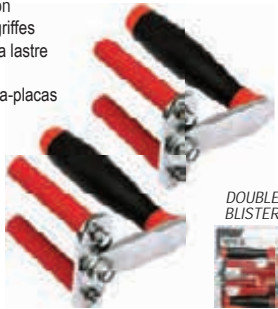
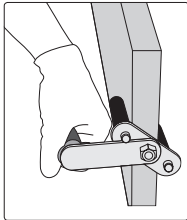

- GB** Panel carry
D Plattenträger mit Tragegriff
PL Nosidło do płyt gipsowo-kartonowych
RUS Приспособление для переноски плит
CZ Držák pro přenášení desek s rukojetí
H Gipskarton hordó
RO Dispositiv pt. transportat plac de gips-carton
F Poignée transport de plaque
I Porta lastre in cartongesso
E Porta-paneles
CN 石膏板提手



80 kg (max)
ABS

- GB** Drywall board lifter
D Hebel zu platten fortragen
PL Aluminiowa dźwignia do unoszenia płyt gipsowo-kartonowych
RUS Приспособление для поднятия листов гипсокартона и отделочных панелей
CZ Páka pre zdvíhacie plošiny
H Gipskarton emelő
RO Elevator de picior
F Levier a panneau
I Sollevatore in alluminio per lastre
E Levanta paneles
CN 石膏板起板器

COLOR BOX



55 mm LIFTING CAPACITY
WYSOKOŚĆ UDZIGNIĘCIA
AI



YATO
YT-37440 2/12

YATO max. lifting capacity / max. udźwig (kg)
YT-37444 80 12

YATO
YT-37450 10

- GB** Edge planing machine for gypsum plate
D Gipskartonhobel
PL Strug do krawędzi płyt gipsowo-kartonowych
RUS Рубанок кромоочный для гипскартона
CZ Sadrokarton hoblak
H Étgyalu gipszkartonhoz
RO Dispozitiv slefuit, sanfreant gips carton
F Placoplâtre raboteuse
I Piaalla per bordi per lastre in cartongesso
E Cepillo biselador carton yeso
CN 塑料刨边器

9.5-15 mm

2 BLADES
OSTRZA



COLOR BOX

YATO
YT-76260 10/60

- GB** Telescopic support bar
D Baustütze-Schnellspannstütze
PL Podpora teleskopowa
RUS Подъемник-распорка для гипскартона
CZ Tyč teleskopická rozpěrná
H Teleszkópos támasztórúd
RO Suport sustinere telescopic
F Presse extensible
I Supporto telescopico
E Puntal expansion
CN 伸缩顶杆



115 cm
60 cm

YATO
YT-64551 6



290 cm
125 cm

YATO
YT-64552 6

30kg max.

POLYBAG

- GB** Pliers for hollow expansion bolts
D Maueranker-Einsetzwerkzeug Satz
PL Zaciskarka do kołków „Molly”
RUS Клещи для дюбелей „Молли”
CZ Kotvící kleště
H Kreater üreges fémdübel

- RO** Set cleste dibluri
F Pince pour chevilles creux
I Crimpatrice per pioli „Molly”
E Alicates para tacos „Molly”
CN 膨胀螺栓钳组套

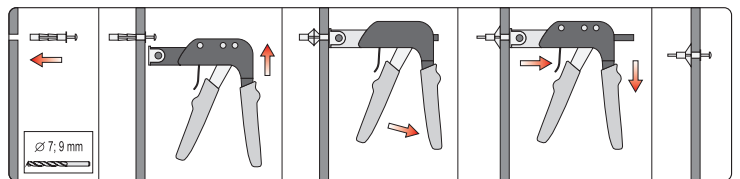

- 5x \varnothing 7 mm (32 mm)
5x \varnothing 9 mm (37 mm)
 \varnothing 4 mm (40 mm)
 \varnothing 5 mm (44 mm)



- 35x \varnothing 7 mm (32 mm)
10x \varnothing 9 mm (52 mm)
15x \varnothing 9 mm (37 mm)
 \varnothing 4 mm (40 mm)
 \varnothing 5 mm (58 mm)
 \varnothing 5 mm (44 mm)

DOUBLE BLISTER

60 pcs



PLASTIC BOX

YATO
YT-51450 6/24

YATO
YT-51451 3/12

GB Tin snips
D Blechscher
PL Nożyce do cięcia blachy

RUS Ножницы по металлу
CZ Nůžky na plech
H Lemezvágó olló

RO Foarfece pt. tablă
F Cisaille à tôle
I Cesoie per lamiera

E Tijeras para chapas
CN 铁皮剪

SLIDING CARD



LEFT CUT
CIECIE
LEWE

CrMo

INCREASED CUTTING POWER
ZWIĘKSZONA SIŁA CIĘCIA



HRC 60-62

DIN 6438

YATO	L (mm)	cutting length (mm)	cutting capacities (mm)				6/36
			copper	cold-rolled steel	hard steel HRC35	stainless steel 304	
YT-1910	260	35	1.80	1.50	1.00	0.90	6/36



HRC 60-62

DIN 6438

YATO	L (mm)	cutting length (mm)	cutting capacities (mm)				6/36
			copper	cold-rolled steel	hard steel HRC35	stainless steel 304	
YT-1915	235	30	1.50	1.20	1.00	0.70	6/36



HRC 60-62

DIN 6438

YATO	L (mm)	cutting length (mm)	cutting capacities (mm)				6/36
			copper	cold-rolled steel	hard steel HRC35	stainless steel 304	
YT-1918	260	32	1.80	1.50	1.00	0.90	6/36



HRC 56-62

SERRATED EDGES
ZĄBKOWANA KRAWĘDZ
OSTRZY

HIGH FREQUENCY HARDENING
HARTOWANIE IMPULSOWE

YATO	L (mm)	cutting length (mm)	cutting capacities (mm)				6/36
			copper	cold-rolled steel	hard steel HRC35	stainless steel 304	
YT-1916	250	40	2.00	1.50	1.00	0.80	6/36

GB Tin snips
D Blechscher
PL Nożyce do cięcia blachy
RUS Ножницы по металлу
CZ Nůžky na plech
H Lemezvágó olló
RO Foarfece pt. tablă
F Cisaille à tôle
I Cesoie per lamiera
E Tijeras para chapas
CN 铁皮剪



LEFT CUT
CIECIE
LEWE

HRC 60-62

CrMo

90°

SERRATED EDGES
ZĄBKOWANA KRAWĘDZ
OSTRZY

SLIDING CARD



YATO	L (mm)	cutting length (mm)	cutting capacities (mm)				6/36
			copper	cold-rolled steel	hard steel HRC35	stainless steel 304	
YT-1913	225	30	0.78	0.53	0.46	0.36	6/36

GB Tin snips
D Blechscher
PL Nożyce do cięcia blachy

RUS Ножницы по металлу
CZ Nůžky na plech
H Lemezvágó olló

RO Foarfece pt. tablă
F Cisaille à tôle
I Cesoie per lamiera

E Tijeras para chapas
CN 铁皮剪

SLIDING CARD



STRAIGHT CUT
CIECIE
PROSTE

CrMo

INCREASED CUTTING POWER
ZWIĘKSZONA SIŁA CIĘCIA



HRC 60-62

DIN 6438

YATO	L (mm)	cutting length (mm)	cutting capacities (mm)				6/36
			copper	cold-rolled steel	hard steel HRC35	stainless steel 304	
YT-1912	260	35	1.80	1.50	1.00	0.90	6/36



HRC 60-62

DIN 6438

YATO	L (mm)	cutting length (mm)	cutting capacities (mm)				6/36
			copper	cold-rolled steel	hard steel HRC35	stainless steel 304	
YT-1922	290	75	1.10	0.94	0.70	0.53	6/36



HRC 60-62

DIN 6438

YATO	L (mm)	cutting length (mm)	cutting capacities (mm)				6/36
			copper	cold-rolled steel	hard steel HRC35	stainless steel 304	
YT-1923	230	25	2.00	1.60	1.20	1.20	6/36

HRC 56-62

SERRATED EDGES
ZĄBKOWANA KRAWĘDZ
OSTRZY

HIGH FREQUENCY HARDENING
HARTOWANIE IMPULSOWE



YATO	L (mm)	cutting length (mm)	cutting capacities (mm)				6/36
			copper	cold-rolled steel	hard steel HRC35	stainless steel 304	
YT-1962	250	45	2.00	1.50	1.00	0.80	6/36

GB Tin snips
D Blechscherer
PL Nożyce do cięcia blachy

RUS Ножницы по металлу
CZ Nůžky na plech
H Lemezvágó olló

RO Foarfece pt. tablă
F Cisaille à tôle
I Cesioie per lamiere

E Tijeras para chapas
CN 铁皮剪

SLIDING
CARD



RIGHT
CUT
CIECIE
PRAWĘ

CrMo

INCREASED
CUTTING
POWER
ZWIĘKSZONA
SIŁA CIĘCIA

HRC
60-62

DIN
6438



HRC
60-62

DIN
6438



YATO	L (mm)	cutting length (mm)	cutting capacities (mm)				box
			copper	cold-rolled steel	hard steel HRC35	stainless steel 304	
YT-1911	260	35	1.80	1.50	1.00	0.90	6/36

YATO	L (mm)	cutting length (mm)	cutting capacities (mm)				box
			copper	cold-rolled steel	hard steel HRC35	stainless steel 304	
YT-1916	235	30	1.50	1.20	1.00	0.70	6/36

HRC
60-62

DIN
6438



HRC
56-62

SERRATED
EDGES
ZABKOWANA
KRAWĘDZ
OSTRZY

HIGH
FREQUENCY
HARDENING
HARTOWANIE
IMPULSOWE



YATO	L (mm)	cutting length (mm)	cutting capacities (mm)				box
			copper	cold-rolled steel	hard steel HRC35	stainless steel 304	
YT-1919	260	32	1.80	1.50	1.00	0.90	6/36

YATO	L (mm)	cutting length (mm)	cutting capacities (mm)				box
			copper	cold-rolled steel	hard steel HRC35	stainless steel 304	
YT-1961	250	40	2.00	1.50	1.00	0.80	6/36

GB Tin snips
D Blechscherer
PL Nożyce do cięcia blachy
RUS Ножницы по металлу
CZ Nůžky na plech
H Lemezvágó olló

RO Foarfece pt. tablă
F Cisaille à tôle
I Cesioie per lamiere
E Tijeras para chapas
CN 铁皮剪

RIGHT
CUT
CIECIE
PRAWĘ

HRC
60-62

CrMo

90°

SERRATED
EDGES
ZABKOWANA
KRAWĘDZ
OSTRZY



SLIDING
CARD



YATO	L (mm)	cutting length (mm)	cutting capacities (mm)				box
			copper	cold-rolled steel	hard steel HRC35	stainless steel 304	
YT-1914	225	30	0.78	0.53	0.46	0.36	6/36

GB Tin snips
D Blechscherer
PL Nożyce do cięcia blachy
RUS Ножницы по металлу

CZ Nůžky na plech
H Lemezvágó olló
RO Foarfece pt. tablă
F Cisaille à tôle

I Cesioie per lamiere
E Tijeras para chapas
CN 铁皮剪

SLIDING
CARD



LEFT
CUT
CIECIE
LEWĘ

DROP
FORGED
KUTE

HRC
58-61



YATO	L (mm)	cutting length (mm)	cutting capacities (mm)				box
			copper	cold-rolled steel	hard steel HRC35	stainless steel 304	
YT-1900	260	30	0.94	0.78	0.60	0.45	6/24

GB Tin snips
D Blechscherer
PL Nożyce do cięcia blachy
RUS Ножницы по металлу

CZ Nůžky na plech
H Lemezvágó olló
RO Foarfece pt. tablă
F Cisaille à tôle

I Cesioie per lamiere
E Tijeras para chapas
CN 铁皮剪

SLIDING
CARD



RIGHT
CUT
CIECIE
PRAWĘ

DROP
FORGED
KUTE

HRC
58-61



YATO	L (mm)	cutting length (mm)	cutting capacities (mm)				box
			copper	cold-rolled steel	hard steel HRC35	stainless steel 304	
YT-1901	260	30	0.94	0.78	0.60	0.45	6/24



YATO	L (mm)	cutting length (mm)	cutting capacities (mm)				box
			copper	cold-rolled steel	hard steel HRC35	stainless steel 304	
YT-1902	300	50	0.94	0.78	0.60	0.45	6/24

- GB Tin snips
- D Blechscherer
- PL Nożyce do cięcia blachy
- RUS Ножницы по металлу
- CZ Nůžky na plech
- H Lemezvágó olló
- RO Foarfece pt. tablă
- F Cisaille à tôle
- I Cesioie per lamiera
- E Tijeras para chapas
- CN 铁皮剪

SLIDING CARD



S55C
DROP-FORGED
STEEL
STAL KUTIA
NA ZBIWNO

HRC
55-60

HIGH
FREQUENCY
HARDENING
HARTONAME
IMPULSOWE

- GB Tin snips
- D Blechscherer
- PL Nożyce do cięcia blachy
- RUS Ножницы по металлу
- CZ Nůžky na plech
- H Lemezvágó olló

- RO Foarfece pt. tablă
- F Cisaille à tôle
- I Cesioie per lamiera
- E Tijeras para chapas
- CN 铁皮剪

SLIDING CARD



For cutting
straight and
tight curves
left or right



YATO	L (mm)	cutting length (mm)	cutting capacities (mm)				6/36
			copper	cold-rolled steel	hard steel HRC35	stainless steel 304	
YT-1970	260	42	2.0	1.4	1.0	1.0	6/36

STRAIGHT
CUT
CIĘCIE
PROSTE

HRC
58-61

DROP
FORGED
KUTE



YATO	L (mm)	cutting length (mm)	cutting capacities (mm)				6/36
			copper	cold-rolled steel	hard steel HRC35	stainless steel 304	
YT-1925	225	52	0.94	0.78	0.60	0.45	6/36



HRC
58-60

YATO	L (mm)	cutting length (mm)	cutting capacities (mm)				6/36
			copper	cold-rolled steel	hard steel HRC35	stainless steel 304	
YT-1920	260	42	1.20	1.00	0.60	0.50	6/36

- GB Tin snips
- D Blechscherer
- PL Nożyce do cięcia blachy
- RUS Ножницы по металлу
- CZ Nůžky na plech
- H Lemezvágó olló
- RO Foarfece pt. tablă
- F Cisaille à tôle
- I Cesioie per lamiera
- E Tijeras para chapas
- CN 铁皮剪

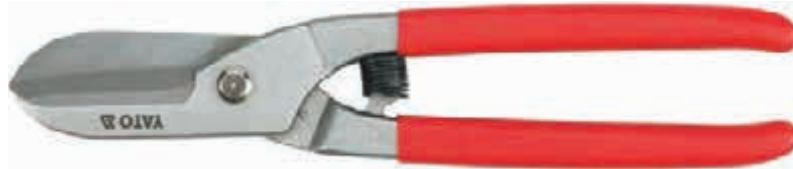

SLIDING CARD



For cutting
straight and
tight curves
left or right

HRC
58-61

YATO	L (mm)	cutting length (mm)	cutting capacities (mm)				6/36
			copper	cold-rolled steel	hard steel HRC35	stainless steel 304	
YT-1924	254	52	0.94	0.78	0.60	0.45	6/36

- GB Tin snips
- D Blechscherer
- PL Nożyce do cięcia blachy
- RUS Ножницы по металлу
- CZ Nůžky na plech
- H Lemezvágó olló
- RO Foarfece pt. tablă
- F Cisaille à tôle

- I Cesioie per lamiera
- E Tijeras para chapas
- CN 铁皮剪

SLIDING CARD



S55C
DROP-FORGED
STEEL
STAL KUTIA
NA ZBIWNO

HRC
55-60

HIGH
FREQUENCY
HARDENING
HARTONAME
IMPULSOWE



YATO	L (mm)	cutting length (mm)	cutting capacities (mm)				6/36
			copper	cold-rolled steel	hard steel HRC35	stainless steel 304	
YT-1963	200	40	1.5	1.0	0.6	0.6	6/36
YT-1964	250	60	1.8	1.2	0.8	0.8	6/24
YT-1965	300	75	2.0	1.4	0.8	0.8	6/12

- GB Metal sheet nibbler
- D Blechnibbler
- PL Nożyce matrycowe do blachy
- RUS Ножницы для резки жести
- CZ Nůžky na plech
- H Lemezvágó olló
- RO Foarfece pt. tablă
- F Grignoteuse a tole
- I Cesioia roditrice per lamiera
- E Tijeras para chapas
- CN 法式剪

HALF
DOUBLE
BLISTER



260
mm

1 mm
METAL PLATE
BLACHA

1.2 mm
ALUMINIUM
COOPER
ALUMINIUM
MEZO

2 mm
PLASTIC
PLASTIK

Mn
65

3 mm
CHANGEABLE
CUTTING
BLADES
WYMIENNE
OSTRZA



YATO	L (mm)	6/36
YT-19260	260	6/36

- GB Spare blades for metal sheet nibbler
- D Abbrechklingen für Blechnibbler
- PL Ostrza zapasowe do nożyc matrycowych
- RUS Лезвия для ножиц для резки жести
- CZ Ostří náhradní
- H Tartalékpenge

- RO Lame de rezervă
- F Lame sécables pour grignoteuse a tole
- I Lame di ricambio per cesioia roditrice per lamiera
- E Cuchillas de recambio
- CN 法式剪备用刀片

3
PCS

Mn
65



for / dla:
YT-19260

YATO	10/100
YT-19261	10/100

SKIN
CARD



- GB** Portable nothers
D Schere zum Ausschneiden von Ecken
PL Nożyce do wycinania naroży
RUS Ножницы для наружных углов
CZ Nůžky na vystřihování rohů
H Sarokkivágó olló
RO Foarfeca pt. taierea colturilor

- F** Ciseaux pour le coupage des coins
I Cesioie per taglio reggetta in angoli
E Tijera para esquinas
CN 截角器

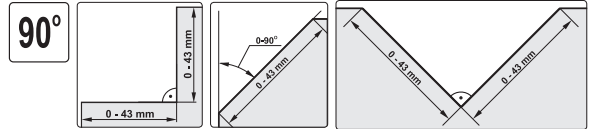

COLOR BOX



YATO	L (mm)	Box
YT-1939	300	15

- GB** Straight pliers
D Zange zum Blechbiegen
PL Kleszcze do gięcia blach
RUS Клещи с тупым ножом для жести
CZ Kleště na ohýbání plechu
H Falcfogó
RO Cleste pt. indoirea tablei
F Pince à fléchir la tôle
I Taglie per la lamiera

- E** Tenzas para doblar hojalata
CN 钣金钳

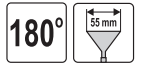
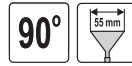

YATO	L (mm)	Box
YT-5416	280	10/20

YATO	L (mm)	Box
YT-5417	260	10/20

YATO	L (mm)	Box
YT-5415	280	10/20

- GB** Single seam clencher
D Klemme für Einfachfalz
PL Zaciskacz rąbka pojedynczego
RUS Зажим отдельного фальца
CZ Uzavírač jednoduché drážky
H Falclezáró fogó
RO Clema pt. falt simplu
F Plieur manuel tôle (rebord singulier)
I Griffa
E Pinza para costura individual
CN 屋顶施工工具

- GB** Double seam clencher
D Klemme für Doppelfalz
PL Zaciskacz rąbka podwójnego
RUS Зажим двойного фальца
CZ Uzavírač dvojité drážky
H Duplafalclezáró fogó
RO Clema pt. falt dublu
F Plieur manuel tôle (rebord double)
I Griffa
E Pinza para costura doble
CN 屋顶施工工具

- GB** Eaves turner
D Kantvorrichtung für Dachtraufe
PL Kantownik okapu
RUS Угольник навеса
CZ Ohýbačka okapnice
H Ereszperemező fogó
RO Cornier streasina
F Cintreuse d'avant-toit
I Griffa
E Volteador de alero
CN 屋顶施工工具

- GB** Eaves clencher
D Klemme für Dachtraufe
PL Zaciskacz okapu
RUS Зажим навеса
CZ Uzavírač okapnice
H Ereszperemező fogó
RO Clema pt. streasina
F Cintreuse d'avant-toit
I Griffa
E Pinza para alero
CN 屋顶施工工具



YATO	Ø (mm) pipe / rurki	mm	Box
YT-5400	18	480x220	5



YATO	Ø (mm) pipe / rurki	mm	Box
YT-5402	18	480x220	5



YATO	Ø (mm) pipe / rurki	mm	Box
YT-5404	18	450x200	5



YATO	Ø (mm) pipe / rurki	mm	Box
YT-5405	18	450x200	5

- GB** Drainpipe hooks bender
D Biegewerkzeug für Dachrinnenhaken
PL Zaginacz haków rynnowych
RUS Прибор для загибания крюков для водосточных желобов
CZ Ohýbačka okapových háků
H Ereszcsatorna-tartóvas hajlító
RO Dispozitiv pt. indoit carlige burlan
F Cintreuse pour crochets de gouttière
I Utensile per gancio
E Herramienta para doblar los ganchos para canalones
CN 弯管器



YATO	L (mm)	Box
YT-5410	680	4

- GB** Pipe crimper
D Rohreinziehange mit 5 Klingen
PL Szczypce do karbowania rur
RUS Клещи „гофра”
 прямые усиленные
CZ Kleště krepovací
H Krepelő kullancsok
RO Cleste gofrare burlane
F Pince a gaufrer 5 lames
I Pinza per corrugare tubi
E Crimpadora de tubos
CN 波浪剪



HALF DOUBLE
BLISTER



260 mm LOCK SYSTEM SYSTEM BLOKADY

YATO	L (mm)	
YT-22380	260	6/36

- GB** Wire tying twister hook
D Rödeldraht-Drillkurbel
PL Klucz do wiązania drutu zbrojeniowego
RUS Крючок для вязки арматуры
CZ Radlovačka
H Huzalsodró
RO Dispozitiv pt. legat fier beton
F Lieur
I Gancho per legare armature
E Gancho para amarrar alambre
CN 钢筋钩

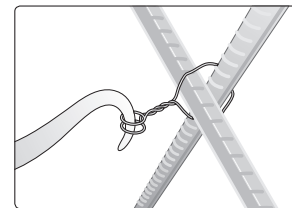

210 mm

SLIDING CARD

YATO	L (mm)	
YT-54230	210	10/100

- GB** Automatic twister hook for wire tying
D Rödeldraht-Drillkurbel
PL Klucz automatyczny do skręcania drutu
RUS Автоматический крюк для вязки арматуры
CZ Spirálový vazač
H Huzalsodró készülék
RO Dispozitiv automat pt. legat fier beton
F Lieur automatique
I Torcifilo automatico
E Gancho para amarrar alambre automatico
CN 自动伸缩钢筋钩

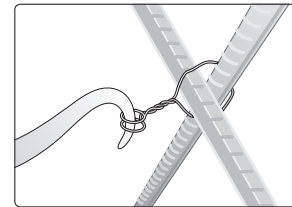

300 mm

YATO	L (mm)	
YT-54233	300	10/30

- GB** Rectangular floating rule
D Setzlatte 2 Libellen
PL Łata murarska
RUS Правило-уровень
CZ Lať zednická s libelami
H Ólesléc, téglalap keresztmetszetű
RO Dreptar cu 2 bule
F Niveau à bulle
I Livella
E Nivel de albañil
CN 刮板

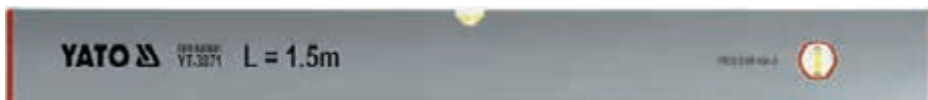

ACCURACY 0.057° = 1 mm/m 2 PRECISION VIALS LIBELLE

YATO	L (mm)	
YT-3071	1500	10
YT-3072	2000	10
YT-3073	2500	10
YT-3074	3000	10



YATO	L (mm)	
YT-3076	1500	10
YT-3077	2000	10
YT-3078	2500	10
YT-3079	3000	10

- GB** Trapezoid floating rule
D Abziehlatte mit Trapezprofil
PL Łata tynkarska
RUS Правило трапециевидное
CZ Lať mališská
H Ólesléc, trapézoid keresztmetszetű
RO Dreptar trapezoidal
F Niveau à bulle
I Livella trapezoidale
E Nivel de albañil
CN 梯形刮板



YATO	L (mm)	
YT-3081	1500	10
YT-3082	2000	10
YT-3083	2500	10
YT-3084	3000	10

- GB** Knife for roofing paper
D Messer zum Schneiden von Pappe
PL Nóż do ścięcia papy
RUS Нож для резки рубероида
CZ Nůž k řezání lepenky
H Kátrányapáríróó olló
RO Cutter pt. tăierea cartonului asfaltat
F Couteau pour carton
I Coltello per tagliare cartone bituminoso
E Cuchilla para cortar cartón alquitranado
CN 多功能刀



SLIDING CARD

90 mm STAINLESS STEEL STAŁ NERDZEWNA

YATO	L (mm)	
YT-7620	230	12/60

GB Knife for mineral wool
D Messer zum Schneiden von Bauisolierungen
PL Nóż do cięcia izolacji budowlanych
RUS Нож для резки строительной изоляции

CZ Nůž k řezání stavebních izolačních hmot
H Kés épületszigetelés vágásához
RO Cutter pt. tăierea izolațiilor
F Couteau pour isolants

I Coltello per tagliare l'isolamento di costruzione
E Cuchilla para cortar aislamiento de construcción
CN 多功能刀

SLIDING
CARD



YATO	L (mm)	
YT-7623	500	10/50



YATO	L (mm)	
YT-7624	480	10/50

GB Thermal knife for polystyrene foam
D Thermomesser für Styropor
PL Nóż termiczny do styropianu
RUS Термонож для пенопласта

CZ Termický nůž na pěnový polystyrén
H Polisztírol vágó hőkés
RO Cuțit termic pt. stropian
F Couteau thermique à styrofoam

I Coltello termico per polistirolo
E Cuchilla térmica para poliestireno
CN 热切割刀

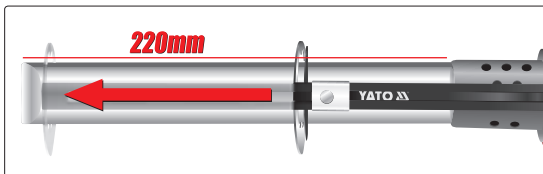
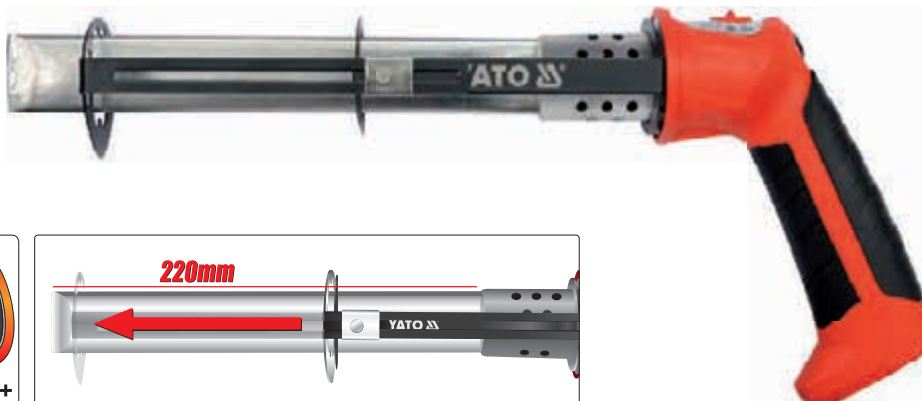
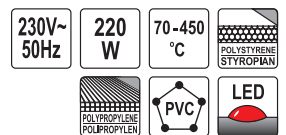

COLOR BOX



YATO	W	L (mm)	
YT-82190	220	220	10

GB Electric hoist
D Elektro-Seilwinde
PL Elektryczny wciągnik linowy
RUS Электрическая канатная лебедка
CZ Elektrický naviják kladkostroj
H Elektromos csőrőb
RO Troliu electric cu cablu
F Treuil électrique à corde
I Verricello elettrico
E Cabria eléctrica de cuerdas
CN 电动葫芦



COLOR BOX



YATO	W	
YT-5901	500	2

$L_{pA} \leq 70$ dB;
 $L_{wA} \leq 85$ dB

YATO	W	
YT-5902	550	2

$L_{pA} \leq 70$ dB;
 $L_{wA} \leq 85$ dB

YATO	W	
YT-5904	900	2

$L_{pA} \leq 70$ dB;
 $L_{wA} \leq 85$ dB

YATO	W	
YT-5905	1050	2

$L_{pA} \leq 70$ dB;
 $L_{wA} \leq 85$ dB

- GB Rubber protection extension cord
- D Gummiisolierte Verlängerungsschnur
- PL Przedłużacz w osłonie gumowej
- RUS Удлинитель с резиновой изоляцией
- CZ Prodlužovací kabel s gumovou izolací
- H Gumi szigetelésű hosszabbító
- RO Cablu prelungitor cauciuc
- F Rallonge électrique
- I Prolunga in gomma
- E Cable de extensión con protección de caucho
- CN 电缆延长线



CABLE 3G1.5 mm²
H05RR-F KABEL

CABLE 3G2.5 mm²
H05RR-F KABEL

YATO	L (m)	
YT-81021	10	8
YT-81022	20	4
YT-81023	30	4
YT-81024	40	2

YATO	L (m)	
YT-8100	20	4
YT-8101	30	2
YT-8102	40	2



CABLE 3G1.5 mm²
H07RN-F KABEL

CABLE 3G1.5 mm²
H07RN-F KABEL

YATO	L (m)	
YT-8111	5	16
YT-8112	10	8

YATO	L (m)	
YT-8116	10	4
YT-81162	20	4

- GB Cable reel
- D Kabeltrommel
- PL Przedłużacz zwijany
- RUS Удлинитель электрический
- CZ Bubnový prodlužovač
- H Kábeldob
- RO Prelungitor pe tambur
- F Rallonge électrique sur tambour enrouleur
- I Avvolgicavo con bobina
- E Cable de prolongación de tambor
- CN 电缆延长线

IP44 16A

CABLE 3G1.5 mm²
H05RR-F KABEL

E & F TYPE / TYP E TYPE / TYP

230V~50Hz

- GB Cable reel
- D Kabeltrommel
- PL Przedłużacz zwijany
- RUS Удлинитель электрический
- CZ Bubnový prodlužovač
- H Kábeldob
- RO Prelungitor pe tambur
- F Rallonge électrique sur tambour enrouleur
- I Avvolgicavo con bobina
- E Cable de prolongación de tambor
- CN 电缆延长线

IP44 16A

CABLE 3G2.5 mm²
H05RR-F KABEL

E & F TYPE / TYP E TYPE / TYP

PLASTIC REEL BEBEN PLÁSTIKOVY 230V~50Hz

- GB Drum power extension cord
- D Verlängerungstrommel für Kraftstrom
- PL Przedłużacz bębnowy silowy
- RUS Силовой удлинитель барабанного типа
- CZ Prodlužovací kabel silový na bubnu
- H Háromfázisú hosszabbító dob
- RO Derulator cu tambur
- F Rallonge électrique sur tambour enrouleur
- I Avvolgicavo di forza
- E Cilindro de extensión de fuerza
- CN 电缆延长线

IP44 ~400V ~230V

CABLE 5G2.5 mm²
H07RN-F KABEL

3P+N+E 3P+N+E 2x 2P+E



- P_{max} = 1000 W coiled
- P_{max} = 1000 W zwinięty
- P_{max} = 3000 W uncoiled
- P_{max} = 3000 W rozwinięty

POLYBAG

- P_{max} = 1200 W coiled
- P_{max} = 1200 W zwinięty
- P_{max} = 3600 W uncoiled
- P_{max} = 3600 W rozwinięty

POLYBAG

- ~230V; 2P+E
- P_{max} = 1200 W coiled
- P_{max} = 1200 W zwinięty
- P_{max} = 3000 W uncoiled
- P_{max} = 3000 W rozwinięty
- ~400V; 3P+N+E
- P_{max} = 3000 W coiled
- P_{max} = 3000 W zwinięty
- P_{max} = 9000 W uncoiled
- P_{max} = 9000 W rozwinięty

POLYBAG

YATO	L (m)	
YT-81052	20	2
YT-81053	30	2
YT-81054	40	2



YATO	L (m)	
YT-8106	30	1
YT-8107	40	1
YT-8108	50	1

YATO	L (m)	
YT-8120	25	1

- GB** Spiral bar mixer
D Rundstabrührer für klebrige, geschmeidige Materialien
PL Mieszadło spiralne prętowe
RUS Краскомешалка
- CZ** Spirálové míchadlo drátové
H Spirális, pálcás keverő
RO Malaxor pt. vopsea
F Malaxeur spiral
- I** Mescolatore spirale
E Agitadore pala/cinta
CN 搅拌器





- application: powder materials, general-purpose adhesives, gypsum surface finishing mixes, epoxy grouts
- zastosowanie: materiały sypkie, gotowe zaprawy klejowe, masy szpachlowe, zaprawy do spoinowania

YATO 	Ø (mm)	L (mm)	shank / uchwyt	max. mixing capacity / max. wydajność mieszania (kg)	
YT-5490	85	410	HEX	4-9	30
YT-5491	100	600	HEX	6-16	16
YT-5492	85	450	SDS+	4-9	30
YT-5493	100	600	SDS+	6-16	16

- GB** Spiral mixer
D Rondenrührer für dünnflüssige Materialien
PL Mieszadło spiralne
RUS Краскомешалка
- CZ** Spirálové míchadlo
H Spirális keverő
RO Malaxor pt. vopsea
F Malaxeur spiral
- I** Mescolatore spirale
E Agitador de cinta helicoidal
CN 搅拌器





- application: emulsion paints, acrylic paints, lacquers, stains, other liquid materials
- zastosowanie: farby emulsyjne, farby akrylowe, lakiery, bejce, inne materiały płynne

YATO 	Ø (mm)	L (mm)	shank / uchwyt	max. mixing capacity / max. wydajność mieszania (kg)	
YT-5494	80	400	HEX	5-10	30
YT-5496	100	600	SDS+	15-30	20

- GB** Double spiral mixer
D Wendelrührer für klebrige, zähe Materialien
PL Mieszadło spiralne podwójne
RUS Краскомешалка
- CZ** Spirálové míchadlo dvojitě
H Dupla spirális keverő
RO Malaxor spirala dubla pt. vopsea
F Malaxeur spiral double
- I** Mescolatore a doppia spirale
E Agitador de cinta helicoidal doble
CN 搅拌器





- application: general-purpose adhesives, masonry mortars, jointless floors, thin-layer mineral plasters, gypsum surface finishing mixes, isolation masses
- zastosowanie: zaprawy klejowe, zaprawy murarskie, jastrych, tynki strukturalne, masy szpachlowe, masy izolacyjne

YATO 	Ø (mm)	L (mm)	shank / uchwyt	max. mixing capacity / max. wydajność mieszania (kg)	
YT-5497	70	400	HEX	5-10	20
YT-5499	100	600	HEX	10-20	16
YT-5500	120	600	HEX	15-25	14
YT-5501	100	600	SDS+	10-20	16
YT-5502	120	600	SDS+	15-25	14
YT-5503	120	600	M14	15-25	14
YT-5504	160	600	M14	20-30	8

- GB** Triple spiral mixer
D Wendelrührer für schwere, zähe Materialien
PL Mieszadło spiralne potrójne
RUS Краскомешалка
- CZ** Spirálové míchadlo trojitě
H Tripla spirális keverő
RO Malaxor spirala tripla pt. vopsea
F Malaxeur spiral triple
- I** Mescolatore a triplo spirale
E Agitador de cinta helicoidal triple
CN 搅拌器



- application: mortars, concrete, plasters, other semi-fluid materials with sand or gravel filling
- zastosowanie: zaprawy, beton, tynki, inne półpłynne, lepkie materiały z wypełnieniem piaskowym lub żwirowym

YATO 	Ø (mm)	L (mm)	shank / uchwyt	max. mixing capacity / max. wydajność mieszania (kg)	
YT-5505	100	600	HEX	10-20	16
YT-5506	120	600	SDS+	15-25	12
YT-5507	120	600	M14	15-25	12
YT-5508	160	600	M14	20-30	8

GB Carpenter's pencil
D Zimmermannsbleistifte
PL Ołówek stolarski
RUS Карандаш столярный

CZ Tesařská tužka
H Asztalos ceruza
RO Creion de tâmplărie
F Crayon menuisier

I Matita per falegnami
E Lapiz de carpintero
CN 木工铅笔

COLOR BOX



144
PCS

HB



YATO	L (mm)	W (mm)	PCS packing:	
YT-6925	245	15	144	8



YATO	L (mm)	W (mm)	PCS packing:	
YT-6926	245	12	144	8

GB Masonry pencil
D Maurerbleistift
PL Ołówek murarski
RUS Карандаш каменщика

CZ Tužka zednická
H Kőműves keverő
RO Creion
F Crayon maçon

I Matita per muratori
E Lapiz de albañil
CN 木工铅笔

COLOR BOX



144
PCS

HB



YATO	L (mm)	W (mm)	PCS packing:	
YT-6927	245	12	144	8

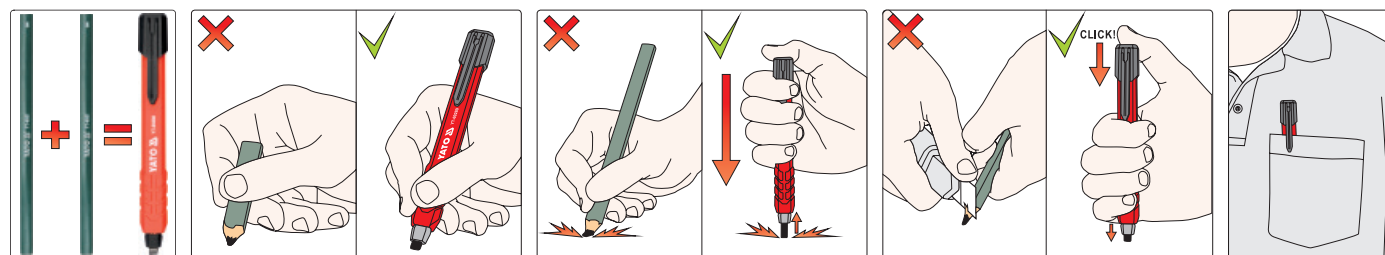

GB Automatic carpenters / masonry pencil
D Tischler- und Maurer-Druckstift
PL Ołówek stolarski / murarski automatyczny
RUS Автоматический столярный карандаш / карандаш каменщика

CZ Stolařská / zednická tužka automatická
H Asztalos / kőműves töltőceruza
RO Creion de tâmplărie / zidărie mecanic
F Crayon menuisier / maçon automatique

I Matita per falegnami e carpentieri
E Lápiz automático de carpintero / albanil
CN 自动木工铅笔

HB



YATO	
YT-6928	50/1000

13

GB Automatic carpenters / masonry pencil with spare leads
D Tischler- und Maurer-Druckstift + zusätzliche Bleistiftmine
PL Ołówek stolarski / murarski automatyczny + dodatkowe grafity

RUS Автоматический столярный карандаш / карандаш каменщика + дополнительный графит
CZ Stolařská / zednická tužka automatická + náhradní tuha
H Asztalos / kőműves töltőceruza + tartalék grafit
RO Creion de tâmplărie / zidărie mecanic + grafit adițional

F Crayon menuisier / maçon automatique
I Matita per falegnami e carpentieri ricaricabile
E Lápiz automático de carpintero / albanil + mina adicional
CN 自动木工铅笔组套

1+5
LEADS
WKŁADY

HB



YATO	
YT-69281	144

GB Lead HB
D Bleistiftmine HB
PL Grafit HB
RUS Графит HB
CZ Tuha HB
H Grafit HB

RO Grafit HB
F Mine HB
I Grafite HB
E Mina HB
CN 自动木工铅笔笔芯

PLASTIC TUBE



5
LEADS
WKŁADÓW

HB

for / dla: YT-69280, YT-69281

YATO	
YT-69285	20/1000

GB Lead H2
D Bleistiftmine H2
PL Grafit H2
RUS Графит H2
CZ Tuha H2
H Grafit H2

RO Grafit H2
F Mine H2
I Grafite H2
E Mina H2
CN 自动木工铅笔笔芯

PLASTIC TUBE



5
LEADS
WKŁADÓW

H2

for / dla: YT-69280, YT-69281

YATO	
YT-69286	20/1000

GB Lead HB
D Bleistiftmine HB
PL Grafit HB
RUS Графит HB
CZ Tuha HB
H Grafit HB

RO Grafit HB
F Mine HB
I Grafite HB
E Mina HB
CN 自动木工铅笔笔芯

PLASTIC TUBE



5
LEADS
WKŁADÓW

HB

WHITE
BIAŁY

for / dla: YT-69280, YT-69281

YATO	
YT-69287	20/1000

Memo

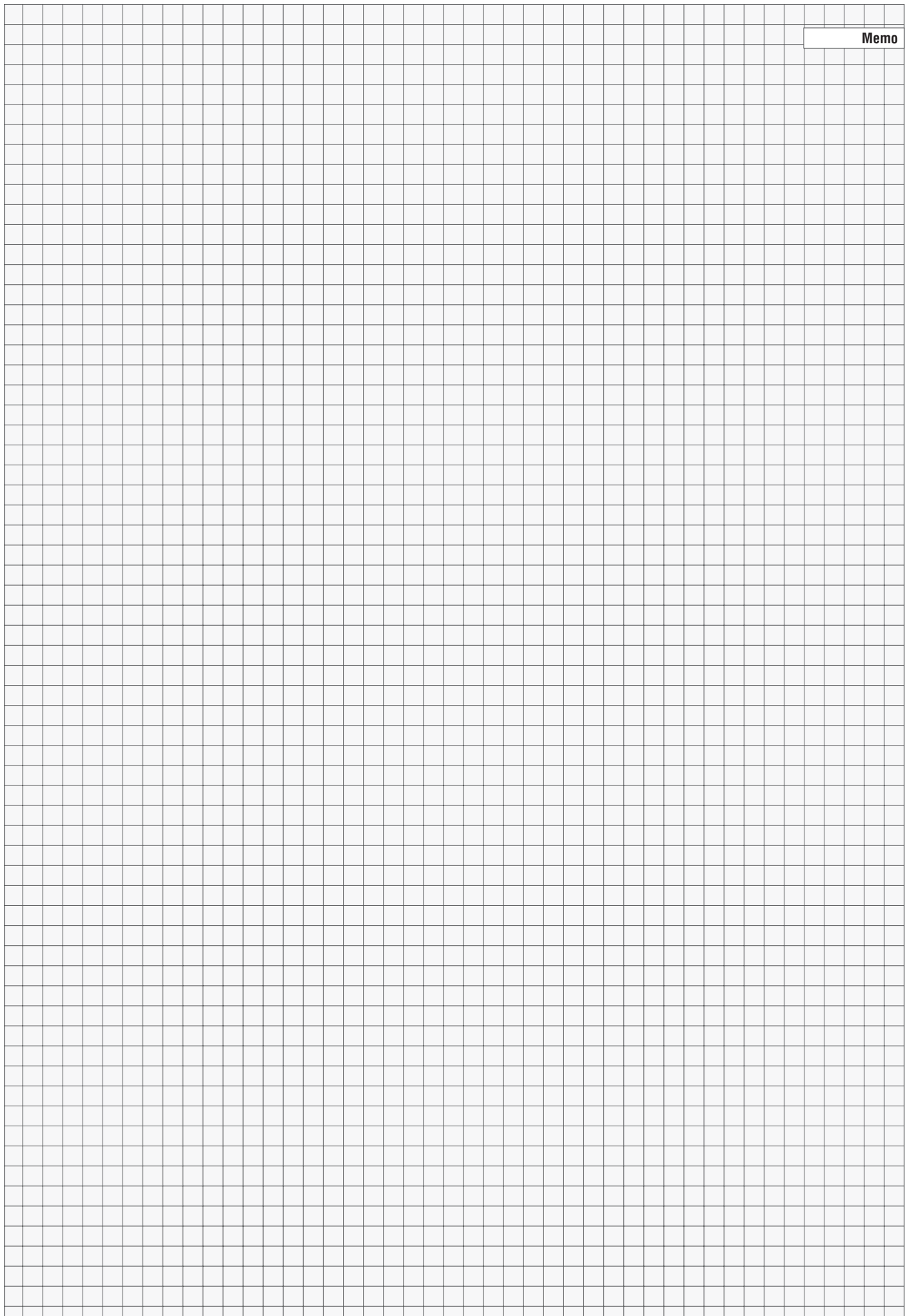

14

Measuring tools Narzędzia miernicze



Electric meters
Mierniki elektryczne

242



Micrometers
Mikrometry

245



Multimeters
Mierniki

242-243



Electronic measuring tools
Elektroniczne urządzenia pomiarowe

246



Measuring tapes
Miary zwijane

243-244



Levels
Poziomnice

247



Rulers
Przymiary

244



Feelers
Szczelinomierze

248



Try squares
Kątowniki stolarskie

244-245



Screw pitch gauges
Sprawdziany grzebieniowe do gwintów

248



Vernier calipers
Suwmiarki

245



GB Digital voltage tester
D Digitaler-Spannungsprüfer
PL Wskaźnik elektryczny
RUS Тестер напряжения цифровой

CZ Zkoušečka napětí digitální
H Digitális voltmérő
RO Tester digital pt. tensiune electrica

F Testeur de tension type tournevis
I Cerca fase digitale

E Indicador eléctrico
CN 数显测电笔



SLIDING CARD

12-250 V ~ / ---

50-500 Hz

TEST

LED DISPLAY WYSWIETLACZ

NO BATTERY NEEDED
 NE POTRZEBUJE BATERII

YATO
 YT-2861 20/500



LED NO BATTERY NEEDED
 NE POTRZEBUJE BATERII

YATO
 YT-2862 20/500



LED POWER "ZBIERKA" 3x1.5 V LR41 BATTERY BATERIA

YATO
 YT-28630 6/120

GB Analogue battery tester
D Analoges Batterieprüfgerät
PL Tester akumulatorów analogowy
RUS Аналоговый тестер аккумуляторов
CZ Analogový tester akumulátorů
H Analóg akkuteszter
RO Tester acumulatori analog
F Testeur de charge batterie
I Tester analogico per batteria
E Tester analógico para acumuladores
CN 电池测试器

COLOR BOX
 6 V
 12 V
 CCA 200-1000 A



GB Analogue battery tester
D Analoges Batterieprüfgerät
PL Tester akumulatorów analogowy
RUS Аналоговый тестер аккумуляторов
CZ Analogový tester akumulátorů
H Analóg akkuteszter
RO Tester acumulatori analog
F Testeur de charge batterie
I Tester analogico per batteria
E Tester analógico para acumuladores
CN 电池测试器

COLOR BOX
 12 V
 LED DISPLAY
 CCA 150-1400 A



GB Battery tester
D Batterieprüfgerät
PL Tester akumulatorów
RUS Тестер аккумуляторов
CZ Tester akumulátorů
H Akkuteszter
RO Tester acumulatori
F Testeur électronique de charge batterie et alternateur
I Tester per batteria
E Tester para acumuladores
CN 电池测试器

DOUBLE BLISTER
 12 V
 BATTERY TEST
 TEST AKUMULATORA
 ALTERNATOR TEST
 TEST ALTERNATORA



YATO
 YT-8310 10



YATO
 YT-8311 10



YATO
 YT-83101 12/72

GB Digital universal multimeter
D Universell digital Messgerät
PL Cyfrowy miernik uniwersalny
RUS Универсальный цифровой измеритель
CZ Digitální multimetr univerzální
H Digitális multiméter
RO Multimetru digital universal
F Multimètre numérique
I Universale tester digitale
E Manómetro digital universal
CN 数字万用表

COLOR BOX



U 0-500 V ~ V
 U 0-500 V ~ V
 I 0-5 A ~ A
 R 0-2 MΩ
 h_{FE} PNP NPN
 5V_{P-P}

YATO
 YT-73080 50



U 0-300 V ~ V
 U 0-300 V ~ V
 I 0-10 A ~ A
 I 0-10 A ~ A
 R 0-20 MΩ
 C 0-1000 μF
 T -20~+1000°C
 h_{FE} PNP NPN
 AUTO RANGE AUTO ZAKRES
 AUTO POWER OFF

YATO
 YT-73084 44

GB Digital universal multimeter
D Universell digital Messgerät
PL Cyfrowy miernik uniwersalny

RUS Универсальный цифровой измеритель
CZ Digitální multimetr univerzální

H Digitális multiméter
RO Multimetru digital universal
F Multimètre numérique

I Universale tester digitale
E Manómetro digital universal
CN 数字万用表

NYLON CASE & COLOR BOX

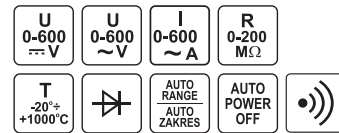
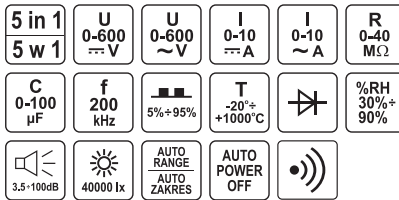
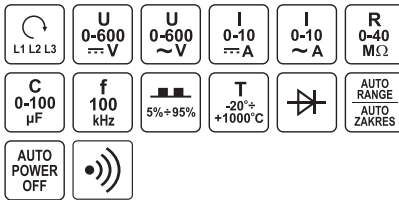

YATO		
YT-73086	24	

YATO		
YT-73087	24	

YATO		
YT-73091	20	

GB Measuring tape CZ Měřicí pásmo F Ruban à mesurer E Flexómetro
D Rollbandmass H Mérőszalag I Misura di nastro CN 卷尺
PL Miara zwijana RO Rulete din pinza
RUS Рулетка



3m
16mm

5m
19mm

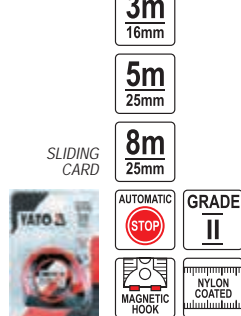
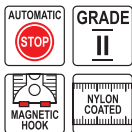

3m
16mm

5m
25mm

8m
25mm

SLIDING CARD



YATO	L (m)	size / rozmiar (mm)	
YT-7103	3	16	12/120
YT-7105	5	19	12/120

YATO	L (m)	size / rozmiar (mm)	
YT-7110	3	16	12/120
YT-7111	5	25	12/120
YT-7112	8	25	6/60



3m
16mm

5m
19mm

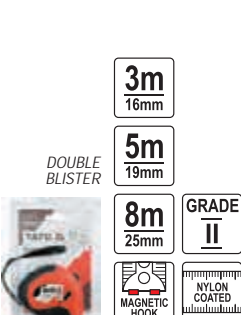
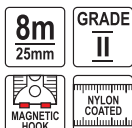

3m
16mm

5m
19mm

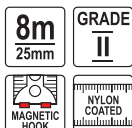

YATO	L (m)	size / rozmiar (mm)	
YT-7126	3	16	12/120
YT-7127	5	19	12/120
YT-7128	8	25	6/60



3m
16mm

5m
19mm

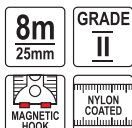

YATO	L (m)	size / rozmiar (mm)	
YT-7129	3	16	12/120
YT-7130	5	19	12/120
YT-7131	8	25	6/60

GB Measuring tape CZ Měřicí pásmo F Ruban à mesurer E Flexómetro
 D Rollbandmass H Mérőszalag I Misura di nastro CN 卷尺
 PL Miara zwijana RO Rulete din pinza
 RUS Рулетка

PLASTIC HANGER



3m
16mm

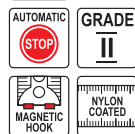

YATO	L (m)	size / rozmiar (mm)	
YT-71055	3	16	12/120
YT-71056	5	19	12/120
YT-71057	5	25	12/120
YT-71058	8	25	6/60

3m
16mm

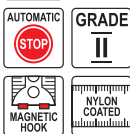

YATO	L (m)	size / rozmiar (mm)	
YT-71060	3	16	12/120
YT-71061	5	19	12/120
YT-71063	5	25	6/60

GB Steel measuring tape F Ruban à mesurer acier
 D Rollbandmass I Misura di nastro a acciaio
 PL Taśma miernicza stalowa E Cinta de medir de acero
 RUS Мерная лента стальная CN 长钢卷尺
 CZ Měřicí pásmo ocelové
 H Acél mérőszalag
 RO Ruleta sticla

20m 30m 50m
13mm 15mm 13mm



ABS

GRADE II



DOUBLE BLISTER

YATO	L (m)	size / rozmiar (mm)	
YT-71580	20	13	40
YT-71581	30	13	40
YT-71582	50	13	20

GB Fibreglass measuring tape F Ruban à mesurer fibre-verre
 D Rollbandmass I Misura di nastro in fibra di vetro
 PL Taśma miernicza z włókna szklanego E Cinta de medir - fibra cristal
 RUS Мерная лента фибергласс CN 长纤维卷尺
 CZ Měřicí pásmo - skleněné vlákno
 H Mérőszalag - üvegszál
 RO Ruleta fibra sticla

20m 30m 50m
13mm 15mm 13mm



ABS

GRADE II



DOUBLE BLISTER

YATO	L (m)	size / rozmiar (mm)	
YT-71570	20	15	40
YT-71571	30	15	40
YT-71572	50	15	20

14

GB Fibreglass measuring tape F Ruban à mesurer fibre-verre
 D Rollbandmass I Misura di nastro in fibra di vetro
 PL Taśma miernicza z włókna szklanego E Cinta de medir - fibra cristal
 RUS Мерная лента фибергласс CN 长纤维卷尺
 CZ Měřicí pásmo - skleněné vlákno
 H Mérőszalag - üvegszál
 RO Ruleta fibra sticla



30m 50m
15mm 13mm



ABS

COLOR BOX

YATO	L (m)	size / rozmiar (mm)	
YT-71540	30	15	10
YT-71541	50	15	10

GB Aluminium ruler RO Riglă tâmplar din aluminiu
 D Alu zeichen-massstab F Règle aluminium
 PL Przymiar aluminiowy I Righello di alluminio
 RUS Линейка алюминиевая E Regla de aluminio
 CZ Měřicí lat' hliníková CN 铝合金直尺
 H Asztalos vonalzó, alumínium

AI



YATO	L (mm)	
YT-7070	300	25/100
YT-7071	600	10/50

GB Aluminium try square RO Echer de tâmplărie
 D Anschlagwinkel F Equerre en aluminium
 PL Kątownik aluminiowy I Angolo di alluminio
 RUS Угльник столярный E Escuadra de aluminio
 CZ Truhlářský úhelník CN 铝合金角尺
 H Asztalos derékszög

AI

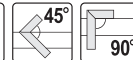



YATO	L (mm)	
YT-7080	250	6/36
YT-7081	300	6/36
YT-7082	350	6/36

- GB** Try square
D Anschlagwinkel
PL Kątownik stalowy
RUS Угольник столярный
CZ Truhlářský úhelník
H Asztalos derékszög
RO Echer de tâmplărie
F Equerre
I Angolo di acciaio
E Escuadra
CN 不锈钢角尺



STAINLESS
STEEL
STAL
NERZEWA



YATO 	size / rozmiar (mm)	
YT-7083	150 x 300	25/100
YT-7084	250 x 500	10/50

- GB** Vernier caliper
D Messschieber
PL Suwmiarka
RUS Штангенциркуль
CZ Posuvné měřtko
H Tolóméró
RO Şubler
F Pied à coulisse
I Calibro
E Calibre
CN 游标卡尺



+/-
0.02
mm

SCALE
SKALA
mm
inch

STAINLESS
STEEL
STAL
NERZEWA

PLASTIC CASE
& COLOR BOX



YATO 	range / zakres (mm)	
YT-7200	0-150	10/50

- GB** Digital caliper
D Digital Messschieber
PL Suwmiarka elektroniczna
RUS Штангенциркуль
электронный
CZ Posuvné měřtko
elektronické
H Digitális tolóméró
RO Şubler electronic
F Pied à coulisse
electronique
I Calibro
E Calibre electrónico
CN 数显卡尺



+/-
0.03
mm

SCALE
SKALA
mm
inch

STAINLESS
STEEL
STAL
NERZEWA

BATTERY
SR44
1.55V

PLASTIC CASE
& COLOR BOX



YATO 	range / zakres (mm)	
YT-7201	0-150	10/50

- GB** Vernier caliper
D Messschieber
PL Suwmiarka
RUS Штангенциркуль
CZ Posuvné měřtko
H Tolóméró
RO Şubler
F Pied à coulisse
I Calibro
E Calibre
CN 游标卡尺





+/-
0.02
mm

SCALE
SKALA
mm
inch

STAINLESS
STEEL
STAL
NERZEWA

PLASTIC CASE
& COLOR BOX



YATO 	range / zakres (mm)	
YT-72003	0-200	30
YT-72004	0-300	20

- GB** Micrometer
D Mikrometer
PL Mikrometr
RUS Микрометр



- CZ** Mikrometr
H Mikrométer
RO Micrometru
F Micromètre

- I** Micrometro
E Micrómetro
CN 外径千分尺

+/-
0.01
mm



PLASTIC CASE
& COLOR BOX

YATO 	range / zakres (mm)	
YT-72300	0-25	30
YT-72301	25-50	30
YT-72302	50-75	20
YT-72303	75-100	5/10

- GB** Micrometer with a digital display
D Mikrometer mit Digitalanzeige
PL Mikrometr z wyświetlaczem cyfrowym
RUS Микрометр с цифровым
индикатором
CZ Mikrometr s digitálním displejem

- H** Mikrométer digitális kijelzővel
RO Micrometru cu afişaj digital
F Micromètre
I Micrometro con digitale elettronico
E Micrómetro con pantalla digital
CN 杆径数显千分尺

+/-
0.01
mm

SCALE
SKALA
mm
inch

LCD
DISPLAY
WYŚWIETLACZ



PLASTIC CASE
& COLOR BOX

YATO 	range / zakres (mm)	
YT-72305	0-25	20

- GB Laser distance meter
- D Laserentfernungsmesser
- PL Dalmierz laserowy
- RUS Лазерный дальномер
- CZ Laserový měřič vzdálenosti
- H Lézeres távolságmérő
- RO Telemetru cu laser
- F Télémètre laser
- I Telemetro laser
- E Medidores láser de distancias
- CN 激光测距仪

COLOR BOX

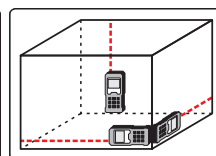
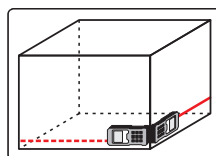
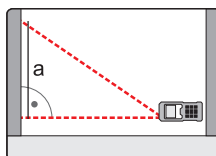
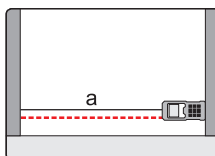

30 m
0.05-30 m
+/- 2 mm

20 MEMORY PAMIEĆ
7 MODES TRYBOW



YATO
YT-73124 40

40 m
0.05-40 m
+/- 2 mm

20 MEMORY PAMIEĆ
8 MODES TRYBOW



YATO
YT-73125 20

40 m
0.2-40 m
+/- 2 mm

20 MEMORY PAMIEĆ
10 MODES TRYBOW

CONSTANT ANGLE PITCH MEASUREMENT
CIĄGŁY POMIAR KĄTÓW NACHYLENIA

IP65



YATO
YT-73126 20

60 m
0.2-60 m
+/- 2 mm

20 MEMORY PAMIEĆ
10 MODES TRYBOW

CONSTANT ANGLE PITCH MEASUREMENT
CIĄGŁY POMIAR KĄTÓW NACHYLENIA

IP65



YATO
YT-73127 20

- GB Stud finder
- D Entfernungsmesser
- PL Wykrywacz profili i przewodów
- RUS Цифровой детектор
- CZ Digitální detektor
- H Digitális kereső műszer
- RO Detector digital
- F Détecteur de métaux et de câbles électriques
- I Detector digitale
- E Escáner de pared
- CN 墙体探测仪

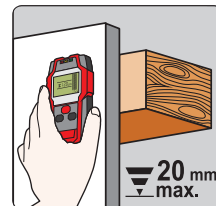
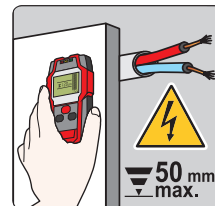
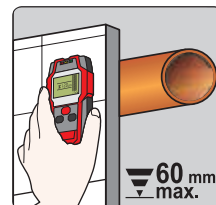
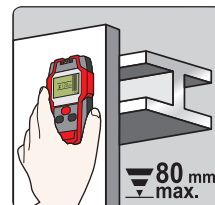

YATO
YT-73131 40

GB Aluminium level
D Wasserwaage
PL Poziomnica aluminiowa
RUS Уровень

CZ Vodováha
H Vízmerők
RO Cumpănă
F Niveau à bulle

I Livella
E Nivel
CN 铝合金水平尺



ACCURACY
DOKŁADNOŚĆ
0.057°
= 1.0 mm/m

3
PRECISION
VIALS
LIBELLE

1.5 mm
ALUMINIUM
HIGH QUALITY PROFILE
ALUMINIOWY
PROFIL WYSOKIEJ JAKOŚCI

SHOCK
PROOF
ODPORNA
NA WSTRZĄSY



YATO	L (mm)	
YT-3001	400	20/60
YT-3002	600	20/60
YT-3003	800	20/60
YT-3004	1000	20/60
YT-3005	1200	20/60



ACCURACY
DOKŁADNOŚĆ
0.057°
= 1.0 mm/m

3
PRECISION
VIALS
LIBELLE

1.5 mm
ALUMINIUM
HIGH QUALITY PROFILE
ALUMINIOWY
PROFIL WYSOKIEJ JAKOŚCI

YATO	L (mm)	
YT-3022	600	20/60
YT-3023	800	20/60
YT-3024	1000	30
YT-3025	1200	30
YT-3026	1500	30



ACCURACY
DOKŁADNOŚĆ
0.027°
= 0.5 mm/m

ALUMINIUM
HIGH QUALITY
PROFILE
ALUMINIOWY
PROFIL WYSOKIEJ
JAKOŚCI

3
PRECISION
VIALS
LIBELLE

YATO	L (mm)	
YT-30071	600	10/40
YT-30072	800	10/30
YT-30073	1000	10/20
YT-30074	1200	10/20



ACCURACY
DOKŁADNOŚĆ
0.027°
= 0.5 mm/m

ALUMINIUM
HIGH QUALITY
PROFILE
ALUMINIOWY
PROFIL WYSOKIEJ
JAKOŚCI

2
PRECISION
VIALS
LIBELLE

YATO	L (mm)	
YT-30061	600	10/40
YT-30062	800	10/30
YT-30063	1000	10/20
YT-30064	1200	10/20

GB Trapezoidal spirit level
D Trapezförmige Wasserwaage
PL Poziomnica trapezowa
RUS Трапецидальный уровень духа

CZ Vodováha trapezova
H Vízmerők trapéz
RO Nivelă trapezoidală
F Trapezes niveau

I Livella trapezoidale
E Trapezoides nivel
CN 水平尺



SHOCK
PROOF
ODPORNA
NA WSTRZĄSY

ALUMINIUM
HIGH QUALITY
PROFILE
ALUMINIOWY
PROFIL WYSOKIEJ
JAKOŚCI

ACCURACY
DOKŁADNOŚĆ
0.027°
= 0.5 mm/m



2
PRECISION
VIALS
LIBELLE

YATO	L (mm)	
YT-30370	250	60



3
PRECISION
VIALS
LIBELLE

YATO	L (mm)	
YT-30375	600	24

GB Electronic laser level
D Elektronische laser Wasserwaage
PL Poziomnica elektroniczna z laserem
RUS Уровни электронные лазерные

CZ Úrovně elektronické laser
H Elektronikus vízmértek lézeres
RO Nivelurile laser electronice
F Niveaux laser électronique

I Livella elettronica con laser
E Niveles láser electrónica
CN 数显激光水平尺

2
PRECISION
VIALS
LIBELLE

ALUMINIUM
HIGH QUALITY
PROFILE
ALUMINIOWY
PROFIL WYSOKIEJ
JAKOŚCI

ACCURACY
DOKŁADNOŚĆ
0.027°
= 0.5 mm/m

LASER
ACCURACY
DOKŁADNOŚĆ
LASERA
± 0.3 mm /
10 m

WORK
TEMPERATURE
TEMPERATURA
PRACY
0°C-60°C

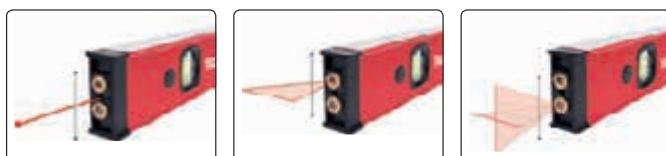

DOUBLE
BLISTER

YATO	L (mm)	
YT-30400	610	20

- GB** Feeler **RO** Lere
D Fühlerlehre **F** Palpeur
PL Szczelinomierz **I** Spessimetro
RUS Щупы **E** Calibre de fisuras
CZ Spároměr **CN** 塞尺
H Hézagmérő

DOUBLE
BLISTER



100 mm **10 mm** **17 GAUGES LISTKÓW**  **TAPER ZBIĘŻNY**

200 mm **12.8 mm** **17 GAUGES LISTKÓW**  **PARALLEL RÓWNOLEGŁY**

YATO	L (mm)	width / szerokość	size / rozmiar	
YT-7220	100	10	0.02; 0.03; 0.04; 0.05; 0.06; 0.07; 0.08; 0.09; 0.10; 0.15; 0.20; 0.25; 0.30; 0.40; 0.50; 0.75; 1.00	10/200

YATO	L (mm)	width / szerokość	size / rozmiar	
YT-7221	200	12.8	0.02; 0.03; 0.04; 0.05; 0.06; 0.07; 0.08; 0.09; 0.10; 0.15; 0.20; 0.25; 0.30; 0.40; 0.50; 0.75; 1.00	10/100



100 mm **10 mm** **10 GAUGES LISTKÓW**  **TAPER ZBIĘŻNY**

200 mm **12.8 mm** **14 GAUGES LISTKÓW**  **PARALLEL RÓWNOLEGŁY**

YATO	L (mm)	width / szerokość	size / rozmiar	
YT-7222	100	10	0.05; 0.06; 0.07; 0.08; 0.09; 0.10; 0.20; 0.30; 0.40; 0.50	10/100

YATO	L (mm)	width / szerokość	size / rozmiar	
YT-7223	200	12.8	0.05; 0.06; 0.07; 0.08; 0.09; 0.10; 0.15; 0.20; 0.25; 0.30; 0.35; 0.40; 0.45; 0.50	10/100

- GB** Screw pitch gauges
D Gewinde-Messlehre
 Lehrenblätter
PL Sprawdzian grzebieniowy do gwintów
RUS Резьбомер
CZ Test hřebení
H Menetsablon
RO Set lere filet
F Manometre pour filetage
I Pettine per filetti
E Galga para roscas
CN 鑽徑真

SLIDING
CARD



24 **BLADES** **OSTRZA**
METRIC **METRYCZNE**
 0.25-6.0 mm
60°

YATO	thread types / rodzaje gwintów		
	metric / metryczne (mm)		
YT-29980	0.25; 0.3; 0.35; 0.4; 0.45; 0.5; 0.6; 0.7; 0.75; 0.8; 0.9; 1.0; 1.25; 1.5; 1.75; 2.0; 2.5; 3.0; 3.5; 4.0; 4.5; 5.0; 5.5; 6.0		30/300



28 **BLADES** **OSTRZY**
WHITWORTH
 4-62
55°

YATO	thread types / rodzaje gwintów		
	Whitworth		
YT-29982	4; 4.5; 5; 6; 7; 8; 9; 10; 11; 12; 13; 14; 15; 16; 18; 20; 22; 24; 25; 26; 28; 30; 32; 36; 40; 48; 60; 62		30/300



52 **BLADES** **OSTRZA**
METRIC **METRYCZNE**
 0.25-6.0 mm
60° **WHITWORTH**
 4-62
55°

YATO	thread types / rodzaje gwintów		
	metric / metryczne (mm)	Whitworth	
YT-29984	0.25; 0.3; 0.35; 0.4; 0.45; 0.5; 0.6; 0.7; 0.75; 0.8; 0.9; 1.0; 1.25; 1.5; 1.75; 2.0; 2.5; 3.0; 3.5; 4.0; 4.5; 5.0; 5.5; 6.0	4; 4.5; 5; 6; 7; 8; 9; 10; 11; 12; 13; 14; 15; 16; 18; 20; 22; 24; 25; 26; 28; 30; 32; 36; 40; 48; 60; 62	20/200

Memo

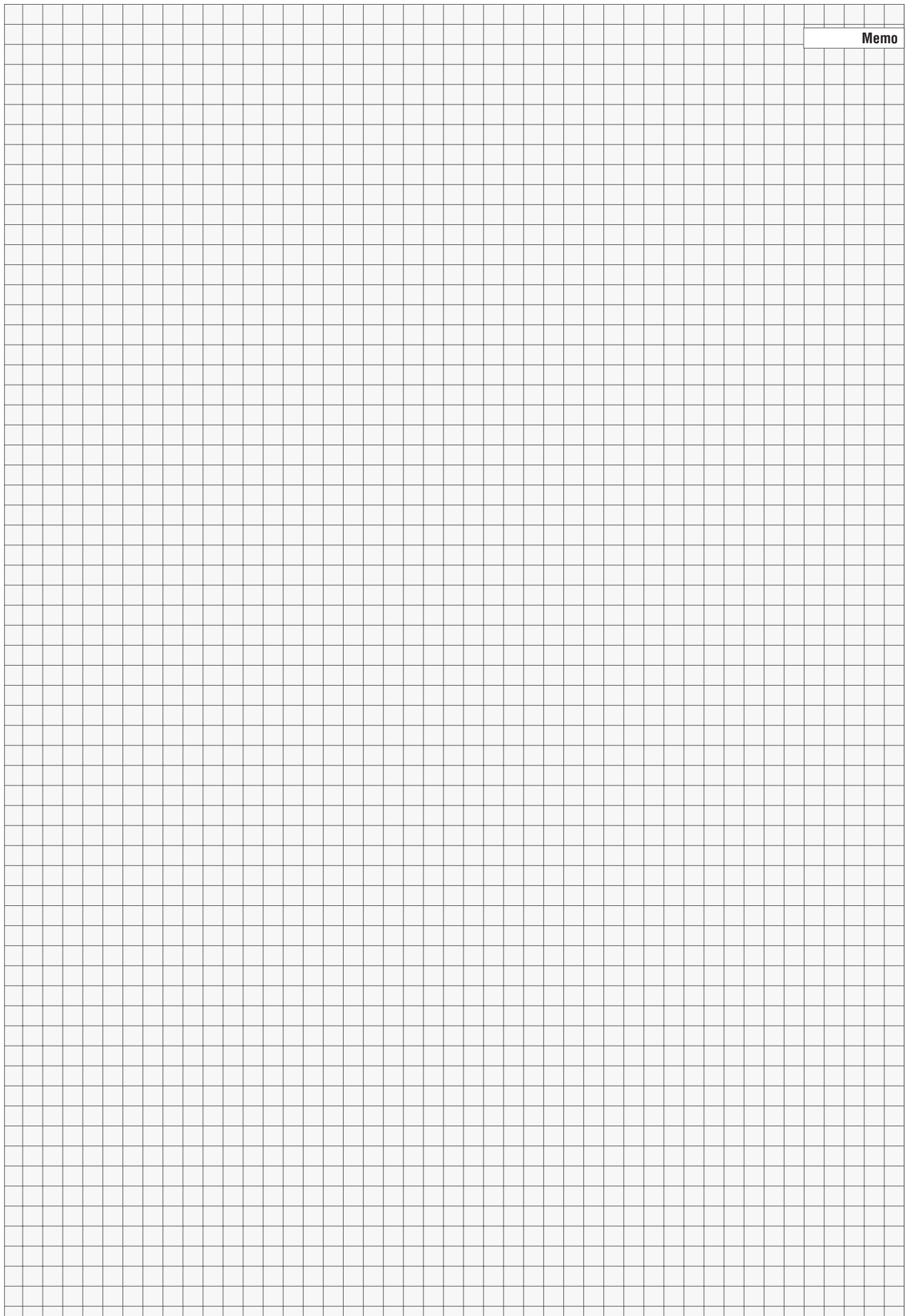

15

Pneumatic tools Narzędzia pneumatyczne



Impact wrenches
Klucze udarowe

252-255



Pneumatic accessories

Akcesoria instalacji pneumatycznej

261-263



Impact wrenches 1/2"

Klucze udarowe 1/2"..... 252

Impact wrenches 3/4"

Klucze udarowe 3/4"..... 254

Impact wrenches 1"

Klucze udarowe 1"..... 254

Air filters, regulators & lubricators

Filtry, reduktory i smarownice..... 261

Spiral hoses

Węże spiralne..... 262

Reinforced hoses

Węże zbrojone..... 262

Couplers

Złącza..... 262

Cordless impact wrenches & accessories

Akumulatorowe klucze udarowe i akcesoria

255-256



Air grease guns

Smarownice pneumatyczne

264



Impact wrenches 1/2"

Klucze udarowe 1/2"..... 255

Accessories

Akcesoria..... 256

Pneumatic riveters

Nitownice pneumatyczne

264



Other air tools

Inne narzędzia pneumatyczne

256-259



Pneumatic stitching & nailing machines

Zszywacze i gwoździarki pneumatyczne

265



Pneumatic ratchets & sets

Grzechotki pneumatyczne i zestawy..... 256

Pneumatic grinders & accessories

Szlifierki pneumatyczne i akcesoria..... 256

Pneumatic cut-off tools & discs

Przecinarki pneumatyczne i tarcze..... 258

Pneumatic shears

Nożyce pneumatyczne..... 258

Pneumatic drills

Wiertarki pneumatyczne..... 258

Pneumatic hammers

Młotki pneumatyczne..... 259

Holders for tools

Uchwyty na narzędzia..... 259

Tire inflating guns & heads

Pistolety do pompowania kół i głowice..... 259

Painting equipment & accessories

Narzędzia do malowania i akcesoria

260-261



Spray guns

Pistolety lakiernicze..... 260

Inflating guns

Pistolety do przedmuchiwania..... 260

Washing guns

Pistolety do ropowania..... 260

Air sand blasters

Pistolety do piaskowania..... 260

Work benches

Stojaki lakiernicze..... 261

GB Impact wrench
D Druckluft-Schlagschrauber
PL Klucz pneumatyczny
RUS Ударный пневматический гайковерт
CZ Klúč pneumatický
H Pneumatikus ütvecsavarozó
RO Pistol pneumatic
F Clé à choc pneumatique
I Chiave ad impulsi pneumatica
E Llave neumática de percusión
CN 气动扳手

COLOR BOX



1/2"	TWIN HAMMER TYPE	0.63 MPa
12.5mm		
119 l/min	550 Nm	7500 min ⁻¹
STANDARD		



TWIN HAMMER™
 mechanism ensuring resilience to damage and overload

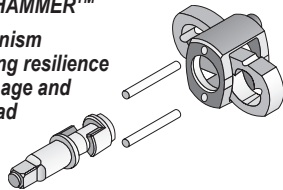

$L_{pa} = 92 \pm 3$ dB;
 $L_{pk} = 103 \pm 3$ dB;
 $a_p = 5,47 \pm 1,5$ m/s²

YATO	Nm	
YT-09511	550	8

GB Impact wrench
D Druckluft-Schlagschrauber
PL Klucz pneumatyczny
RUS Ударный пневматический гайковерт
CZ Klúč pneumatický
H Pneumatikus ütvecsavarozó
RO Pistol pneumatic
F Clé à choc pneumatique
I Chiave ad impulsi pneumatica
E Llave neumática de percusión
CN 气动扳手

COLOR BOX



1/2"	TWIN HAMMER TYPE	0.63 MPa
12.5mm		
142 l/min	570 Nm	10000 min ⁻¹
COMPOSITE BODY KOMPOZITONIA GÖZTÖRŐ STANDARD		



TWIN HAMMER™
 mechanism ensuring resilience to damage and overload

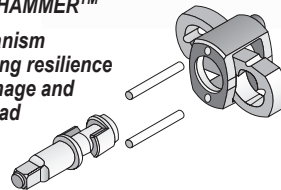

$L_{pa} = 90,7 \pm 3,0$ dB;
 $L_{pk} = 101,7 \pm 3,0$ dB;
 $a_p = 3,0 \pm 1,5$ m/s²

YATO	Nm	
YT-09505	570	10

GB Impact wrench
D Druckluft-Schlagschrauber
PL Klucz pneumatyczny
RUS Ударный пневматический гайковерт
CZ Klúč pneumatický
H Pneumatikus ütvecsavarozó
RO Pistol pneumatic
F Clé à choc pneumatique
I Chiave ad impulsi pneumatica
E Llave neumática de percusión
CN 气动扳手

COLOR BOX



1/2"	SINGLE HAMMER TYPE	0.63 MPa
12.5mm		
100 l/min	678 Nm	10000 min ⁻¹
STANDARD		



SINGLE HAMMER
 mechanism ensuring resilience to damage and overload

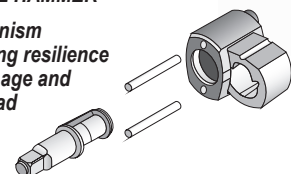

$L_{pa} = 97,4 \pm 3,0$ dB;
 $L_{pk} = 103,0 \pm 3,0$ dB;
 $a_p = 7,3 \pm 1,21$ m/s²

YATO	Nm	
YT-09512	678	10

GB Impact wrench
D Druckluft-Schlagschrauber
PL Klucz pneumatyczny
RUS Ударный пневматический гайковерт
CZ Klúč pneumatický
H Pneumatikus ütvecsavarozó
RO Pistol pneumatic
F Clé à choc pneumatique
I Chiave ad impulsi pneumatica
E Llave neumática de percusión
CN 气动扳手

COLOR BOX



1/2"	TWIN HAMMER TYPE	0.63 MPa
12.5mm		
165 l/min	680 Nm	10000 min ⁻¹
STANDARD		



TWIN HAMMER™
 mechanism ensuring resilience to damage and overload

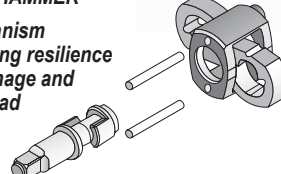



$L_{pa} = 94,0 \pm 3,0$ dB;
 $L_{pk} = 105,0 \pm 3,0$ dB;
 $a_p = 9,0 \pm 0,4$ m/s²

YATO	Nm	
YT-09513	680	10

GB Impact wrench
D Druckluft-Schlagschrauber
PL Klucz pneumatyczny
RUS Ударный пневматический гайковерт
CZ Klíč pneumatický
H Pneumatikus ütvecsavarozó
RO Pistol pneumatic
F Clé à choc pneumatique
I Chiave ad impulsi pneumatica
E Llave neumática de percusión
CN 气动扳手

COLOR BOX



1/2" 12.5mm	TWIN HAMMER TYPE	0.63 MPa
184 l/min	680 Nm	7000 ^{max} min ⁻¹
 COMPOSITE BODY  STANDARD		



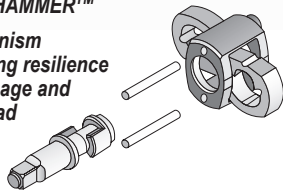

TWIN HAMMER™

mechanism ensuring resilience to damage and overload





$L_{pA} = 95,0 \pm 3,0$ dB;
 $L_{wA} = 106,0 \pm 3,0$ dB;
 $a_s = 9,1 \pm 1,5$ m/s²

YATO 	Nm	
YT-09524	680	5

GB Impact wrench
D Druckluft-Schlagschrauber
PL Klucz pneumatyczny
RUS Ударный пневматический гайковерт
CZ Klíč pneumatický
H Pneumatikus ütvecsavarozó
RO Pistol pneumatic
F Clé à choc pneumatique
I Chiave ad impulsi pneumatica
E Llave neumática de percusión
CN 气动扳手

COLOR BOX



1/2" 12.5mm	TWIN HAMMER TYPE	0.6-0.8 MPa
119 l/min	850 Nm	7000 ^{max} min ⁻¹
 COMPOSITE BODY  STANDARD		



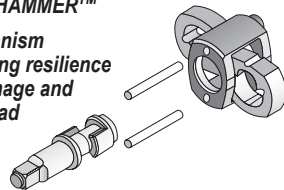

TWIN HAMMER™

mechanism ensuring resilience to damage and overload





$L_{pA} = 92 \pm 3$ dB;
 $L_{wA} = 103 \pm 3$ dB;
 $a_s = 5,47 \pm 1,5$ m/s²

YATO 	Nm	
YT-09525	850	6

GB Impact wrench
D Druckluft-Schlagschrauber
PL Klucz pneumatyczny
RUS Ударный пневматический гайковерт
CZ Klíč pneumatický
H Pneumatikus ütvecsavarozó
RO Pistol pneumatic
F Clé à choc pneumatique
I Chiave ad impulsi pneumatica
E Llave neumática de percusión
CN 气动扳手

COLOR BOX



1/2" 12.5mm	TWIN HAMMER TYPE	0.63 MPa
153 l/min	1356 Nm	10000 min ⁻¹
 COMPOSITE BODY  STANDARD		



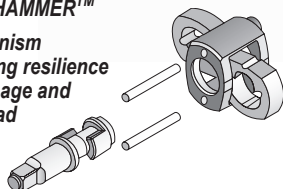

TWIN HAMMER™

mechanism ensuring resilience to damage and overload





$L_{pA} = 93,7 \pm 3,1$ dB;
 $L_{wA} = 104,7 \pm 3,1$ dB;
 $a_s = 4,4 \pm 0,4$ m/s²

YATO 	Nm	
YT-0953	1356	10

GB Impact wrench
D Druckluft-Schlagschrauber
PL Klucz pneumatyczny
RUS Ударный пневматический гайковерт
CZ Klíč pneumatický
H Pneumatikus ütvecsavarozó
RO Pistol pneumatic
F Clé à choc pneumatique
I Chiave ad impulsi pneumatica
E Llave neumática de percusión
CN 气动扳手

COLOR BOX



1/2" 12.5mm	TWIN HAMMER TYPE	0.63 MPa
153 l/min	1150 Nm	10000 min ⁻¹
 COMPOSITE BODY  STANDARD		



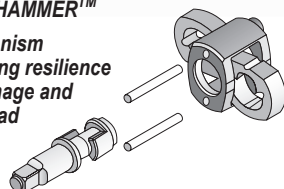

TWIN HAMMER™

mechanism ensuring resilience to damage and overload



$L_{pA} = 93,7 \pm 3,1$ dB;
 $L_{wA} = 104,7 \pm 3,1$ dB;
 $a_s = 4,4 \pm 0,4$ m/s²

YATO 	Nm	
YT-09540	1150	10

GB Impact wrench
D Druckluft-Schlagschrauber
PL Klucz pneumatyczny
RUS Ударный пневматический гайковерт
CZ Klíč pneumatický
H Pneumatikus ütvecsavarozó
RO Pistol pneumatic
F Clé à choc pneumatique
I Chiave ad impulsi pneumatica
E Llave neumática de percusión
CN 气动扳手

COLOR BOX



3/4" 19 mm	TWIN HAMMER TYPE	0.63 MPa
660 l/min	1300 Nm	5000 min⁻¹
		3/8" 10 mm



TWIN HAMMER™
 mechanism ensuring resilience to damage and overload

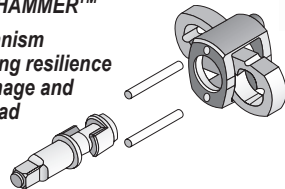

$L_{pa} = 92 \pm 3$ dB;
 $L_{pa} = 103 \pm 3$ dB;
 $a_p = 5,47 \pm 1,5$ m/s²

YATO	Nm	
YT-09564	1300	6

GB Impact wrench
D Druckluft-Schlagschrauber
PL Klucz pneumatyczny
RUS Ударный пневматический гайковерт
CZ Klíč pneumatický
H Pneumatikus ütvecsavarozó
RO Pistol pneumatic
F Clé à choc pneumatique
I Chiave ad impulsi pneumatica
E Llave neumática de percusión
CN 气动扳手

COLOR BOX



3/4" 19 mm	TWIN HAMMER TYPE	0.63 MPa
198 l/min	1630 Nm	5500 min⁻¹
		3/8" 10 mm



TWIN HAMMER™
 mechanism ensuring resilience to damage and overload

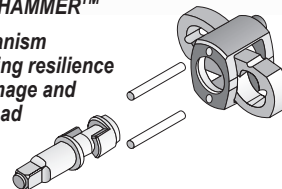

$L_{pa} = 100,6 \pm 3,0$ dB;
 $L_{pa} = 111,6 \pm 3,0$ dB;
 $a_p = 10,21 \pm 1,5$ m/s²

YATO	Nm	
YT-09571	1630	6

GB Pneumatic wrench
D Druckluft-Schlüssel
PL Klucz pneumatyczny
RUS Пневматический ключ
CZ Pneumatický utahovák
H Pneumatikus kulcs
RO Cheie pneumatica

F Clé à choc pneumatique
I Chiave ad impulsi pneumatica
E Llave neumática
CN 气动扳手

PINLESS HAMMER™
 closed hammer cage mechanism prevents breakage from hammer pin damage



- application: automotive service stations, trucks
- strong, uniform impact
- przeznaczenie: serwis, samochody ciężarowe
- silny, jednolity uder



$L_{pa} = 94,1 \pm 2,8$ dB;
 $L_{pa} = 104,8 \pm 2,8$ dB;
 $a_p = 14,53 \pm 1,93$ m/s²

YATO	Nm	
YT-0959	2600	2

GB Pneumatic wrench
D Druckluft-Schlüssel
PL Klucz pneumatyczny
RUS Пневматический ключ
CZ Pneumatický utahovák
H Pneumatikus kulcs

RO Cheie pneumatica
F Clé à choc pneumatique
I Chiave ad impulsi pneumatica
E Llave neumática
CN 气动扳手

PINLESS HAMMER™
 closed hammer cage mechanism prevents breakage from hammer pin damage



- application: automotive service stations, trucks
- strong, uniform impact
- przeznaczenie: serwis, samochody ciężarowe
- silny, jednolity uder



$L_{pa} = 97,2 \pm 2,0$ dB;
 $L_{pa} = 107,7 \pm 2,8$ dB;
 $a_p = 23,28 \pm 4,76$ m/s²

YATO	Nm	
YT-0960	2600	2

- GB Pneumatic wrench
- D Druckluft-Schlüssel
- PL Klucz pneumatyczny
- RUS Пневматический ключ
- CZ Pneumatický utahovák
- H Pneumatikus kulcs
- RO Cheie pneumatica
- F Clé à choc pneumatique
- I Chiave ad impulsi pneumatica
- E Llave neumática
- CN 气动扳手



COLOR BOX





1" 25 mm	TWIN HAMMER TYPE	0.63 MPa	255 l/min
	8.3 kg ULTRA LIGHT	2700 Nm	4800 min ⁻¹
	STANDARD	1/2" 12.5 mm	
COMPOSITE BODY KOMPOZYTOWA OBUDOWA			



- application: industry, service stations, tire service stations, truck service
- the lightest 1" impact wrench with torque of 2700 Nm
- magnesium alloy and composite housing
- low vibration
- low air consumption

- przeznaczenie: przemysł, serwisy mobilne i stacjonarne, serwisy opon oraz pojazdów ciężarowych
- najlżejszy klucz pneumatyczny w klasie 1" o mocy 2700 Nm
- obudowa ze stopów magnezu i kompozytu
- niski poziom wibracji
- małe zużycie powietrza

$L_{pa} = 93.6 \pm 3.0$ dB;
 $L_{wa} = 104.6 \pm 3.0$ dB;
 $a_p = 5.0 \pm 1.5 / 8.6 \pm 1.5$ m/s²

YATO 	Nm	
YT-09611	2700	2

- GB Pneumatic wrench
- D Druckluft-Schlüssel
- PL Klucz pneumatyczny
- RUS Пневматический ключ
- CZ Pneumatický utahovák
- H Pneumatikus kulcs
- RO Cheie pneumatica
- F Clé à choc pneumatique
- I Chiave ad impulsi pneumatica
- E Llave neumática
- CN 气动扳手



PINLESS HAMMER™

closed hammer cage mechanism prevents breakage from hammer pin damage





BMC
& COLOR
SLEEVE



$L_{pa} = 97.1 \pm 3.0$ dB;
 $L_{wa} = 108.1 \pm 3.0$ dB;
 $a_p = 13.750 \pm 1.5$ m/s²

1" 25 mm	PINLESS HAMMER TYPE	0.6-1 MPa	355 l/min
	3200 Nm	3500 min ⁻¹	
	STANDARD	1/2"	

YATO 	Nm	
YT-09615	3200	1

- GB Cordless impact wrench
- D Akku-schlagschrauber
- PL Akumulatorowy klucz udarowy
- RUS Аккумуляторный ударный гайковерт
- CZ Akumulátorový rázový utahovák
- H Akkus ütvecsavarozó
- RO Pistol impact cu acumulator
- F Clé a choc sans fil
- I Chiave ad impulsi con chiavi a bussola esagonale
- E Inalámbrico llave de impacto
- CN 气动棘轮扳手

1/2" 12.5 mm	280 Nm	18 V	0-2200 min ⁻¹	0-3300 mm	Li-Ion
	3000 mAh	2h QUICK CHARGING Szybkie Ładowanie	LED BATTERY INDICATOR Wskaznik Napięcia Akumulatora	17,19 21,22 mm	



additional battery in set
dodatkowy akumulator
w zestawie

BMC
& COLOR
SLEEVE



YATO 	Nm	
YT-82930	280	3

- GB Cordless impact wrench
- D Akku-schlagschrauber
- PL Akumulatorowy klucz udarowy
- RUS Аккумуляторный ударный гайковерт
- CZ Akumulátorový rázový utahovák
- H Akkus ütvecsavarozó
- RO Pistol impact cu acumulator
- F Clé a choc sans fil
- I Chiave ad impulsi con chiavi a bussola esagonale
- E Inalámbrico llave de impacto
- CN 气动棘轮扳手

1/2" 12.5 mm	280 Nm	18 V	0-2200 min ⁻¹	0-3300 mm	Li-Ion
	3000 mAh	2h QUICK CHARGING Szybkie Ładowanie	LED BATTERY INDICATOR Wskaznik Napięcia Akumulatora	17,19 21,22 mm	



BMC
& COLOR
SLEEVE



YATO 	Nm	
YT-82931	280	3

$L_{pa} = 87.5 \pm 3.0$ dB;
 $L_{wa} = 98.5 \pm 3.0$ dB;
 $a_p = 9.93 \pm 1.5$ m/s²

GB Battery
D Akkumulator
PL Akumulator
RUS Аккумулятор
CZ Akumulátor
H Akkumulátor

RO Acumulatorul
F Batterie
I Batteria
E Bateria
CN 锂电池



18 V
Li-Ion
3000 mAh
2h QUICK CHARGING SYSTEM LOCKING

WHITE CARTON BOX & COLOR LABEL

YATO	V	
YT-82932	18	20

for / dla: YT-82930, YT-82931

GB Ratchet air wrench
D Druckluft-Ratschenschrauber
PL Grzechotka pneumatyczna
RUS Пневмотрещотка
CZ Utahovák vzduchový
H Préslevegős behajtó szerszám

RO Antrenor pneumatic
F Clé à cliquet pneumatique
I Chiave a cricchetto pneumatica
E Carraca neumática
CN 气动棘轮扳手

1/2" 0.62 MPa
12.5mm
120 l/min 80 Nm
160 min⁻¹ STANDARD



YATO	Nm	
YT-0981	80	20

L_{pa} = 87,6 ± 1,9 dB;
L_{wa} = 97,7 ± 2,7 dB;
a₁ = 14,83 ± 1,96 m/s²

GB Ratchet air wrench
D Druckluft-Ratschenschrauber
PL Grzechotka pneumatyczna
RUS Пневмотрещотка
CZ Utahovák vzduchový
H Préslevegős behajtó szerszám

RO Antrenor pneumatic
F Clé à cliquet pneumatique
I Chiave a cricchetto pneumatica
E Carraca neumática
CN 气动棘轮扳手

1/2" 0.62 MPa
12.5mm
110 l/min 68 Nm
160 min⁻¹ STANDARD



YATO	Nm	
YT-0980	68	20

L_{pa} = 93,1 ± 1,9 dB;
L_{wa} = 104,4 ± 2,7 dB;
a₁ = 19,98 ± 2,47 m/s²

GB Ratchet wrench kit
D Druckluft-Ratschenschrauber mit Zubehör
PL Zestaw z grzechotką pneumatyczną
RUS Пневмотрещотка в наборе
CZ Klíč ráčnový pneumatický s příslušenstvím
H Pneumatikus racsniskulcs készlet
RO Cheie pneumatica cu accesorii
F Clé à cliquet pneumatique
I Chiave a cricchetto pneumatica
E Juego con carraca neumática
CN 气动棘轮扳手套

1/2" OILER POT 0.62 MPa 110 l/min
12.5mm
68 Nm 160 min⁻¹ CrV STANDARD



YATO	Nm	
YT-0982	68	4

L_{pa} = 93,1 ± 1,9 dB;
L_{wa} = 104,4 ± 2,7 dB;
a₁ = 19,98 ± 2,47 m/s²

1/2" (12.7 mm), L=75 mm;
6 mm x 1/2" (12.7 mm);
1/2" (12.7 mm);
H4, H5, H6, H7, H8;
T20, T25, T27, T30, T40;
5.5, 6.5, 8.0 mm;
PH2, PH3, PH4;
10, 11, 12, 13, 14, 17, 19 mm

BMC & COLOR SLEEVE

GB Air grinder
D Drucklufteinhandschleifer
PL Szlifierka pneumatyczna prosta
RUS Шлифмашинка пневматическая
CZ Bruska přímá pneumatická
H Pneumatikus egyenescsiszoló
RO Polizor pneumatic
F Mini ponceuse pneumatique
I Smerigliatrice dritta pneumatica
E Lijadora neumática recta
CN 气动修磨机

0.62 MPa 160 l/min
2000 min⁻¹ 3 6 mm STANDARD



YATO		
YT-0965	25	

L_{pa} = 100,7 ± 2,4 dB;
L_{wa} = 106,2 ± 3,7 dB;
a₁ = 2,83 ± 0,93 m/s²

GB Air grinder
D Drucklufteinhandschleifer
PL Szlifierka pneumatyczna prosta
RUS Шлифмашинка пневматическая
CZ Bruska přímá pneumatická
H Pneumatikus egyenescsiszoló
RO Polizor pneumatic
F Mini ponceuse pneumatique
I Smerigliatrice dritta pneumatica
E Lijadora neumática recta
CN 气动修磨机

0.63 MPa 113 l/min
25000 min⁻¹ 6 mm
COMPOSITE BODY KOMPLEKTYWNA OBUDOWA
REAR AIR EXHAUST CAN BE ROTATED 360°
MOŻLIWOŚĆ USTAWIENIA WYDMUCHU POWIETRZA O 360°



YATO		
YT-09632	20	

L_{pa} = 88,0 ± 3,0 dB;
L_{wa} = 99,0 ± 3,0 dB;
a₁ = 2,9 ± 1,5 m/s²

GB Pneumatic angle grinder
D Ruckluft-Winkelschleifer
PL Szlifierka kątowna pneumatyczna
RUS Пневматическая угловая шлифовальная машина
CZ Pneumatiké úhlovou brusku
H Pneumatikus sarokcsiszoló
RO Polizor unghiular pneumatic
F Pneumatique meuleuse d'angle
I Smerigliatrice angolare pneumatica
E Amoladora angular neumática
CN 气动角磨

0.63 MPa 141 l/min
11000 min⁻¹ 125mm 1625mm STANDARD



YATO		
YT-09675	8	

L_{pa} = 87 ± 3 dB;
L_{wa} = 98 ± 3 dB;
a₁ = 3,4 ± 1,5 m/s²

GB Air sander
D Druckluft-Excenterschleifer
PL Szlifierka pneumatyczna mimośrodowa
RUS Шлифмашинка эксцентриковая пневматическая
CZ Bruska pneumatická
H Pneumatikus polírozó
RO Masina de slefuit pneumatica
F Ponceuse pneumatique
I Smerigliatrice orbitale pneumatica
E Lijadora neumática excéntrica
CN 气动砂磨机

0.63 MPa
84 l/min
10500 min⁻¹
150 mm

ECCENTRIC
VACUUM SYSTEM
SYSTEM ODPYLANIA
STANDARD



$L_{pa} = 90 \pm 3$ dB;
 $L_{wa} = 101 \pm 3$ dB;
 $a_s = 4,4 \pm 2,5$ m/s²

YATO
YT-09740 10

GB Air sander
D Druckluft-Excenterschleifer
PL Szlifierka pneumatyczna mimośrodowa
RUS Шлифмашинка эксцентриковая пневматическая
CZ Bruska pneumatická
H Pneumatikus polírozó
RO Masina de slefuit pneumatica
F Ponceuse pneumatique
I Smerigliatrice orbitale pneumatica
E Lijadora neumática excéntrica
CN 气动砂磨机

0.62 MPa
230 l/min
9000 min⁻¹
150 mm

ECCENTRIC
STANDARD



$L_{pa} = 88,4 \pm 2,1$ dB;
 $L_{wa} = 96,2 \pm 3,0$ dB;
 $a_s = 3,81 \pm 0,87$ m/s²

YATO
YT-0967 10

GB Air belt sander
D Pneumatische Bandschleifer
PL Pneumatyczna szlifierka taśmowa
RUS Пневматический шлифовальный
CZ Pneumatická pásová bruska
H Pneumatikus szalagcsiszoló
RO Polizor pneumatic cu banda
F Ponceuse à bandes pneumatique
I Nastro per levigatrice pneumatica
E Lijadora de banda neumática
CN 气动砂带机



170 l/min
0.63 MPa
20000 min⁻¹
EASY BELT REPLACEMENT
LATWA WYMIANA PASA
STANDARD



includes belts: /
w zestawie pasy:
P60, P80, P120

$L_{pa} = 93 \pm 3$ dB;
 $L_{wa} = 104 \pm 3$ dB;
 $a_s = 4,8 \pm 1,5$ m/s²

YATO belt size / rozmiar pasa (mm)
YT-09741 10x330 10

GB Air belt sander
D Pneumatische Bandschleifer
PL Pneumatyczna szlifierka taśmowa
RUS Пневматический шлифовальный
CZ Pneumatická pásová bruska
H Pneumatikus szalagcsiszoló
RO Polizor pneumatic cu banda
F Ponceuse à bandes pneumatique
I Nastro per levigatrice pneumatica
E Lijadora de banda neumática
CN 气动砂带机



200 l/min
0.63 MPa
20000 min⁻¹
EASY BELT REPLACEMENT
LATWA WYMIANA PASA
STANDARD

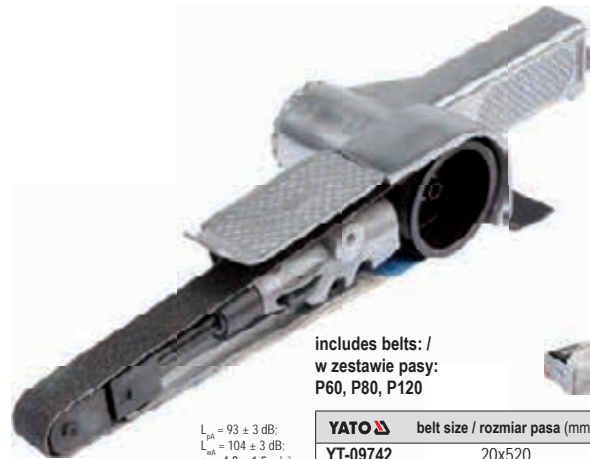

includes belts: /
w zestawie pasy:
P60, P80, P120

$L_{pa} = 93 \pm 3$ dB;
 $L_{wa} = 104 \pm 3$ dB;
 $a_s = 4,8 \pm 1,5$ m/s²

YATO belt size / rozmiar pasa (mm)
YT-09742 20x520 10

GB Endless sanding belt
D Schleifband
PL Taśma ścierna bezkońcowa
RUS Шлифовальные ленты
CZ Brusný pás
H Csiszoló szalag
RO Bandă de pânză
F Bande abrasive sans fin
I Nastro abrasivo senza fine
E Pano abrasivo cinturón
CN 砂带

- application: metal, wood
- abrasive: aluminium oxide
- bond: synthetic resin
- coating: close
- zastosowanie: metal, drewno
- ścierniwo: tlenek glinu
- spoiwo: żywica syntetyczna
- nasyp pełny



- application: metal, wood
- abrasive: aluminium oxide
- bond: synthetic resin
- coating: close
- zastosowanie: metal, drewno
- ścierniwo: tlenek glinu
- spoiwo: żywica syntetyczna
- nasyp pełny

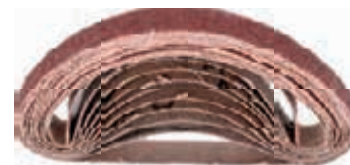

HANGING
COLOR BOX



YATO	grit / ziarnistość	size / rozmiar (mm)	PCS packing	
YT-09743	60	10x330	10	100
YT-09744	80	10x330	10	100
YT-09745	100	10x330	10	100
YT-09746	120	10x330	10	100

YATO	grit / ziarnistość	size / rozmiar (mm)	PCS packing	
YT-09747	60	20x520	10	50
YT-09748	80	20x520	10	50
YT-09749	100	20x520	10	50
YT-09750	120	20x520	10	50

GB Air cut-off tool
D Druckluft-Schneidmaschine
PL Przecinarka pneumatyczna
RUS Резак пневматический
CZ Příčná bruska pneumatická
H Pneumatikus sarokcsiszoló

RO Masina de taiat cu aer comprimat
F Coupeuse pneumatique
I Fresa pneumatica
E Cortadora neumática
CN 气动切割工具

0.62 MPa
480 l/min
18000 min⁻¹
 75mm
 9.4mm
 STANDARD



L_{pa} = 97,1 ± 2,4 dB;
 L_{wa} = 103,1 ± 3,6 dB;
 a_v = 1,54 ± 0,51 m/s²

COLOR BOX

YATO
YT-0993 20

GB Air cut-off tool
D Druckluft-Schneidmaschine
PL Przecinarka pneumatyczna
RUS Резак пневматический
CZ Příčná bruska pneumatická
H Pneumatikus sarokcsiszoló

RO Masina de taiat cu aer comprimat
F Coupeuse pneumatique
I Fresa pneumatica
E Cortadora neumática
CN 气动切割工具

0.63 MPa
127 l/min
20000 min⁻¹
 75mm
 9.5mm
 STANDARD



L_{pa} = 77,0 ± 3,0 dB;
 L_{wa} = 88,0 ± 3,0 dB;
 a_v = 2,38 ± 1,5 m/s²

COLOR BOX

YATO
YT-09715 10

GB Metal cutting disc
D Metall-Trennscheibe
PL Tarcza do cięcia metalu
RUS Круги отрезные по металлу
CZ Souprava kotoučů pro řezání kovu
H Vágókorong fémhez

RO Set de pânze de taiat metal
F Set de disques
I Disco per taglio metallo
E Disco cortador para metal
CN 金属切割片组套

5 PCS
75mm
2mm
9.5mm
18000 min⁻¹



BLISTER CARD

for / dla: YT-0993

YATO
YT-0994 12/48

GB Air shears pistol type
D Pneumatische Schere
PL Nożyce pneumatyczne kątowe
RUS Пневматические ножницы угловые
CZ Pneumatické nůžky na plech

H Pneumatikus ollók
RO Foarfeca pneumatica
F Cisailles pneumatiques
I Cesoia pneumatica angolare
E Tijera neumática
CN 气动剪刀

0.63 MPa
141 l/min
1800 min⁻¹
5.5mm
1.2 STEEL
1.4 AL



L_{pa} = 80 ± 3 dB;
 L_{wa} = 91 ± 3 dB;
 a_v = 6,5 ± 1,5 m/s²

COLOR BOX

YATO
YT-09944 10

GB Air shears
D Pneumatische Schere
PL Nożyce pneumatyczne proste
RUS Пневматические ножницы прямые
CZ Pneumatické nůžky na plech

H Pneumatikus ollók
RO Foarfeca pneumatica
F Cisailles pneumatiques
I Cesoia pneumatica dritta
E Tijera neumática
CN 气动剪刀

0.63 MPa
141 l/min
2500 min⁻¹
5.5mm
1.2 STEEL
1.4 AL
 STANDARD



L_{pa} = 90 ± 3 dB;
 L_{wa} = 101 ± 3 dB;
 a_v = 4,6 ± 1,5 m/s²

YATO
YT-09945 15

COLOR BOX

GB Reversible air drill
D Druckluft-Bohrmaschine mit Stahl-Zahnkranzfutter
PL Wiertarka pneumatyczna
RUS Пневматическая дрель
CZ Vrtačka ruční vzduchová
H Pneumatikus fűrő

RO Masina de gaurit pneumatica mandrina
F Perceuse pneumatique
I Fresa pneumatica
E Taladradora neumática
CN 双向气钻

0.62 MPa
180 l/min
0-1800 min⁻¹
10mm
 STANDARD



L_{pa} = 87,2 ± 1,4 dB;
 L_{wa} = 99,7 ± 2,9 dB;
 a_v = 3,88 ± 1,04 m/s²

COLOR BOX

YATO
YT-0970 20

- GB** Reversible air drill
D Druckluft-Bohrmaschine mit Stahl-Zahnkranzfutter
PL Wiertarka pneumatyczna
RUS Пневматическая дрель
CZ Vrtačka ruční vzduchová
H Pneumatikus fűrő

- RO** Masina de gaurit pneumatica mandrina
F Perceuse pneumatique
I Fresa pneumatica
E Taladradora neumática
CN 双向气钻

1.7 kg
0.63 MPa
198 l/min
700 min⁻¹
max. 10 mm
STANDARD



- GB** Air hammer
D Druckluft-Schlaghammer
PL Młotek pneumatyczny
RUS Зубило пневматическое
CZ Sekáč vzduchový
H Pneumatikus vésőkészlet pisztollyal

- RO** Ciosan cu aer comprimat
F Marteau pneumatique
I Martello pneumatica
E Martillo neumático
CN 气锤

0.62 MPa
113 l/min
3200 min⁻¹
STANDARD



- GB** Magnetic holder for tools
D Magnethalter für Schlagschrauber
PL Uchwyt magnetyczny na narzędzia
RUS Магнитный держатель для ударного гайковерта
CZ Magnetický držák nářadí
H Mágneses tartó
RO Suport magnetic pt. scule pneumatice
F Support magnétique pour outils pneumatiques
I Fissaggio magnetico per chiave ad impulsi pneumatica
E Soporte magnético para llave de impacto
CN 磁性喷枪架



- GB** Tire-inflating gun
D Reifenfüller
PL Pistolet do pompowania kół
RUS Пистолет для накачивания колёс
CZ Pistolet na čerpání z manometrem
H Gumiabroncs pumpáló
RO Pistol cu manometru pt. pompat
F Pistolet pour gonflage de pneus avec manomètre

- I** Pistola per gonfiaggio gomme
E Pistola de bombeo con manometro
CN 轮胎气压表

0.6 MPa (max.)
440mm HOSE WAZ
360°
STANDARD



- GB** Tire-inflating gun
D Reifenfüller
PL Pistolet do pompowania kół
RUS Пистолет для накачивания колёс
CZ Pistolet na čerpání z manometrem
H Gumiabroncs pumpáló
RO Pistol cu manometru pt. pompat
F Pistolet pour gonflage de pneus avec manomètre
I Pistola per gonfiaggio gomme
E Pistola de bombeo con manometro
CN 轮胎气压表



$L_{pA} = 89$ dB;
 $L_{wA} = 100$ dB;
 $a_p < 2.5$ m/s²

- GB** Inflating head
D Klemmnippel (universal)
PL Glowica do pompowania
RUS Универсальная головка
CZ Hlava na čerpání
H Pumpafej
RO Cap pt. pompat
F Mandrin de pompe
I Testa per il pompaggio
E Cabeza de bombeo
CN 充气头

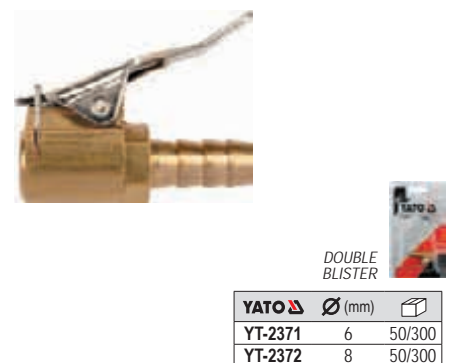

GB Spray gun with fluid cup
D Lackierpistole mit Fließbecher
PL Pistolet natryskowy
RUS Пистолет - распылитель с верхним бачком

CZ Pistole na lakování z nádrží
H Festékszóró pisztoly alsó- és felsőtartályos
RO Pistol de vopsit cu rezervor inferior
F Pistolet à peinture

I Pistola vernice
E Pistola de barniz
CN 喷枪

COLOR BOX



Ø 1.4 mm

410 l/min
 0.6 l
 0.30 MPa
 HVLP

L_{pa} = 74 dB;
 L_{wa} = 85 dB;
 a_w < 2.5 m/s²



Ø 1.5 mm

410 l/min
 0.6 l
 0.30 MPa
 HVLP

L_{pa} = 76 dB;
 L_{wa} = 87 dB;
 a_w < 2.5 m/s²



Ø 1.8 mm

380 l/min
 0.40 MPa
 1.0 l

L_{pa} = 79 dB;
 L_{wa} = 90 dB;
 a_w < 2.5 m/s²



Ø 0.8 mm

220 l/min
 0.1 l
 0.30 MPa
 HVLP

L_{pa} = 67 dB;
 L_{wa} = 78 dB;
 a_w < 2.5 m/s²

YATO
 YT-2340 20

YATO
 YT-2341 20

YATO
 YT-2346 10

YATO
 YT-2357 20

GB Inflating gun with extension
D Gebläsepistole mit Verlängerung
PL Pistolet do przedmuchiwania z przedłużką
RUS Пистолет для продувки с удлинителем
CZ Pistole na profukování dlouhá
H Rövid előfűvő pisztoly
RO Pistol lung pt. suflat
F Pistolet pour purger
I Pistola professionale
E Pistola de soplado
CN 长杆充气枪

1/4" 6.3mm

0.8 MPa (max.)

AI



SLIDING CARD



L_{pa} = 91 dB;
 L_{wa} = 102 dB;
 a_w < 2.5 m/s²

YATO
 YT-2373 20/40

GB Inflating gun with extension
D Gebläsepistole mit Verlängerung
PL Pistolet do przedmuchiwania z przedłużką
RUS Пистолет для продувки с удлинителем
CZ Pistole na profukování dlouhá
H Rövid előfűvő pisztoly
RO Pistol lung pt. suflat
F Pistolet pour purger
I Pistola professionale
E Pistola de soplado
CN 长杆充气枪

0.8 MPa (max.)

BRASS MOSIADZ

PP



SLIDING CARD

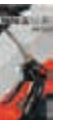

L_{pa} = 89 dB;
 L_{wa} = 100 dB;
 a_w < 2.5 m/s²

YATO
 YT-23731 20/40

GB Washing gun
D Waschpistole
PL Pistolet do ropowania
RUS Пистолет для нефтывания
CZ Pistole na ropování + nádrž
H Olajzópisztoly + tartály

RO Pistol (dozator) cu rezervor pt. motorină
F Pistolet à l'huile
I Pistola di lavaggio con nafta
E Pistola de petrolear
CN 喷水枪

0.85 l

130 l/min

AI

0.80 MPa



COLOR BOX



L_{pa} = 92 dB;
 L_{wa} = 103 dB;
 a_w < 2.5 m/s²

YATO
 YT-2374 2/12

GB Air sand blaster
D Pistole zum Sandstrahlen
PL Pistolet do piaskowania z wężem
RUS Пескоструйный пистолет
CZ Pískovací pistole s hadicí
H Homokszóró pisztoly tömlővel
RO Pistol de sablat

F Pistolet de sablage avec tuyau
I Pistola sabbiatrica
E Pistola para limpieza con chorro de arena con manguera
CN 吹气枪

1/4" 6.3mm

Ø 6.3mm

1m HOSE WAZ

AI



SLIDING CARD

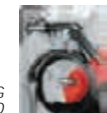

L_{pa} = 90 dB;
 L_{wa} = 101 dB;
 a_w < 2.03 m/s²

YATO
 YT-2375 10

- GB** Gun suitable for sand-blasting
D Sandstrahlpistole
PL Pistolet do piaskowania ze zbiornikiem
RUS Пескоструйный пистолет
CZ Pískovací pistole se zásobníkem
H Homokszórő pisztoly tartállyal
RO Pistol de sablat
F Pistolet de sablage avec réservoir
I Pistola sabbatrice con serbatoio
E Pistola para limpieza con chorro de arena con recip
CN 喷枪



1.0l
160 l/min
0.80 MPa
AI

COLOR BOX

YATO
YT-2376 20

L_{pa} = 91 dB;
L_{max} = 102 dB;
a₀ = < 2,03 m/s²

- GB** Work bench
D Lackierständer, verstellbar
PL Stojak lakierniczy rozstawny
RUS Раздвижная лакировочная стойка
CZ Stojan lakýrnický rozkládací
H Kinyitható lakkozó állvány
RO Suport extensibil pt. lacuit
F Support à peindre
I Supporto pieghevole
E Montante plegable para barnizar
CN 工作台



10 kg max
50 cm
85 cm
150 kg max
100 cm
45 cm

COLOR BOX

YATO
YT-5555 1

- GB** Mini filter
D Filter
PL Filtr
RUS Мини-фильтр
CZ Filtr
H Szűrő
RO Minifiltru
F Vidange mini
I Filtro
E Filtro
CN 微型过滤器



1.4 MPa (max.)
8 cm³
1/4"
6.3mm

COLOR BOX

YATO
YT-2380 25/50

- GB** Pressure reducing valve with manometer
D Druckminderer mit Manometer
PL Reduktor ciśnienia z manometrem
RUS Клапан уменьшения давления с манометром
CZ Redukční ventil s manometrem
H Nyomáscsökkentő szelep nyomásmérővel
RO Valva cu reductiepresiune + manometru
F Réducteur avec manomètre
I Regolatore di pressione con manometro
E Reductor + manometro
CN 带表调压减压阀



1.2 MPa (max.)
1/4"
6.3mm

COLOR BOX

YATO
YT-2381 25/50

- GB** Filter - reducer
D Druckfilter - Druckminderer
PL Filtr - reduktor
RUS Фильтр - редуктор
CZ Filtr derukční ventil
H Szűrő - nyomásszabályzó
RO Filtru cu reductor
F Réducteur avec filtre et manomètre
I Filtro regolatore
E Reductor + filtro
CN 过滤器



0.93 MPa (max.)
15 cm³
60°C max.
1/4"
6.3mm

COLOR BOX

YATO
YT-2382 25/50

- GB** Filter - reducer
D Druckfilter - Druckminderer
PL Filtr - reduktor
RUS Фильтр - редуктор
CZ Filtr derukční ventil
H Szűrő - nyomásszabályzó
RO Filtru cu reductor
F Réducteur avec filtre et manomètre
I Filtro regolatore
E Reductor + filtro
CN 过滤器



0.93 MPa (max.)
90 cm³
60°C max.
1/2"
12.5mm

COLOR BOX

YATO
YT-2383 25/50

- GB** Air filter regulator and lubricator
D Druckfilter - Druckminderer + Entöler
PL Zespół filtrujący reduktor + smarownica
RUS Фильтр-редуктор
CZ Redukční ventil s odlučovačem oleje
H Levegőelőkészítő
RO Filtru cu reductor
F Filtre régulateur lubrificateur pour air comprimé
I Filtro regolatore lubrificatore
E Juego de filtro reductor + engrasador
CN 气动三联件



0.93 MPa (max.)
25 cm³ FILTER FILTER
15 cm³ LUBRICANT CUP SMAROWNICA
60°C max.
1/4"
6.3mm

COLOR BOX

YATO
YT-2384 25/50

- GB** Air filter regulator and lubricator
D Druckfilter - Druckminderer + Entöler
PL Zespół filtrujący reduktor + smarownica
RUS Фильтр-редуктор
CZ Redukční ventil s odlučovačem oleje
H Levegőelőkészítő
RO Filtru cu reductor
F Filtre régulateur lubrificateur pour air comprimé
I Filtro regolatore lubrificatore
E Juego de filtro reductor + engrasador
CN 气动三联件



0.93 MPa (max.)
90 cm³ FILTER FILTER
60 cm³ LUBRICANT CUP SMAROWNICA
60°C max.
1/4"
6.3mm

COLOR BOX

YATO
YT-2385 25

- GB Spiral tube with quick coupling
- D Spiralschlauch mit Schnellkupplung
- PL Waż spiralny z szybkozłączem
- RUS Шланг спиральный с быстрым соединением
- CZ Spirálová vzduchová hadice
- H Levegős spiráltömlő gyorscsatlakozóval
- RO Tub spiralat cu, cuplare rapida
- F Tuyau spirale en polyurethane
- I Tubo a spirale con rapido
- E Manguera espiral
- CN PU气管



PU **1.2 MPa (max)** **STANDARD**

YATO	Ø (mm)	L (mm)	
YT-24201	5.5x8	5	50
YT-24202	5.5x8	10	25
YT-24203	5.5x8	15	25
YT-24204	6.5x10	5	50
YT-24205	6.5x10	10	25
YT-24206	6.5x10	15	25
YT-24207	8x12	5	50
YT-24208	8x12	10	25
YT-24209	8x12	15	20

- GB Air hose with quick coupler
- D Luftschlauch mit Schnellkupplung
- PL Waż techniczny zbrojony z szybkozłączami
- RUS Шланг пневматический с быстроразъемным соединением
- CZ Hadice vzduchová s rychlospojками
- H Levegőtömlő apa csatlakozóval
- RO Furtun aer comprimat cuple rapide
- F Le tuyau d'air avec raccords rapides
- I Rinforzato tecnico tubo flessibile con rapido
- E Manguera de aire del con los acopladores rápidos
- CN PVC气管



PVC **2.0 MPa (max)** **STANDARD**

YATO	Ø (mm)	L (mm)	
YT-24220	8	10	10
YT-24221	8	20	8
YT-24224	10	10	10
YT-24225	10	20	8

- GB Air hose reel
- D Luftschlauch am Haspel
- PL Waż pneumatyczny na zwijaku
- RUS Шланг пневматический на катушке
- CZ Naviják se vzduchovou hadicí
- H Levegőtömlő dob es
- RO Furtun de aer tumbur
- F Bobine de tuyau d'air et de
- I Tubo pneumatico sull'avvolgitore
- E Carrete de manguera de aire
- CN 气动软管卷盘



15m **10mm** **2.0 MPa (max)**
PVC **STANDARD**

EASILY MOUNTS TO WORKBENCH OR WALL
ŁATWY MONTAŻ DO STÓLU ROBOCZEGO LUB ŚCIANY

INCLUDES 4 ANCHORS
ZAWIERA 4 KOTWY



YATO	
YT-24240	2

COLOR BOX



- GB Quick coupler
- D Schnellkupplung
- PL Szybkozłącze
- RUS Быстрое соединение
- CZ Rychlospojka
- H Gyorscsatlakozó
- RO Mufa rapida pt. pistol pneumatic
- F Raccord rapide
- I Attacco rapido
- E Conexión de la entrada de aire
- CN 快速接头

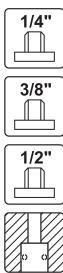

YATO	size / rozmiar	
YT-2390	1/4" (6.3 mm)	50/250
YT-2391	3/8" (10.0 mm)	50/250
YT-2392	1/2" (12.5 mm)	50/250

YATO	size / rozmiar	
YT-2393	1/4" (6.3 mm)	50/250
YT-2394	3/8" (10.0 mm)	50/250
YT-2395	1/2" (12.5 mm)	50/250

YATO	size / rozmiar	
YT-2396	1/4" (6.3 mm)	50/250
YT-2397	3/8" (10.0 mm)	50/250
YT-2398	1/2" (12.5 mm)	50/250

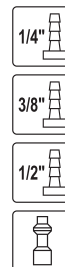
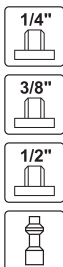

YATO	size / rozmiar	
YT-2399	1/4" (6.3 mm)	50/250
YT-2401	3/8" (10.0 mm)	50/250
YT-2402	1/2" (12.5 mm)	50/250

YATO	size / rozmiar	
YT-2403	1/4" (6.3 mm)	50/250
YT-2404	3/8" (10.0 mm)	50/250

YATO	size / rozmiar	
YT-2405	1/4" (6.3 mm)	50/250
YT-2406	3/8" (10.0 mm)	50/250
YT-2407	1/2" (12.5 mm)	50/250

GB Quick coupler
D Schnellkupplung
PL Szybkozłącze
RUS Быстрое соединение
CZ Rychlospojka
H Gyorscsatlakozó
RO Mufa rapida
pt. pistol pneumatic

F Raccord rapide
I Attacco rapido
E Conexión de la entrada de aire
CN 快速接头

2 PCS

 STANDARD



YATO
YT-24100 6/60

GB Quick coupler
D Schnellkupplung
PL Szybkozłącze
RUS Быстрое соединение
CZ Rychlospojka
H Gyorscsatlakozó
RO Mufa rapida
pt. pistol pneumatic

F Raccord rapide
I Attacco rapido
E Conexión de la entrada de aire
CN 快速接头

2 PCS

 STANDARD



YATO
YT-24101 6/60

GB Quick coupler
D Schnellkupplung
PL Szybkozłącze
RUS Быстрое соединение
CZ Rychlospojka
H Gyorscsatlakozó
RO Mufa rapida
pt. pistol pneumatic

F Raccord rapide
I Attacco rapido
E Conexión de la entrada de aire
CN 快速接头

2 PCS

 STANDARD



YATO
YT-24102 6/60

GB Quick coupler
D Schnellkupplung
PL Szybkozłącze
RUS Быстрое соединение
CZ Rychlospojka
H Gyorscsatlakozó
RO Mufa rapida
pt. pistol pneumatic





F Raccord rapide
I Attacco rapido
E Conexión de la entrada de aire
CN 快速接头

2 PCS

 STANDARD



YATO
YT-24103 6/60





GB 2 way quick coupler
D Zwei-wege schnellkupplung
PL Szybkozłącze podwójne
RUS Двусторонняя быстроразъемные соединения
CZ Two-way rychlospojky
H Levegőelosztó kettős gyorscsatlakozó
RO Distribuitoare cuple rapide
F Dérivation type y en cuivre
I Raccordo ottone con vie
E Conexión de la manguera de aire pase de acoplamiento rápido
CN 三通万用插嘴





BRASS
MOSIADZ



YATO
YT-24091 25/50





GB Quick coupler
D Schnellkupplung
PL Szybkozłącze
RUS Быстрое соединение
CZ Rychlospojka
H Gyorscsatlakozó
RO Mufa rapida pt. pistol pneumatic
F Raccord rapide
I Attacco rapido
E Conexión de la entrada de aire
CN 快速接头





BRASS
MOSIADZ



YATO
YT-24092 50/100

GB Quick coupler
D Schnellkupplung
PL Szybkozłącze
RUS Быстрое соединение
CZ Rychlospojka
H Gyorscsatlakozó
RO Mufa rapida pt. pistol pneumatic
F Raccord rapide
I Attacco rapido
E Conexión de la entrada de aire
CN 快速接头







BRASS
MOSIADZ



YATO
YT-24093 50/100

GB Quick coupler
D Schnellkupplung
PL Szybkozłącze
RUS Быстрое соединение
CZ Rychlospojka
H Gyorscsatlakozó

RO Mufa rapida
pt. pistol pneumatic
F Raccord rapide
I Attacco rapido
E Conexión de la entrada de aire
CN 快速接头







BRASS
MOSIADZ



YATO
YT-24094 50/100

GB Quick coupler
D Schnellkupplung
PL Szybkozłącze
RUS Быстрое соединение
CZ Rychlospojka
H Gyorscsatlakozó

RO Mufa rapida
pt. pistol pneumatic
F Raccord rapide
I Attacco rapido
E Conexión de la entrada de aire
CN 快速接头



BRASS
MOSIADZ



YATO
YT-24095 50/100

- GB** Air grease gun
D Druckluft-Fettpresse
PL Smarownica pneumatyczna
RUS Шприц для нагнетания густой смазки пневматический
CZ Mazací lis pneumatický

- H** Pneumatikus zsírózó
RO Pistol pt. gresat pneumatic
F Pistolet de graissage pneumatique
I Pneumatica per ingrassaggio
E Pistola engrasadora neumática
CN 气动黄油枪

400 cm³

28 l/min

STANDARD

OUT: 30-40 MPa



IN: 0.2-0.8 MPa

COLOR BOX

L_{pa} = 93 ± 3 dB;
 L_{wa} = 104 ± 3 dB;
 a_s = ≤ 2,5 m/s²

YATO	
YT-07055	10

- GB** Pneumatic grease injector
D Druckluft-Fettpresse
PL Towotnica/smarownica pneumatyczna
RUS Пневматический нагнетатель смазки
CZ Pneumatické čerpadlo maziv
H Pneumatikus zsír szivattyú
RO Pompa de unsoare pneumatice
F Pompe a graisse pneumatique
I Pneumatica per ingrassaggio
E Bomba de engrase neumática lubricar
CN 注油器

12 l

0.6-0.8 MPa

40 MPa (max)

4 m HOSE WAZ

50:1 RATIO SPREZANJE

STANDARD



GREY CARTON BOX & COLOR LABEL

L_{pa} = 97 ± 3 dB;
 L_{wa} = 108 ± 3 dB

YATO	
YT-07067	1

- GB** Pneumatic riveting machine
D Pneumatische Nietvorrichtung
PL Nitownica pneumatyczna
RUS Пневматический заклепочник
CZ Pneumatická nýtovačka
H Pneumatikus popszegecsűző

- RO** Presa pneumatica de nituri
F Riveuse pneumatique
I Rivettatrice pneumatica
E Máquina remachadora
CN 气动拉铆枪

STAINLESS STEEL, STEEL, ALUMINIUM, STAL, NIERDZEWNIA, STAL, ALUMINIUM

0.70 MPa

180° 1/4" 6.3mm

54 l/min

x3

x3



L_{pa} = 83.6 ± 1.9 dB;
 L_{wa} = 97.4 ± 2.8 dB;
 a_s = 0.66 ± 0.21 m/s²

COLOR BOX

YATO	Ø (mm)	L (mm)	F (kg)	F (N)	
YT-36171	2.4; 3.2; 4.0; 4.8; 5.0	18	1060	10400	10

- GB** Pneumatic riveting machine
D Pneumatische Nietvorrichtung
PL Nitownica pneumatyczna
RUS Пневматический заклепочник
CZ Pneumatická nýtovačka
H Pneumatikus popszegecsűző

- RO** Presa pneumatica de nituri
F Riveuse pneumatique
I Rivettatrice pneumatica
E Máquina remachadora
CN 气动拉铆枪

STAINLESS STEEL, ALUMINIUM, STAL, NIERDZEWNIA, STAL, ALUMINIUM

0.62 MPa

x5



• application: industry
 • przeznaczenie: przemysł

L_{pa} = 81.2 ± 3.0 dB;
 L_{wa} = 92.1 ± 3.0 dB;
 a_s = 0.6 ± 0.56 m/s²

COLOR BOX

YATO	Ø (mm)	L (mm)	F (kg)	F (N)	
YT-3618	2.4; 3.2; 4.0; 4.8; 6.4	16	1389	13620	6

GB Pneumatic stitching machine
D Drucklufthefter
PL Zszywacz pneumatyczny
RUS Пневматический шиватель
CZ Pneumatická sešivačka
H Pneumatikus tűzőgép

RO Capsator pneumatic
F Agrafeuse pneumatique
I Cucitrice pneumatica
E Engrapadora pneumatica
CN 气动码钉枪

7
bar

8-25
mm

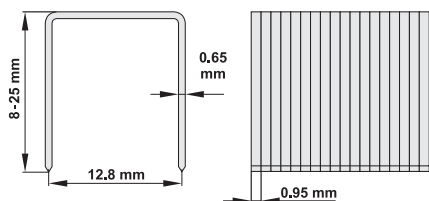

$L_{pa} = 74,7 \pm 2,5$ dB;
 $L_{ma} = 87,7 \pm 2,5$ dB;
 $a_p = 3,14 \pm 1,5$ m/s²



• application: industry, construction
• przeznaczenie: przemysł, budownictwo

YATO	
YT-0920	5

GB Pneumatic nailing machine
D Druckluftnagelgerät
PL Gwoździarka pneumatyczna
RUS Пневматическая гвоздильная машина
CZ Pneumatický nastřelovač hřebíků
H Pneumatikus szögbelevő
RO Capsator pneumatic

F Cloueur pneumatique
I Chiodatrice pneumatica
E Máquina pneumática para clavar clavos
CN 气动码钉枪

8
bar

25-64
mm

90°

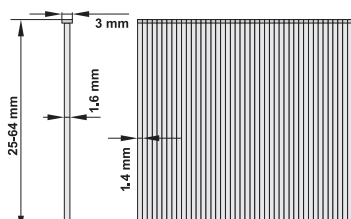

$L_{pa} = 62,3 \pm 2,5$ dB;
 $L_{ma} = 95,3 \pm 2,5$ dB;
 $a_p = 3,29 \pm 1,5$ m/s²



• application: industry, construction
• przeznaczenie: przemysł, budownictwo

YATO	
YT-0921	5

GB Pneumatic nailing machine
D Druckluftnagelgerät
PL Gwoździarka pneumatyczna
RUS Пневматическая гвоздильная машина
CZ Pneumatický nastřelovač hřebíků
H Pneumatikus szögbelevő
RO Capsator pneumatic
F Cloueur pneumatique
I Chiodatrice pneumatica
E Máquina pneumática para clavar clavos
CN 气动码钉枪

8
bar

50-90
mm

34°

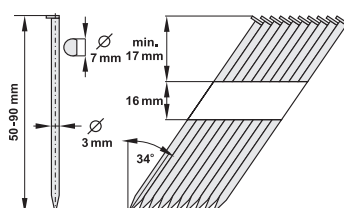

$L_{pa} = 84,2 \pm 3,0$ dB;
 $L_{ma} = 97,2 \pm 3,0$ dB;
 $a_p = 4,2 \pm 0,65$ m/s²















• application: industry, construction
• przeznaczenie: przemysł, budownictwo

YATO	
YT-0923	2

16

Special automotive tools & equipment Narzędzia i wyposażenie warsztatu samochodowego



Cabinets Szafki		269-287	Brake system tools Narzędzia do obsługi układu hamulcowego		326-330
Roller cabinets with tools insert Szafki serwisowe z narzędziami		269	Suspension system tools Narzędzia do obsługi podwozia		331-334
Tool cabinets Szafki serwisowe		276	Spring clamps & accessories Ściągacze do sprężyn i akcesoria		331
Workbenches Stoły warsztatowe		279	Shock absorber nut sets Zestawy nasadek do amortyzatorów		332
Tools in PVC trays Zestawy narzędzi do szuflad		280	Tire valve stem inserter Przeciągacze do zaworów gumowych		332
Accessories for tool cabinets & workbenches Akcesoria do szafek i stołów		286	Wheel balance pliers Szczypce do wyważania kół		333
Tool boxes Skrzynki narzędziowe		288-290	Deep thin wall impact sockets 1/2" Udarowe klucze nasadowe 1/2" do felg aluminiowych		333
Lubrication system tools Narzędzia do obsługi układu smarowania		290-296	Valve core torque tools Klucze dynamometryczne do zaworków gumowych i metalowych		333
Oil filter wrenches & sets Klucze do filtra oleju i zestawy		290	Wheel wrenches Klucze do kół		333
Oil drain plug sockets Klucze do spustu oleju		292	Tire levels Łyżki do opon		334
Grease guns & accessories Smarownice ręczne, pneumatyczne i akcesoria		293	Workshop tools Narzędzia warsztatowe		334-345
Oil cans Oliwiarki		296	Inspection tools Narzędzia inspekcyjne		334
Oil and fuel pumps Pompy do oleju oraz paliwa		296	Magnetic pick up tools Chwytki magnetyczne		335
Pullers Ściągacze		297-307	Magnetic trays Tacki magnetyczne		335
Pullers Ściągacze		297	Tweezers Pęsety		336
Roller stud extractor sets Zestawy ściągaczy do szpilek		302	Workshop creepers Leżanki warsztatowe		336
Upholstery removers Ściągacze do tapicerki		307	LED workshop lightning Oświetlenie warsztatowe LED		337
Car window tools Narzędzia do szyb samochodowych		307-308	Flashlights Latarki		342
Fuel feel pipe pliers Szczypce motoryzacyjne		309-313	Voltage testers Próbniki napięcia		343
Engine repair tools Narzędzia do obsługi silnika		314-326	Number & letter stamps Znaczniki cyfrowe i literowe		344
Piston ring compressors Zaciskacze do pierścieni		314	Thread repair sets & accessories Zestawy do naprawy gwintów i akcesoria		344
Engine repair and diagnostic tools Narzędzia do diagnostyki i naprawy silników		314	Tire pressure gauges Mierniki ciśnienia		344
Spark plug sockets Klucze do świec		326	Pumps Pompki		345
			Funnels, oil drainer & drainer pans Lejki, miski i zlewarki do oleju		345-346
			Bottle & floor jacks Dźwigniki słupkowe i podnośniki		347-348

Jack stands
Podstawki pod samochód

348



Electric hoists
Elektryczne wciągarki linowe

353



Battery chargers, jump starters, power inverters & battery testers
Prostowniki, urządzenia rozruchowe, przetwornice napięcia i testety akumulatorów

349-352



Hand pullers
Wciągarki linowe, ręczne

354



Refractometers
Refraktometry

352



Shop cranes & shop presses
Żurawie i prasy warsztatowe

354-355



Chain blocks
Wciągarki łańcuchowe

353



Workshop standardized parts
Normalia motoryzacyjne

356-366



Lever blocks
Wciągarki łańcuchowe dźwigniowe

353



GB Service tool cabinet with tools
D Serviceschrank mit Werkzeugen
PL Szafka serwisowa z narzędziami
RUS Сервисный шкаф с инструментами
CZ Servisní skříňka s náradím
H Szervizszekrény szerszámmal

RO Cutie de service cu scule
F Servante d'atelier - set d'outils
I Armadio per utensili
E Armario para herramientas de servicio
CN 工具车托盘组套

WHITE
CARTON BOX
& COLOR LABEL



141 PCS
12 TRAY
WKLAD

932x665
x453 mm

7x

BALL BEARING
ŁOŻYSKA
KULKOWE

25kg
35kg
35kg

CENTRAL LOCK
CENTRALNY ZAMEK

WHEELS
FOŁKI
Ø 125 mm

2x BRAKE
HAMULCE

NON SLIP
WORKTOP
BLAT
ANTIPOŚLIZGOWY

UNIVERSAL PERFORATION
UNIWERSALNA PERFORACJA

2x



12 interchangeable trays with YATO tools
12 wymiennych modułów z narzędziami YATO

DRAWER / SZUFLADA 1

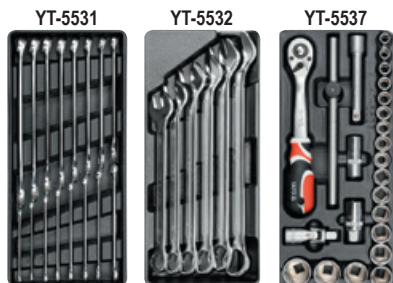

YT-5531

YT-5532

YT-5537

DRAWER / SZUFLADA 2

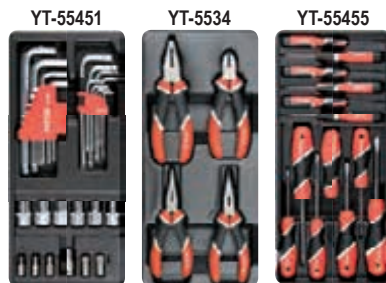

YT-55451

YT-5534

YT-55455

DRAWER / SZUFLADA 3



YT-5540

YT-55473

YT-55471

DRAWER / SZUFLADA 4



YT-55453

YT-55474

YT-55466

DRAWER / SZUFLADA 1

1/2" (12.7 mm): 10, 11, 12, 13, 14, 15, 16, 17, 18, 19, 20, 21, 22, 23, 24, 27, 30, 32 mm; CrV 50BV30; 1/2" (12.7 mm): (255 mm); 72T; CrV 6140; 1/2" (12.7 mm); (255 mm); CrV 50BV30; 1/2" (12.7 mm): 16; 21 mm; CrV 50BV30; 1/2" (12.7 mm): (127 mm); CrV 50BV30; 1/2" (12.7 mm); CrV 50BV30; 6, 7, 8, 9, 10, 11, 12, 13, 14, 15, 16, 17, 18, 19, 20, 21 mm; CrV: 22, 24, 27, 28, 30, 32 mm; CrV

DRAWER / SZUFLADA 2

1/2" (12.7 mm): E10, E12, E14, E16, E18, E20 (L=38 mm); CrV 50BV30; M5, M6, M8, M10, M12 (L=30 mm); AISI S2; 1/2" (12.7 mm): 10 mm; CrV 6150; 2, 2.5, 3, 4, 5, 6, 7, 8, 10, 12 mm; CrV 6150; T10, T15, T20, T25, T27, T30, T40, T45, T50; CrV 6150; 180 mm; 160 mm; 160 mm; 160 mm LONG; NOSE: 160 mm BENT NOSE; 3x75, 4x100, 5x75, 6x100 mm; PH0x75, PH1x75, PH2x100 mm; S2; 1.4x50, 2.0x50, 2.4x50 mm; PH00x50, PH0x50, PH1x50 mm; S2

DRAWER / SZUFLADA 3

300 g (L=300 mm); 40 mm (L=350 mm); 250 mm; CrV; 10x8x142 mm, 12x10x152 mm, 16x13x172 mm; 250 mm; CrV; 125 mm; CrMo; 300 mm; CrV; 140 mm; 200 mm; 19 mm x 20 mm; 4x190 mm; 250 V; 1.0, 1.5, 2.0, 2.5, 3.0, 3.5, 4.0, 4.5, 5.0, 5.5, 6.0, 6.5, 7.0, 7.5, 8.0, 8.5, 9.0, 9.5, 10.0 mm

DRAWER / SZUFLADA 4

#2, 200 mm; #2, 200 mm; #2, 200 mm; #2, 200 mm; 300 mm; 0-150 mm; 2 m; 3m x 16 mm; 0.02-1.00 mm; 2.4, 3.2, 4.0, 4.8 mm; 9.6x3.2, 9.6x4.0, 12.7x4.0, 9.6x4.8, 12.7x4.8 mm

YATO drawers / szuflady		
YT-55291	7	1

GB Service tool cabinet with tools
D Serviceschrank mit Werkzeugen
PL Szafka serwisowa z narzędziami
RUS Сервисный шкаф с инструментами
CZ Servisní skříňka s nářadím
H Szervizszekrény szerszámmal

RO Cutie de service cu scule
F Servante d'atelier - set d'outils
I Armadio per utensili
E Armario para herramientas de servicio
CN 工具车托盘组套

GREY
 CARTON BOX
 & COLOR LABEL



162 PCS 3 TRAY WKŁAD	905x680 x455 mm	3x	BALL BEARING ŁOŻYSKA KULKOWE	NON SLIP BAMBUO WORKTOP ANTYPOŚLĘGOWY BAMBUSOWY BLAT
DRAWERS LOCKING BŁOKADA SZUFLAD	CENTRAL LOCK CENTRALNY ZAMEK	WHEELS 125 mm	2x BRAKE HAMULCE	UNIVERSAL PERFORATION UNIWERSALNA PERFORACJA
310x200 mm FOLDING SHELF ROZKŁADANA POLKA	2x1			



DRAWER / SZUFLADA 1



- 8, 9, 10, 11, 12, 13, 14, 15, 16, 17, 18, 19, 21 mm; CrV;
- 8x10, 11x12, 13x14, 15x17 mm; CrV 6140;
- 1/2" (12.7 mm) (F) x 3/8" (9.5 mm) (M); CrV 50BV30;
- 3/8" (9.5 mm); 63-120 mm; CrV;
- 200 mm; 140 mm;
- 190-770 mm; 100 mm;
- 6-24 V; 1.5 V; 9 LED

DRAWER / SZUFLADA 2



- 1/2" (12.7 mm): 20, 22, 24 mm (L=38 mm); 27, 30, 32 mm (L=42 mm); 3/8" (9.5 mm): 9, 10, 11, 12, 13, 14, 15, 16 mm (L=28 mm); 17, 18, 19 mm (L=30 mm); 1/4" (6.3 mm): 4, 5, 6, 7, 8, 9, 10, 11, 12, 13 mm (L=25 mm); CrV 50BV30; 1/4" (6.3 mm): 8, 10, 11, 12 (L=50 mm); CrV 50BV30; 1/2" (12.7 mm): 10, 12, 13, 14, 17, 19 mm (L=78 mm); 12 pt; CrV 50BV30; 1/2" (12.7 mm): 17, 19, 21 mm (L=39 mm); CrMo SCM-440; 3/8" (9.5 mm): E10, E12, E14, E16, E18 (L=28 mm); 1/4" (6.3 mm): E4, E5, E6, E7, E8 (25 mm); CrV 6150; 1/2" (12.7 mm): (127, 254 mm); 3/8" (9.5 mm): (76, 152.4 mm); 1/4" (6.3 mm): (50.8 mm); CrV 50BV30; 3/8" (9.5 mm) (F) x 1/2" (12.7 mm) (M); CrV 50BV30; 1/2" (12.7 mm); 3/8" (9.5 mm); 1/4" (6.3 mm); CrV 50BV30; 3/8" (9.5 mm): 16, 21 mm; CrV 50BV30; 3/8" (9.5 mm): 14 mm; 12 pt; CrV; 1/2" (12.7 mm): (255 mm); 3/8" (9.5 mm): (200 mm); 1/4" (6.3 mm): (155 mm); 7/2"; CrV 6140; 1/4" (6.3 mm): (150 mm); CrV 50BV30; 3/8" (9.5 mm) x 5/16" (7.9 mm); CrV 6140; 1/4" (6.3 mm) x 1/4" (6.3 mm); CrV 6140; 5/16" (7.9 mm): 5.5, 6.5 mm (L=70 mm); 1/4" (6.3 mm): 4, 5, 6 mm (L=25 mm); AISI S2; 5/16" (7.9 mm): PH1 x2, PH2 x2, PH3 (L=70 mm); 1/4" (6.3 mm): PH1x2, PH2x2, PH3 (L=25 mm); AISI S2; 1/4" (6.3 mm): T10, T15, T20, T25, T27, T30, T40 (L=70 mm); AISI S2; 5/16" (7.9 mm): T20, T30, T40, T45, T50, T55, T60 (L=70 mm); AISI S2; 5/16" (7.9 mm): 4, 5, 6, 7, 8 mm (L=70 mm); 1/4" (6.3 mm): 3, 4, 5, 6, 7 mm (L=25 mm); AISI S2; 5/16" (7.9 mm): M5, M6, M8, M10, M12 (L=70 mm); AISI S2

DRAWER / SZUFLADA 3



- 6x38, 3x75 mm; S2; PH0x75, PH2x38 mm; S2;
- 6x100 mm; CrV 6150; PH2x100 mm; CrV 6150;
- 180 mm; CrV 50; 160 mm; CrV 50; 150 mm;
- 160 mm LONG NOSE; CrV 6150;
- 180 mm; CrV 50; EXTERNAL STRAIGHT / PROSTE ZEWNĘTRZNE;
- 180 mm; CrV 50; INTERNAL STRAIGHT / PROSTE WEWNĘTRZNE;
- 180 mm; CrV 50; EXTERNAL BENT / WYGIĘTE ZEWNĘTRZNE;
- 180 mm; CrV 50; INTERNAL BENT / WYGIĘTE WEWNĘTRZNE;
- 180; CrMo;
- 1.5, 2, 2.5, 3, 4, 5, 6, 8, 10 mm; CrV 6150

YATO	drawers / szuflady	
YT-55280	3	1

GB Service tool cabinet with tools
D Serviceschrank mit Werkzeugen
PL Szafka serwisowa z narzędziami
RUS Сервисный шкаф с инструментами
CZ Servisní skříňka s nářadím
H Szervizszekrény szerszámmal

RO Cutie de service cu scule
F Servante d'atelier - set d'outils
I Armadio per utensili
E Armario para herramientas de servicio
CN 工具车托盘组套

WHITE
CARTON BOX
& COLOR LABEL



165 PCS
13 TRAY
WKLAD

958x766
x465 mm

7x

BALL BEARING
ŁOŻYSKA
KULKOWE

25kg
35kg

DRAWERS
LOCKING
BŁOKADA
SZUFLADY

CENTRAL
LOCK
CENTRALNY
ZAMEK

NON SLIP
WORKTOP
BLAT
ANTIPOŚLIZGOWY

SWEEP
Ø
125
mm

BRAKE
HAMULEC

3x

UNIVERSAL
PERFORMANCE
UNIERSALNA
PERFORACJA

DOUBLE
WALLS
PODWÓJNE
SCIANY

CORNER BUMPERS
NARÓŻNE ODOJNIKI

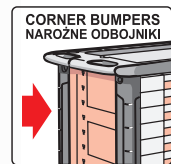

13 interchangeable trays with YATO tools
13 wymiennych modułów z narzędziami YATO

DRAWER / SZUFLADA 1

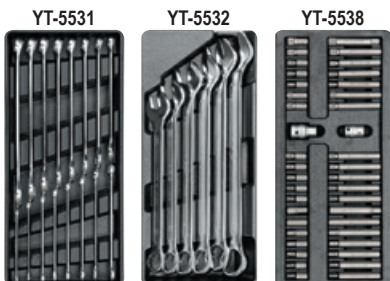

DRAWER / SZUFLADA 2

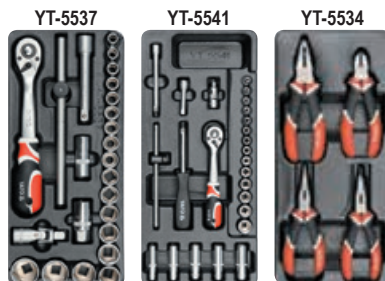

DRAWER / SZUFLADA 3

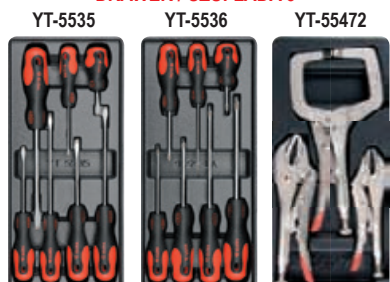

DRAWER / SZUFLADA 4



DRAWER / SZUFLADA 5



DRAWER / SZUFLADA 1

○ □ □ H4, H5, H6, H7, H8, H10, H12 (L=30 mm); H4, H5, H6, H7, H8, H10, H12 (L=75 mm); AISI S2: ○ □ □ M5, M6, M8, M10, M12 (L=30 mm); M5, M6, M8, M10, M12 (L=75 mm); AISI S2: ○ □ □ T20, T25, T30, T40, T45, T50, T55 (L=30 mm); T20, T25, T30, T40, T45, T50, T55 (L=75 mm); AISI S2: □ □ □ 1/2" (12.7 mm), 3/8" (9.5 mm); □ □ □ 6, 7, 8, 9, 10, 11, 12, 13, 14, 15, 16, 17, 18, 19, 20, 21 mm; CrV; □ □ □ 22, 24, 27, 28, 30, 32 mm; CrV

DRAWER / SZUFLADA 2

□ □ □ 1/2" (12.7 mm): 10, 11, 12, 13, 14, 15, 16, 17, 18, 19, 20, 21, 22, 23, 24, 27, 30, 32 mm; CrV 50BV30: □ □ □ 1/2" (12.7 mm): (255 mm); 72T; CrV 6140: □ □ □ 1/2" (12.7 mm): (255 mm); CrV 50BV30: □ □ □ 1/2" (12.7 mm): 16; 21 mm; CrV 50BV30: □ □ □ 1/2" (12.7 mm): (127 mm); CrV 50BV30: □ □ □ 1/2" (12.7 mm): CrV 50BV30: □ □ □ 1/4" (6.3 mm): 3, 5, 4, 0, 4, 5, 5, 0, 5, 5, 6, 0, 7, 0, 8, 0, 9, 0, 10, 0, 11, 0, 12, 0, 13, 0, 14, 0 mm; CrV 50BV30: □ □ □ 1/4" (6.3 mm): 8, 10, 11, 12, 13 mm; CrV 50BV30: □ □ □ 1/4" (6.3 mm): (50.8, 101.6 mm); CrV 6140: □ □ □ 1/4" (6.3 mm); CrV 50BV30: □ □ □ 1/4" (6.3 mm): (155 mm); 72T; CrV 6140: □ □ □ 1/4" (6.3 mm): (150 mm); CrV 50BV30: □ □ □ 180 mm; 160 mm; 160 mm LONG NOSE: □ □ □ 160 mm BENT NOSE

DRAWER / SZUFLADA 3

□ □ □ 3x75, 5x100, 5x150, 6x38, 6x100, 6x150, 8x150 mm; CrMo; □ □ □ PH0x100, PH1x75, PH1x100, PH2x38, PH2x100, PH2x150, PH3x150 mm; CrMo; □ □ □ 180, 250 mm; □ □ □ 280 mm

DRAWER / SZUFLADA 4

□ □ □ 3/4" (19.0 mm): 21, 22, 24, 27, 28, 29, 30, 32, 34, 36, 41, 46, 50, 55 mm; CrV 50BV30: □ □ □ 3/4" (19.0 mm): (200 mm); CrV 6140: □ □ □ 3/4" (19.0 mm); CrV 50BV30: □ □ □ 3/4" (19.0 mm): (500 mm); 72T; CrV 6140: □ □ □ 3/4" (19.0 mm): (500 mm); CrV 50BV30

DRAWER / SZUFLADA 5

○ □ □ 1/2" (12.7 mm) x 5/16" (7.9 mm); □ □ □ PH3 (L=35 mm); PH1, PH2, PH3 (L=75 mm); □ □ □ 8 mm (L=35 mm); 8 mm (L=75 mm); □ □ □ 12-38 mm; □ □ □ 3" (75 mm); □ □ □ 82 mm; □ □ □ 200 mm; □ □ □ 135 mm; □ □ □ 300, 400, 500 mm

YATO	drawers / szuflady	
YT-55293	7	1

GB Service tool cabinet with tools
D Serviceschrank mit Werkzeugen
PL Szafka serwisowa z narzędziami
RUS Сервисный шкаф с инструментами
CZ Servisní skříňka s nářadím
H Szervizszekrény szerszámmal

RO Cutie de service cu scule
F Servante d'atelier - set d'outils
I Armadio per utensili
E Armario para herramientas de servicio
CN 工具车托盘组套

WHITE
 CARTON BOX
 & COLOR LABEL



177 PCS 12 TRAY WKŁAD	958x766 x 465 mm	6x	BALL BEARING ŁOŻYSKA KULKOWE	25kg 35kg 35kg
DRAWERS LOCKING BLOKADA SZUFLAD	NON SLIP POLYPROPYLENE WORKTOP ANTYPOŚLIZGOWY POLIPROPYLENOWY BLAT	WHEEL ϕ 125 mm	DOUBLE WALLS PODWÓJNE SCIANY	BRAKE HAMULEC
UNIVERSAL PERFORATION UNIWERSALNA PERFORACJA	CORNER BUMPERS NAROŻNE ODBOJNIKI	2x1		



12 interchangeable trays with YATO tools
12 wymiennych modułów z narzędziami YATO

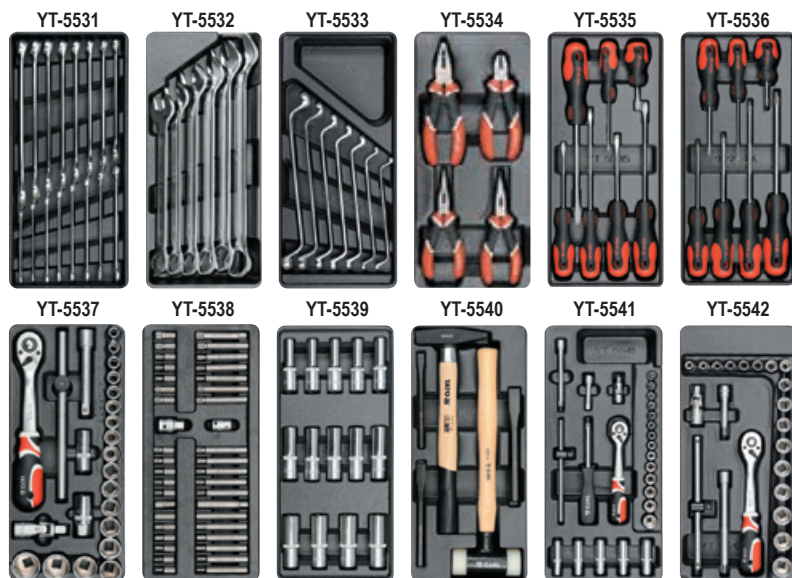

DRAWER / SZUFLADA 1

22, 24, 27, 28, 30, 32 mm: CrV; 6, 7, 8, 9, 10, 11, 12, 13, 14, 15, 16, 17, 18, 19, 20, 21 mm: CrV; 6x7, 8x9, 10x11, 12x13, 14x15, 16x17, 18x19 mm: CrV

DRAWER / SZUFLADA 2

3x75, 5x100, 5x150, 6x38, 6x100, 6x150, 8x150 mm: CrMo; PH0x100, PH1x75, PH1x100, PH2x38, PH2x100, PH2x150, PH3x150 mm: CrMo; 180mm, 160mm; 160 mm LONG NOSE; 160 mm BENT NOSE

DRAWER / SZUFLADA 3

1/2" (12.7 mm): 10, 11, 12, 13, 14, 15, 16, 17, 18, 19, 20, 21, 22, 23, 24, 27, 30, 32 mm: CrV 50BV30; 1/2" (12.7 mm): 127 mm: CrV 50BV30; 1/2" (12.7 mm): 255 mm: 72T: CrV 6140; 1/2" (12.7 mm): 255 mm: CrV 50BV30; 1/2" (12.7 mm): 16; 21 mm: CrV 50BV30; H4, H5, H6, H7, H8, H10, H12 (L=30 mm); H4, H5, H6, H7, H8, H10, H12 (L=75 mm); M5, M6, M8, M10, M12 (L=30 mm); M5, M6, M8, M10, M12 (L=75 mm); AISI S2; T20, T25, T30, T40, T45, T50, T55 (L=30 mm); T20, T25, T30, T40, T45, T50, T55 (L=75 mm); AISI S2; 1/2" (12.7 mm), 3/8" (9.5 mm); 1/2" (12.7 mm): 8, 9, 10, 11, 12, 13, 14, 15, 16, 17, 18, 19, 20, 21 mm (L=76 mm); CrV 50BV30

DRAWER / SZUFLADA 4

300 g (L=300 mm); 40 mm (L=350 mm); 10x8x142 mm, 12x10x152 mm, 16x13x172 mm; 3/8" (9.5 mm): 6, 7, 8, 9, 10, 11, 12, 13, 14, 15, 16, 17, 18, 19, 20, 21, 22 mm: CrV 50BV30; 3/8" (9.5 mm): (76, 152.4 mm); CrV 50BV30; 3/8" (9.5 mm): CrV 50BV30; 3/8" (9.5 mm); (200 mm); 72T: CrV 6140; 3/8" (9.5 mm): (198 mm); CrV 50BV30; 1/4" (6.3 mm): 3.5, 4, 4.5, 5, 5.5, 6, 7, 8, 9, 10, 11, 12, 13, 14 mm: CrV 50BV30; 1/4" (6.3 mm): 8, 10, 11, 12, 13 mm: CrV 50BV30; 1/4" (6.3 mm): (50.8, 101.6 mm); CrV 6140; 1/4" (6.3 mm): CrV 50BV30; 1/4" (6.3 mm): (155 mm); 72T: CrV 6140; 1/4" (6.3 mm): (150 mm); CrV 50BV30; 1/4" (6.3 mm): (152.4 mm); CrV 50BV30

YATO	drawers / szuflady	
YT-5530	6	1

GB Service tool cabinet with tools
D Serviceschrank mit Werkzeugen
PL Szafka serwisowa z narzędziami
RUS Сервисный шкаф с инструментами
CZ Servisní skříňka s nářadím
H Szervizszekrény szerszámmal

RO Cutie de service cu scule
F Servante d'atelier - set d'outils
I Armadio per utensili
E Armario para herramientas de servicio
CN 工具车托盘组套

WHITE
CARTON BOX
& COLOR LABEL



177 PCS
12 TRAY
WKŁAD

975x765
x465 mm

6x

BALL BEARING
ŁOŻYSKA
KULKOWE

25kg
35kg

DRAWERS
LOCKING
BLOKADA
SZUFLAD

NON SLIP
POLYPROPYLENE
WORKTOP
ANTYPOŚLIZGOWY
POLIPROPYLENOWY
BLAT

WHEEL Ø
125 mm

2x
BRAKE
HAMULCE

UNIVERSAL
PERFORATION
UNIWERSALNA
PERFORACJA

DOUBLE
WALLS
PODWÓJNE
SCIANY

2x

CORNER BUMPERS
NARÓŻNE ODBOJNIKI



12 interchangeable trays with YATO tools
12 wymiennych modułów z narzędziami YATO

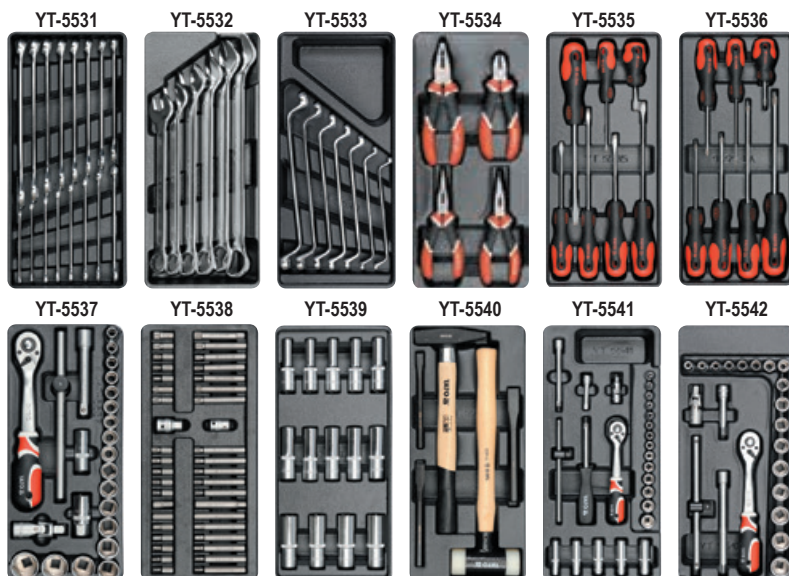

DRAWER / SZUFLADA 1

22, 24, 27, 28, 30, 32 mm; CrV: 6, 7, 8, 9, 10, 11, 12, 13, 14, 15, 16, 17, 18, 19, 20, 21 mm; CrV: 6x7, 8x9, 10x11, 12x13, 14x15, 16x17, 18x19 mm; CrV

DRAWER / SZUFLADA 2

3x75, 5x100, 5x150, 6x38, 6x100, 6x150, 8x150 mm; CrMo: PH0x100, PH1x75, PH1x100, PH2x38, PH2x100, PH2x150, PH3x150 mm; CrMo: 180mm, 160mm, 160 mm LONG NOSE; 160 mm BENT NOSE

DRAWER / SZUFLADA 3

1/2" (12.7 mm): 10, 11, 12, 13, 14, 15, 16, 17, 18, 19, 20, 21, 22, 23, 24, 27, 30, 32 mm; CrV 50BV30: 1/2" (12.7 mm); (127 mm): CrV 50BV30: 1/2" (12.7 mm); CrV 50BV30: 1/2" (12.7 mm); (255 mm): CrV 6140: 1/2" (12.7 mm); CrV 50BV30: 1/2" (12.7 mm); (12.7 mm): 16; 21 mm; CrV 50BV30: H4, H5, H6, H7, H8, H10, H12 (L=30 mm); H4, H5, H6, H7, H8, H10, H12 (L=75 mm); AISI S2: M5, M6, M8, M10, M12 (L=30 mm); M5, M6, M8, M10, M12 (L=75 mm); AISI S2: T20, T25, T30, T40, T45, T50, T55 (L=30 mm); T20, T25, T30, T40, T45, T50, T55 (L=75 mm); AISI S2: 1/2" (12.7 mm), 3/8" (9.5 mm); 1/2" (12.7 mm): 8, 9, 10, 11, 12, 13, 14, 15, 16, 17, 18, 19, 20, 21 mm (L=76 mm); CrV 50BV30

DRAWER / SZUFLADA 4

300 g (L=300 mm); 40 mm (L=350 mm); 10x8x142 mm, 12x10x152 mm, 16x13x172 mm; 3/8" (9.5 mm): 6, 7, 8, 9, 10, 11, 12, 13, 14, 15, 16, 17, 18, 19, 20, 21, 22 mm; CrV 50BV30: 3/8" (9.5 mm); (76, 152.4 mm); CrV 50BV30: 3/8" (9.5 mm); CrV 50BV30: 3/8" (9.5 mm); (200 mm); 72T: CrV 6140: 3/8" (9.5 mm); (198 mm); CrV 50BV30: 1/4" (6.3 mm): 3.5, 4, 4.5, 5, 5.5, 6, 7, 8, 9, 10, 11, 12, 13, 14 mm; CrV 50BV30: 1/4" (6.3 mm): 8, 10, 11, 12, 13 mm; CrV 50BV30: 1/4" (6.3 mm); (50.8, 101.6 mm); CrV 6140: 1/4" (6.3 mm); CrV 50BV30: 1/4" (6.3 mm); (155 mm); 72T: CrV 6140: 1/4" (6.3 mm); (150 mm); CrV 50BV30: 1/4" (6.3 mm); (152.4 mm); CrV 50BV30

YATO	drawers / szuflady	
YT-55300	6	1

GB Service tool cabinet with tools
D Serviceschrank mit Werkzeugen
PL Szafka serwisowa z narzędziami
RUS Сервисный шкаф с инструментами
CZ Servisní skříňka s nářadím
H Szervizszekrény szerszámmal

RO Cutie de service cu scule
F Servante d'atelier - set d'outils
I Armadio per utensili
E Armario para herramientas de servicio
CN 工具车托盘组套

WHITE
 CARTON BOX
 & COLOR LABEL



189 PCS 14 TRAY WKLAD	958x766 x465 mm	7x	BALL BEARING ŁOŻYSKA KULKOWE	25kg ↓ 35kg ↑
DRAWERS LOCKING BLOKADA SZUFLAD	CENTRAL LOCK CENTRALNY ZAMEK	NON SLIP WORKTOP BLAT ANTIPOŚLIZGOWY	WHEEL Ø 125 mm KOŁO	BRAKE HAMULEC
3x KEY	UNIVERSAL PERFORMANCE UNIWERSALNA PERFORACJA	DOUBLE WALLS PODWÓJNE SCIANY	CORNER BUMPERS NAROŻNE ODBOJNIKI	



DRAWER / SZUFLADA 1

○ □ H4, H5, H6, H7, H8, H10, H12 (L=30 mm); H4, H5, H6, H7, H8, H10, H12 (L=75 mm); AISI S2: ○ □ M5, M6, M8, M10, M12 (L=30 mm); M5, M6, M8, M10, M12 (L=75 mm); AISI S2: ○ □ T20, T25, T30, T40, T45, T50, T55 (L=30 mm); T20, T25, T30, T40, T45, T50, T55 (L=75 mm); AISI S2: □ □ 1/2" (127 mm), 3/8" (9.5 mm); ⚙️ 6, 7, 8, 9, 10, 11, 12, 13, 14, 15, 16, 17, 18, 19, 20, 21 mm; CrV; ⚙️ 22, 24, 27, 28, 30, 32 mm; CrV

DRAWER / SZUFLADA 2

□ 1/2" (12.7 mm): 10, 11, 12, 13, 14, 15, 16, 17, 18, 19, 20, 21, 22, 23, 24, 27, 30, 32 mm; CrV 50BV30; ⚙️ 1/2" (12.7 mm); (255 mm); 72T; CrV 6140; ⚙️ 1/2" (12.7 mm); (255 mm); CrV 50BV30; □ 1/2" (12.7 mm): 16; 21 mm; CrV 50BV30; ⚙️ 1/2" (12.7 mm): (127 mm); CrV 50BV30; ⚙️ 1/2" (12.7 mm); CrV 50BV30; ⚙️ 180 mm; ⚙️ 160 mm; ⚙️ 160 mm LONG; NOSE; ⚙️ 160 mm BENT NOSE; ⚙️ 300 g (L=300 mm); ⚙️ 40 mm (L=350 mm); ⚙️ 10x8x142 mm, 12x10x152 mm, 16x13x172 mm

DRAWER / SZUFLADA 3

⚙️ 3x75, 4x100, 5x75, 6x100 mm; PH0x75, PH1x75, PH2x100 mm; S2; ⚙️ 1.4x50, 2.0x50, 2.4x50 mm; PH00x50, PH0x50, PH1x50 mm; S2; ⚙️ 6x150, 8x200; PH2x150, PH3x200; CrV; ⚙️ 200, 250 mm; CrV; ⚙️ 250 mm; CrMo; ⚙️ 150 mm; CrV

DRAWER / SZUFLADA 4

⚙️ 3x: M3x0.5, M4x0.7, M5x0.8, M6x1.0, M7x1.0, M8x1.25, M10x1.5, M12x1.75; ⚙️ M3x0.5, M4x0.7, M5x0.8, M6x1.0, M7x1.0, M8x1.25, M10x1.5, M12x1.75; ⚙️ 0.5 - 1.75 mm; 27G; 28G; ⚙️ M7-M9; ⚙️ M3-M12; ⚙️ 180 mm; EXTERNAL STRAIGHT; ⚙️ 180 mm; INTERNAL STRAIGHT; ⚙️ 180 mm; EXTERNAL BENT; ⚙️ 180 mm; INTERNAL BENT; ⚙️ #2, 200 mm; □ #2, 200 mm; △ #2, 200 mm; □ #2, 200 mm; ○ #2, 200 mm

DRAWER / SZUFLADA 5

⚙️ 140 mm; ⚙️ 200 mm; ⚙️ 19 mm x 20 mm; ⚙️ 4x190 mm; 250 V; ⚙️ 1.0, 1.5, 2.0, 2.5, 3.0, 3.5, 4.0, 4.5, 5.0, 5.5, 6.0, 6.5, 7.0, 7.5, 8.0, 8.5, 9.0, 9.5, 10.0 mm; ⚙️ 1" (25 mm); (L=330 mm); ⚙️ 250 mm; ⚙️ 2.4, 3.2, 4.0, 4.8 mm; ⚙️ 9.6x3.2, 9.6x4.0, 12.7x4.8 mm

YATO	drawers / szuflady	
YT-55292	7	1

14 interchangeable trays with YATO tools
14 wymiennych modułów z narzędziami YATO

DRAWER / SZUFLADA 1

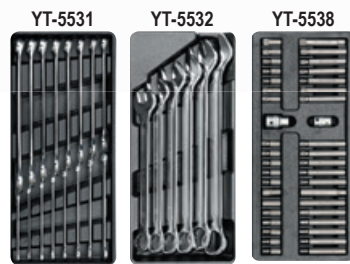

DRAWER / SZUFLADA 2

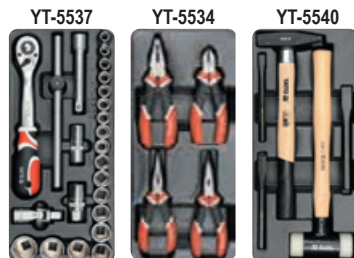

DRAWER / SZUFLADA 3



DRAWER / SZUFLADA 4

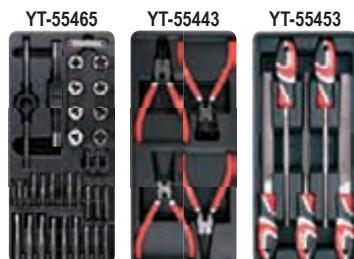

DRAWER / SZUFLADA 5



GB Service tool cabinet with tools
D Serviceschrank mit Werkzeugen
PL Szafka serwisowa z narzędziami
RUS Сервисный шкаф с инструментами
CZ Servisní skříňka s nářadím
H Szervizszekrény szerszámmal

RO Cutie de service cu scule
F Servante d'atelier - set d'outils
I Armadio per utensili
E Armario para herramientas de servicio
CN 工具车托盘组套

WHITE
CARTON BOX
& COLOR LABEL



211 PCS
5 TRAY
WKLAD

980x770
x465 mm

7x

BALL BEARING
ŁOŻYSKA KULKOWE

25kg
35kg
35kg

DRAWERS LOCKING
BLOKADA SZUFLAD

NON SLIP
PODPROPILENE
WORKTOP
ANTIPOŚLIZGOWY
POLIPROPILENOWY
BLAT

WHEEL Ø
125 mm

BRAKE
HAMULEC

3x

UNIVERSAL PERFORMANCE
UNIWERSALNA PERFORACJA

DOUBLE WALLS
PODWÓJNE ŚCIANY

CORNER BUMPERS
NARÓZNE ODOBJNIKI

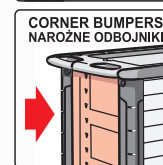

DRAWER / SZUFLADA 1

1/2" (12.7 mm): 8, 9, 10, 11, 12, 13, 14, 15, 16, 17, 18, 19, 20, 21, 22, 24 (L=38 mm); 27, 30, 32 mm (L=42 mm); 1/4" (6.3 mm): 4, 4.5, 5, 5.5, 6, 7, 8, 9, 10, 11, 12, 13 (L=25 mm); CrV 50BV30: 1/2" (12.7 mm): 10, 13, 14, 15, 17, 19, 21 mm (L=76 mm); 1/4" (6.3 mm): 6, 7, 8, 9, 10, 11, 12, 13 (L=50 mm); CrV 50BV30: 1/2" (12.7 mm): E10, E11, E12, E14, E16, 1/4" (6.3 mm): E4, E5, E6, E7, E8; CrV 50BV30: 1/2" (12.7 mm): (127, 254 mm); 1/4" (6.3 mm): (50.8, 101.6 mm); CrV 50BV30: 1/2" (12.7 mm): CrV 50BV30: 1/2" (12.7 mm): 16, 21 mm; CrV 50BV30: 1/2" (12.7 mm): (255 mm); 1/4" (6.3 mm): (152.4 mm); CrV 50BV30: 1/2" (12.7 mm): (255 mm); 1/4" (6.3 mm): (155 mm); CrV 6140: 1/4" (6.3 mm): (150 mm); CrV 50BV30: 1/4" (6.3 mm): 4, 5.5, 6.5 mm; AISI S2 / CrV 6150: 1/4" (6.3 mm): PH1 (x2), PH2 (x2), PH3; AISI S2 / CrV 6150: 1/4" (6.3 mm): PZ1, PZ2, PZ3; AISI S2 / CrV 6150: 1/4" (6.3 mm): T8, T10, T15, T20, T25, T30, T40; AISI S2 / CrV 6150: 1/4" (6.3 mm): 3, 4, 5, 6, 7, 8 mm; AISI S2 / CrV 6150

DRAWER / SZUFLADA 2

200 mm; CrV: Ø 3-6 mm (L=52 mm), Ø 6-8 (L=58 mm), Ø 8-11 (L=66 mm), Ø 11-14 (L=75 mm), Ø 14-18 (L=80 mm), Ø 18-25 (L=88 mm); 8, 9, 10, 11, 12, 13, 14, 15, 16, 17, 18, 19, 21, 22, 24 mm; CrV: T10, T15, T20, T25, T27, T30, T40, T45, T50; CrV 6150: 2, 2.5, 3, 4, 5, 6, 7, 8, 10, 12 mm; CrV 6150

DRAWER / SZUFLADA 3

6.0x38, 2.0x75, 3.0x75, 4.0x100, 5.0x100, 6.0x100 mm; PH0x100, PH1x100, PH2x38, PH2x150, PH3x150 mm; T7x75, T8x75, T9x75, T10x100, T15x100, T20x100, T25x100, T27x100 mm; S2; 6.0x150 mm; CrV 6150

DRAWER / SZUFLADA 4

180 mm; 160 mm; 200 mm; 250 mm; 400g; 340g; 12.5x152, 16.0x172 mm; CrV 6150; 3.0x150, 4.0x150, 5.0x150, 6.0x150, 8.0x150 mm; CrV 6150; 8.0x112 mm; CrV 6150

DRAWER / SZUFLADA 5

M3x0.5 (x3), M4x0.7 (x3), M5x0.8 (x3), M6x1.0 (x3), M7x1.0 (x3), M8x1.25 (x3), M10x1.5 (x3), M12x1.75 (x3); HSS M2; M3, M4x0.7, M5x0.8, M6x1.0, M7x1.0, M8x1.25, M10x1.5, M12x1.75; HSS M2; M7-M9; M3-M12; #2, 200 mm; #2, 200 mm; #2, 200 mm; LED; 3 m x 16 mm; 300 mm; 0-150 mm

YATO	drawers / szuflady	
YT-55290	7	1

DRAWER / SZUFLADA 1



DRAWER / SZUFLADA 2

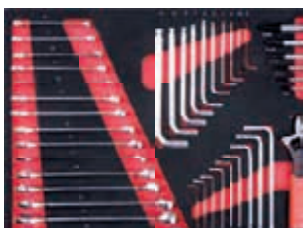

DRAWER / SZUFLADA 3



DRAWER / SZUFLADA 4



DRAWER / SZUFLADA 5



CREATE YOUR WORKPLACE - STWÓRZ SWOJE MIEJSCE PRACY

YT-09061



YT-08921



YT-09152



YT-08922





YT-08920

- GB** Tool chest
- D** Werkzeugkasten
- PL** Szafka warsztatowa
- RUS** Портативный ящик для инструментов
- CZ** Přenosná skříňka na nářadí
- H** Hordozható szerszámok láda
- RO** Cutie pt. instrumente portabile
- F** Servante d'atelier
- I** Banco da lavoro armadio
- E** Cajonera portátil
- CN** 驮鞍箱



690x465 x400 mm	4x	25kg	NON SLIP ABS WORKTOP ANTYPOŚLIZGOWY BLAT Z TWORZYWA ABS	UNIVERSAL PERFORATION UNIWERSALNA PERFORACJA
DRAWERS LOCKING BLOKADA SZUFLAD	CENTRAL LOCK CENTRALNY ZAMEK	2x1	DOUBLE WALLS PODWÓJNE SCIANY	CORNER BUMPERS NAROŻNE ODBOJNIKI



YATO 	drawers / szuflady	
YT-09152	4	1



16

- GB** Tool chest
- D** Werkzeugkasten
- PL** Szafka warsztatowa
- RUS** Портативный ящик для инструментов
- CZ** Přenosná skříňka na nářadí
- H** Hordozható szerszámok láda
- RO** Cutie pt. instrumente portabile
- F** Servante d'atelier
- I** Banco da lavoro armadio
- E** Cajonera portátil
- CN** 驮鞍箱



690x465 x535 mm	6x	25kg	NON SLIP ABS WORKTOP ANTYPOŚLIZGOWY BLAT Z TWORZYWA ABS	UNIVERSAL PERFORATION UNIWERSALNA PERFORACJA
DRAWERS LOCKING BLOKADA SZUFLAD	CENTRAL LOCK CENTRALNY ZAMEK	2x1	DOUBLE WALLS PODWÓJNE SCIANY	CORNER BUMPERS NAROŻNE ODBOJNIKI



YATO 	drawers / szuflady	
YT-09155	6	1

GB Roller cabinet
D Werkstattrollwagen
PL Szafka serwisowa
RUS Инструментальный кабинет
CZ Dílenská skříňka
H Szervíz - szekrény
RO Dulap de scule
F Servante d'atelier
I Armadio per utensili
E Armario en ruedas
CN 工具车

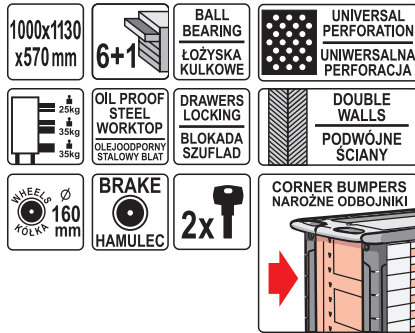

WHITE CARTON BOX & COLOR LABEL

YATO	drawers / szuflady	
YT-09002	6+1	1

GB Roller cabinet
D Werkstattrollwagen
PL Szafka serwisowa
RUS Инструментальный кабинет
CZ Dílenská skříňka
H Szervíz - szekrény
RO Dulap de scule
F Servante d'atelier
I Armadio per utensili
E Armario en ruedas
CN 工具车



WHITE CARTON BOX & COLOR LABEL

YATO	drawers / szuflady	
YT-0913	6	1

GB Roller cabinet
D Werkstattrollwagen
PL Szafka serwisowa
RUS Инструментальный кабинет
CZ Dílenská skříňka
H Szervíz - szekrény
RO Dulap de scule
F Servante d'atelier
I Armadio per utensili
E Armario en ruedas
CN 工具车

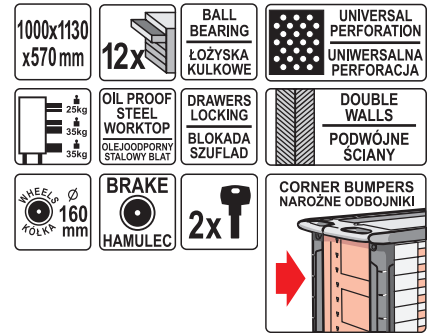

WHITE CARTON BOX & COLOR LABEL

YATO	drawers / szuflady	
YT-09003	12	1

GB Roller cabinet
D Werkstattrollwagen
PL Szafka serwisowa
RUS Инструментальный кабинет
CZ Dílenská skříňka
H Szervíz - szekrény
RO Dulap de scule
F Servante d'atelier
I Armadio per utensili
E Armario en ruedas
CN 工具车





WHITE CARTON BOX & COLOR LABEL

YATO	drawers / szuflady	
YT-0914	7	1



- GB Roller cabinet
- D Werkstattrollwagen
- PL Szafka serwisowa
- RUS Инструментальный кабинет
- CZ Dilenská skříňka
- H Szerviz - szekrény
- RO Dulap de scule
- F Servante d'atelier
- I Armadio per utensili
- E Armario en ruedas
- CN 工具车



958x766 x465 mm	6x 	NON SLIP POLYPROPYLENE WORKTOP ANTIPOŚLIZGOWY POLIPROPYLENYWY BLAT	 25kg 35kg 35kg	CORNER BUMPERS NAROŻNE ODBOJNIKI
	BALL BEARING ŁOŻYSKA KULKOWE	DOUBLE WALLS PODWÓJNE ŚCIANY	 125 mm	BRAKE HAMULEC



WHITE
CARTON BOX
& COLOR LABEL



YATO 	drawers / szuflady	
YT-0902	6	1



- GB Roller cabinet
- D Werkstattrollwagen
- PL Szafka serwisowa
- RUS Инструментальный кабинет
- CZ Dilenská skříňka
- H Szerviz - szekrény
- RO Dulap de scule
- F Servante d'atelier
- I Armadio per utensili
- E Armario en ruedas
- CN 工具车



975x765 x465 mm	6x 	NON SLIP POLYPROPYLENE WORKTOP ANTIPOŚLIZGOWY POLIPROPYLENYWY BLAT	 25kg 35kg 35kg	CORNER BUMPERS NAROŻNE ODBOJNIKI
	BALL BEARING ŁOŻYSKA KULKOWE	DOUBLE WALLS PODWÓJNE ŚCIANY	 125 mm	2x BRAKE HAMULEC

WHITE
CARTON BOX
& COLOR LABEL



YATO 	drawers / szuflady	
YT-5299	6	1



- GB Roller cabinet
- D Werkstattrollwagen
- PL Szafka serwisowa
- RUS Инструментальный кабинет
- CZ Dilenská skříňka
- H Szerviz - szekrény
- RO Dulap de scule
- F Servante d'atelier
- I Armadio per utensili
- E Armario en ruedas
- CN 工具车



932x665 x453 mm	7x 	NON SLIP POLYPROPYLENE WORKTOP ANTIPOŚLIZGOWY POLIPROPYLENYWY BLAT	 25kg 35kg 35kg	BALL BEARING ŁOŻYSKA KULKOWE
	UNIVERSAL PERFORATION UNIWERSALNA PERFORACJA	 125 mm	2x BRAKE HAMULEC	

WHITE
CARTON BOX
& COLOR LABEL



YATO 	drawers / szuflady	
YT-0900	7	1

GB Roller cabinet
D Werkstattrollwagen
PL Szafka serwisowa
RUS Инструментальный кабинет
CZ Dilenská skříňka
H Szerviz - szekrény
RO Dulap de scule
F Servante d'atelier
I Armadio per utensili
E Armario en ruedas
CN 工具车



WHITE
CARTON BOX
& COLOR LABEL



YATO drawers / szuflady
YT-09008 7 1

GB Workshop trolley
D Werkstatt-Servicewagen
PL Wózek warsztatowy
RUS Сервисная тележка
CZ Dilenský policový vozík



WHITE
CARTON BOX
& COLOR LABEL



YATO trays / półki
YT-55210 3 1

GB Shutter cabinet
D Werkstatt Hängeschrank
PL Szafka wisząca
RUS Шкафчик для инструмента настенный
CZ Zavěsná skříňka
H Szerszámtároló
RO Raft de scule
F Placard d'atelier
I Scaffale
E Armario colgante
CN 橙架



WHITE
CARTON BOX
& COLOR LABEL



YATO size / rozmiar (mm)
YT-09061 1375x714x145 1

GB Workbench
D Werkbank
PL Stół warsztatowy
RUS Бepcтaк
CZ Pracovní stůl
H Munkapad
RO Banc de lucru
F Table d'atelier
I Banco da lavoro
E Banco de trabajo
CN 工作台



WHITE
CARTON BOX
& COLOR LABEL



YATO size / rozmiar (mm)
YT-08920 1500x780x830 1

- GB** Drawer insert / Combination spanners
D Schubladeneinlage / Schrauben- und Ringschlüssel
PL Wkład do szuflady / Klucze płasko-oczkowe
RUS Вклад к выдвигному ящику / Плоско-закрытый накладной ключ
CZ Vložka do zásuvky / Klíče ploché-očkové
H Fiókbetét / Csillag - villás kulcsok
RO Adaos la sertar / Chei plane - inelare
F Module plastique pour servante avec clés mixtes
I Tenone per l'armadio chiavi
E Accesorio de cajón / Llave española de muletilla
CN 两用扳手托盘组套

PLASTIC TRAY & COLOR LABEL



CrV



6
PCS

22, 24, 27, 28, 30, 32 mm; CrV

YATO
YT-5532 4



16
PCS

6, 7, 8, 9, 10, 11, 12, 13, 14, 15, 16, 17, 18, 19, 20, 21 mm; CrV

YATO
YT-5531 8

- GB** Drawer insert / Bi-hexagonal ring spanner
D Schubladeneinlage / Doppelringschlüssel
PL Wkład do szuflady / Klucze oczkowe odgięte
RUS Вклад к выдвигному ящику / Ключ накидной изогнутый
CZ Vložka do zásuvky / Klíče očkové ohnuté
H Fiókbetét / Hajlítotszárú csillagkulcs
RO Adaos la sertar / Chei inelaro-curbată
F Module plastique pour servante clés contre-coudées
I Tenone per l'armadio chiavi
E Accesorio de cajón / Llave de estrella
CN 双头高颈梅花扳手托盘组套

PLASTIC TRAY & COLOR LABEL



CrV



4
PCS

21x23, 24x27, 25x28, 30x32 mm; CrV

YATO
YT-5543 8



7
PCS

6x7, 8x9, 10x11, 12x13, 14x15, 16x17, 18x19 mm; CrV

YATO
YT-5533 8

- GB** Drawer insert / L-type socket wrench
D Schubladeneinlage / Steckschlüssel gebogen
PL Wkład do szuflady / Klucz nasadowy typ „L”
RUS Вклад к выдвигному ящику / Ключ торцевой L-типа
CZ Vložka do zásuvky / Nástrčný klíč fajkový
H Fiókbetét / Kulcs, dugó-pipa
RO Adaos la sertar / Cheie tubulara cu cot tip „L”
F Module plastique pour servante / Clé a douille de type „L”
I Tenone per l'armadio / Chiave a tubo tipo „L”
E Accesorio de cajón / Llave de vaso „L”
CN L型套筒扳手托盘组套

PLASTIC TRAY & COLOR LABEL



10
PCS

CrV



7, 8, 9, 10, 11, 12, 13, 14, 17, 19 mm

YATO
YT-55456 4

- GB** Drawer insert / Pliers
D Schubladeneinlage / Zangen
PL Wkład do szuflady / Szczypce
RUS Вклад к выдвигному ящику / Клещи
CZ Vložka do zásuvky / Kleště
H Fiókbetét / Fogó készlet
RO Adaos la sertar / Clește
F Module plastique pour servante avec pinces
I Tenone per l'armadio / Pinze
E Accesorio de cajón / Pinzas
CN 钳子托盘组套

PLASTIC TRAY & COLOR LABEL



4
PCS

CrV



180 mm: LONG NOSE;
 160 mm: BENT NOSE

YATO
YT-5534 8

- GB** Drawer insert / Pliers
D Schubladeneinlage / Zangen
PL Wkład do szuflady / Szczypce
RUS Вклад к выдвигному ящику / Клещи
CZ Vložka do zásuvky / Kleště
H Fiókbetét / Zégerfogó készlet
RO Adaos la sertar / Clește
F Module plastique pour servante avec pinces
I Tenone per l'armadio / Pinze
E Accesorio de cajón / Pinzas
CN 挡圈钳托盘组套

PLASTIC TRAY & COLOR LABEL



4
PCS

CrV



180 mm EXTERNAL STRAIGHT; 180 mm INTERNAL STRAIGHT;
 180 mm EXTERNAL BENT; 180 mm INTERNAL BENT

YATO
YT-55443 8

- GB** Drawer insert / Pliers
D Schubladeneinlage / Zangen
PL Wkład do szuflady / Szczypce
RUS Вклад к выдвижному ящику / Клещи
CZ Vložka do zásuvky / Kleště
H Fiókbetét / Fogók
RO Adaos la sertar / Clește
F Module plastique pour servante avec pinces
I Tenone per l'armadio / Pinze
E Accesorio de cajón / Pinzas
CN 钳子托盘组套

PLASTIC TRAY & COLOR LABEL

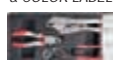

3
PCS

CrMo

CrV



YATO
YT-55463 8

- GB** Drawer insert / Pliers
D Schubladeneinlage / Zangen
PL Wkład do szuflady / Szczypce
RUS Вклад к выдвижному ящику / Клещи
CZ Vložka do zásuvky / Kleště
H Fiókbetét / Fogók
RO Adaos la sertar / Clește
F Module plastique pour servante avec pinces
I Tenone per l'armadio / Pinze
E Accesorio de cajón / Pinzas
CN 钳子托盘组套

PLASTIC TRAY & COLOR LABEL

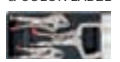

3
PCS

CrMo

CrV

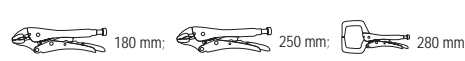

YATO
YT-55472 8

- GB** Drawer insert / Pliers
D Schubladeneinlage / Zangen
PL Wkład do szuflady / Szczypce
RUS Вклад к выдвижному ящику / Клещи
CZ Vložka do zásuvky / Kleště
H Fiókbetét / Fogók
RO Adaos la sertar / Clește
F Module plastique pour servante avec pinces
I Tenone per l'armadio / Pinze
E Accesorio de cajón / Pinzas
CN 钳子托盘组套

PLASTIC TRAY & COLOR LABEL

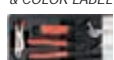

3
PCS

CrMo

CrV



YATO
YT-55473 8

- GB** Drawer insert / Tool set for plumbers
D Schubladeneinlage / Werkzeug-Set für Klempner
PL Wkład do szuflady / Zestaw narzędziowy dla hydraulików
RUS Вклад к выдвижному ящику / Набор инструментов для водопроводчик
CZ Vložka do zásuvky / Sada nářadí pro instalatér
H Fiókbetét / Szerszámkészlet vízvezeték-szerelő
RO Adaos la sertar / Set de instrumente pt. instalator
F Module plastique pour servante / Un ensemble d'outils pour les plombier
I Tenone per l'armadio / Tool set per idraulici
E Accesorio de cajón / Un conjunto de herramientas para fontanero
CN 水管工具组套

PLASTIC TRAY & COLOR LABEL

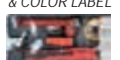

4
PCS

CrV

CrMo

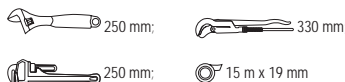

YATO
YT-55480 5

- GB** Drawer insert / Tool set for plumbers
D Schubladeneinlage / Werkzeug-Set für Klempner
PL Wkład do szuflady / Zestaw narzędziowy dla hydraulików
RUS Вклад к выдвижному ящику / Набор инструментов для водопроводчик
CZ Vložka do zásuvky / Sada nářadí pro instalatér
H Fiókbetét / Szerszámkészlet vízvezeték-szerelő
RO Adaos la sertar / Set de instrumente pt. instalator
F Module plastique pour servante / Un ensemble d'outils pour les plombier
I Tenone per l'armadio / Tool set per idraulici
E Accesorio de cajón / Un conjunto de herramientas para fontanero
CN 水管工具组套

PLASTIC TRAY & COLOR LABEL

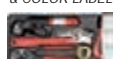

5
PCS

CrV

CrMo

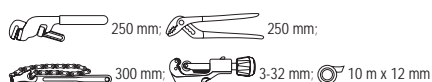

YATO
YT-55481 5

- GB** Drawer insert / Tool set for plumbers
D Schubladeneinlage / Werkzeug-Set für Klempner
PL Wkład do szuflady / Zestaw narzędziowy dla hydraulików
RUS Вклад к выдвижному ящику / Набор инструментов для водопроводчик
CZ Vložka do zásuvky / Sada nářadí pro instalatér
H Fiókbetét / Szerszámkészlet vízvezeték-szerelő
RO Adaos la sertar / Set de instrumente pt. instalator
F Module plastique pour servante / Un ensemble d'outils pour les plombier
I Tenone per l'armadio / Tool set per idraulici
E Accesorio de cajón / Un conjunto de herramientas para fontanero
CN 水管工具组套

PLASTIC TRAY & COLOR LABEL



5
PCS

HSS

8CrB

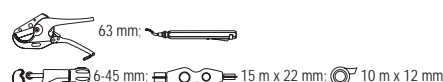

YATO
YT-55482 5

- GB** Drawer insert / Pliers and adjustable wrenches
D Schubladeneinlage / Zangen und rollgabelschlüssel
PL Wkład do szuflady / Szczypce i klucze nastawne
RUS Вклад к выдвижному ящику / Клещи и ключ разводной
CZ Vložka do zásuvky / Kleště, nastavitelný klíč
H Fiókbetét / Fogók és állítható svédkulcs
RO Adaos la sertar / Clește și cheie reglabilă
F Module plastique pour servante / Pincés et clé a molette
I Tenone per l'armadio / Pinze
E Accesorio de cajón / Pinzas y llave ajustable
CN 活络扳手大力钳托盘组套

PLASTIC TRAY & COLOR LABEL



4
PCS

CrMo

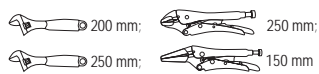

YATO
YT-55444 8

- GB** Drawer insert / Pliers
D Schubladeneinlage / Zangen
PL Wkład do szuflady / Szczypce
RUS Вклад к выдвижному ящику / Клещи
CZ Vložka do zásuvky / Kleště
H Fiókbetét / Fogók
RO Adaos la sertar / Clește
F Module plastique pour servante avec pincés
I Tenone per l'armadio / Pinze
E Accesorio de cajón / Pinzas
CN 钳子托盘组套

PLASTIC TRAY & COLOR LABEL



4
PCS

CrV

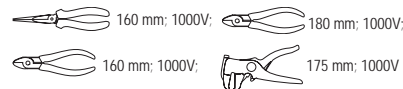

YATO
YT-55464 8

- GB** Drawer insert / Slotted screwdrivers
D Schubladeneinlage / Flachscharuber
PL Wkład do szuflady / Wkrętki płaskie
RUS Вклад к выдвижному ящику / Плоские отвертки
CZ Vložka do zásuvky / Šroubováky ploché
H Fiókbetét / Lapos csavarhúzó
RO Adaos la sertar / Șurubelnițe plane
F Module plastique pour servante avec tournevis
I Tenone per l'armadio / Set di cacciaviti piatti
E Accesorio de cajón / Desarmadores planos
CN 一字螺丝批托盘组套

PLASTIC TRAY & COLOR LABEL



7
PCS

CrMo

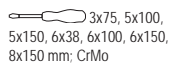

YATO
YT-5535 8

- GB** Drawer insert / Phillips screwdrivers
D Schubladeneinlage / Kreuzschlitzschrauber
PL Wkład do szuflady / Wkrętki krzyżakowe
RUS Вклад к выдвижному ящику / Крестовидные отвертки
CZ Vložka do zásuvky / Šroubováky křížové
H Fiókbetét / Kereszt csavarhúzó
RO Adaos la sertar / Șurubelnițe în cruce
F Module plastique pour servante avec tournevis
I Tenone per l'armadio / Set di cacciaviti a croce
E Accesorio de cajón / Desarmadores de cruz
CN 十字螺丝批托盘组套

PLASTIC TRAY & COLOR LABEL



7
PCS

CrMo

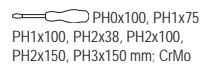

YATO
YT-5536 8

- GB** Drawer insert / Screwdriver set
D Schubladeneinlage / Schraubendrehersatz
PL Wkład do szuflady / Komplet wkrętek
RUS Вклад к выдвижному ящику / Набор отверток
CZ Vložka do zásuvky / Zámečnické šroubováky
H Fiókbetét / Csavarhúzó készlet
RO Adaos la sertar / Șurubelnițe de lăcătușerie
F Module plastique pour servante avec tournevis
I Tenone per l'armadio / Set di cacciaviti
E Accesorio de cajón / Juego de destornilladores
CN 螺丝批托盘组套

PLASTIC TRAY & COLOR LABEL



13
PCS

S2

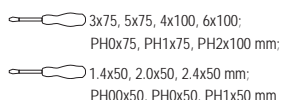

YATO
YT-55455 8

- GB** Drawer insert / Go-through screwdrivers
D Schubladeneinlage / Schlagschrauber
PL Wkład do szuflady / Wkrętki do pobijania
RUS Вклад к выдвижному ящику / Отвертка-било
CZ Vložka do zásuvky / Šroubovák s úderným koncem
H Fiókbetét / Üthető csavarhúzó
RO Adaos la sertar / Șurubelniță pt. fixare
F Module plastique pour servante / Allez - par tournevis
I Tenone per l'armadio / Set di cacciaviti
E Accesorio de cajón / Destornillador para dar golpes
CN 穿心螺丝批托盘组套

PLASTIC TRAY & COLOR LABEL



4
PCS

CrV



YATO
YT-55469 8

- GB** Drawer insert / Screwdriver set
D Schubladeneinlage / Schraubendrehersatz
PL Wkład do szuflady / Komplet wkrętek
RUS Вклад к выдвижному ящику / Набор отвёрток
CZ Vložka do zásuvky / Zámečnické šroubováky
H Fiókbetét / Szigetelt csavarhúzó
RO Adaos la sertar / Şurubelnițe de lăcătuşerie
F Module plastique pour servante avec trounevis
I Tenone per l'armadio / Set di cacciaviti
E Accesorio de cajón / Juego de destornilladores
CN 绝缘螺丝批托盘组套

PLASTIC TRAY & COLOR LABEL



8
PCS

S2



- 3x75, 4x100, 5.5x125, 6.5x150,
PH1x80, PH2x100, PH3x150 mm; 1000V;
4x190 mm; 250V

YATO

YT-55462

8

- GB** Drawer insert / Tool set
D Schubladeneinlage / Sechskant-Steckschlüssel-Satz
PL Wkład do szuflady / Zestaw narzędziowy
RUS Вклад к выдвижному ящику / Набор инструмента
CZ Vložka do zásuvky / Sada nástrčných kľúčů a ráčny
H Fiókbetét / Dugókulcs készlet racsnis hajtókarral
RO Adaos la sertar / Rotruşa chei tubulare cu antrenor
F Module plastique pour servante / Coffret d'outillage
I Tenone per l'armadio / Set di utensili
E Accesorio de cajón / Juego de herramientas
CN 套筒扳手组套

PLASTIC TRAY & COLOR LABEL



4
PCS

CrV



- 3/4" (19.0 mm); (200 mm); CrV 6140;
3/4" (19.0 mm); CrV 50BV30;
3/4" (19.0 mm); (500 mm); 72T; CrV 6140;
3/4" (19.0 mm); (500 mm); CrV 50BV30

YATO

YT-55458

4

- GB** Drawer insert / Socket set
D Schubladeneinlage / Steckschlüsselsatz
PL Wkład do szuflady / Zestaw kluczy nasadowych
RUS Вклад к выдвижному ящику / Торцовые ключи
CZ Vložka do zásuvky / Kľíče nástrčné
H Fiókbetét / Dugókulcsok
RO Adaos la sertar / Duză cheie
F Module plastique pour servante avec set d'outillages
I Tenone per l'armadio chiave a bussola
E Accesorio de cajón / Llaves de cubo
CN 套筒托盘组套

PLASTIC TRAY & COLOR LABEL



22
PCS



- 3/8" (9.5 mm): 6, 7, 8, 9, 10, 11, 12, 13, 14,
15, 16, 17, 18, 19, 20, 21, 22 mm; CrV 50BV30;
3/8" (9.5 mm): (76, 152.4 mm); CrV 50BV30;
3/8" (9.5 mm); CrV 50BV30;
3/8" (9.5 mm); (200 mm); 72T; CrV 6140;
3/8" (9.5 mm); (198 mm); CrV 50BV30

YATO

YT-5542

8

- GB** Drawer insert / Socket set
D Schubladeneinlage / Steckschlüsselsatz
PL Wkład do szuflady / Zestaw kluczy nasadowych
RUS Вклад к выдвижному ящику / Торцовые ключи
CZ Vložka do zásuvky / Kľíče nástrčné
H Fiókbetét / Dugókulcsok
RO Adaos la sertar / Duză cheie
F Module plastique pour servante avec set d'outillages
I Tenone per l'armadio chiave a bussola
E Accesorio de cajón / Llaves de cubo
CN 套筒托盘组套

PLASTIC TRAY & COLOR LABEL



25
PCS

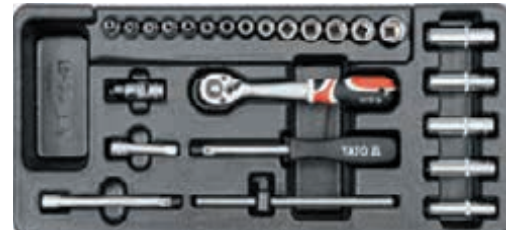

- 1/4" (6.3 mm): 3.5, 4, 4.5, 5, 5.5, 6, 7, 8, 9, 10, 11, 12, 13, 14 mm; CrV 50BV30;
1/4" (6.3 mm): 8, 10, 11, 12, 13 mm; CrV 50BV30;
1/4" (6.3 mm): (50.8, 101.6 mm); CrV 6140;
1/4" (6.3 mm); CrV 50BV30;
1/4" (6.3 mm); (155 mm); 72T; CrV 6140;
1/4" (6.3 mm); (152.4 mm); CrV 50BV30

YATO

YT-5541

8

- GB** Drawer insert / Socket set
D Schubladeneinlage / Steckschlüsselsatz
PL Wkład do szuflady / Zestaw kluczy nasadowych
RUS Вклад к выдвижному ящику / Торцовые ключи
CZ Vložka do zásuvky / Kľíče nástrčné
H Fiókbetét / Dugókulcsok
RO Adaos la sertar / Duză cheie
F Module plastique pour servante avec set d'outillages
I Tenone per l'armadio chiave a bussola
E Accesorio de cajón / Llaves de cubo
CN 套筒托盘组套

PLASTIC TRAY & COLOR LABEL



24
PCS



- 1/2" (12.7 mm): 10, 11, 12, 13, 14, 15, 16,
17, 18, 19, 20, 21, 22, 23, 24,
27, 30, 32 mm; CrV 50BV30;
1/2" (12.7 mm); (127 mm); CrV 50BV30;
1/2" (12.7 mm); CrV 50BV30;
1/2" (12.7 mm); (255 mm); 72T; CrV 6140;
1/2" (12.7 mm); (255 mm); CrV 50BV30;
1/2" (12.7 mm); 16; 21 mm; CrV 50BV30

YATO

YT-5537

4

- GB** Drawer insert / Screwdriver bits
D Schubladeneinlage / Endstücke für Schraubenzieher
PL Wkład do szuflady / Końcówki śrubokrętowe
RUS Вклад к выдвижному ящику / Насадки для отвёрток
CZ Vložka do zásuvky / Šroubovací nástavce
H Fiókbetét / Csavarhúzó bitek
RO Adaos la sertar / Terminații pt. şurubelnițe
F Module plastique pour servante avec set d'embouts
I Tenone per l'armadio chiave punti di avvitamento
E Accesorio de cajón / Puntas para desarmadores
CN 旋具头托盘组套

PLASTIC TRAY & COLOR LABEL



40
PCS



- H4, H5, H6, H7, H8, H10, H12 (L=30 mm); H4, H5, H6, H7, H8, H10, H12 (L=75 mm); AISI S2; M5, M6, M8, M10, M12 (L=30 mm); M5, M6, M8, M10, M12 (L=75 mm); AISI S2; T20, T25, T30, T40, T45, T50, T55 (L=30 mm); T20, T25, T30, T40, T45, T50, T55 (L=75 mm); AISI S2; 1/2" (12.7 mm), 3/8" (9.5 mm)

YATO

YT-5538

8

- GB** Drawer insert / Socket set
D Schubladeneinlage / Steckschlüsselsatz
PL Wkład do szuflady / Zestaw kluczy nasadowych
RUS Вклад к выдвижному ящику / Торцовые ключи
CZ Vložka do zásuvky / Klíče nástrčné
H Fiókbetét / Dugókulcs készlet
RO Adaos la sertar / Duză cheie
F Module plastique pour servante avec set d'outillages
I Tenone per l'armadio chiave a bussola
E Accesorio de cajón / Llaves de cubo
CN 套筒托盘组套

PLASTIC TRAY & COLOR LABEL



14 PCS

CrV 50BV30



3/4" (19.0 mm): 19, 21, 22, 24, 27, 28, 30, 32, 34, 36, 41, 46, 50, 55 mm

YATO
YT-55457 4

- GB** Drawer insert / Deep sockets
D Schubladeneinlage / Tiefe Steckschlüssel
PL Wkład do szuflady / Klucze nasadowe długie
RUS Вклад к выдвижному ящику / Торцовые глубокие ключи
CZ Vložka do zásuvky / Klíče nástrčné hluboké
H Fiókbetét / Hosszú dugókulcsok
RO Adaos la sertar / Prize de curent adânci
F Module plastique pour servante avec set de douilles
I Tenone per l'armadio chiave a bussola lunghe
E Accesorio de cajón / Llaves de cubo profundo
CN 六角长套筒托盘组套

PLASTIC TRAY & COLOR LABEL



14 PCS

CrV 50BV30



1/2" (12.7 mm): 8, 9, 10, 11, 12, 13, 14, 15, 16, 17, 18, 19, 20, 21 mm (L=76 mm); CrV 50BV30

YATO
YT-5539 8

- GB** Drawer insert / Tool set
D Schubladeneinlage / Sechskant-Steckschlüssel-Satz
PL Wkład do szuflady / Zestaw narzędziowy
RUS Вклад к выдвижному ящику / Набор инструментов
CZ Vložka do zásuvky / Sada nástrčných klíčů a ráčny
H Fiókbetét / Dugókulcs készlet
RO Adaos la sertar / Rotrusa chei tubulare cu antrenor
F Module plastique pour servante / Coffret d'outillage
I Tenone per l'armadio / Set di utensili
E Accesorio de cajón / Juego de herramientas
CN 套筒扳手组套

PLASTIC TRAY & COLOR LABEL



31 PCS

CrV

S2



1/2" (12.7 mm): E10, E12, E14, E16, E18, E20 (L=38 mm); CrV 50BV30;
 M5, M6, M8, M10, M12 (L=30 mm); AISI S2;
 1/2" (12.7 mm): 10 mm; CrV 6150;
 2, 2.5, 3, 4, 5, 6, 7, 8, 10, 12 mm; CrV 6150;
 T10, T15, T20, T25, T27, T30, T40, T45, T50; CrV 6150

YATO
YT-55451 8

- GB** Drawer insert / Hammers and chisels
D Schubladeneinlage / Hämmer und Meißel
PL Wkład do szuflady / Molotki i przecinaki
RUS Вклад к выдвижному ящику / Молотки и зубила
CZ Vložka do zásuvky / Kladiva, dláta a sekáče
H Fiókbetét / Kalapácsok és hidegvágók
RO Adaos la sertar / Ciocane și dălți
F Module plastique pour servante avec marteaux et burins
I Tenone per l'armadio martelli e scalpelli
E Accesorio de cajón / Martillos y cinceles
CN 锤头凿子托盘组套

PLASTIC TRAY & COLOR LABEL

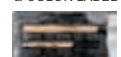

5 PCS

CrV



300 g (L=300 mm);
 40 mm (L=350 mm);
 10x8x142 mm,
 12x10x152 mm, 16x13x172 mm

YATO
YT-5540 8

- GB** Drawer insert / Measuring tools
D Schubladeneinlage / Messwerkzeuge
PL Wkład do szuflady / Narzędzia miernicze
RUS Вклад к выдвижному ящику / Измерительные приборы
CZ Vložka do zásuvky / Měřeni
H Fiókbetét / Mérészközök
RO Adaos la sertar / Instrumente de măsură
F Module plastique pour servante / Outils de mesurage
I Tenone per l'armadio / Strumenti di misura
E Accesorio de cajón / Instrumentos de medición
CN 量具托盘组套

PLASTIC TRAY & COLOR LABEL



5 PCS



300 mm; 0-150 mm;
 2 m;
 3m x 16 mm; 0.02-1.00 mm

YATO
YT-55474 8

- GB** Drawer insert / Steel file set
D Schubladeneinlage / Werkstatt-feilen
PL Wkład do szuflady / Pilniki do metalu
RUS Вклад к выдвижному ящику / Набор напильников слесарных
CZ Vložka do zásuvky / Zámečnické pilníky
H Fiókbetét / Lakatos reszelő
RO Adaos la sertar / Pile de lăcătușerie
F Module plastique pour servante / Fichier steel ensemble
I Tenone per l'armadio / File di metallo
E Accesorio de cajón / Juego de limas para metal
CN 锉刀托盘组套

PLASTIC TRAY & COLOR LABEL



5 PCS

T12 STEEL



#2 200 mm;
 #2 200 mm;
 #2 200 mm;
 #2 200 mm;
 #2 200 mm

YATO
YT-55453 8

- GB** Drawer insert / Hand riveter with rivets
D Schubladeneinlage / Blindnietzange
PL Wkład do szuflady / Nitownica ręczna z głowicą obrotową
RUS Вклад к выдвижному ящику / Заклепочник
CZ Vložka do zásuvky / Ruční nýtovačka
H Fiókbetét / Kézi popszegeshűző
RO Adaos la sertar / Pclește pt. popnituri
F Module plastique pour servante / Riveteuse a main
I Tenone per l'armadio / Rivettatrice manuale girevole
E Accesorio de cajón / Remachadora de mano
CN 手动铆钉枪及铆钉托盘组套

PLASTIC TRAY & COLOR LABEL



6
PCS

CrMo



2.4, 3.2, 4.0, 4.8 mm;
9.6x3.2, 9.6x4.0, 12.7x4.0, 9.6x4.8, 12.7x4.8 mm

YATO
YT-55466 8

- GB** Drawer insert / Tool set
D Schubladeneinlage / Sechskant-Steckschlüssel-Satz
PL Wkład do szuflady / Zestaw narzędziowy
RUS Вклад к выдвижному ящику / Набор инструмента
CZ Vložka do zásuvky / Sada nástrčných klíčů a ráčny
H Fiókbetét / Dugókulcs készlet racsnis hajtókarral
RO Adaos la sertar / Rotrusa chei tubulare cu antrenor
F Module plastique pour servante / Coffret d'outillage
I Tenone per l'armadio / Set di utensili
E Accesorio de cajón / Juego de herramientas
CN 套筒扳手组套

PLASTIC TRAY & COLOR LABEL



6
PCS

CrMo

CrV



1" (25 mm), L=330 mm;
250 mm;

2.4, 3.2, 4.0, 4.8 mm;

9.6x3.2, 9.6x4.0, 12.7x4.8 mm

YATO
YT-55478 8

- GB** Drawer insert / Automotive workshop tools
D Schubladeneinlage / Kfz-werkzeuge
PL Wkład do szuflady / Zestaw narzędzi warsztatowych
RUS Вклад к выдвижному ящику / Автомобильные инструменты
CZ Vložka do zásuvky / Auto nářadí
H Fiókbetét / Autóipari szerszámok
RO Adaos la sertar / Scule auto
F Module plastique pour servante / Outils de réparation automobile
I Tenone per l'armadio / Set attrezzi officina
E Accesorio de cajón / Herramientas de automoción
CN 轮胎修理工具托盘组套

PLASTIC TRAY & COLOR LABEL



5
PCS

CrV



200 mm; 135 mm;
300, 400, 500 mm

YATO
YT-55477 4

- GB** Drawer insert / Automotive workshop tools
D Schubladeneinlage / Kfz-werkzeuge
PL Wkład do szuflady / Zestaw narzędzi warsztatowych
RUS Вклад к выдвижному ящику / Автомобильные инструменты
CZ Vložka do zásuvky / Auto nářadí
H Fiókbetét / Autóipari szerszámok
RO Adaos la sertar / Scule auto
F Module plastique pour servante / Outils de réparation automobile
I Tenone per l'armadio / Set attrezzi officina
E Accesorio de cajón / Herramientas de automoción
CN 轮胎修理工具托盘组套

PLASTIC TRAY & COLOR LABEL



10
PCS

CrV



1/2" (12.7 mm) x 5/16" (7.9 mm);
PH3 (L=35 mm); PH1, PH2, PH3 (L=75 mm);
8 mm (L=35 mm); 8 mm (L=75 mm);

12-38 mm; 3" (75 mm); 82 mm

YATO
YT-55476 4

- GB** Drawer insert / Tool set
D Schubladeneinlage / Sechskant-Steckschlüssel-Satz
PL Wkład do szuflady / Zestaw narzędziowy
RUS Вклад к выдвижному ящику / Набор инструмента
CZ Vložka do zásuvky / Sada nástrčných klíčů a ráčny
H Fiókbetét / Dugókulcs készlet racsnis hajtókarral
RO Adaos la sertar / Rotrusa chei tubulare cu antrenor
F Module plastique pour servante / Coffret d'outillage
I Tenone per l'armadio / Set di utensili
E Accesorio de cajón / Juego de herramientas
CN 套筒扳手组套

PLASTIC TRAY & COLOR LABEL

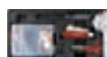

23
PCS



140 mm; 200 mm;
19 mm x 20 mm; 4x190 mm; 250 V;
1.0, 1.5, 2.0, 2.5, 3.0, 3.5, 4.0, 4.5, 5.0, 5.5,
6.0, 6.5, 7.0, 7.5, 8.0, 8.5, 9.0, 9.5, 10.0 mm

YATO
YT-55471 8

- GB** Drawer insert / Taps and die set
D Schubladeneinlage / Gewindeschneidwerkzeug-satz
PL Wkład do szuflady / Zestaw narzynek i gwintowników
RUS Вклад к выдвижному ящику / Набор плашек и метчиков
CZ Vložka do zásuvky / Souprava závitníků a kruhových závitových čelistí
H Fiókbetét / Menetfűrés és menetvágó készlet
RO Adaos la sertar / Set de tarozi și filiere
F Module plastique pour servante / Pince a riveter avec embouts
I Tenone per l'armadio / Set di filiera a maschi
E Accesorio de cajón / Juego de machos de roscar y cojinetes
CN 丝锥板牙托盘组套

PLASTIC TRAY & COLOR LABEL



35
PCS

HCS



3x: M3x0.5, M4x0.7, M5x0.8, M6x1.0, M7x1.0, M8x1.25,
M10x1.5, M12x1.75; M3x0.5, M4x0.7, M5x0.8, M6x1.0, M7x1.0, M8x1.25,
M10x1.5, M12x1.75; 0.5 - 1.75 mm; 27G; 28G;
M7-M9; M3-M12

YATO
YT-55465 8

- GB** Drawer insert
- D** Schubladeneinlage
- PL** Wkład do szuflady
- RUS** Вклад к выдвижному ящику
- CZ** Vložka do zásuvky
- H** Fiókbetét
- RO** Adaos la sertar
- F** Module plastique pour servante
- I** Tenone per l'armadio
- E** Accesorio de cajón
- CN** 吸塑盒



for / dla: YT-5531

YATO	
YT-55311	5/30



for / dla: YT-5532

YATO	
YT-55321	5/30



for / dla: YT-5533

YATO	
YT-55331	5/30

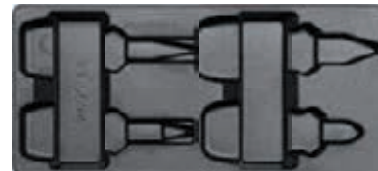

for / dla: YT-5534

YATO	
YT-55341	5/30

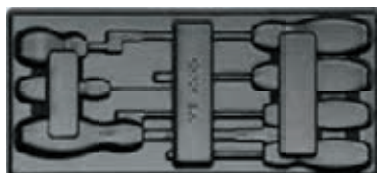

for / dla: YT-5535

YATO	
YT-55351	5/30

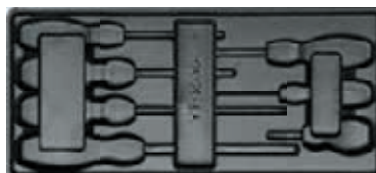

for / dla: YT-5536

YATO	
YT-55361	5/30



for / dla: YT-5537

YATO	
YT-55371	5/30

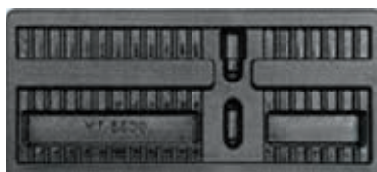

for / dla: YT-5538

YATO	
YT-55381	5/30



for / dla: YT-5539

YATO	
YT-55391	5/30



for / dla: YT-5540

YATO	
YT-55401	5/30



for / dla: YT-5541

YATO	
YT-55411	5/30



for / dla: YT-5542

YATO	
YT-55421	5/30



for / dla: YT-55454

YATO	
YT-55479	5/30

16

- GB** Legs for workbench, long
- D** Beine für Werkbank, lange
- PL** Nogi do stołu warsztatowego, długie
- RUS** Ножи для верстака, длинные
- CZ** Nohy k pracovnímu stolu, dlouhé
- H** Lábak munkapadhoz
- RO** Picioare pt. banc de lucru, lungi
- F** Jambes pour table d'atelier
- I** Gambe del tavolo piedi del banco da lavoro
- E** Patas para banco de trabajo, largas
- CN** 工作台长桌腿



2
PCS

140
cm

WHITE
CARTON BOX
& COLOR LABEL

for / dla: YT-08920

YATO	size / rozmiar (cm)	
YT-08921	140	2

- GB** Holders for workshop box
- D** Halterungen für die Montage eines Werkstattschranks
- PL** Uchwyty do montażu szafki warsztatowej
- RUS** Крепеж для рабочего шкафа
- CZ** Montážní držáky dílenské skříňky
- H** Műhelyszekrény tartó
- RO** Suporturi pt. montarea dulapului de atelier
- F** Porte-placard d'atelier
- I** Staffa di montaggio per armadio portautensili
- E** Elementos de fijación para instalación de cajón de taller
- CN** 工具柜安装挂板



2
PCS

500x100
x350 mm

WHITE
CARTON BOX
& COLOR LABEL

for / dla: YT-08920, YT-09152

YATO	size / rozmiar (mm)	
YT-08922	500x100x350	2

- GB** Connection steel pipes set
D Anschluss Stahlrohre Gesetzt
PL Rury montażowe
RUS Стальная труба монтаж
CZ Ocelové trubky
H Acélsövek
RO Tevi din oțel
F Tuyaux en acier
I Set di montaggio per tabella utensili
E Tubos de acero
CN 工具柜连接杆





POLYBAG

2
PCS

48.5
x \varnothing 2.8 cm

for / dla:
YT-09152
YT-09155
+
YT-0902
YT-0903
YT-0904



YATO 	size / rozmiar (cm)	
YT-09071	48.5 x \varnothing 2.8	20

- GB** Double project center backwall
D Werkzeugwand
PL Tablica narzędziowa
RUS Доска инструмент
CZ Držáky na nářadí
H Szerszámtartó fal akasztókkal
RO Suport perete scule
F Mur d'outil
I La tabella utensili
E Panel de herramientas
CN 工具车双挂板





POLYBAG

2
PCS

65.2 x 61
x 5.5 cm





for / dla:
YT-0902 YT-55290
YT-0903 YT-55292
YT-09031 YT-55293
YT-0904 YT-5530

YATO 	size / rozmiar (cm)	
YT-09072	65.2x61x5.5	2

- GB** Compartmented shelf and paper roll holder
D Werkstattwagenab-lage mit Papierrollehalter
PL Półka z uchwytem na papier
RUS Полка с держателем для бумаги
CZ Police s úchytem na papír
H Kiegészítő polc és papírröli tartó funkcióval
RO Compartiment pt. dulap si suport hartie
F Support rouleau papier
I Mensola portarotoli carta
E Estante con sujetapapel
CN 托架



for / dla: YT-0902, YT-0903, YT-0904, YT-0905

YATO 	size / rozmiar (mm)	
YT-0907	305x305x145	4

- GB** Dustbin
D Abfalleimer
PL Pojemnik na odpady
RUS Мусорный ящик
CZ Zásobník na odpad
H Szemétkosár
RO Lada de gunoi
F Poubelle
I Contenitore di rifiuti
E Cubo de basura
CN 废品箱





for / dla: YT-0902, YT-0903, YT-0904, YT-0905

YATO 	size / rozmiar (mm)	
YT-0908	300x300x190	4

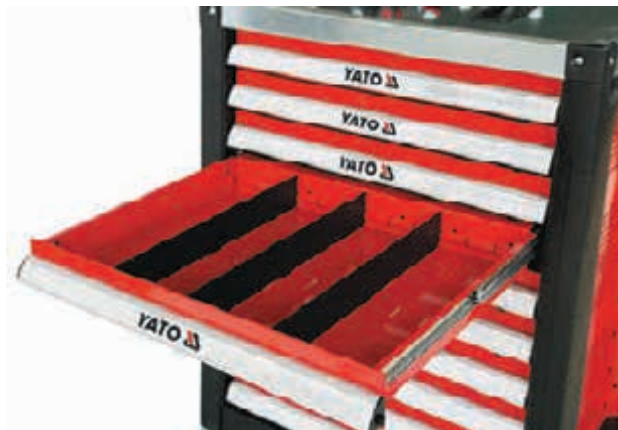
- GB** Separate board for drawer
D Trennsteg für Werkstatt-Wagen-Schublade
PL Przegroda do szafki
RUS Перегородки для ящика
CZ Příkladka do police
H Több rekeszes tálcá
RO Sertar separat de masura mica
F Cloison tiroir court
I Separatore per armadio
E Separador para armario
CN 抽屉分隔板



for / dla: YT-0902, YT-0903, YT-0904, YT-0905

YATO 	size / rozmiar (mm)	
YT-0910	391x58x4	30
YT-0911	391x128x4	24



GB Tool box
D Werkzeugkasten
PL Skrzynka narzędziowa
RUS Инструментальный ящик
CZ Skříňka na nářadí
H Szerszámos láda

RO Cutie de scule
F Boîte à outils
I Cassetta degli attrezzi
E Caja de herramientas
CN 工具箱

WHITE
 CARTON BOX
 & COLOR LABEL

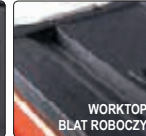





390x215x130 mm
 max 10 kg



390x215x60 mm
 max 5 kg

390x215x60 mm
 max 5 kg

YATO 	drawers / szuflady	
YT-09108	1	2

YATO 	drawers / szuflady	
YT-09107	2	2

GB Tool trolley
D Werkzeugkasten
PL Wózek narzędziowy 3-częściowy
RUS Тележка инструментальная
CZ Vozík na nářadí
H Szerszám kocsi
RO Instrument cărucior
F Servante d'atelier
I Armadio per utensili
E Herramienta carro
CN 工具箱



WHITE
 CARTON BOX
 & COLOR LABEL

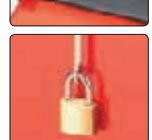
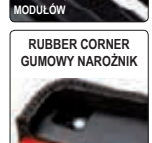
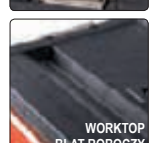

420x220x150 mm
 max 20 kg

390x215x130 mm
 max 10 kg

410x210x280 mm
 max 15 kg

420x220x150 mm
 max 20 kg

390x215x60 mm
 max 5 kg

410x210x280 mm
 max 15 kg



YATO 		
YT-09102		1

YATO 		
YT-09101		1

GB Cantilever tool box
D Werkzeugkoffer
PL Skrzynka narzędziowa
RUS Инструментальный ящик

CZ Nástrojová skříňka
H Szerszámosláda
RO Cutie pt. scule
F Boîte à outils

I Cassetta degli attrezzi
E Caja de herramientas
CN 工具箱

WHITE
CARTON
BOX
& COLOR
LABEL



YATO	size / rozmiar (mm)	
YT-0882	360x150x115	4

YATO	size / rozmiar (mm)	
YT-0883	428x180x180	1

YATO	size / rozmiar (mm)	
YT-0884	460x200x180	1



YATO	size / rozmiar (mm)	
YT-0885	460x200x225	1

YATO	size / rozmiar (mm)	
YT-0886	510x220x240	1

GB Tool box with tools
D Werkzeugkoffer
PL Skrzynka z narzędziami
RUS Инструментальный ящик
CZ Nástrojová skříňka
H Szerszámosláda

RO Cutie pt. scule
F Boîte d'outils
I Cassetta degli attrezzi
E Caja de herramientas
CN 工具组套

62 PCS	1/2" 12.5mm	CrV 50BV30	CrV 6150	CrV 6140
72T	AS-DRIVE	⊖	⊕	



- 1/2" (12.7 mm): 10, 11, 12, 13, 14, 15, 16, 17, 18, 19, 20, 21, 22, 23, 24 mm (L=38 mm); 27, 30, 32 mm (L=42 mm); CrV 50BV30;
- 1/2" (12.7 mm): (76, 127, 254 mm); CrV 50BV30;
- 1/2" (12.7 mm): CrV 50BV30;
- 1/2" (12.7 mm): 21 mm; CrV 50BV30;
- 1/2" (12.7 mm): (255 mm); CrV 50BV30;
- 1/2" (12.7 mm): 72T; CrV 6140;
- 1/2" (12.7 mm): (450 mm); CrV 50BV30;
- 6, 7, 8, 9, 10, 11, 12, 13, 14, 15, 16, 17, 18, 19, 20, 21, 22, 24 mm; CrV;
- 6x100, 6x150, 8x200 mm; CrV 6150;
- PH2x100, PH3x150, PH3x200 mm; CrV 6150;
- 180 mm; CrV; 160 mm; CrV;
- 1.5, 2, 2.5, 3, 4, 5, 6, 8, 10 mm; CrV 6150

WHITE
CARTON
BOX
& COLOR
LABEL



YATO	size / rozmiar (mm)	
YT-3895	475x230x365	1

GB Tool box with tools **RUS** Инструментальный ящик **RO** Cutie pt. scule **E** Caja de herramientas
D Werkzeugkoffer **CZ** Nástrojová skříňka **F** Boîte d'outils **CN** 工具组套
PL Skrzynka z narzędziami **H** Szerszámoszláda **I** Cassetta degli attrezzi

80 PCS	1/2" 12.5mm	1/4" 6.3mm	CrV 50BV30	CrV 6140
S2	72T	AS-DRIVE	⊖	⊕



- 1/2" (12.7 mm): 10, 11, 12, 13, 14, 15, 17, 19 mm (L=38 mm);
- 1/4" (6.3 mm): 5, 6, 7, 8, 9, 10, 11, 12, 13 mm (L=25 mm); CrV 50BV30;
- 1/2" (12.7 mm): 21 mm; CrV 50BV30;
- 1/2" (12.7 mm): (255 mm); 72T; CrV 6140;
- 1/4" (6.3 mm): (150 mm); CrV 50BV30;
- 1/4" (6.3 mm) x 1/4" (6.3 mm); CrV 50BV30;
- 1/4" (6.3 mm): 3 (x2), 4 (x2), 5 (x2), 5.5 (x2), 6 (x2) mm (L=25 mm); AISI S2;
- 1/4" (6.3 mm): PH0, PH1 (x2), PH2 (x2), PH3 (L=25 mm); AISI S2;
- 1/4" (6.3 mm): PZ0, PZ1 (x2), PZ2 (L=25 mm); AISI S2;
- 6, 7, 8, 9, 10, 11, 12, 13, 14, 15, 17, 19 mm; CrV;
- 5x75 mm, 6x100 mm, 8x150 mm, PH1x75 mm, PH2x100 mm; S2;
- 180 mm; CrV; 160 mm; CrV; 160 mm; CrV;
- 250 mm; 300 g; 18 mm; SK2; 18x0.5 mm; SK2;
- 1.5, 2, 2.5, 3, 4, 5, 5.5, 6 mm; T10, T15, T20, T25, T27, T30, T40; CrV

WHITE
CARTON
BOX
& COLOR
LABEL



YATO	size / rozmiar (mm)	
YT-38951	460x220x245	1

GB Oil filter wrench
D Ölfilterschlüssel
PL Klucz do filtra oleju
RUS Ключ к масляному фильтру
CZ Klíč na olejový filtr
H Olajszűrő leszedő
RO Cheie pt. filtru de ulei
F Clé au filtre d'huile
I Chiave per filtro olio
E Llave para el filtro de aceite
CN 滤清器扳手



SLIDING
CARD



YATO	Ø (mm)	
YT-0820	60-73	12/48
YT-0821	73-85	12/48
YT-0822	85-95	12/48
YT-0823	95-111	12/48

GB Belt oil wrench
D Ölfilterschlüssel mit Riemen
PL Klucz taśmowy do filtrów oleju
RUS Ключ тросовый для масляных фильтров
CZ Klíč na olejové filtry
H Olajszűrő leszedő
RO Cheie filtru cu banda
F Clé au filtre d'huile
I Chiave a nastro per filtro olio
E Llave de cinta para filtros de aceite
CN 皮帶鉗扳手



BLISTER
CARD



YATO	Ø (mm)	
YT-0824	80-160	6/60
YT-0825	100-200	5/20

- GB Oil filter wrench
- D Ölfilterschlüssel
- PL Klucz do filtra oleju
- RUS Съёмник масляных фильтров
- CZ Klíč na filtr oleju řetezový
- H Olajszűrő leszedő, 3 kórmós
- RO Cheie filtru ulei cu lanț
- F Clé au filtre d'huile
- I Chiave per filtro olio
- E Llave do filtro de cadenta
- CN 滤清器扳手



COLOR BOX



63-120 mm 2.5-4"	3/8" 10.0 mm	1/2" 12.5 mm
HRC 40-50	CrV	

YATO	
YT-0826	12/36

- GB Cap type oil filter wrench set
- D Steckschlüsselsatz für den Ölfilter
- PL Zestaw kluczy nasadowych do filtra oleju
- RUS Набор торцовых ключей к масляному фильтру
- CZ Sada miskovitých klíčů na olejové filtry
- H Dugókulcs készlet olajszűrőhöz
- RO Set de chei tubulare pt. filtru de ulei
- F Set d'embouts aux filtres d'huile
- I Set di chiavi filtro olio
- E Juego de llaves de tubo para el filtro de aceite
- CN 碗型滤清器扳手组套



15
PCS

FIBRE
REINFORCED
POLYMER

3/8"
10mm

BMC
& COLOR
SLEEVE



YATO		
YT-0595	3/8" (9.5 mm)	5

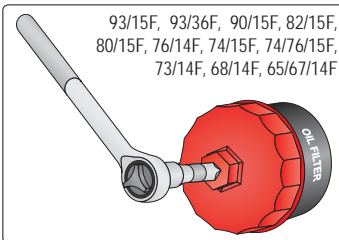

93/15F, 93/36F, 90/15F, 82/15F,
80/15F, 76/14F, 74/15F, 74/76/15F,
73/14F, 68/14F, 65/67/14F

- GB Cap type oil filter wrench set
- D Steckschlüsselsatz für den Ölfilter
- PL Zestaw kluczy nasadowych do filtra oleju
- RUS Набор торцовых ключей к масляному фильтру
- CZ Sada miskovitých klíčů na olejové filtry
- H Dugókulcs készlet olajszűrőhöz

- RO Set de chei tubulare pt. filtru de ulei
- F Set d'embouts aux filtres d'huile
- I Set di chiavi filtro olio
- E Juego de llaves de tubo para el filtro de aceite
- CN 碗型滤清器扳手组套

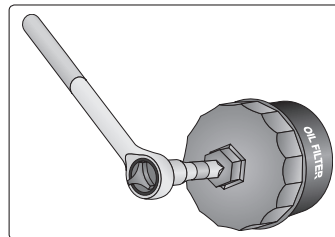

13 PCS	3/8" 10mm	1/2" 12.5mm	65-120 mm
-----------	--------------	----------------	--------------



BMC
& COLOR
SLEEVE



YATO	number	size	layers	grooves	faces	car models	
	number	rozmiar	warstwy	bruzdy	powierzchnie	modele samochodu	
YT-0594	66/6	SW66	1	6		Fiat Punto 1.2, Renault Clio 1.2, Rapid, Twingo	5
	76/8	SW76	1	8		Fiat, Lancia	
	76/12	SW76	1		12	Fiat, Mercedes, Renault	
	86/16	SW86	1		16	Volvo	
	86/18	SW86	1		18	VW Golf, Audi A6 TDI, Peugeot, Citroen	
	92/10	SW92	1		10	Fiat	
	93/45	SW93	1	45		VW, Audi TDI	
	96/18	SW96	1	18		Audi A4, A6 TDI, VQ Passat TDI, Renault Laguna	
	106/15	SW106	1		15	Fiat Ducato	
	108/15	SW108	1		15	Volvo	
	108/18	SW108	1	18		Renault Espace, Laguna, Safrane, Traffic	

GB Cap type oil filter wrench set
D Steckschlüsselsatz für den Ölfilter
PL Zestaw kluczy nasadowych do filtra oleju
RUS Набор торцовых ключей к масляному фильтру
CZ Sada miskovitých klíčů na olejové filtry
H Dugókulcs készlet olajsűrőhöz

RO Set de chei tubulare pt. filtru de ulei
F Set d'embouts aux filtres d'huile
I Set di chiavi filtro olio
E Juego de llaves de tubo para el filtro de aceite
CN 碗型滤清器扳手组套

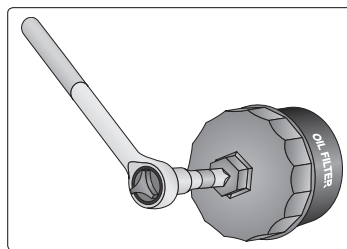

30
PCS
3/8"
10mm

BMC & COLOR SLEEVE



YATO number	size rozmiar	layers warstwy	grooves bruzdy	faces powierzchnie	car models modele samochodů
66/6	SW66	1	6		Fiat Punto 1.2, Renault Clio 1.2, Rapid, Twingo
65/14	SW65	1		14	Daihatsu, Toyota, Nissan, Fiat
65/67	SW65-67	1		14	Daihatsu, Toyota
68/14	SW68	1		14	Mazda, Ford, Subaru
73/14	SW73	1		14	Toyota, Lexus
74/15	SW74	1		15	Audi, Rover, Chrysler
74/76	SW74-76	2		15	Ford, Opel, VW, Audi, Mercedes
75/77	SW75-77	2		15	VW, Audi, Isuzu, Mercedes
76/12	SW76	1		12	Fiat, Mercedes, Renault
76/14	SW76	1		14	VW, Porsche, Mercedes, BMW, Audi, Opel
76/30	SW76	1	30		Ford
76/8	SW76	1	8		Fiat, Lancia
78/15	SW78	1		15	Nissan, Ford, Toyota
80/15	SW80	1		15	Nissan, Honda, Opel, Mazda
80/82	SW80-82	2		15	Subaru, Toyota, Honda, Nissan
86/16	SW86	1		16	Volvo
86/18	SW86	1		18	VW Golf, Audi A6 TDI, Peugeot, Citroen
90/15	SW90	1		15	Honda, Mitsubishi, Isuzu
92/10	SW92	1		10	Fiat
93/15	SW93	1		15	Mazda, Volvo, Mitsubishi, Nissan, Honda
93/36	SW93	1	36		Ford
93/45	SW93	1	45		VW, Audi TDI
95/15	SW95	1		15	Toyota, Alfa Romeo, Ford
96/18	SW96	1		18	Audi A4, A6 TDI, VQ Passat TDI, Renault Laguna
100/15	SW100	1		15	Isuzu, Mitsubishi
106/15	SW106	1		15	Fiat Ducato
108/15	SW108	1		15	Volvo
108/18	SW108	1	18		Renault Espace, Laguna, Safrane, Traffic

GB Oil filter sockets
D Aufsätze für die Ölfilter
PL Zestaw nasadek do filtrów oleju
RUS Набор насадок к масляным фильтрам
CZ Sada nástavců na olejové filtry
H Olajsűrő leszedő készlet
RO Set de cartușe pt. filtre de ulei
F Set d'embouts aux filtres d'huile
I Set di chiavi filtro olio
E Juego de tapones para los filtros de aceite
CN 滤油器套筒组套



4
PCS
3/8"
10mm

27 32
36 38 mm

CrV AS-DRIVE

BMC & COLOR SLEEVE



YATO YT-0598 3/8" (9.5 mm) 20

GB Oil drain plug set
D Ölablassschrauben Schlüsselsatz
PL Komplet kluczy do korków oleju
RUS Комплект ключей для сливной пробки
CZ Klíče nástrčné na zátky olejových van motorů
H Olajleeresztő kulcs készlet

RO Set bituri pt. bujon ulei
F Ensemble de clés de bouchon de vidange d'huile
I Set di chiavi a bussola
E Juego de llaves para tapones de aceite
CN 排油塞旋具组套

18
PCS
3/8"
10mm

7 8 10 11 12
13 14 mm

8 9 10 12
14 17 mm

5/16" 3/8" 10 mm CrV



□ 7, 8, 10, 11, 12, 13, 14 mm;
 ○ 8, 9, 10, 12, 14, 17 mm;
 □ 5/16" (8 mm), 3/8" (10 mm);
 △ 10 mm; 10 mm;
 → 160 mm

BMC & COLOR SLEEVE



YATO YT-0599 3/8" (9.5 mm) 10

GB Oil drain plug set
D Ölablassschrauben Schlüsselsatz
PL Komplet kluczy do korków oleju
RUS Комплект ключей для сливной пробки
CZ Klíče nástrčné na zátky olejových van motorů

H Olajleeresztő kulcskészlet
RO Set bituri pt. bujon ulei
F Set de clés à vindage d'huile
I Set di chiavi per tappi olio
E Juego de llaves para tapones de aceite
CN 排油塞旋具组套

12
PCS
3/8"
10mm

(mm) 3/8" 3/8" 8 9
8 11 13 10 12 14 17



BMC & COLOR SLEEVE



YATO YT-0600 10

- GB** Oil pan thread repair set
D Reparatursatz für Verschlussstopfen von Ölwanne
PL Zestaw naprawczy korków do miski olejowej
RUS Набор для ремонта масляных пробок
CZ Souprava na opravu vuroůstých šroubů olejových van
H Olajleknő-csavar javítókészlet
RO Set pt. reparare dopuri baie de ulei

- F** Kit réparation de bouchons de carter d'huile
I Set per riparazione dei tappi della coppa del olio
E Juego de reparación para los tapones del cárter de aceite
CN 螺纹修复组套



64
PCS **CrMo**

M13		M13		13 mm	
		5 pcs		10 pcs	
M15		M15		15 mm	
		5 pcs		10 pcs	
M17		M17		17 mm	
		5 pcs		10 pcs	
M20		M20		20 mm	
		5 pcs		10 pcs	



YATO
YT-1757

- GB** Lever action grease gun with rigid spout
D Handhebel-Fettpresse
PL Smarownica ręczna z końcówką sztywną
RUS Шприц для масляной смазки с твердым наконечником и гибким шлангом
CZ Páková maznice s ravnou koncovkou
H Karos zsírzó
RO Masina de gresat cu furturn rigid
F Pistolet de graissage manuel
I Lubrificatore manuale
E Pistola de engrase
CN 手动黄油枪



COLOR BOX



P max.
70 MPa **P**
31 MPa **AI**

500
cm³

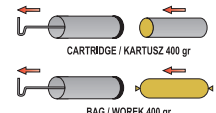

YATO
YT-0700



120
cm³

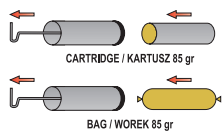

YATO
YT-0701



400
cm³

YATO
YT-0705

- GB** Grease gun
D Handhebel-Fettpresse
PL Smarownica ręczna
RUS Шприц для масляной смазки
CZ Páková maznice
H Karos zsírzó
RO Masina de gresat cu furturn rigid
F Pistolet de graissage manuel
I Lubrificatore manuale
E Pistola de engrase
CN 大容量黄油枪



COLOR BOX



P (MPa)
27-41 **AI**

600
cm³

YATO
YT-07042



800
cm³

YATO
YT-07043

- GB Two-way operation grease gun
- D Handhebel-Fettpresse
- PL Smarownica ręczna, wzmożniona
- RUS Шприц для масляной смазки
- CZ Páková maznice
- H Karos zsírzó
- RO Masina de gresat cu furturn rigid
- F Pistolet de graissage manuel
- I Lubrificatore manuale
- E Pistola de engrase
- CN 大容量黄油枪

COLOR BOX



500 cm ³	P max. 70 MPa	AI	P 42 MPa
------------------------	------------------	----	-------------

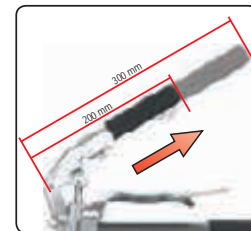
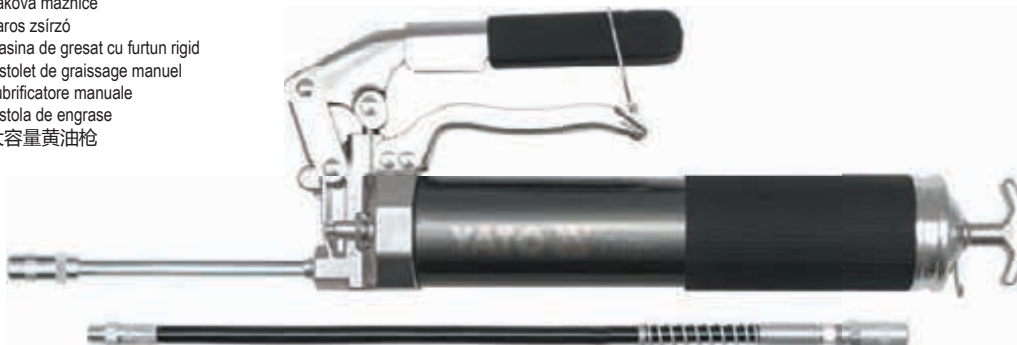

YATO	
YT-0704	12



HIGH PRESSURE 69 MPa	WYSOKIE CIŚNIENIE 69 MPa	LOW PRESSURE 6.9 MPa	NISKIE CIŚNIENIE 6.9 MPa
LOW VOLUME 14 g / 40 STROKE	NISKA WYDAJNOŚĆ 14 g / 40 CYKLI	HIGH VOLUME 100 g / 40 STROKE	WYSOKA WYDAJNOŚĆ 100 g / 40 CYKLI

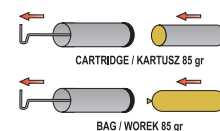

YATO	
YT-07041	10

- GB Air grease gun
- D Druckluft-Fettpresse
- PL Smarownica pneumatyczna
- RUS Шприц для нагнетания густой смазки пневматический
- CZ Mazací lis pneumatický
- H Pneumatikus zsírzó
- RO Pistol pt. gresat pneumatic
- F Pistolet de graissage pneumatique
- I Pneumatica per ingrassaggio
- E Pistola engrasadora neumática
- CN 气动黄油枪



400 cm ³	28 l/min	
---------------------	----------	--

IN: 0.2-0.8 MPa

OUT: 30-40 MPa

COLOR BOX



YATO	
YT-07055	10

L_{wa} = 93 ± 3 dB;
L_{wa} = 104 ± 3 dB;
a_v ≤ 2.5 m/s²

- | | | |
|-------------------------------|--|---------------------------------|
| GB Oil transfer pump | H Olajpumpa | E Bomba manual de trasvase dual |
| D Öl-Umfüllpumpe | RO Pompa de ulei de mana | CN 输油泵 |
| PL Pompa transferowa do oleju | F Pompe pour huile | |
| RUS Шприц для перекачки масел | I Lubrificatore manuale per travaso olio | |
| CZ Ruční olejová pumpa | | |

COLOR BOX



500 cm ³	P max. 70 MPa	P 31 MPa
------------------------	------------------	-------------



YATO	
YT-0707	20

- GB Oil drainer
- D Öl-Absaugpumpe
- PL Odsysarka ręczna do oleju
- RUS Ручной шприц для откачки масла
- CZ Ruční odsávačka oleje
- H Kézi olajszivattyú
- RO Pompa de ulei
- F Seringue à huile
- I Lubrificatore manuale per aspirazione olio
- E Bomba manual de trasvase
- CN 输油泵





COLOR BOX



500
cm³

P max.
70
MPa

P
31
MPa

YATO 	
YT-0708	20

- GB Grease pump
- D Manuelle fettpumpe
- PL Smarownica ręczna
- RUS Шприц для смазки
- CZ Maznice ruční
- H Kézi zsírzó pumpa
- RO Grăsimă manuală pompa
- F Pistolet de graissage manuel
- I Pompa manuali per grasso
- E Grasa manual de la bomba
- CN 黄油泵



GREY CARTON BOX
& COLOR LABEL

13.8
MPa
(max)

1.5m
HOSE
WAZ

- GB Pneumatic grease injector
- D Druckluft-Fettpresse
- PL Towotnica/smarownica pneumatyczna
- RUS Пневматический нагнетатель смазки
- CZ Pneumatiké-čerpadlo maziv
- H Pneumatikus zsír szivattyú
- RO Pompa de unsoare pneumatică
- F Pompe à graisse pneumatique
- I Pneumatica per ingrassaggio
- E Bomba de engrase neumática lubricar
- CN 注油器

12l

0.6-0.8
MPa

40
MPa
(max)

4m
HOSE
WAZ

50:1
RATIO
SPREZANIE







GREY
CARTON BOX
& COLOR
LABEL



L_{pa} = 97 ± 3 dB;
L_{wa} = 108 ± 3 dB

YATO 	
YT-07067	1

4kg

YATO 	capacity / wydajność (kg)	
YT-07061	4	1

8kg



YATO 	capacity / wydajność (kg)	
YT-07063	8	1

- GB Flexible tube for grease gun
- D Schlauch für Fettpresse
- PL Wężyk do towotnicy
- RUS Шприц для перекачки масел
- CZ Hadička na maznice na šmir
- H Tömlő a zsírzóhoz
- RO Furtun flexibil pt. pistol de gresat
- F Tuyau pour pistolet de graissage
- I Tubo flessibile per pompa grasso
- E Manguera para engrasador
- CN 手动黄油枪软管



SLIDING
CARD



YATO 	L (mm)	
YT-0709	300	12/144
YT-0710	500	12/144

- GB Oiler with a flexible applicator
- D Ölkanne mit elastischem Applikator
- PL Oliwiarka z elastycznym aplikatorem
- RUS Масленка с гибким аппликатором
- CZ Olejníčka s ohebným aplikátorem
- H Hajlékony csövű olajozó
- RO Gresor cu aplicator flexibil
- F Burette à huile
- I Lubrificante con canna flessibile
- E Aceitera con aplicador flexible
- CN 油壺



YATO	cm ³	
YT-0690	220	10/120
YT-0691	270	10/120

IMPACT RESISTANT
ODPORNE NA UDERZENIA

YATO	cm ³	
YT-06912	200	10/120

IMPACT RESISTANT
ODPORNE NA UDERZENIA



YATO	cm ³	
YT-06913	300	10/120

IMPACT RESISTANT
ODPORNE NA UDERZENIA



YATO	cm ³	
YT-06914	500	10/80

- GB Oil pump
- D Öl-Umfüllpumpe
- PL Pompa tłokowa do oleju
- RUS Шприц ручной заливной
- CZ Ruční olejová pumpa
- H Olajpumpa
- RO Pompa de ulei de mana
- F Pompe pour huile
- I Pompa manuale
- E Bomba manual para aceite
- CN 手摇泵

16-18 l/min	▽h 45-90 cm	55 min ⁻¹ (max)
0.3 l CYCLE	FOR OIL DO OLEJU	AI



COLOR BOX

YATO		
YT-0712		10

- GB Aluminium rotary oil pump
- D Aluminium-Kurbelpumpe
- PL Aluminiowa pompa do oleju
- RUS Алюминиевый ручной бочковой насос
- CZ Hliník rotační čerpadlo
- RO Aluminiu pompă rotativă
- F Pompe manuelle pour huile
- I Pompa a mano per olio
- E Aluminio bomba rotary
- CN 铝合金手摇油泵

21 l/min	▽h 500 cm	▽h 300 cm
3xPIPE 3xRURA	FOR OIL DO OLEJU	AI



COLOR BOX

YATO		
YT-07115		10

- GB High value rotary barrel pump
- D Kurbelpumpe für Benzinfässer
- PL Wysokowydajna pompa rotacyjna do paliwa
- RUS Насос топливный ротационный
- CZ Čerpadlo palivové rotační
- H Kézi pumpa hordóhoz (forgatható)
- RO Pompa rotativa pt. combustibil
- F Pompe rotative à combustible
- I Pompa rotativa travaso gasolio
- E Bomba de combustible rotatoria
- CN 手摇泵

FOR FUEL, DIESEL, OIL DO PALIW I OLEJU	1.0 l CYCLE CYKL	100 l/min
ANTISTATIC HOSE BEZANTYSTATYCZNY	2.4 m MOSIĘZNY FILTR	BRASS FILTER 180 µm MOSIĘZNY FILTR
	▽h 100 cm	AI



WHITE
CARTON BOX
& COLOR LABEL



YATO		
YT-0715		4

- GB** Two arms jaw puller
D Abzieher-2-armig
PL Ściągacz dwuramienny
RUS Съёмник для подшипников
CZ Stahovák
H Csapágylehűző
RO Extractor rulmenti

- F** Extracteur
I Estrattore
E Extractor
CN 两爪拉马

COLOR BOX



CrV

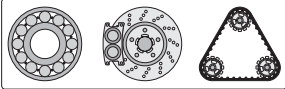

10 mm 4" 100mm

10 mm 3" 75mm

YATO	size / rozmiar	max. Ø (mm)	max. force / max. sila nacisku (t)	
YAT-2514	4" / 100 mm	60	1.2	6/60

YATO	size / rozmiar	max. Ø (mm)	max. force / max. sila nacisku (t)	
YAT-2515	3" / 75 mm	75	1.1	6/60



12 mm 4" 100mm

17 mm 6" 150mm



22 mm 8" 200mm

YATO	size / rozmiar	max. Ø (mm)	max. force / max. sila nacisku (t)	
YAT-2516	4" / 100 mm	100	1.4	12/48

YATO	size / rozmiar	max. Ø (mm)	max. force / max. sila nacisku (t)	
YAT-2517	6" / 150 mm	120	6	10/20

YATO	size / rozmiar	max. Ø (mm)	max. force / max. sila nacisku (t)	
YAT-2518	8" / 200 mm	180	9	6

- GB** Three arms jaw puller
D Abzieher-3-armig
PL Ściągacz trójramienny
RUS Съёмник для подшипников
CZ Stahovák třiramenný
H Csapágylehűző
RO Extractor rulmenti cu trei brate

- F** Extracteur
I Estrattore
E Extractor detres patas
CN 三爪拉马

COLOR BOX



CrV

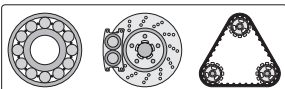

10 mm 3" 75mm

12 mm 4" 100mm

YATO	size / rozmiar	max. Ø (mm)	max. force / max. sila nacisku (t)	
YAT-2519	3" / 75 mm	80	1.5	6/60

YATO	size / rozmiar	max. Ø (mm)	max. force / max. sila nacisku (t)	
YAT-2520	4" / 100 mm	100	2.5	6/36



17 mm 6" 150mm

22 mm 8" 200mm



22 mm 12" 300mm

YATO	size / rozmiar	max. Ø (mm)	max. force / max. sila nacisku (t)	
YAT-2521	6" / 150 mm	130	5	12

YATO	size / rozmiar	max. Ø (mm)	max. force / max. sila nacisku (t)	
YAT-2522	8" / 200 mm	180	9	4

YATO	size / rozmiar	max. Ø (mm)	max. force / max. sila nacisku (t)	
YAT-2523	12" / 300 mm	180	11	2

- GB** Three arms jaw puller
D Abzieher-3-armig
PL Ściągacz trójramienny
RUS Съёмник для подшипников
CZ Stahovák třiramenný
H Csapágylehűző
RO Extractor rulmenti cu trei brate

COLOR BOX

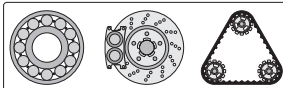

CrV

14 mm 3" 75mm

YATO	size / rozmiar	Ø (mm)	
YAT-2511	3" / 75 mm	50-150	20

15 mm 4" 100mm

YATO	size / rozmiar	Ø (mm)	
YAT-2512	4" / 100 mm	60-200	20

19 mm 6" 150mm

YATO	size / rozmiar	Ø (mm)	
YAT-2513	6" / 150 mm	80-300	10



- GB** Two leg puller for battery terminals and widescreen wiper arms
D Abzieher für Scheibenwischer / Wischerarm Spezial-Abzieher Polklemmen
PL Ściągacz dwuramienny do klem i ramion wycieraczek
RUS Съёмник стеклоочистителя терминал батареи дворники
CZ Stahovák na svorky akumulátorů a ramen stěračů
H Akkusaru és ablaktörölőkar-lehűző
RO Extractor brat stergator, cleme baterie
F Extracteur d'essuie glaces et cosse de batterie
I Estrattore 2 griffe
E Extractor tirador exterior para brazo del limpiaparabrisas / terminal de batería
CN 电瓶接头拉马

COLOR BOX



5-30 mm

ADJUSTABLE NASTAWNY



YATO	Ø (mm)	
YAT-25145	5-30	48

- GB** Universal puller set
- D** Abziehvorrichtung für Lager
- PL** Ściągacz do łożysk w miejscach trudnodostępnych
- RUS** Съёмник подшипников в труднодоступных местах
- CZ** Sada na stahování ložisek na obtížně dostupných místech
- H** Csapágyelhúzó
- RO** Trăgător pt. rulmenți în locuri greu accesibile
- F** Extracteur aux roulements
- I** Set di estrattori universali
- E** Extractor de rodamientos en lugares de difícil acceso
- CN** 多功能拉拔器

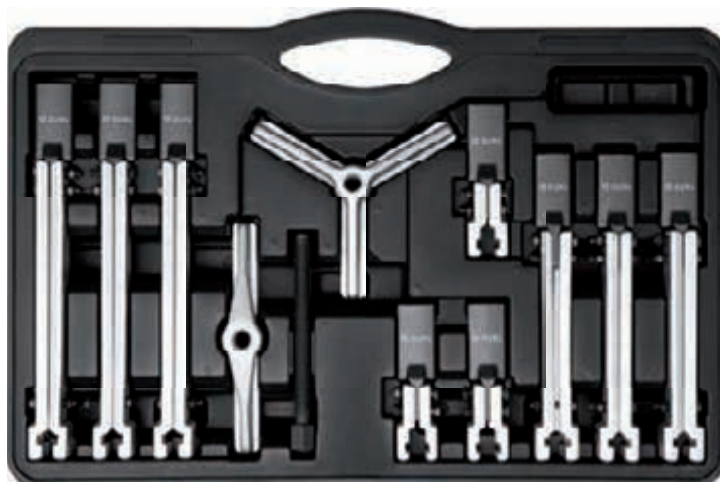
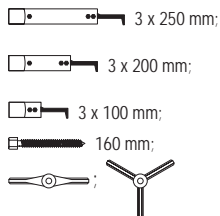

12
PCS

DROP
FORGED
KUTE

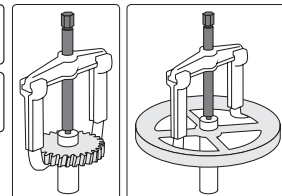

BMC
& COLOR
SLEEVE



YATO		
YT-25105		2

- GB** Pilot bearing puller
- D** Abzieher für Innenlager
- PL** Ściągacz do łożysk
- RUS** Съёмник внутренних подшипников
- CZ** Stahovák na ložiska vnitřní
- H** Csapágyelhúzó
- RO** Clește interior pt. extras rulmenți
- F** Extracteur intérieur aux roulements
- I** Estrattore cuscinetti
- E** Extractor de cojinetes inter.
- CN** 轴承拉马



13-38
mm

CrV
6150



YATO	Ø (mm)	
YT-2510	13-38	20

- GB** Universal wheel hub puller
- D** Scheiben- und Trommelbremsen Abzieher
- PL** Ściągacz uniwersalny do tarcz i bębnow
- RUS** Универсальный съёмник ступицы и полуоси
- CZ** Stahovák na brzdové bubny
- H** Univerzális féktárcsa és fékdob lehúzó

- RO** Trusa universală pt. transmisie cardană
- F** Extracteur universel pour les disques et les tambours
- I** Estrattore a vite universale
- E** Extractor universal de discos y tambores
- CN** 万用轮毂拉马

CrV

90-140
mm

130-180
mm

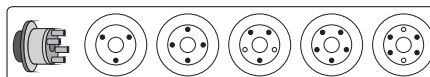

METAL CASE
& COLOR BOX

YATO	L (mm)	
YT-0602	200	6

- GB** Separator and hydraulic cylinder turnbuckle
- D** Separator und Abziehvorrichtung mit Hydraulikservomotor
- PL** Separator i ściągacz z silownikiem hydraulicznym
- RUS** Сепаратор и съёмник с сервомотором
- CZ** Oddělovač a stahovák s hydraulickým válcem
- H** Csapágyelhúzó és körmös csapágyelhúzó hidraulikus kézpumpával
- RO** Separator și ancoră cu servomotor hidraulic
- F** Séparateur avec actionneur hydraulique
- I** Separatore frizione cilindro idraulico
- E** Separador y tensor de tornillo con cilindro hidráulico
- CN** 液压分离器组合

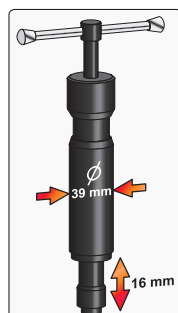

75-105 mm

2450 mm

50
kN

HRC
38-45

DROP
FORGED
KUTE

CrV



METAL CASE
& COLOR BOX

YATO	F (kN)	
YT-0609	50	2

- GB Twin leg puller with jaw hook
- D Doppel Abzieher mit Haken
- PL Ściągacz uniwersalny dwuramienny
- RUS Съёмник универсальный
- CZ Stahovák dvouarmenný univerzální
- H Csapágylehúzó készlet
- RO Carlig cu falci pt. extras cu picor dublu
- F Extracteur universel à deux bras
- I Estrattore universale a due bracci
- E Extractor de cuatro patas
- CN 单边两爪拉马



40-220 mm

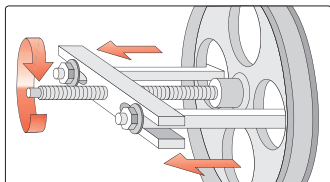
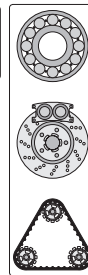

COLOR BOX

YATO	
YT-0640	10

- GB Gear puller set
- D Lagerabzieher, Trennmesser
- PL Ściągacz dwuramienny i separator
- RUS Съёмник универсальный с сепаратором
- CZ Stahovák dvouarmenný
- H Csapágylehúzó készlet
- RO Set angrenaj pt. extras
- F Extracteur 2 bras + separateur
- I Estrattore a due bracci a separatore
- E Kit de extractor
- CN 齿轮拉拔器



35-150 mm

max. 43 mm

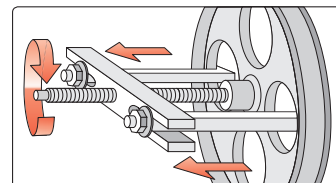
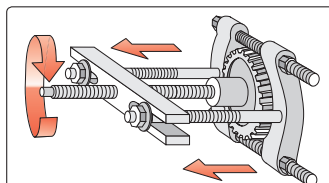
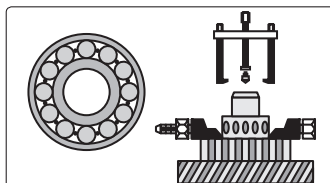
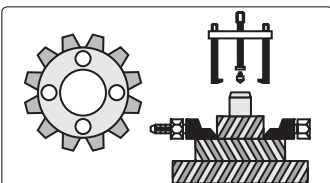
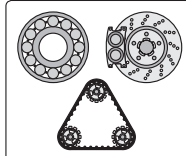

BMC & COLOR BOX

YATO	
YT-0641	4

- GB Slide hammer gear / bearing puller set
- D Träge Abziehvorrichtung für Lager
- PL Ściągacz bezwładnościowy do łożysk
- RUS Набор съёмников с обратным молотком
- CZ Rázový stahovák s kluzným kladivem na ložiska
- H Csúszósúlyos csapágylehúzó készlet
- RO Set ciocan culisant extractor de rulmenti
- F Extracteur de roulements à inertie
- I Set estrattori interni / esterni
- E Extractor de inercia para cojinetes
- CN 滑锤轴承拉拔器组套

5 PCS

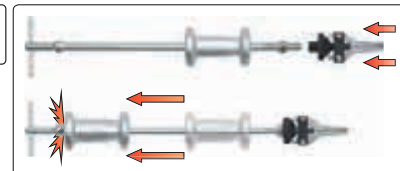

BMC & COLOR SLEEVE

YATO	
YT-2540	2

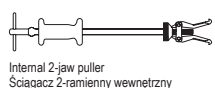
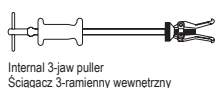
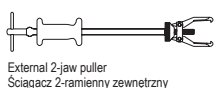
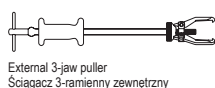

- GB** Slide hammer set
D Träge Abziehvorrichtung für Naben und Lager
PL Ściągacz bezwładnościowy do piast i łożysk
RUS Набор съемников с обратным молотком
CZ Rázový stahovák s kluzným kladivem na náboje a ložiska
H Csúszósúlyos kerékagy - és csapágyelhúzó készlet

- RO** Set ciocan culisant extractor de rulmenti și bușe
F Extracteur de roulements et moyeux à inertie
I Set estrattori per cuscinetti interno
E Extractor de inercia para cubos y cojinetes
CN 滑锤轴承拉拔器组套

13
PCS

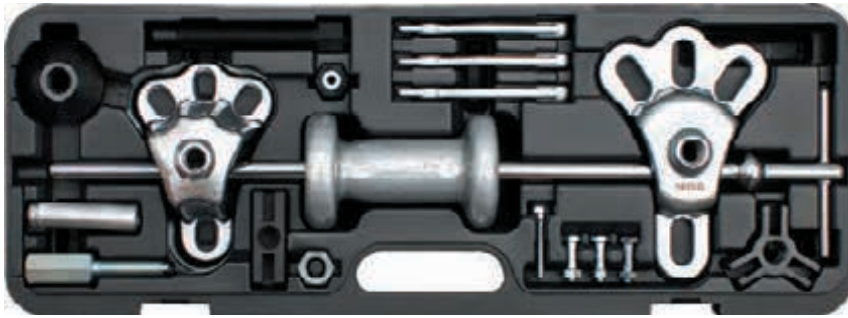
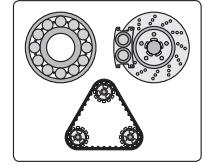
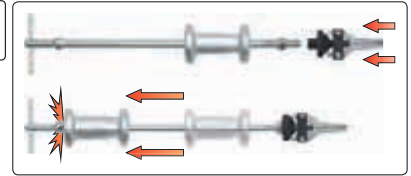

- | | | | | | | | | | | | |
|---|---|-----------------------------|---|---|---|--|---------------------------------------|-----------------------------|---------------------------|----------------|-------------|
| Bar
Trzonok | Hammer
Miot | Axle puller
Ściągacz osi | Grip wrench
adaptor
Przejsięciówka
do klucza | Nut
Kołnierz | 2-jaw head
Głowica
2-zaczeppowa | 3-jaw head
Głowica
3-zaczeppowa | Nut & bolt
Nakrętka
i śruba | Attachment
Gniazdo śruby | Leg
Ramie
ściągacza | Screw
Śruba | Hook
Hak |
| External 3-jaw puller
Ściągacz 3-ramienny zewnętrzny | External 2-jaw puller
Ściągacz 2-ramienny zewnętrzny | Puller hook
Hak | Dent puller
Ściągacz blacharski | Internal 3-jaw puller
Ściągacz 3-ramienny wewnętrzny | Internal 2-jaw puller
Ściągacz 2-ramienny wewnętrzny | Rear axle puller
Ściągacz tylny osi | Grip wrench adaptor
Adapter klucza | | | | |

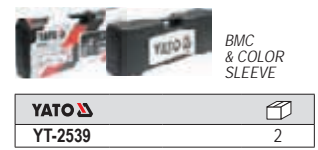

- GB** Slide hammer set
D Träge Abziehvorrichtung für Naben und Lager
PL Ściągacz bezwładnościowy do piast i łożysk
RUS Набор съемников с обратным молотком
CZ Rázový stahovák s kluzným kladivem na náboje a ložiska
H Csúszósúlyos kerékagy - és csapágyelhúzó készlet

- RO** Set ciocan culisant extractor de rulmenti și bușe
F Extracteur de roulements et moyeux à inertie
I Set estrattori per cuscinetti interno
E Extractor de inercia para cubos y cojinetes
CN 滑锤轴承拉拔器组套

16
PCS

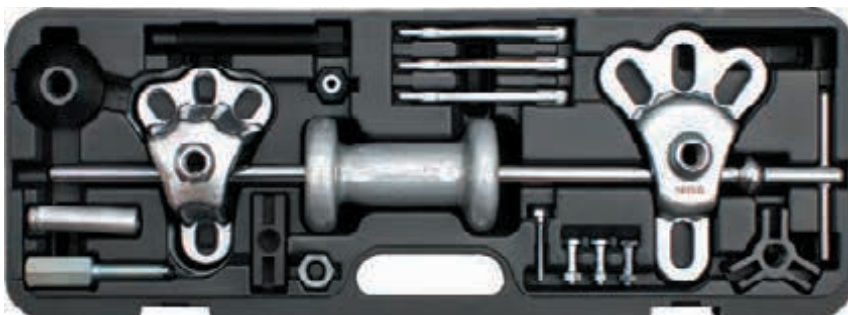
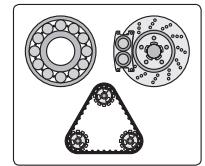
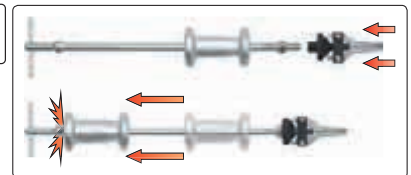

- | | | | | | | | | | | | |
|---|---|-----------------------------------|---|---|---|--|---|-----------------------------|---------------------------|----------------|-------------|
| Bar
Trzonok | Hammer
Miot | 2x Axle puller
2x Ściągacz osi | Grip wrench
adaptor
Przejsięciówka
do klucza | Nut
Kołnierz | 2-jaw head
Głowica
2-zaczeppowa | 3-jaw head
Głowica
3-zaczeppowa | 3x Nut & bolt
3x Nakrętka
i śruba | Attachment
Gniazdo śruby | Leg
Ramie
ściągacza | Screw
Śruba | Hook
Hak |
| External 3-jaw puller
Ściągacz 3-ramienny zewnętrzny | External 2-jaw puller
Ściągacz 2-ramienny zewnętrzny | Puller hook
Hak | Dent puller
Ściągacz blacharski | Internal 3-jaw puller
Ściągacz 3-ramienny wewnętrzny | Internal 2-jaw puller
Ściągacz 2-ramienny wewnętrzny | Rear axle puller
Ściągacz tylny osi | Grip wrench adaptor
Adapter klucza | | | | |



16

- GB** Front wheel bearing adapter set
D Radlagerabzieher werkzeugsatz vorderachse
PL Ściągacz łożysk piasty przedniej
RUS Набор для снятия переднего подшипника переднеприводных автомобилей
CZ Sada na demontáž ložisek přední nápravy
H Csapágyelhúzó adapter készlet első futóműhöz
RO Set schimbat rulment roata fata
F Extracteur de moyeux
I Set estrattori per cuscinetti ruota anteriore adattatore universale
E Extractor de cojinetes para cubos de rueda delanteros
CN 轴承拆装组套

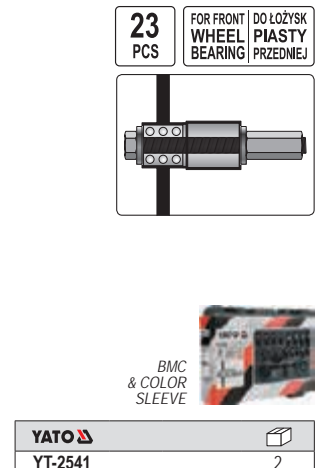
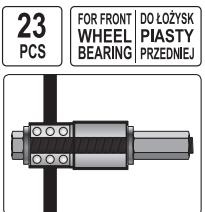

GB Small mouth pull clamp
D Selbstklemmende Blechschele
PL Klamra blacharska samozaciskowa
RUS Крепа самозажимная для жестяных работ
CZ Karosářská svěrka samosvorná k tahání

H Önszorító húzóató pofa, egyenes
RO Clemă pt. tablă cu strângere automată
F Boucle pour tôle auto-serrant

I Grappa
E Grapa de hojalatería autoprensora
CN 窄型张引夹

5t **125 mm** **42x20mm JAWS SZCZĘKI** **AUTO-TIGHTEN SAMC-ZACISKOWA**

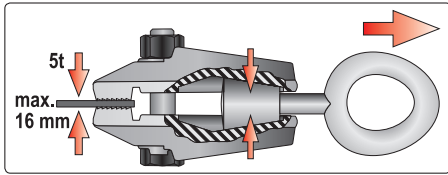

YATO	L (mm)	
YT-2542	125	12

GB Box clamp
D Selbstklemmende Blechschele vom Typ „C“
PL Klamra blacharska samozaciskowa typu „C“
RUS Крепа самозажимная для жестяных работ типа „C“
CZ Karosářská svěrka samosvorná k tahání typ „C“
H Önszorító húzóató pofa, öblös
RO Clemă pt. tablă cu strângere automată de tip „C“
F Boucle pour tôle auto-serrant

I Grappa tipo „C“
E Grapa de hojalatería autoprensora tipo „C“
CN 宽型张引夹

3t **142 mm** **35x15mm JAWS SZCZĘKI** **TYPE C** **AUTO-TIGHTEN SAMC-ZACISKOWA**

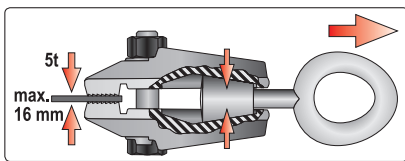

YATO	L (mm)	
YT-2543	142	10

GB Twist socket set
D Schraubendrehersatz
PL Zestaw wykrętków do śrub
RUS Инструмент для удаления сломанных винтов
CZ Sada vyťahováku stržených šroubů
H Törtcsavar kiszedő készlet

RO Set de chei pt. șuruburi
F Set d'extracteurs aux vis
I Set estrattori per dadi
E Juego de destornilladores
CN 螺栓取出器组套

10 PCS

3/8"
10mm

CrMo
HRC 52-55

GB Screw extractor set & HSS drill bits
D Schraubenausdrehersatz & HSS Bohrer
PL Wykrętki do zerwanych śrub i wiertła do metalu HSS
RUS Экстракторы и сверла по металлу HSS
CZ Vrtáky do přetržených šroubu & vrtáky na kov HSS
H Törtcsavar kiszedő készlet + fúrószárak fémhez HSS
RO Capete pt. deșurubat șuruburi rupte & burghie pt. metal HSS
F Set d'extracteurs aux vis
I Estrattori di vite HSS
E Destornillador para tornillos arrancados & HSS brocas
CN 断丝取出器组套

12 PCS **HSS**

M3-M24

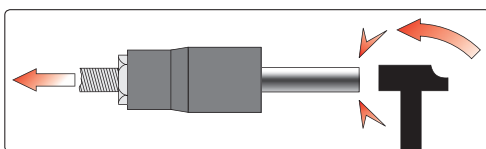

BMC & COLOR BOX



PLASTIC CASE & COLOR BOX



YATO	Ø (mm)	M	Ø [mm]	
YT-0591	1.4-3.6	3-6	1.8	40
	2.1-4.9	6-8	2.6	
	3.1-6.5	8-11	3.7	
	4.8-8.8	11-14	5.5	
	6.2-11.0	14-18	7.0	
	9.4-15.0	18-24	10.3	

YATO **YT-0603** **8/32**

GB Screw extractor set
D Schraubenausdrehersatz
PL Wykrętki do zerwanych śrub
RUS Набор для извлечения обломанных болтов
CZ Vrtáky do přetržených šroubu
H Törtcsavar kiszedő készlet
RO Capete pt. deșurubat șuruburi rupte
F Set d'extracteurs aux vis
I Estrattori di viti
E Destornillador para tornillos arrancados
CN 断丝取出器组套



PLASTIC BOX & SLIDING CARD



6 PCS

YATO	Ø (mm)	L (mm)	
YT-0590	3-6	52	12/48
	6-8	58	
	8-11	66	
	11-14	75	
	14-18	80	
	18-25	88	

GB Bolt extractor set
D Satz von Ausziehvorrichtungen für Stifte
PL Zestaw wykrętałów do szpilek
RUS Набор экстракторов для шпилек

CZ Souprava na demontáž závrtných šroubů
H Csavarkihajtó készlet
RO Set de șurubelnțe pt. tije
F Set d'extracteurs aux épingles

I Set bussole estrattore per brugola
E Juego de extractores de alfileres
CN 断丝取出器组套



STEEL 8660
HRC 49-52

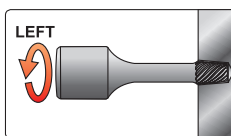

6
PCS
3/8"
10mm

5
PCS
1/2"
12.5mm



YATO	Ø (mm)	
YT-0623	2; 3; 4; 6; 8; 10	50

YATO	Ø (mm)	
YT-0624	8; 10; 12; 14; 16	20

GB Heavy duty nut splitter
D Meißelsatz für Schraubenmutter
PL Zestaw przecinaków do nakrętek
RUS Набор зубил для гаек
CZ Souprava sekáčů na matice
H Csavaranya-vágó
RO Set retezătoare capace
F Set de burins
I Set estrattore dado
E Juego de tajaderas para tuercas
CN 螺母破拆组套

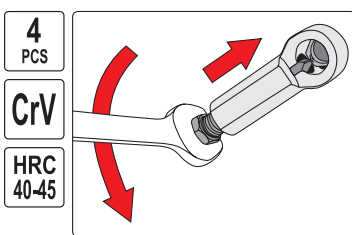

4
PCS
CrV
HRC 40-45

GB Roller stud extractor set
D Stehbolzenlösersatz
PL Komplet wykrętałów do szpilek
RUS Набор ключей для снятия штифтов
CZ Sada stahovadel na špendlíky
H Komplet tükihúzó
RO Set de dispozitive pt. demontat șuruburi rupte
F Set d'extracteurs de goupilles
I Estrattori a rulli per viti prigioniere
E Juego de extractores de agujas
CN 断丝取出器组套

4
PCS
CrV
50BV30

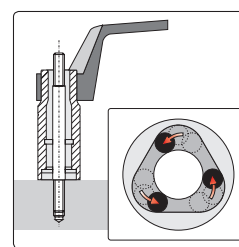

5/16" - 1/2" (9 - 12 mm);
 1/2" - 5/8" (12 - 16 mm);
 5/8" - 7/8" (16 - 22 mm);
 7/8" - 1-1/16" (22 - 27 mm)

YATO	
YT-0585	10

BMC & COLOR SLEEVE

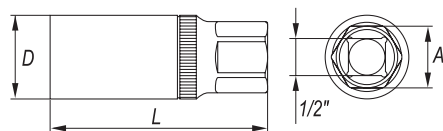

YATO	● (mm)	D (mm)	L (mm)	A (mm)	
YT-0620	6	24	60	21	6/24
	8				
	10	28	70		
	12				

GB Stud extractor
D Stehbolzenausdreher
PL Wykrętał do śrub szpilek i nakrętek
RUS Шпильковерт универсальный
CZ Klíč na povolení závrtných šroubů
H Sérülfejű csavar kiszedő
RO Extractor pt. suruburi
F Extracteur de goujon, écrou ou boulon arrondis
I Stud estrattore
E Extractor de esparragos
CN 断螺丝取出器



1/2"
12.5mm
8.5-19
mm

COLOR BOX

YATO	
YT-06251	10/30

GB Tie rod end lifter
D Universal-Kugelgelenk-Abzieher
PL Ściągacz do sworzni kulistych
RUS Съёмник шаровых опор
CZ Stahovák kulových čepů řízení
H Gömbfej kinyomó
RO Extractor pt. articulatii sferice

F Extracteur de rotue
I Estrattore per snodi sferici
E Extractor de pernos esféricos
CN 球头拉拔器

100
mm
20-60
mm



COLOR BOX



YATO	⌀ (mm)	L (mm)	Ø (mm)	
YT-06122	19	100	20	20

- GB** Tie rod end lifter
D Universal-Kugelgelenk-Abzieher
PL Ściągacz do sworzni kulistych
RUS Съёмник шаровых опор
CZ Stahovák kulových čepů řízení
H Gömbfej kinyomó
RO Extractor pt. articulatii sferice
- F** Extracteur de rotue
I Estrattore per snodi sferici
E Extractor de pernos esféricos
CN 球头拉拔器

135
mm



COLOR BOX



YATO 	 (mm)	L (mm)	Ø (mm)	
YT-0612	19	135	17.5	9/18

- GB** Rod end remover
D Lenkstangeabzieher
PL Ściągacz do drążków kierowniczych
RUS Съёмник рулевых тяг
CZ Přípravek na demontáž kulových čepů řízení
H Gömbfej kiütő
- RO** Tija pt. indepartat
F Extracteur pour rotules de direction
I Estrattori perni e tiranti sterzo
E Extractor de barras de acoplamiento
CN 拉拔器

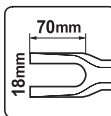
200
mm



COLOR BOX

YATO 	L (mm)	
YT-0615	200	18/36

- GB** Track rod end remover & installer set
D Schlüsselersatz für Zahnstangenlenkung
PL Zestaw kluczy do drążków kierowniczych
RUS Набор ключей для рулевых тяг
CZ Sada klíčů pro hřeben řízení
H Kormányrúd telepítő készlet-eltávolító
- RO** Set montare-demontare bieleta
F Clé pour rotules de direction
I Set di chiavi suggerimenti smontaggio tiranti sterzo
E Herramienta de llaves para barras de dirección
CN 件套轴接头工具组

4
PCS

Ø mm
30-45



Ø 30-35mm, 35-40mm, 40-45mm

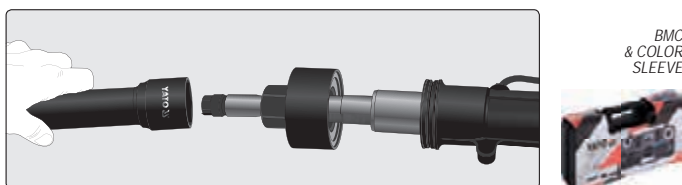

BMC & COLOR SLEEVE

YATO 	
YT-06155	2



- GB** Tie rod end lifter
D Universal-Kugelgelenk-Abzieher
PL Ściągacz do sworzni kulistych
RUS Съёмник шаровых опор
CZ Stahovák kulových čepů řízení
H Gömbfej kinyomó
- RO** Extractor pt. articulatii sferice
F Extracteur de rotue
I Estrattore per snodi sferici
E Extractor de pernos esféricos
CN 球头拉拔器

265
mm

275
mm



COLOR BOX

YATO 	 (mm)	L (mm)	Ø (mm)	
YT-0613	16	265	17	20
YT-0614	16	275	20	20

- GB** Inner tie rod tool
D Spurstangengelenk Lösewerkzeug
PL Klucz do drążków kierowniczych
RUS Ключ для шарнира рулевой рейки
CZ Přípravek na axiální táhla
H Csukló szerelő
RO Cheia de la tija de cravată
F Clé pour pour rotules de direction
I Chiave per il tirante
E Extractor mecanismo de dirección
CN 大机松扳手

Ø mm
35-42



COLOR BOX

YATO 	
YT-06160	25

- GB** Tie rod / ball joint tool kit
D Werkzeugsatz für Bremssattel
PL Ściągacze do drążków
RUS Съёмник штанг
CZ Stahováký táhel řízení
H Rüdlehúzó
- RO** Ancore pt. tije
F Set d'extracteurs pour rotules de direction
I Set tiranti per estrattore
E Tensores para palancas
CN 球头拉拔器组套

6
PCS

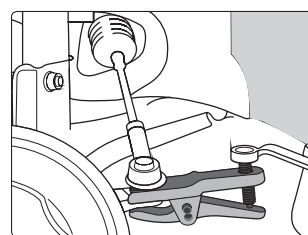

BMC & COLOR SLEEVE

YATO 	
YT-06157	4

- GB Tie rod / ball joint tool kit
- D Werkzeugsatz für Bremssattel
- PL Ściągacze do drążków
- RUS Съёмник штанг
- CZ Stahováky táhel řízení
- H Rúdlehúzó
- RO Ancore pt. tije
- F Set de leviers à tête réglable
- I Set di estrattori perni e tiranti sterzo
- E Tensores para palancas
- CN 球头拉拔器组套

for / dla: YT-0990

5
PCS

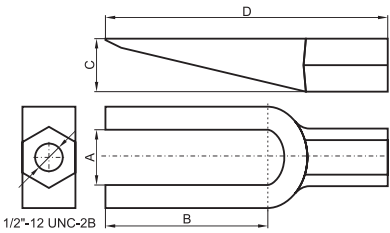
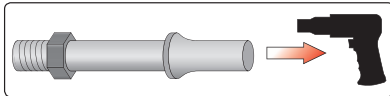
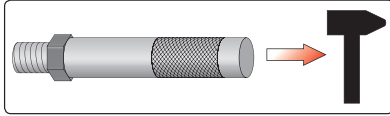

BMC & COLOR BOX



YATO		A (mm)	B (mm)	C (mm)	D (mm)	
YT-0616	I	18.2	65.0	24.0	123.9	10
	II	25.2	67.8			
	III	30.2	56.3			

- GB Seal puller
- D Dichtungs-Abziehwerkzeug
- PL Ściągacz do uszczelek
- RUS Съёмник прокладок
- CZ Škrabka na těsnění
- H Tömítéslehúzó
- RO Ancoră pt. garnituri
- F Outil pour extraire les joints
- I Estrattore per guarnizioni
- E Tensor para juntas
- CN 密封圈拉拔器

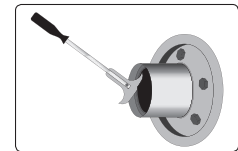

max. ∅
85mm

SLIDING CARD

YATO	L (mm)	
YT-0642	200	12/48

- GB Bearing race and seal driver set
- D Presssatz für sicherungsringe, lager, etc.
- PL Zestaw do osadzania łożysk i uszczelnaczy
- RUS Втулка и набор сальниковых уплотнителей для автомобиля
- CZ Sada na montáž gufer
- H Csapágy, szimering, persely ki- és beütő készlet
- RO Set pt. inlocuit rulment, simering
- F Set de simerings
- I Set di tamponi per cuscinetti e guarnizioni
- E Jugeo de conductores del anillo y del sello de rodadura
- CN 斜型培令套安装器



10
PCS

AI

BMC & COLOR SLEEVE

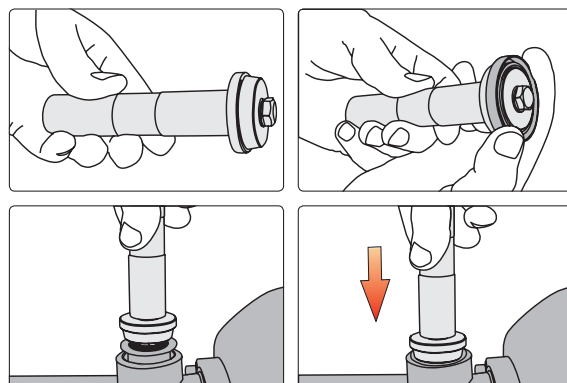

YATO	No.	∅ (mm)	
YT-0638	01	40	5/10
	02	44	
	03	50	
	04	59	
	05	63	
	06	65	
	07	72	
	08	76	
	09	81	

- GB** Car radio removal tool set
D Autoradio Demontage Werkzeugsatz
PL Zestaw do demontażu radioodbiorników samochodowych
RUS Набор для разборки авто-ресиверов
CZ Sada k demontáži autorádií
H Autórádió kiszerező készlet
RO Trusa de scule pt. indepartat radio
F Set d'outils pour dépose autoradio
I Set estrattori per autoradio
E Juego para el desmontaje de autorradio
CN 收音机拆卸组套

- 2 radio removal U-hook (Ford, VW, Audi, Grundig, Blaupunkt)
- 1 special pentagon wrench (BMW)
- 4 radio removal keys (VW, Audi, Becker, Mercedes)
- 2 radio removal keys (Mercedes, Porsche, Becker)
- 2 radio removal keys (VW)
- 1 allen hex wrench (BMW, Opel)
- 2 radio removal keys (new Becker)
- 2 radio removal keys (new Skoda)
- 2 radio removal keys U-hook (new Blaupunkt)
- 2 radio removal keys (Fiat Brava)
- 2 radio removal U-hook (Opel Doppel-Kugel-Inbus)
- 6 radio removal keys (Mercedes-Benz, BMW)
- 2 radio removal keys (Kenwood II 1998-2001)
- 2 radio removal keys (Sony II since 2002)
- 2 radio removal keys (Kenwood III since 2002)
- 2 radio removal keys (Pioneer, JVC)
- 2 radio removal keys (Sony I until 2001)
- 2 radio removal keys (Panasonic)
- 2 radio removal keys (Kenwood I until 1998)
- 2 radio removal keys (Kenwood mask)
- 2 radio removal keys (new Clarion)
- 2 radio removal keys (old Clarion)
- 2 radio removal keys (Panasonic 2006)
- 2 radio removal keys (Sony IDIC 2005)



52
PCS

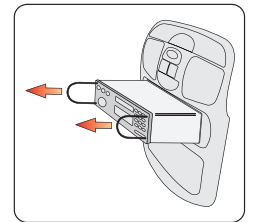
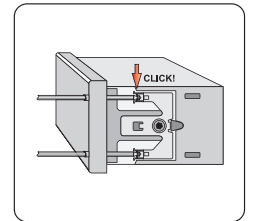
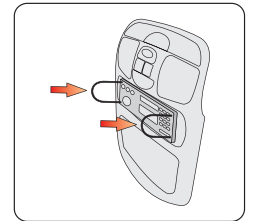

BMC
& COLOR
SLEEVE



YATO 	
YT-0838	10

- GB** Emergency automotive lock-out tool set
D Werkzeugsatz zum Öffnen der Autotür im Notfall
PL Zestaw do awaryjnego otwierania drzwi samochodowych
RUS Набор для аварийного відкриття автомобільних дверей
CZ Souprava k nouzovému otevírání dveří automobilů
H Személygépkocsi ajtó vésznyitó készlet
RO Set pt. deschiderea de avarie a ușilor de mașină
F Set ouverture de porte fermée
I Set estrattori per apertura automotore
E Juego de herramientas para abrir las puertas de coche en casos de urgencia
CN 车门锁拆卸工具



9
PCS

STAINLESS
STEEL
STAL
NIEŹYŻNA

PVC

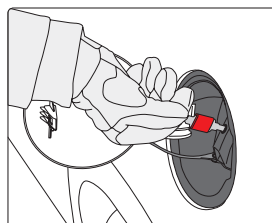
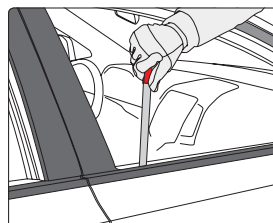
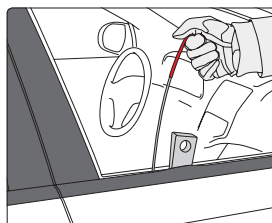
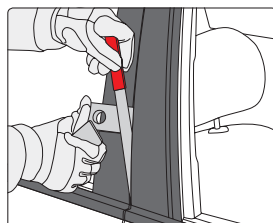

POUCH

YATO 	
YT-08385	25

GB Door upholstery remover
D Abziehvorrichtung für Polstererklammern
PL Ściągacz do spinek tapicerki
RUS Съемник крепежа обивки

CZ Uvolňovač čalounění dveří
H Kárpitkiszedő
RO Dispozitiv de scos agrafe de tapițerie

F Arrache agrafes
I Estrattore per la rimozione di graffette tappezzeria

E Extractor de grapas de vestidura
CN 胶扣起子

SVCM



YATO	size / rozmiar (mm)	
YT-1370	6x100	12/120

YATO	size / rozmiar (mm)	
YT-1371	6.2x115	12/120



YATO	size / rozmiar (mm)	
YT-1372	10x115	12/120

YATO	size / rozmiar (mm)	
YT-1373	9.5x134	6/96

GB Scratch awl
D Einfache Spicknadel
PL Szpikulec prosty
RUS Прямое острие

CZ Šídlo rovné
H Spékelőtű, egyenes
RO Dorn perforare drept
F Brochette droite
I Punteruolo piatto
E Ponzón recto
CN 锥子

SVCM

GB Hook bodkin
D Hakenspicknadel
PL Szpikulec hakowy
RUS Крюковое острие
CZ Šídlo háčkové
H Spékelőtű, horgos
RO Dorn perforare indoit
F Brochette coudée
I Gancio punteruolo
E Ponzón encorvado
CN 油封拉拔器

SVCM 90°



YATO	L (mm)	
YT-1374	120	12/120

YATO	L (mm)	
YT-1375	125	12/120

GB Battery cap tool
D Abziehvorrichtung für Akkuklemmen
PL Ściągacz do klemm akumulatora
RUS Стяжка для клемм аккумулятора
CZ Stahovák svorek akumulátoru
H Akkumulátor saru lehzó

RO Extractor pt. cleme acumulator
F Tournevis plat pour bouchons de batterie
I Batteria clem estrattore
E Extractor para los bornes de la batería
CN 扁铲

SVCM

GB Glass scraper
D Scheibenkratzer
PL Skrobak do szyb
RUS Шабер для стекла
CZ Škrabka na okna
H Jégkaparó
RO Răzuitor geamuri
F Gratteur pour vitres
I Raschietto per vetro
E Rascador para los vidrios
CN 刮刀

SVCM



YATO	size / rozmiar (mm)	
YT-1378	18.5x100	12/120

YATO	size / rozmiar (mm)	
YT-1379	39x200	6/72

GB Spare blades for glass scraper
D Abbrechklängen
PL Ostrze do skrobaka do szyb
RUS Лезвия для универсальных ножей
CZ Lomené ostří náhradní
H Törhető tartalékpenge
RO Lame de rezervă rupte

F Lames pour gratteur pour vitres
I Lame per raschietto
E Filo partido de recambio
CN 刮刀刀片

10 PCS SK5

for / dla: YT-1379



COLOR BOX

YATO	size (mm)	
YT-13790	19x39	50

GB Flexible spinner handle
D Elastischer Dreher
PL Pokrętko elastyczne
RUS Эластичный вороток
CZ Šroubovák ohebný
H Hajlékony csavarhúzó
RO Mâner flexibil
F Barre élastique
I Chiave flessibile
E Llave flexible
CN 套筒螺丝批

1/4" 6.3mm SVCM



YATO	size / rozmiar	
YT-1381	1/4" (6.3 mm) x 150 mm	6/96

GB Flexible magnetic bit driver
D Elastischer Dreher für Bits
PL Pokrętko elastyczne do bitów

RUS Эластичный вороток для разряда битов
CZ Šroubovák ohebný na bity
H Hajlékony csavarhúzó, hosszú

RO Mâner flexibil pt. vârf șurubelniță
F Barre élastique
I Chiave flessibile

E Mango flexible para desarmadores
CN 批头螺丝批

SVCM



YATO	size / rozmiar	
YT-1382	1/4" (6.3 mm) x 380 mm	6/72

GB Flexible magnetic pick up tool
D Elastische Magnethalterung
PL Elastyczny uchwyt magnetyczny

RUS Эластичный магнитный держатель
CZ Ohebný magnetický držák
H Hajlékony csavarhúzó,

hosszú, mágneses
RO Mâner magnetic flexibil
F Capteur magnétique

I Chiave flessibile
E Mango magnético flexible
CN 捡拾器

SVCM



YATO	L (mm)	
YT-1385	400	6/72

GB Door upholstery remover
D Abziehvorrichtung für Polstererklammern
PL Ściągacz do spinek tapicerki
RUS Съемник крепежа обивки

CZ Uvolňovač čalounění dveří
H Kárpitkiszedő
RO Dispozitiv de scos agrafe de tapițerie
F Spatule d'extraction de clips

I Estrattore per la rimozione di graffette tappezzeria
E Extractor de grapas de vestidura
CN 胶扣起子

SLIDING CARD



230 mm	YATO	L (mm)	
	YT-0841	230	16/64

200 mm	YATO	L (mm)	
	YT-0842	200	25/100

- GB** Panel removal set
D Abziehvorrichtung für Polsterung
PL Ściągacze do tapicerki
RUS Съёмник обивки
CZ Sada k demontáži čalounění
H Kárpitlehúzó
RO Ancore pt. tapițerie
F Set d'extracteurs à la tapisserie
I Leve in plastica per la tappezzeria
E Tensores para las vestiduras
CN 面板拆卸组套

DOUBLE
BLISTER



IMPACT
RESISTANT
NYLON
ODPORNE
NA UDARZENIA

NO SCRATCH
BEZ
ZADRAPAN

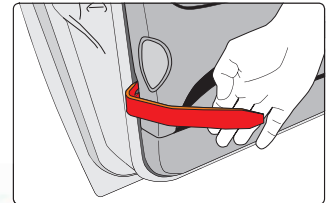

5
PCS

6
PCS



YATO
YT-0836 6/24

YATO
YT-0837 6/24

- GB** Panel removal set
D Abziehvorrichtung für Polsterung
PL Ściągacze do tapicerki
RUS Съёмник обивки
CZ Sada k demontáži čalounění
H Kárpitlehúzó
RO Ancore pt. tapițerie
F Set d'extracteurs à la tapisserie
I Leve in plastica per la tappezzeria
E Tensores para las vestiduras
CN 面板拆卸组套

POUCH
& COLOR
BOX



11
PCS



YATO
YT-0844 5/10

- GB** Set of plastic scrapers
D Satz von Kunststoffschabern
PL Zestaw skrobaków plastikowych
RUS Набор пластмассовых шпателей
CZ Souprava plastových škrabek
H Műanyag vakaró készlet
RO Set de răzuitoare din plastic
F Kit de grattoirs en plastique
I Set di raschietto
E Juego de rascadores de plástico
CN 塑料刮刀

4
PCS

265
mm

IMPACT
RESISTANT
NYLON
ODPORNE
NA UDARZENIA

NO SCRATCH
BEZ
ZADRAPAN



3/4" (19 mm) 7/8" (22 mm) 1" (25 mm) 1.1/2" (37.5 mm)

SLIDING
CARD



YATO
YT-0847 L (mm) 265 6/36

- GB** Quick release cut out tool
D Schneidmesser für Scheiben
PL Nóż do wycinania szyb
RUS Нож для вырезания стекол
CZ Nůž na vyřezávání skel
H Szélvédőkivágó kés
RO Cuțit tăietor de geam
F Kit de découpe pare-brise
I Tagliolo per il verto
E Cuchilla para cortar cristales
CN 玻璃橡胶刮除器



3x
BLADES
OSTRZA

Alu
HANDLE
UCHWYT

QUICK
RELEASE
SZYBKO-
ZŁĄCZE

K5

SLIDING
CARD



YATO
YT-0659 20/40

- GB** Spare blades for cut out tool
D Abbrechklengenn
PL Ostrza zapasowe do noża do wycinania szyb
RUS Лезвия для ножей
CZ Ostří náhradní
H Törhető tartalékpenge
RO Rezerve cutter
F Lames
I Lame di ricambio per coltello specialistica per tagliare vetri del auto
E Filo partido de recambio
CN 玻璃橡胶刮除器刀片



3x
BLADES
OSTRZA

K5

for / dla: YT-0659

SLIDING
CARD



3/4" (19 mm);
1" (25 mm);
1-1/2" (38 mm)

YATO
YT-06590 10/80

- GB** Windshield removal set
D Demontagesatz für Autoscheiben
PL Zestaw do demontażu szyb samochodowych
RUS Набор для демонтажа автостекла
CZ Souprava na demontáž autoskel
H Szélvédőcserélő szett

- RO** Set pt. demontarea geamurilor de maşină
F Kit pour démontage de vitres de voiture
I Set di strumenti di rimozione parabrezza
E Juego para desmontaje de cristales de coches
CN 风挡玻璃拆卸组套

7
PCS

HRC
38-42



COLOR BOX



YATO
YT-0845 10

- GB** Windscreen wiper arm removal tool
D Abziehvorrichtung für die Scheibenwischerarme
PL Ściągacz do ramion wycieraczek
RUS Съёмник поводков стеклоочистителя
CZ Stahovák na ramínka stěračů
H Ablaktörökár lehűző
RO Siguranță pt. brațele ștergătoarelor
F Bord aux bras d'essuie-glace
I Estrattore di parabrezza tergicristallo braccio
E Herramienta para desmontaje de las plumas de los limpiaparabrisas
CN 雨刷臂拆卸工具

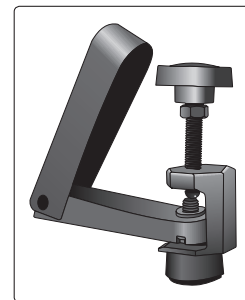

SLIDING CARD



YATO
YT-0846 12/120

- GB** Two leg puller for battery terminals and wiperscreen wiper arms
D Abzieher für Scheibenwischer / Wischerarm Spezial-Abzieher Polklemmen
PL Ściągacz dwuramienny do klem i ramion wycieraczek
RUS Съёмник стеклоочистителя терминал батареи дворники
CZ Stahovák na svorky akumulátorů a ramen stěračů
H Akkusaru és ablaktörökár-lehűző
RO Extractor brat ștergator, cleme baterie
F Extracteur d'essuie glaces et cosse de batterie
I Estrattore 2 griffe
E Extractor tirador exterior para brazo del limpiaparabrisas / terminal de batería
CN 电瓶接头拉马



5-30
mm

ADJUSTABLE
NASTAWNY

COLOR BOX

YATO
YT-25145 5-30 48

- GB** Spring clamp remover V.A.G.
D Auspuff Federklammer entferner / installer für V.A.G.
PL Ściągacz do obejm i sprężyn V.A.G.
RUS Съёмник пружинных, хомутов систем выпуска V.A.G.
CZ Přípravek na montáž a demontáž svorky výfuku V.A.G.
H Kipufogó rugó szerelő V.A.G.
RO Dispozitiv montat / demontat esapament V.A.G.
F Tuyau d'échappement printemps pince outil de suppression pour V.A.G.
I Spring clamp rimozione
E Abrazadera de resorte herramienta de eliminación-para V.A.G.
CN 弹簧撑



17
mm

FOR / DLA
V.A.G.

SLIDING CARD



YATO
YT-25331 12/24

- GB** Puller for ribbed drive pulley
D Riemenscheiben Abzieher Werkzeug Keilriemenscheiben
PL Ściągacz kół pasowych wielorokowych
RUS Универсальный съёмник шкива
CZ Staviteľný stahovák drážkových řemenic
H Bordás szíjtárcsa lehűző
RO Tragator de scripete reglabil
F Universel extracteur de poulie d'entraînement cannelé
I Estrattore puleggia motrice a coste
E Extractor de polea acanalada
CN 皮带轮拉马

40-165
mm

17
mm

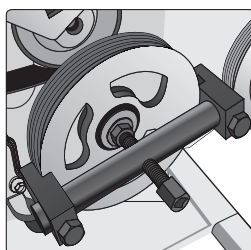

COLOR BOX

YATO
YT-25480 10

- GB** Fuel tank sender unit spanner
D Tankgeberschlüssel
PL Klucz pazurkowy do pompy paliwa
RUS Ключ для крышки топливного насоса
CZ Nastavitelný klíč na šrouby palivových nádrží
H Üzemanyag jeladó kisedő
RO Cheie reglabila pt. pompa combustibil pe rezervor
F Outil de démontage de pompe
I Chiave smontaggio galleggiante serbatoio
E Llave de tres garras para aforador
CN 油箱盖拆装工具

24
mm

75-160
mm

3 REGULATED
ARMS
3 REGULOWANE
RAMIONA



COLOR BOX



YATO
YT-06288 40

- GB** CV boot clamp pliers
D Zange für Schellen der Gelenkabdeckung
PL Szczypce do oprasek osłony przegubu
RUS Щипцы для хомутов крепления кожуха шарнира
CZ Kleště na spony manžety kloubu
H Féltengely bilincs húzó fogó
RO Clește pt. brățară de husă la articulație
F Pince pour collier à recouvrement de joint
I Pinza a morsetto per fascette pinzabili
E Alicates para abrazadera de protección de la junta
CN 夹紧钳

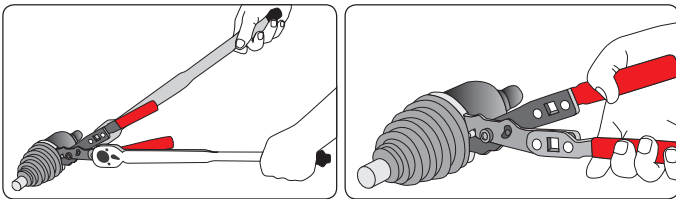

YATO	L (mm)	
YT-0606	235	6/36

- GB** Lock-ring pliers
D Spreizzange für Schellen
PL Szczypce rozporowe do pierścieni osadczycy
RUS Щипцы распорные для стяжных хомутов
CZ Kleště na hadicové spony
H Seeger fogó
RO Clește pt. desfacerea brățarelor de strângere
F Pince tenaille pour les bagues de retenue
I Pinza per rondelle elastiche scanalata
E Alicates para abrazaderas
CN C 型扣钳



YATO	L (mm)	
YT-0607	225	12/72

- GB** Transmission line disconnect tool set
D Werkzeugsatz zum Trennen von Kraftstoffleitungen
PL Zestaw do rozłączania przewodów
RUS Набор для рассоединения топливopроводов
CZ Sada na rozpojování palivového potrubí
H Üzemanyagszó-lebontó készlet
RO Set pt. deconectarea liniilor de combustibil
F Set pour disjoindre des câbles
I Set per scollegare i tubi di carburante
E Juego para desconectar conductos de combustible
CN 油管拆卸组套



- GB** Fuel feel pipe pliers
D Zange für Tankverschlüsse
PL Szczypce do złączek paliwowych
RUS Щипцы для топливных соединений
CZ Kleště na spojky palivového systému
H Üzemanyagvezeték fogó
RO Clește pt. conectoare de combustibil
F Pince tenaille pour connecteurs de carburant
I Pinza per tubo carburante
E Alicates para enchufes de combustible
CN 油管钳

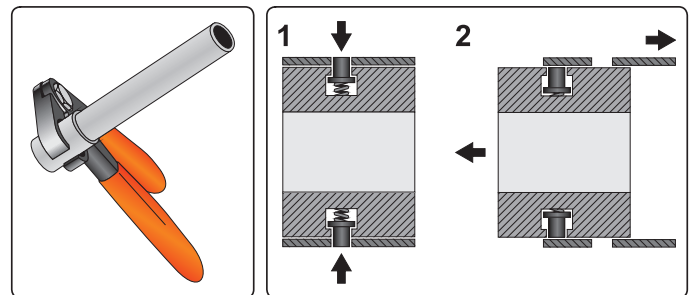

YATO	
YT-0608	10/40

- GB** Hose removing pliers
D Schlauch- und Kabellösezange
PL Szczypce do zdejmowania przewodów
RUS Клещи для снятия изляции
CZ Kleště na demontáž hadic
H Tömlőbilincs fogó
RO Clește pt. indepartat furtune
F Pince pour enlever les fils
I Pinza spelacavi universale
E Alicates de extracción de mangueras
CN 油管分离钳

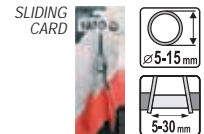

YATO	
YT-0657	6/36

YATO	
YT-0630	20

BMC & COLOR SLEEVE



- GB** Spark plug puller set VAG
- D** Abzieher-Satz Zündspulen VAG
- PL** Zestaw ściągaczy do cewek zapłonowych VAG
- RUS** Набор съёмников для катушек зажигания VAG
- CZ** Sada stahováků zapalovací cívk
- H** Gyújtótekercs lehűző készlet
- RO** Set bobina de aprindere tractor
- F** Set d'extracteurs des bobines d'allumage
- I** Set per la rimozione rapida bobine di accensione nelle auto VAG
- E** Extractores bobinas de encendido grupo VAG
- CN** 四件套火花塞维修工具



BMC & COLOR SLEEVE

4 PCS

FOR / DLA VAG.

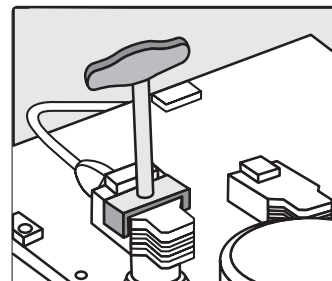

for / dla: VW, Audi, Skoda, Seat

YATO			
YT-06205	T type 1		Volkswagen FSI Golf / Bora 1998, Polo 2002, Touran 2004, New Beetle 2003, Passat 1997, T4+Audi A2 2001
	T type 2		Silniki/engines 6 cyl. 24V, 5 cyl, Golf / Bora 1998, Passat / Touareg 1997, Sharan 1996, Phaeton / Toureg 6 cyl. 2003, T5 z 6 cyl. silnikami 2004
	T type 3		Volkswagen silnik / engines 2.0 z bezp. wtrysk / direct injection, Touran 2004, Passat 2006, Audi z bezp.wtrysk / direct injection A3 2.0 2004, A6 3.2 2005
	T type 4		Volkswagen z bezp. wtrysk / direct injection 2.0, Golf / Touran 2004, Passat 2006, Audi z bezp. wtrysk / direct injection, A3 2.0 2004, A6 3.2 2005

- GB** Spark plug terminal pliers
- D** Zange für das Zündkerzenkabel
- PL** Szczypce do przewodów świec zapłonowych
- RUS** Щипцы к проводам свечей зажигания
- CZ** Kleště na kabely zapalovacích svíček
- H** Gyújtógyertya-kábel fogó
- RO** Clește pt. conductele bujiilor de aprindere
- F** Pince pour fils d'allumage
- I** Pinze per candele
- E** Pinzas para los cables de las bujias de ignición
- CN** 火花塞高压线钳

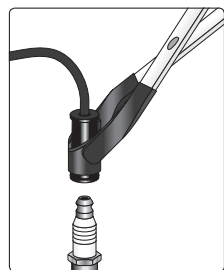

SLIDING CARD

200 mm

255 mm

YATO	L (mm)	
YT-7320	255	10/60

- GB** Multi-purpose hose & wire pliers
- D** Zangensatz für Schellen und Leitungen
- PL** Komplet szczypiec do opasek i przewodów
- RUS** Набор щипцов к хомутам и проводам
- CZ** Souprava kleští na spony a hadice
- H** Fogókészlet bilincsekhez és vezetékhez
- RO** Set clește pt. benzi și conducte
- F** Pince pour collier de serrage
- I** Set pinze per il morsetto
- E** Juego de pinzas para abrazaderas y cables
- CN** 多功能管夹钳

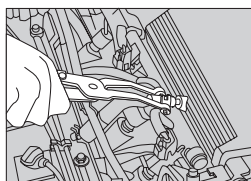

For engine air pipe
Do przewodów powietrznych listwy wtryskowej

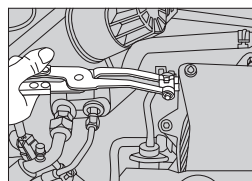

For engine intake air pipe
Do przewodów gumowych układu zasilania

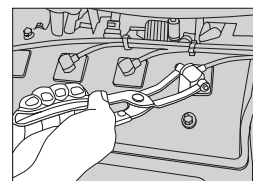

For spark plug lead
Do przewodów zapłonowych

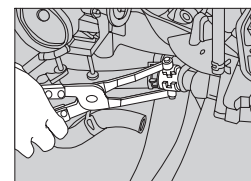

For cooling water pipe
Do przewodów gumowych układu chłodzenia



2 PCS

1/4"-3/4"

6.3-19.0 mm

217 mm

254 mm

SLIDING CARD

YATO	L (mm)	
YT-0645	217	6/24
	254	

GB Hose clamp pliers
D Zange zum Entspannen der Klemmschellen
PL Szczypce do opasek zaciskowych rozprężnych
RUS Щипцы к хомутам зажимным распорным
CZ Kleště na samosvorné hadicové spony
H Vízcsőbilincs fogó

RO Clește pt. benzile de strângere destindere
F Pince pour collier de serrage
I Set pinze per il morsetto
E Pinzas para las abrazaderas de expansión
CN 管夹钳

SLIDING
CARD

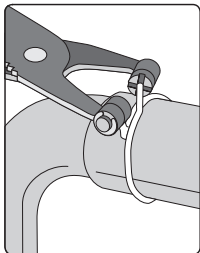

YATO	L (mm)	
YT-0646	215	12/72

GB Hose clamp pliers
D Zange zum Entspannen der Klemmschellen
PL Szczypce do opasek zaciskowych rozprężnych
RUS Щипцы к хомутам зажимным распорным
CZ Kleště na samosvorné hadicové spony
H Vízcsőbilincs fogó

RO Clește pt. benzile de strângere destindere
F Pince pour collier de serrage
I Set pinze per il morsetto
E Pinzas para las abrazaderas de expansión
CN 管夹钳

SLIDING
CARD

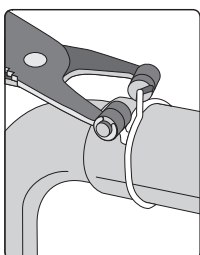
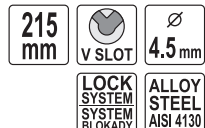

YATO	L (mm)	
YT-0647	215	12/72

GB Hose clamp pliers
D Zange zum Entspannen der Klemmschellen
PL Szczypce do opasek zaciskowych rozprężnych
RUS Щипцы к хомутам зажимным распорным
CZ Kleště na samosvorné hadicové spony
H Vízcsőbilincs fogó

RO Clește pt. benzile de strângere destindere
F Pince pour collier de serrage
I Set pinze per il morsetto
E Pinzas para las abrazaderas de expansión
CN 管夹钳

SLIDING
CARD

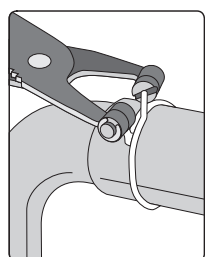
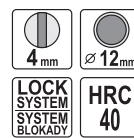

230
mm

YATO	L (mm)	
YT-0650	230	6/36



215
mm

YATO	L (mm)	
YT-0651	215	6/36

GB Exhaust pipe clamp pliers
D Auspuffschellen-Sicherungszange
PL Szczypce do opasek wydechu
RUS Щипцы для пружинных зажимов
CZ Kleště na spony výfuku
H Kipufogóbilincs fogó

RO Clește pt. coliere teava de esapament
F Pince pour collier d'échappement
I Set pinze per il morsetto
E Pinzas para bridas del tubo de escape
CN 排气管夹钳

SLIDING
CARD



300
mm

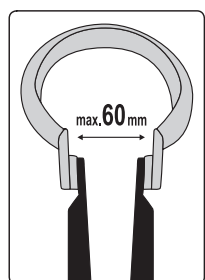

YATO	L (mm)	
YT-0652	300	10/20

for / dla: Peugeot, Citroën,
Renault, Fiat, Ford

- GB** Valve stem seal pliers
- D** Lange Zange für Ventildichtringe
- PL** Szczypce do uszczelniaczy zaworowych, długie
- RUS** Щипцы для замены маслосъемных колпачков
- CZ** Kleště na těsnění ventilů, dlouhé
- H** Szelepszár szimering fogó hosszú

- RO** Clește cu picior lung pt. sigilat supape
- F** Pince pour joints de queues de soupapes
- I** Pinza per tenuta anello stelo valvola
- E** Pinzas para juntas de vástago válvula
- CN** 气门油封钳

SLIDING CARD



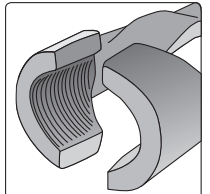

270 mm

FOR VALVE STEM SEALS
(OO USZCZELNACZY ZAWOROWYCH)



NON-SLIP



YATO 	L (mm)	
YT-0648	270	12/60

- GB** Pliers for band clips with a cord
- D** Zange für Rohrschellen mit Seil
- PL** Szczypce z linką do oprasek zaciskowych
- RUS** Щипцы к зажимным хомутом с тросиком
- CZ** Kleště s lankem na samosvorné hadicové spony
- H** Flexibilis bowdenes vízcsőbilincs fogó
- RO** Clește pt. cleme de prindere frânghie

- F** Pince pour collier de serrage
- I** Pinza per il montaggio e lo smontaggio delle clips elastiche
- E** Pinzas para bandas de apretadura con cuerda
- CN** 延长型弹性管夹钳

SLIDING CARD



CrMo 4140

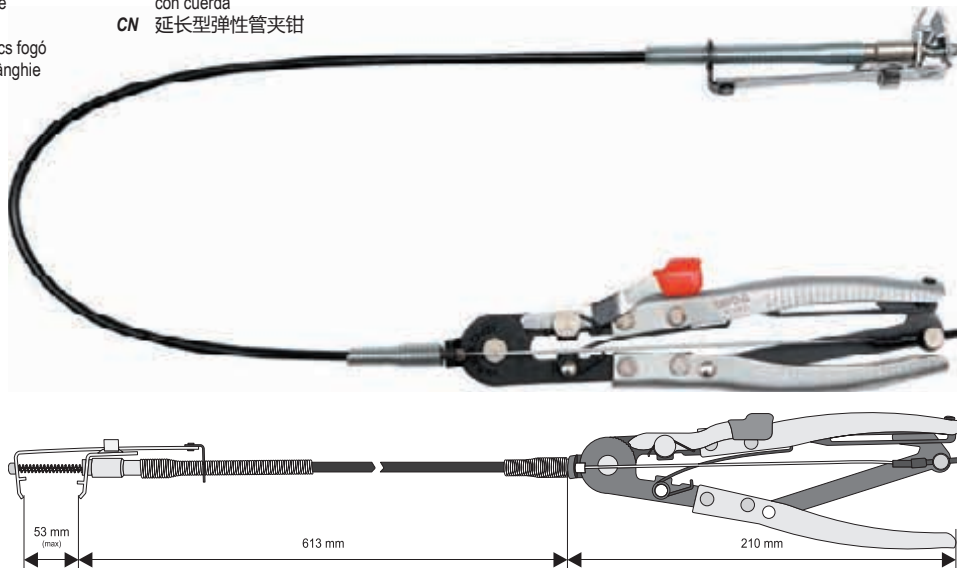

YATO 	
YT-0653	12/36

- GB** Pliers for band clips with a cord
- D** Zange für Rohrschellen mit Seil
- PL** Szczypce z linką do oprasek zaciskowych
- RUS** Щипцы к зажимным хомутом с тросиком
- CZ** Kleště s lankem na samosvorné hadicové spony
- H** Flexibilis bowdenes vízcsőbilincs fogó
- RO** Clește pt. cleme de prindere frânghie
- F** Pince pour collier de serrage
- I** Pinza per il montaggio e lo smontaggio delle clips elastiche
- E** Pinzas para bandas de apretadura con cuerda
- CN** 延长型弹性管夹钳

SLIDING CARD



CrMo 4140



YATO 	
YT-0677	25

- GB** Hose clip pliers
D Schlauchklemmzange
PL Szczypce do oprasek zaciskowych typu CLIC i CLIC-R
RUS Плоскогубцы для зажима шлангов хомуты, CLIC-R
CZ Kleště na hadicové spony
H Tömélbilincs fogó
RO Cleste furturn clip
F Pince pour collier de serrage
I Pinza per fascetta a CLIC e CLIC-R
E Alicates abrazaderas
CN 压线钳



SLIDING CARD



170 mm

CLIC CLIC-R

YATO	L (mm)	
YT-06475	170	15/60

- GB** Water pump pulley locking wrench
D Schlüssel für die Wasserpumpe
PL Klucz do pompy wodnej
RUS Ключ к водному насосу
CZ Klíč na vodní čerpadlo
H Vízpumpafogó
- RO** Cheie pt. pompe de apă
F Clé de blocage pour pompe à eau
I Chiave per la pompa dell'acqua
E Llave para la bomba de agua
CN 水泵皮带轮扳手

SLIDING CARD



245 mm

285 mm

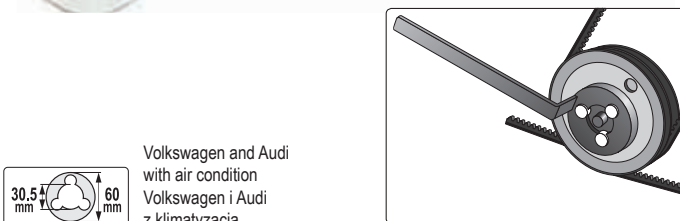
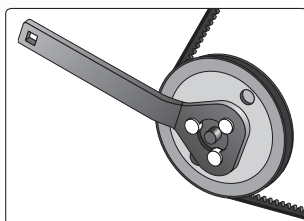

Volkswagen and Audi without air condition
Volkswagen i Audi bez klimatyzacji



Volkswagen and Audi with air condition
Volkswagen i Audi z klimatyzacją

YATO	L (mm)	
YT-0539	245	6/36

YATO	L (mm)	
YT-0540	285	6/36

- GB** Tensioner pulley wrench
D Zahnriemen Spannrollenschlüssel
PL Klucz do rolki napinającej
RUS Ключ для регулировки натяжного
CZ Klíč na napínák
H Bordás szij feszítő
RO Cheie de pretensionare a centurilor
F Clé pour rouleau de tension
I Chiave per il rullo tenditore
E Llave del tensor de la correa dentada
CN 滑轮定时扳手



SLIDING CARD



32 mm

YATO	
YT-06273	20/100

- GB** Universal pulley holder & fan clutch set
D Schlüssel zum Spannen der Riemenscheibe
PL Klucz do napinania koła pasowego
RUS Ключ для натягивания шкива
CZ Klíč k napínání řemenice
H Szíjtárcsa feszítő kulcs
RO Cheie pt. întindere roată de curea
F Clé universelle pour poulie
I Blocca puleggia
E Llave tensora para polea
CN 多用式皮带轮扳手



11 PCS

BMC & COLOR SLEEVE

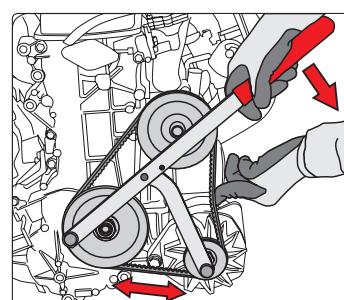

16



Ø 6-10 mm; Ø 8-11 mm;
Ø 10-12 mm; Ø 11-16 mm

YATO	
YT-0627	6

- GB Piston ring compressor
- D Kolbenring-Spannband
- PL Zaciskacz do pierścieni
- RUS Оправка поршневых колец
- CZ Svěrka na kroužky
- H Gyűrűbepattintó
- RO Clește pt. strâns inele
- F Compresseur de segments de piston
- I Morsetto per anelli
- E Apretador de anillos
- CN 活塞环压缩机



AISI # 301

SK5

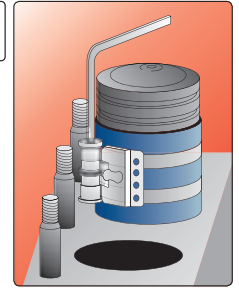

COLOR BOX



YATO	Ø (mm)	H (mm)	
YT-0635	50-125	75	30/60
YT-0636	90-175	100	30/60
YT-0637	90-175	150	20/40

- GB Belt gauge
- D Werkzeug Spannungsprüfer
- PL Przyrząd do kontroli naciągu paska rozrządu
- RUS Прибор для проверки натяжения ремней
- CZ Přípravek pro kontrolu napnutí rozvodového řemene
- H Méter szíjfeszességét
- RO Tester întindere curea de distributie cu gradatie
- F Controleur de tension de courroie
- I Strumento per il controllo rapido della tensione cinghia distribuzione
- E Medidor para determinar la tensión de la correa
- CN 皮带张紧器

COLOR BOX



YATO		
YT-06019		20

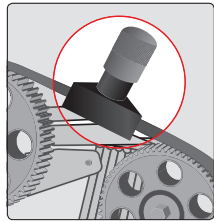

- GB Special socket antechamber injection pump
- D Kerbzahn-Einsatz Für Vorkammer-Muttern an Dieselmotoren
- PL Nasadka do komory wstępnej wirowej
- RUS Сервисный ключ для форкамер
- CZ Klíč pro vstřikovací čerpadla
- H Dugókulcs befecskenező szivattyúhoz
- RO Tubulara speciala pt. anticamera pompa de injectie motoare
- F Douille spéciale pipe d'admission
- I Bussola per precamera
- E Llave de vaso con dentado exterior para cámara de precombustión
- CN 奔驰火花塞外齿套筒

PLASTIC HANGER



1/2"

12.5mm

Ø 28mm

FOR MERCEDES DO MERCEDESA

YATO		
YT-12005		15/60

- GB Twin cam locking tool for petrol & diesel engines
- D Universelle Blockade der Steuerwellen
- PL Uniwersalna blokada wałków rozrządu
- RUS Универсальный набор блокировки распределителя
- CZ Univerzální přípravek na zablokování rozvodných hřídelí
- H Univerzális vezérműtengely rögzítő

- RO Blocadă universală arbore de direcție
- F Outil de blocage d'arbre à cames
- I Universale strumento di bloccaggio a camme
- E Bloqueo universal de eje de distribución
- CN 双凸齿轮固定器

FOR PETROL & DIESEL ENGINES DO SILNIKÓW DIESLA I BENZYNOWYCH

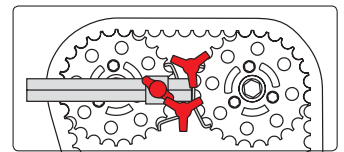

SLIDING CARD

YATO		
YT-06011		10/20

- GB Camshaft locking tool
- D Nockenwellen-Arretierwerkzeug
- PL Przyrząd do blokowania kół rozrządu
- RUS Инструмент для блокирования распределительных механизмов
- CZ Přípravek k montáži rozvodových kol
- H Vezérlés rögzítő szerszám
- RO Arbore cu came
- F Outil de blocage d'arbre à cames
- I Set di serrature di temporizzazione
- E Aparato para bloquear el árbol de levas
- CN 正時皮帶固定器

SLIDING CARD



48 mm

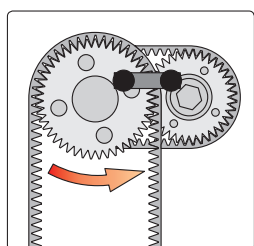

- VW Lupo since 1999
- VW Polo since 1995
- VW Caddy since 1996
- VW Polo Classic since 1996
- VW Polo Variant since 1996
- VW New Beetle 1.4 l
- VW Golf 1.4 l, 1.6 l since 1998
- VW Bora 1.4 l, 1.6 l since 1999

YATO		
YT-0601		6/36

- GB Diesel engine locking setting kit
- D Blockade für die Steuerräder
- PL Blokada do kół rozrządu
- RUS Блокировка к колесам распределительных механизмов
- CZ Souprava na fixaci rozvodových kol
- H Diesel motor rögzítő készlet

- RO Blocadă roților distribuție
- F Outil de blocage d'arbre à cames
- I Cinghia di distribuzione di bloccaggio
- E Bloqueo para las poleas del mecanismo de distribución
- CN 正时皮带更换工具

3 PCS

FOR VALVE TRAIN DO UKLADU ROZRZĄDU

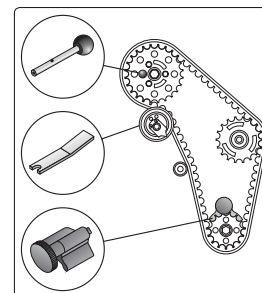

- VW: Lupo, Polo, Golf / Bora, Beetle, Caddy, Sharan, Touran, Transporter (1998-2006);
- AUDI: A2, A3, A4, A6;
- FORD: Galaxy (2000-2006);



- SEAT: Arosa, Ibiza, Cordoba, Leon, Toledo, Alhambra (1999-2005);
- SKODA: Fabia, Octavia (2000-2006)
- 3 i 4 cyl 1.2, 1.4, 1.9 TDI PD
- 2.0 SDI, 2.0 TDI PD

SLIDING CARD

YATO		
YT-0632		10/40

GB Timing locking set
D Arretierwerkzeugsatz für Nockenwellen
PL Zestaw blokad rozrządu
RUS Набор блокировок к колесам распределительных механизмов
CZ Blokovací sada pro opravy rozvodů
H Vezérműrögítő szerszámkészlet
RO Set blocare distributie auto
F Outil de blocage d'arbre à cames
I Set di bloccaggio distribuzione auto
E Juego de bloques de distribución
CN 正时皮带固定器组套



3
PCS

FOR VALVETRAIN DO UKŁADU ROZRZĄDU

FOR DIESEL ENGINES DO SILNIKÓW DIELA

FOR GASOLINE ENGINES DO SILNIKÓW BENZYNOWYCH

APPLICATION:

RENAULT: Twingo, Clio, Kangoo, Megane, Scenic, Laguna, Espace 1.2, 1.4, 1.6, 1.8, 2.0 16v (98-06), 1.5dCi;
NISSAN: Micra 1.5dCi, Kubistar 1.6 16v (03-06); **OPEL:** Vivaro 2.0 16v (01-06)

ZASTOSOWANIE:

RENAULT: Twingo, Clio, Kangoo, Megane, Scenic, Laguna, Espace 1.2, 1.4, 1.6, 1.8, 2.0 16v (98-06), 1.5dCi;
NISSAN: Micra 1.5dCi, Kubistar 1.6 16v (03-06); **OPEL:** Vivaro 2.0 16v (01-06)



ENGINE CODES:

RENAULT: D4F, K4J, K4M, F4P F4R, F4Rt, F5R740, K9K;
NISSAN: K9K, K4M; **OPEL:** FR4 720

SILNIKI O KODZIE:

RENAULT: D4F, K4J, K4M, F4P F4R, F4Rt, F5R740, K9K;
NISSAN: K9K, K4M; **OPEL:** FR4 720

YATO	
YT-06014	10

GB Timing locking set
D Arretierwerkzeugsatz für Nockenwellen
PL Zestaw blokad rozrządu
RUS Набор блокировок к колесам распределительных механизмов
CZ Blokovací sada pro opravy rozvodů

H Vezérműrögítő szerszámkészlet
RO Set blocare distributie auto
F Outil de blocage d'arbre à cames
I Set di bloccaggio distribuzione auto
E Juego de bloques de distribución
CN 正时皮带固定器组套

4
PCS

FOR VALVETRAIN DO UKŁADU ROZRZĄDU

FOR GASOLINE ENGINES DO SILNIKÓW BENZYNOWYCH

DROP FORGED KUTE

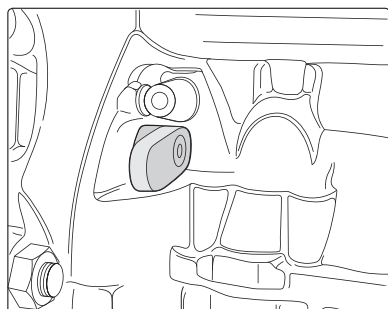
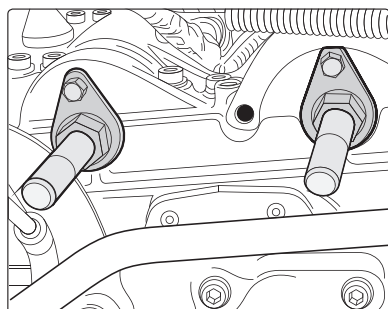

Timing locking set for engines 1.2 6V / 12V (chain)

Zestaw blokad rozrządu silników 1.2 6V / 12V (łańcuch)

APPLICATION:

VW, SKODA, SEAT 1.2 12V and 1.2 6V (HTP);
VW: Polo;
SEAT: Ibiza, Cordoba;
SKODA: Fabia HTP;
Engine codes AZQ, AWY, BMD, BME (02-07).

ZASTOSOWANIE:

VW, SKODA, SEAT 1.2 12V i 1.2 6V (HTP);
VW: Polo;
SEAT: Ibiza, Cordoba;
SKODA: Fabia HTP;
Silniki o kodzie AZQ, AWY, BMD, BME (02-07).

SET INCLUDES:

- camshaft locking pin 1 pc
- crankshaft locking pin 1 pc
- camshaft locking clamps 2 pcs

ZESTAW ZAWIERA:

- trzpień blokujący wałek rozrządu 1 szt.
- trzpień blokujący wał korbowy 1 szt.
- zacisk blokujący wałki rozrządu 2 szt.



YATO	
YT-06012	10

- GB** Timing locking set
- D** Arretierwerkzeugsatz für Nockenwellen
- PL** Zestaw blokad rozrządu
- RUS** Набор блокировок к колесам распределительных механизмов
- CZ** Blokovací sada pro opravy rozvodů
- H** Vezérműrgyítő szerszámkészlet
- RO** Set blocare distributie auto
- F** Outil de blocage d'arbre à cames
- I** Set di bloccaggio distribuzione auto
- E** Juego de bloques de distribución
- CN** 正时皮带固定器组套

APPLICATION:

FIAT: 500, Panda, Punto, Grande Punto, Albea, Linea, Bravo, Brava, Palio, Idea, Weekend, Siena, Stilo, Marea (97-10); **LANCIA:** Ypsilon, Musa (96-10)

ENGINE CODES:

1.2 16V - 176B9.000, 182B2.000, 188A5.000, 1.4 16V - 843A1.000, 169A3.000, 192B2.000, 198A1.000, 198A4.000, 199A6.000

ZASTOSOWANIE:

FIAT: 500, Panda, Punto, Grande Punto, Albea, Linea, Bravo, Brava Palio, Idea, Weekend, Siena, Stilo, Marea (97-10); **LANCIA:** Ypsilon, Musa (96-10)

SILNIKI O KODZIE:

1.2 16V - 176B9.000, 182B2.000, 188A5.000, 1.4 16V - 843A1.000, 169A3.000, 192B2.000, 198A1.000, 198A4.000, 199A6.000



5
PCS

FOR VALVE TRAIN
DO UKŁADU
ROZRZĄDU

FOR GASOLINE
ENGINES
DO SILNIKÓW
BENZYNOWYCH

BMC
& COLOR
SLEEVE



YATO	
YT-06016	10

- GB** Timing locking set
- D** Arretierwerkzeugsatz für Nockenwellen
- PL** Zestaw blokad rozrządu
- RUS** Набор блокировок к колесам распределительных механизмов
- CZ** Blokovací sada pro opravy rozvodů
- H** Vezérműrgyítő szerszámkészlet
- RO** Set blocare distributie auto
- F** Outil de blocage d'arbre à cames
- I** Set di bloccaggio distribuzione auto
- E** Juego de bloques de distribución
- CN** 正时皮带固定器组套

APPLICATION:

OPEL: Astra, Vectra, Signum, Zafira, 1.9 CDTi (04 - 06);
FIAT: 1.9, 2.4 JTD; 16v, 20v;

ALFA ROMEO: 147, 156, GT 1.9 JTD 16v, 2.4 JTD 20v

ENGINE CODES:

OPEL: Z19DTH, Z19DT;

ALFA ROMEO: 192 A5.000, 192 B1.000, 937 A4.000, 937 A5.000

ZASTOSOWANIE:

OPEL: Astra, Vectra, Signum, Zafira, 1.9 CDTi (04 - 06);

FIAT: 1.9, 2.4 JTD; 16v, 20v.; **ALFA ROMEO:** 147, 156, GT 1.9 JTD 16v, 2.4 JTD 20v

SILNIKI O KODZIE:

OPEL: Z19DTH, Z19DT; **ALFA ROMEO:** 192 A5.000, 192 B1.000, 937 A4.000, 937 A5.000



6
PCS

FOR VALVE TRAIN
DO UKŁADU
ROZRZĄDU

FOR DIESEL
ENGINES
DO SILNIKÓW
DIELSA

BMC
& COLOR
SLEEVE



YATO	
YT-06013	10

- GB** Timing locking set
- D** Arretierwerkzeugsatz für Nockenwellen
- PL** Zestaw blokad rozrządu
- RUS** Набор блокировок к колесам распределительных механизмов
- CZ** Blokovací sada pro opravy rozvodů
- H** Vezérműrgyítő szerszámkészlet
- RO** Set blocare distributie auto
- F** Outil de blocage d'arbre à cames
- I** Set di bloccaggio distribuzione auto
- E** Juego de bloques de distribución
- CN** 正时皮带固定器组套









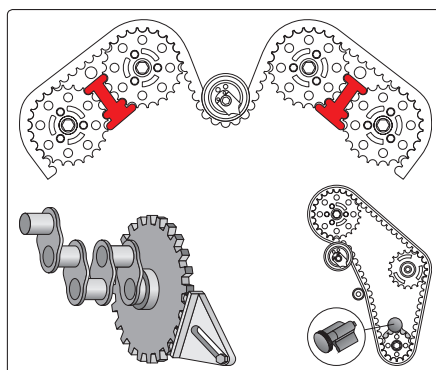

8
PCS

AI

BMC
& COLOR
SLEEVE



YATO	No.	No.	
YT-0633	 Vauxhall/Opel: ASTRA G 1.7 TD, ASTRA G 2.0 16V, VECTRA 1.8/2.0 16V > 1995		Volkswagen: BORA 1.9TDI, GOLF 1.9TDI, LUPO 1.2/1.4/3.0 TDI, POLO 1.4TDI PASSAT 1.9TDI
	 Vauxhall/Opel: ASTRA G 1.4/1.6/1.8 16V > 1994, VECTRA 1.6/1.8 16V, ZAFIRA 1.6/1.8 16V		Citroen: BERLINGO 1.9D, DISPATCH 1.9D/TFD-FSO 1.9D, RELAY 1.9D/TFD, SYNERGIE 1.9/2.0T, SANTIA 1.9/2.0 D/TFD/HDI, XSARA 1.9/2.0 D/HDI, ZX 1.9D/TFD, most diesels Fiat: DUCATO 2.0D, ULYSSE 1.8/2.0 TURBO Ford: most diesels Peugeot: 205 1.6/1.8/1.9D, 305 1.6/1.8/1.9D, 306 1.8/1.9D/TFD, 309 1.6/1.9D-4.5 1.6/1.9D, 406 1.9D, 605 2.0D/TFD, 806 1.9D, Boxer: 1.9/2.0 D/TFD, EXPERT 1.9D, PARTNER 1.9D Talbot: EXPRESS D, HORIZON D-J5 D, SOLARA D
	 right hand camshaft Saab: 900-9000 Vauxhall/Opel: CALIBRA 2.5/2.5i/2.6 V6, CAVALIER 2.5i V6, OMEGA B 2.5/2.6/3.0/3.2 V6, SINTRA 3.0 V6, VECTRA A 2.5i/2.6 V6		
	 left hand camshaft Saab: 900-9000 Vauxhall/Opel: CALIBRA 2.5/2.5i/2.6 V6, CAVALIER 2.5i V6, OMEGA B 2.5/2.6/3.0/3.2 V6, SINTRA 3.0 V6, VECTRA A 2.5i/2.6 V6		
	 Rover: 25 1.4/1.6/1.8/VVC, 45 1.4/1.6/1.8, 75 1.8, 200 VI, 214 16V, 216 16V/CABRIO/COUPE, 218 COUPE, 414 16V, 416 16V, BRM 1.8VVC		Isuzu: 1.5/1.7 diesel engines Vauxhall/Opel: 1.6/1.7 diesel engines, 1.2/1.4/1.6/1.8/2.0 OHC petrol engines

GB Timing locking set for V.A.G.
D Einstellwerkzeug Zahnriemen nockenwellen
Arretierwerkzeug steuerriemen für V.A.G.
PL Zestaw blokad rozrządu dla V.A.G.
RUS Набор блокировок газораспределения V.A.G.

CZ Sada aretacie rozvodov pro V.A.G.
H Vezérműrgztítő készlet, V.A.G. - hoz
RO Set blocare distributie auto pt. V.A.G.
F Outil de blocage d'arbre à cames

I Set di bloccaggio distribuzione auto
E Juego de bloqueos de distribucion para V.A.G.
CN 大众&奥迪正时工具

34
PCS

FOR / DLA
V.A.G.

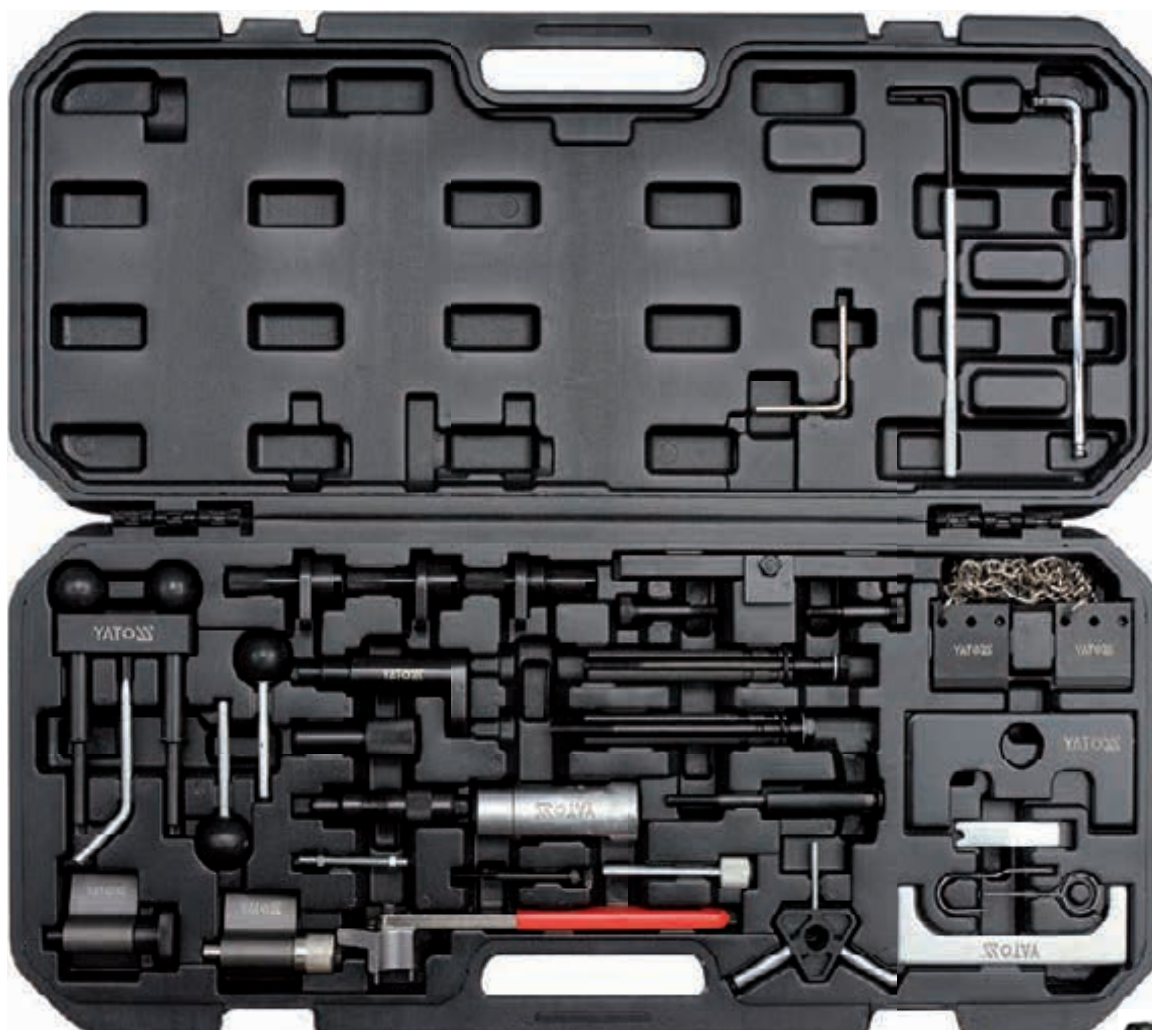

BMC
& COLOR
SLEEVE



YATO	
YT-06015	4

GB Timing locking set for V.A.G.
D Einstellwerkzeug Zahnriemen nockenwellen
Arretierwerkzeug steuerriemen für V.A.G.
PL Zestaw blokad rozrządu dla V.A.G.
RUS Набор блокировок газораспределения V.A.G.
CZ Sada aretacie rozvodov pro V.A.G.
H Vezérműrgztítő készlet, V.A.G. - hoz
RO Set blocare distributie auto pt. V.A.G.
F Outil de blocage d'arbre à cames
I Set di bloccaggio distribuzione auto
E Juego de bloqueos de distribucion para V.A.G.
CN 大众&奥迪正时工具



4
PCS

FOR VALVETRAIN
DO UKŁADU
ROZRZĄDU

FOR GASOLINE
ENGINES
DO SILNIKÓW
BENZYNOWYCH

16

APPLICATION / ZASTOSOWANIE:

AUDI: A3 (03-10); SEAT: Altea, Ibiza, Leon;
SKODA: Fabia II (07-09), Octavia (04-09), Roomster (06-09), Superb (09-10);
VW: Eos (06-09), Golf (03-09), Golf Plus (05-09), Jetta (06-09), Passat (05-09),
Polo (02-08), Scirocco (09-10), Tiguan (07-09), Touran (03-09)

ENGINE CODES / SILNIKI:

1.4 FSI: (AXU, BKG, BLN)
1.4 TFSI: (BLG, BMY, BWK, CAVA, CAVB,
CAVC, CAVD, CAVF, CAXA, CAXC, CDGA)
1.6 FSI: (BAG, BLF, BLP, BTS)

BMC
& COLOR
SLEEVE



YATO	
YT-06017	10

- GB** Wire brush set
- D** Bürsten Sortiment
- PL** Zestaw szczotek do gniazd wtryskiwaczy
- RUS** Ерши с наружной резьбой в наборе
- CZ** Rourové kartáče válcové
- H** Henger drótkefe
- RO** Perii cilindrice pt. curatarea gaurilor
- F** Brosse cylindrique
- I** Vetro di protezione
- E** Cepillos para limpieza interior
- CN** 件套清洁组



20 PCS	150 mm	1/4" 6.3mm	9,11,13 15,17,19 mm
NYLON	STAINLESS STEEL STAL NEROZEWNA	BRASS MOSIADZ	



NYLON CASE & COLOR BOX

YATO	
YT-08195	24

- GB** Diesel injector puller
- D** Stoßabziehvorrichtung für Einspritzdüse
- PL** Ściągacz bezwładnościowy do wtryskiwaczy
- RUS** Ударный съемник форсунок
- CZ** Rázový vyťahovač vstřikovačů
- H** Diesel poriasztó kisedő
- RO** Dispozitiv de scos injectoare
- F** Extracteur à choc d'injecteurs
- I** Martello scorrevole per la rimozione degli iniettori
- E** Tuerca tensora de impacto para inyectoros
- CN** 柴油喷油嘴拔取器

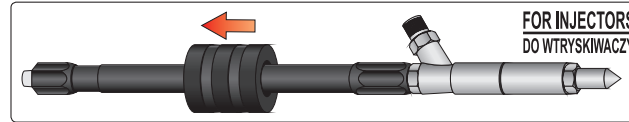

FOR INJECTORS DO WTRYSKIWACZY	BOSCH TYPE
	LUCAS TYPE
	M8 M12 M14



BMC & COLOR SLEEVE

YATO	
YT-0617	20

- GB** Diesel injector master removal kit
- D** Injektor Auszieher Abzieher Werkzeug Einspritzdüsen
- PL** Zestaw ściągaczy bezwładnościowych do wtryskiwaczy
- RUS** Съемник форсунок с ударным молотком для дизельных двигателей
- CZ** Souprava na demontáž vstřikovačů s reverzním kladivem
- H** Injektor kihúzó készlet, csúszókalapáccsal
- RO** Set de extractoare inertiiale pt. injectoare
- F** Coffret extracteur d'injecteur
- I** Set di estrattori ad inerzia per iniettori
- E** Extractor de inyectoros de inyección
- CN** 24件套柴油喷嘴维修工具



22 PCS	1/2" 12.5mm	BOSCH DELPHI DENSO SIEMENS
	PUMP GUSE DIESEL INJECTORS	2 HAMMERS
	POMPY WTRYSKIWACZY	2 MLCZY



BMC

YATO	
YT-06175	1

- GB** Overhead valve spring compressor
- D** Vorrichtung zur Demontage von Motorventilen
- PL** Przyrząd do demontażu zaworów silnikowych
- RUS** Устройство для демонтажа клапанов двигателя
- CZ** Přípravek na demontáž ventilů motoru
- H** Szeleplehúzó készülék
- RO** Dispozitiv pt. demontarea supapelor la motoare
- F** Outil pour démonter les soupapes de moteur
- I** Strumento per la rimozione di valvole motore
- E** Instrumento para desmontaje de válvulas de motor
- CN** 下压式凡尔钳



SLIDING CARD

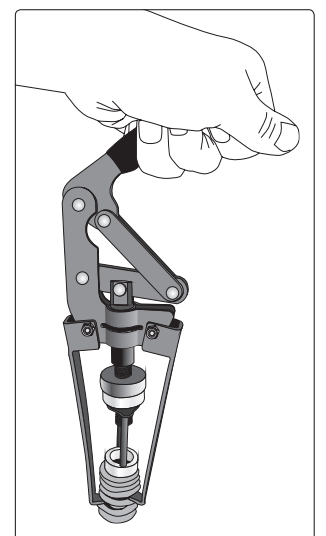

YATO	
YT-0618	5/25

- GB** Lambda sensor thread chaser
D Lambdasonde gewinde reparatur-set
PL Zestaw do naprawy gwintów sondy lambda
RUS Набор для ремонта сорванной резьбы винтов
CZ Sada na opravu závitů Lambda sondy
H Menetjavító készlet Lambda szondához
RO Dispozitiv pt. curatat filet sonda lambda
F Set de réparation filetage de sonde lambda
I Chiavi a bussola per sonda lambda
E Cazador del hilo de rosca para sonda lambda
CN 火星塞丝攻组套

FOR OXYGEN SENSOR DO SONDY LAMBDA

HRC 50

M12 x 1.25

M18 x 1.5



SLIDING CARD

YATO	
YT-1756	12/96

- GB** Oxygen sensor crowfoot wrench
D Schlüssel für die Lambdasonde
PL Klucz do sondy lambda
RUS Ключ для зонда лямбда
CZ Klíč na sondu lambda
H Lambda szonda kulcs
RO Cheie pt. sonda lambda
F Clé pour sonde lambda
I Chiave per sonde lambda
E Llave para la sonda lambda
CN 氧传感器套筒扳手

SLIDING CARD

22 mm



FOR OXYGEN SENSOR DO SONDY LAMBDA



CrMo SCM440



YATO	
YT-1753	15/60



CrV 50BV30

YATO	
YT-1754	6/36

- GB** Socket and oxygen sensor set
D Steckschlüssel für die Lambda-Sonde
PL Klucze nasadowe do sondy lambda
RUS Торцовые ключи с внутренним многогранником для зонда лямбда
CZ Nástrčné klíče na sondy lambda
H Dugókulcs lambda szondához
RO Prize pt. sonda lambda
F Douille pour sonde lambda
I Set di riparazione per filetti di sonde lambda
E Llaves de cubo para la sonda lambda
CN 氧传感器套筒扳手组套

-  22 mm; L= 50 mm; 6PT; CrMo SCM440;
 22 mm; L=30 mm; 6PT; CrMo SCM440;
 22 mm; L=80 mm; 6PT; CrV 50BV30









3 PCS 22 mm FOR OXYGEN SENSOR DO SONDY LAMBDA
CrMo SCM440 CrV 50BV30

BMC & COLOR SLEEVE

YATO	
YT-1752	20

- GB** Oxygen sensor and fuel injectors wrench set
D Steckschlüsselsatz für die Lambdasonde und die Einspritzdüsen
PL Zestaw nasadek do sondy lambda i wtryskiwaczy
RUS Набор насадок к лямбда-зондам и форсункам
CZ Sada nástavců na demontáž sondy lambda a vstříkovačů
H Dugókészlet lambda szondákhoz és injektorokhoz
RO Set inelare pt. sonda lambda și injectoare
F Douilles pour sonde lambda et injecteurs
I Set di riparazione per filetti di sonde lambda
E Juego de boquillas para la sonda lambda y para inyectoros
CN 氧传感器套筒扳手组套

-  1/2" (12.7 mm) x 29 mm; L=90 mm; 6PT;
 3/8" (9.5 mm) x 22 mm; L=90 mm; 6PT;
 1/2" (12.7 mm) x 27 mm; L=78 mm; 12PT;
 3/8" (9.5 mm) x 27 mm; L=74 mm; 6PT;
 3/8" (9.5 mm) x 22 mm; L=80 mm; 6PT;
 1/2" (12.7 mm) x 22 mm; L=50 mm; 6PT;
 3/8" (9.5 mm) x 22 mm; L=30 mm; 6PT



7 PCS 1/2" 12.5mm 3/8" 10mm
CrMo SCM440 CrV 50BV30 FOR OXYGEN SENSOR DO SONDY LAMBDA

FOR FUEL INJECTORS DO WTRYSKÓW PALIWA

BMC & COLOR SLEEVE

YATO	size / rozmiar	
YT-1751	1/2" (12.7 mm) 3/8" (9.5 mm)	5

- GB** Diesel injection socket set
- D** Aufsätze für die Einspritzungen bei Dieselmotoren
- PL** Zestaw nasadek do wtrysków w silnikach Diesla
- RUS** Набор насадок к форсункам в дизельных двигателях
- CZ** Sada nástavců na trysky dieselových motorů
- H** Szerszámkészlet Dieselmotor befecskendezőkhöz
- RO** Set de capete pt. injectoare in motoare Diesel
- F** Set des douilles pour injecteurs (diesel)
- I** Set di custodie per i motori diesel
- E** Juego de tapones para las inyecciones en los motores de Diesel
- CN** 柴油机加注套筒组套



6 PCS	1/2" 12.5mm
AS-DRIVE	CrV
FOR FUEL INJECTORS DO WTRYSKÓW PALIWA	

BMC & COLOR SLEEVE



21x90; 22x78; 22x110; 27x78; 28x78; 28x83 mm

YATO	size / rozmiar	
YT-0622	1/2" (12.7 mm)	10

- GB** Diesel injector and cutter set
- D** Fräsersatz für die Buchsen der Einspritzdüsen
- PL** Zestaw frezów do gniazd wtryskiwaczy common rail
- RUS** Комплект фрез для гнезд сопел форсунки
- CZ** Sada fréz na sedla trysek vstříkovačů
- H** Marókészlet befecskendező fúvókájának fészkéhez
- RO** Set de freze pt. socluri de duze injectoare
- F** Alimentation d'un injecteur de common rail
- I** Set frese per sedi iniettori common rail
- E** Juego de fresas para el asiento de toberas de inyectoros
- CN** 7件套气门铰刀



7 PCS
CrMoV SKD11

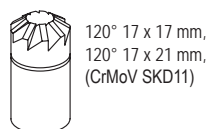
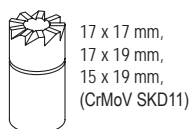
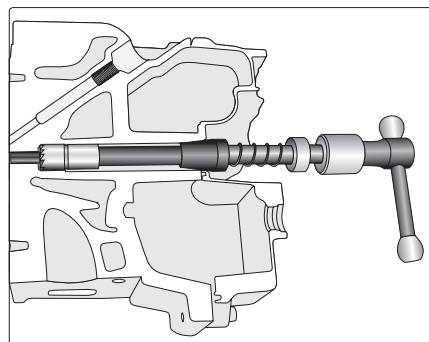

BMC & COLOR SLEEVE



YATO		
YT-17625		10

- GB** Tooth socket for injection nozzle
- D** Stiftschlüsselsatz für die Einspritzdüse in Lastkraftwagen
- PL** Zestaw kluczy czopowych do wtryskiwaczy w samochodach ciężarowych
- RUS** Набор шиповых ключей к форсункам грузовых автомобилей
- CZ** Sada klíčů na vstříkovače pro nákladní automobily
- H** Csapokulcs készlet tehergépkocsi befecskendezőjéhez
- RO** Set chei tubulare cu ungera pt. camioane
- F** Set de douilles injecteurs
- I** Set di chiavi per iniettori camion
- E** Juego de llaves de muñon para los inyectoros en camiones
- CN** 卡车喷油嘴套筒组套



4 PCS	1/2" 12.5mm	HEX
CrMo	S45C	CrV
FOR FUEL INJECTORS DO WTRYSKÓW PALIWA		

BMC & COLOR SLEEVE



- ⊙ 1/2" (12.7 mm); L=72 mm; 4T; CrV;
- ⊙ 32 mm; M14 x 1.5 mm; L=70 mm, 4T; S45C;
- ⊙ 1/2" (12.7 mm); L=120 mm; 3T; CrMo;
- ⊙ 32 mm; L=120 mm, 4T; S45C

YATO	size / rozmiar	
YT-1762	1/2" (12.7 mm)	16

- GB** Fuel injection test kit
D Diagnosesatz für die Prüfung der Kraftstoffeinspritzung
PL Zestaw diagnostyczny do wtrysku paliwa
RUS Пневматический набор к тормозным зажимам
CZ Souprava k diagnostice vstřikování paliva
H Diagnosztikai készlet üzemanyag - befecskendőzökhöz
RO Ansamblu pt. diagnosticarea injectiei combustibilului
F Kit de test de débit d'injecteur
I Set diagnostico per iniettori la benzina
E Juego de herramientas diagnosticas para la inyección de combustible
CN 燃料注射测试组套

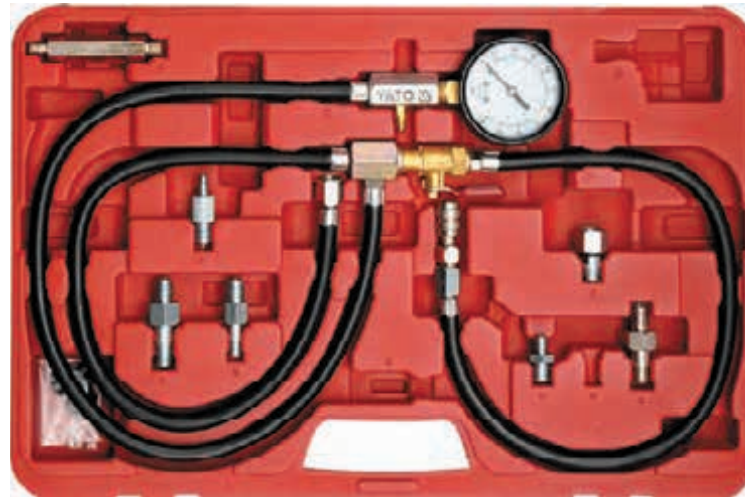

10
PCS

P max.
0.7 MPa

BMC
& COLOR
SLEEVE



YATO
YT-0670 10

- GB** Compression pressure gauge in a diesel engine
D Kompressionsdruckmesser in Dieselmotoren
PL Miernik ciśnienia sprężania w silnikach diesla
RUS Измеритель давления компрессии в дизельных двигателях
CZ Souprava k měření kompresních tlaků v dieslových motorech
H Dieselmotorok kompresszióját mérő óra
RO Manometru presiunii aerului comprimat pt. motoarele diesel
F Testeur de pression cylindrique diesel
I Tester prova compressione motori diesel
E Medidor de presión de la compresión en los motores diesel
CN 柴油机压力测试组套



16
PCS

70 bar
max.

FOR DIESEL
ENGINE
DO SILNIKÓW
DIESEL

BMC
& COLOR
SLEEVE



YATO
YT-7307 5

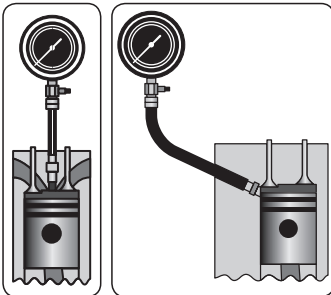

70 bar, 500 mm;

160 mm;

M20x1.5: 75 mm; M22x1.5: 73 mm; M24x1.5: 88 mm; M24x2: 63 mm;

M10x1: 83, 91, 102, 113, 119 mm; M10x1.25: 64, 135 mm; M12x1.25: 47 mm; M22x1.5: 118 mm;

- GB** Oil pressure tester
D Öldruckanzeige
PL Miernik ciśnienia oleju
RUS Тестер давления масла с адаптерами
CZ Tester tlaku oleje
H Olajnyomásmérő készlet
RO Tester presiune ulei
F Set de testeurs de pression d'huile
I Tester misurazione pressione dell'olio
E Manómetro de aceite
CN 自动波箱压力表

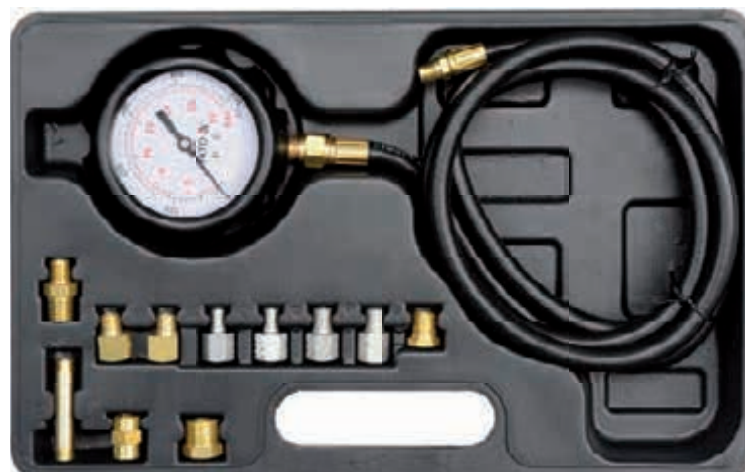

12
PCS

185 cm
HOSE
WAZ

FOR ALL TYPES
OF ENGINES
DO WSZYSTKICH
TYPOW SILNIKÓW

0-35 bar

0-500 PSI

BMC
& COLOR
SLEEVE



YATO
YT-73030 10

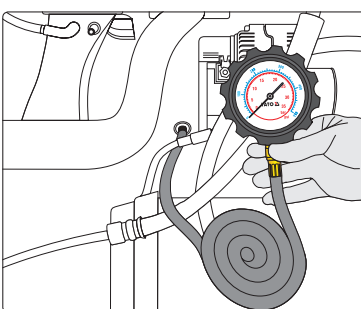

- | | | |
|---------------------------------------|--|--------------------------------|
| GB Compression tester | CZ Měřicí přístroj kompresního tlaku | I Monometro pressione |
| D Druckluftmessgerät | H Kompresszió mérő | E Medidor de compresión |
| PL Miernik ciśnienia sprężania | RO Aparat de măsurarea presiunii | CN 气缸压力表 |
| RUS Тестер компрессии | F Testeur de pression adaptateur cône | |

FOR ALL TYPES
DO WSZYSTKICH TYPÓW

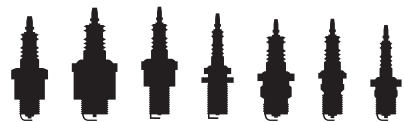

21 bar max.

FOR SPARK IGNITION DO ZAPŁONU ISKROWEGO

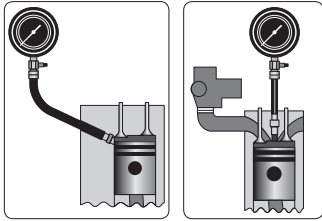

BMC & COLOR SLEEVE

RUBBER ADAPTOR ZŁĄCZE GUMOWE



THREADED ADAPTOR ZŁĄCZE GWINTOWANE



THREADED ADAPTOR ZŁĄCZE GWINTOWANE

RUBBER ADAPTOR ZŁĄCZE GUMOWE



YATO	
YT-7300	24/48

YATO	
YT-7301	12/24

YATO	
YT-7302	6/24

- | |
|---|
| GB Flow meter common rail adapter set |
| D Überlauf-Diagnosesatz für die Einspritzdüse Common rail |
| PL Przelewowy zestaw diagnostyczny do wtryskiwaczy common rail |
| RUS Диагностический набор к форсункам common rail; переливной |
| CZ Souprava na diagnostiku vstřikovačů common rail, průtoková |
| H Diagnosztikai készlet common rail injektorokhoz, átfolyós |
| RO Set diagnostic preaplin pt. injectoare common rail |
| F Kit de test de débit d'injecteur common rail |
| I Set controllo portata iniettori common rail |
| E Juego diagnóstico de flujo para inyectoros common rail |
| CN 柴油燃油喷嘴检测工具 |

31 PCS

FOR 6 CYLINDERS DO 6 CYLINDRÓW

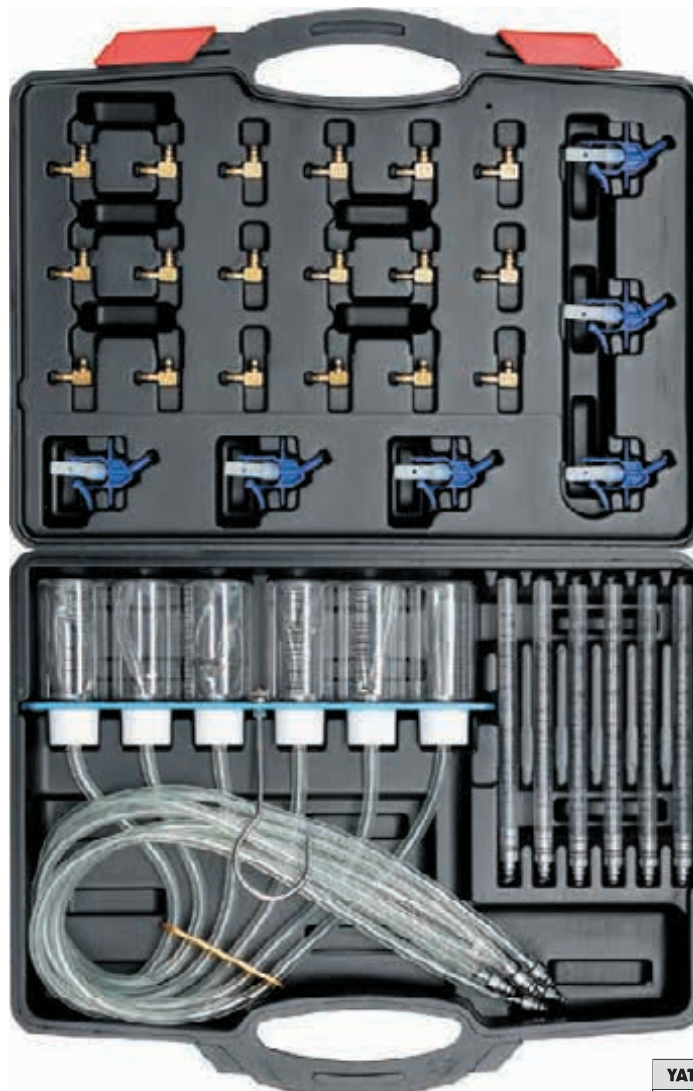

BMC & COLOR SLEEVE

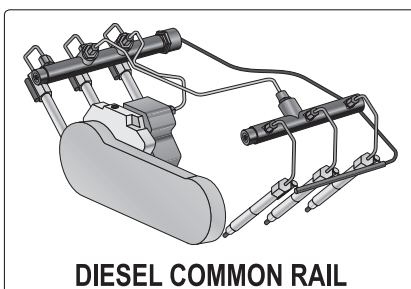

YATO	
YT-7306	5

GB Combined sockets for alternator
D Werkzeugsatz für Lichtmaschine
PL Zestaw do alternatorów ze sprzęgłem
RUS Набор для альтернатора
CZ Souprava na opravu alternátoru
H Generátor szerszámkészlet
RO Garnitură pt. alternator

F Set de clés à l'alternateur avec l'embrayage
I Set di chiavi per smontaggio puleggia e alternatore
E Enchufes combinados para alternador
CN 发动机拆卸组套

13
PCS

1/2"
12.5mm



CrV

HRC
40-44

S45C

HRC
38-42

STEEL
8660

HRC
53-57

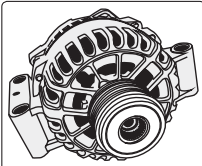

**FOR ALTERNATORS
DO ALTERNATORÓW**

- 1/2" (12.7 mm): M10, HBS, 33T, L=110 mm; CrV; HRC 40-44;
- 1/2" (12.7 mm): T50, HBS, 33T, L=110 mm; CrV; HRC 40-44;
- M8, M10, L=75 mm; 8660; HRC 53-57;
- T40, T50, L=75 mm; 8660; HRC 53-57;
- H8, H10, L=75 mm; 8660; HRC 53-57;

- H15, 33T, L=30 mm; CrV; HRC 40-44;
- H22, 33T, L=30 mm; CrV; HRC 40-44;
- H22, L=30 mm; S45C; HRC 38-42;
- Ø 35 x 30 mm; CrV; HRC 40-44;
- 1/2" (12.7 mm) x 10 mm; CrV; HRC 40-44



BMC
& COLOR
SLEEVE

YATO	○	
YT-0421	1/2" (12.7 mm)	15

GB Combined sockets for alternator
D Werkzeugsatz für Lichtmaschine
PL Zestaw do alternatorów ze sprzęgłem
RUS Набор для альтернатора
CZ Souprava na opravu alternátoru
H Generátor szerszámkészlet
RO Garnitură pt. alternator

F Set de clés à l'alternateur avec l'embrayage
I Set di chiavi per smontaggio puleggia e alternatore
E Enchufes combinados para alternador
CN 发动机拆卸组套

22
PCS

1/2"
12.5mm



3/8"
10mm

CrV

HRC
40-44

S45C

HRC
38-42

STEEL
8660

HRC
53-57

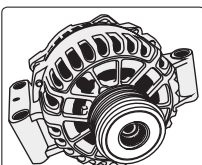

**FOR ALTERNATORS
DO ALTERNATORÓW**

- 1/2" (12.7 mm): M10, HBS, 33T, L=113 mm; CrV; HRC 40-44 / 8660; HRC 53-57;
- 1/2" (12.7 mm): T50, HBS, 33T, L=113 mm; CrV; HRC 40-44 / 8660; HRC 53-57;
- 3/8" (10 mm): M10, HBS, 33T; L=80 mm; CrV; HRC 40-44 / 8660; HRC 53-57;
- 1/2" (12.5 mm): M10, HBS, 33T; L=140 mm; CrV; HRC 40-44;
- M8, M10, L=75 mm; 8660; HRC 53-57;
- T40, T50, L=75 mm; 8660; HRC 53-57;

- H8, H10, L=75 mm; 8660; HRC 53-57;
- M8xH12, L=64 mm; 8660; HRC 53-57;
- H15, 33T, Ø 17 mm, L=30 mm, H15, 33T, Ø 19 mm, L=30 mm, H22, 33T, Ø 19 mm, L=30 mm; CrV; HRC 40-44;
- H17, H22, L=30 mm; S45C; HRC 38-42;
- Ø 35 x 30 mm; S45C; HRC 38-42;
- Ø 38 mm; S45C; HRC 38-42;
- H19x28, H21x28, H22x28; S45C; HRC 38-42;
- 1/2" (12.5 mm) (F) x H10 mm (F); CrV; HRC 40-44



BMC
& COLOR
SLEEVE

YATO	○	○	
YT-04211	1/2" (12.7 mm)	3/8" (9.5 mm)	5

- GB Stroboscopic tube
- D Stroboskoplampe
- PL Lampa stroboskopowa
- RUS Стробоскопная лампа
- CZ Stroboskopická lampka
- H Stroboszkóp lámpa

- RO Lampă stroboscopică
- F Lampe stroboscopique
- I Lampada stroboscopica
- E Tubo estroboscópico
- CN 点火正时灯

DOUBLE BLISTER



12 V

ENGINE SPEED
PREMIUM/2000 RPM
8000 min⁻¹
MAX.

XENON

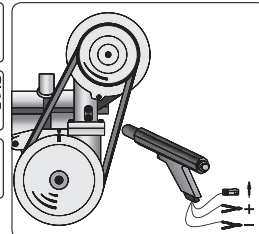

0-60°

YATO	
YT-7310	6/12

YATO	
YT-7311	6/12

YATO	
YT-7312	6/12

- GB Universal radiator pressure kit
- D Diagnosekit für Kühler
- PL Zestaw diagnostyczny do chłodnicy
- RUS Диагностический набор к радиатору
- CZ Souprava k diagnostice chladiče

- H Diagnosztikai készlet hűtőkhöz
- RO Ansamblu pt. diagnosticarea radiatorului
- F Set diagnostique pour radiateur de voiture
- I Set universale tester pressione del radiatore

- E Juego de herramientas diagnosticas para el radiador
- CN 万用水箱压力测试组套

BMC & COLOR SLEEVE



14 PCS

P max. 0.25 MPa

200°C max.

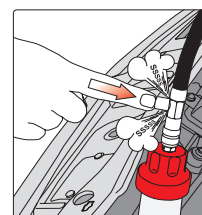
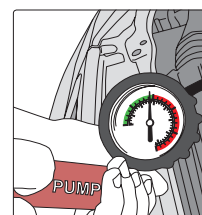
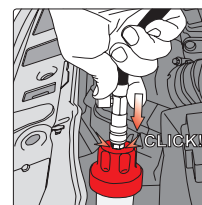

YATO	No.		
YT-0672	2		General Motors
	3		Mercedes, General Motors, Jeep
	4		Peugeot, Subaru, Chrysler, Acura, General Motors, Mitsubishi, Nissan, Mazda, Toyota, Infiniti, GEO, Suzuki, Isuzu, Ford
	5		Honda, Toyota, Suzuki, Mitsubishi, Chrysler, Acura
	6		Audi, BMW, Volkswagen, Porsche
	7		Volvo, Saab, Citroen, Renault, Fiat, Alfa Romeo, Jeep
	8		Volkswagen
	9		Mercedes, General Motors, Jeep
	10		BMW
	11		Audi, Volkswagen
	12		Ford, Land Rover, Opel, Jaguar, Mercedes
	13		Mercedes

- GB** Hand-held vacuum pump
D Unterdruckpumpe mit Zubehör
PL Pompka podciśnieniowa z akcesoriami
RUS Насос вакуумметрического давления с принадлежностями
CZ Podtlaková-tlaková pumpa s příslušenstvím

- H** Vákuum- és ac-pumpa mérő, tartozékokkal
RO Pompa de vidare cu accesorii
F Pompe à vide avec les accessoires
I Pompa a pressione con accessori
E Bomba de subpresión con accesorios
CN 手持式真空泵

16
PCS

-1±0
bar

BMC
& COLOR
SLEEVE



YATO
YT-0673

10

- GB** Hand-held vacuum pump
D Unterdruck-druckpumpe mit Zubehör
PL Pompka ciśnieniowo-podciśnieniowa z akcesoriami
RUS Насос вакуумметрического давления с принадлежностями
CZ Podtlaková-tlaková pumpa s příslušenstvím

- H** Vákuum- és ac-pumpa mérő, tartozékokkal
RO Pompa de vidare cu accesorii
F Pompe à vide avec les accessoires
I Pompa a pressione con accessori
E Bomba de subpresión-presión con accesorios
CN 手持式真空泵

22
PCS

-1±3
bar

BMC
& COLOR
SLEEVE



YATO
YT-0674

5

- GB** Flexible line clamp
D Schlauchklemmensatz
PL Komplet zacisków do przewodów z cieczą
RUS Набор зажимов с фиксатором
CZ Sada hadicových svérek
H Flexibilis cső elszorító készlet
RO Clema flexibila
F Set de pices pour serrer les
I Set pinze per chiudere momentaneamente i manicotti
E Juego de alicates apretadores para conductos de líquidos
CN 油管封口钳组套

SLIDING
CARD



3
PCS

WILL NOT
CUT HOSES
NIE NISZCZY
PRZEWODÓW

NON-CONDUCTIVE
NIEPRZEWODZĄCE



3/4" - 9/4"



1/2" - 5/4"



1/4" - 3/4"



- 1/4" - 3/4" for brake and fuel lines
6.3 - 19.0 mm do przewodów hamulcowych i paliwowych

- 1/2" - 5/4" for flexible hose
12.5 - 32.0 mm do przewodów elastycznych

- 3/4" - 9/4" for radiator hose clamp
19.0 - 57.0 mm do przewodu chłodnicy

YATO
YT-0840

25/50

- GB** Flexible line clamp
D Schlauchklemmensatz
PL Komplet zacisków do przewodów z cieczą
RUS Набор зажимов с фиксатором
CZ Sada hadicových svérek
H Flexibilis cső elszorító készlet
RO Clema flexibila
F Set de pices pour serrer les
I Set pinze per chiudere momentaneamente i manicotti
E Juego de alicates apretadores para conductos de líquidos
CN 油管封口钳组套

SLIDING
CARD



3
PCS

WILL NOT
CUT HOSES
NIE NISZCZY
PRZEWODÓW

BENT
WYGIĘTE

NON-CONDUCTIVE
NIEPRZEWODZĄCE

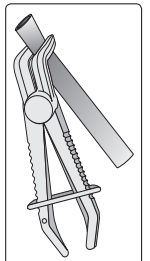

max. 32 mm

max. 17 mm

max. 13 mm

- max. 13 mm for brake and fuel lines
do przewodów hamulcowych i paliwowych

- max. 17 mm for flexible hose
do przewodów elastycznych

- max. 32 mm for radiator hose clamp
do przewodu chłodnicy

YATO
YT-08403

5/15

- GB Spark plug socket
- D Steckschlüssel mit Gummihalterung
- PL Nasadka do świec
- RUS Головка свечная
- CZ Nastavec pro svíčky
- H Gyújtógyertya toldalék
- RO Cheie de bujii
- F Douille à bougies
- I Chiavi a bussola
- E Boquilla de bujías
- CN 六角火花塞套筒

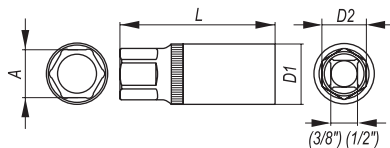

	3/8" 10mm	1/2" 12.5mm
AS-DRIVE	DIN 3121	CrV 50BV30

COLOR BOX



YATO	Ø	A	D1 (mm)	D2 (mm)	L (mm)	PCS packing	
YT-3851	3/8" (9.5 mm)	16.0	22.0	19.0	64.0	10	50/100
YT-1253	1/2" (12.7 mm)	16.0	22.0	19.0	64.0	10	50/100
YT-1254	1/2" (12.7 mm)	21.0	27.8	24.0	64.0	10	50/100

- GB Spark plug socket
- D Kerzenschlüssel mit Verlängerungshebel
- PL Klucz do świec z przedłużką
- RUS Ключ к свечам с удлинителем
- CZ Klíč na svíčky s prodlužovacím nástavcem
- H Gyertyakulcs hosszabbítóval

- RO Cheie cu prelungitor, pt. bujii
- F Douille à bougies
- I Chiavi per candele a tubo
- E Llaves para las bujías con extensión
- CN 火花塞套筒

PLASTIC HANGER



3/8" (10 mm) x 300 mm

CrV 50BV30



YATO	Ø (mm)	
YT-0817	16	10/40
YT-0818	18	10/40
YT-0819	21	10/40

- GB Joined glow plug socket set
- D Schlüsselsatz für Glühkerzen
- PL Zestaw kluczy do świec żarowych
- RUS Набор ключей к калильным свечам
- CZ Sada klíčů na žhavicí svíčky
- H Gyertyakulcs készlet
- RO Set chei pt. bujii incandescente
- F Set de douilles à bougies
- I Set chiavi a bussola snodate per candelette
- E Juego de llaves para bujías incandescentes
- CN 预热火花塞套筒组套



6 PCS

3/8" 10mm

BLOCKING SYSTEM BLOKOWĄCY

8, 9, 10, 12, 14, 16 mm

CrV 50BV30

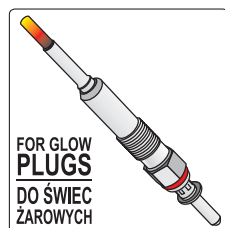

FOR GLOW PLUGS DO ŚWIEC ŻAROWYCH

BMC & COLOR SLEEVE



YATO	Ø	
YT-0534	3/8" (9.5 mm)	10

- GB Torque angle gauge
- D Winkelmesser zum Anziehen von Schrauben
- PL Kątomierz do dokręcania śrub
- RUS Угломер для подвёртывания болтов
- CZ Úhlohměr k utahování šroubů
- H Nyomaték szögmérő
- RO Raportor pt. inşurubat şuruburi
- F Rapporteur à serrer les vis
- I Goniometro per il serraggio controllo
- E Calibrador para apretar tornillos
- CN 扭力角度规



1/2" 12.5mm

360°

CrV

SLIDING CARD



YATO	
YT-0593	12/48

- GB Metal conduit bender
- D Biegevorrichtung für Metallleitungen
- PL Giętarka do przewodów metalowych
- RUS Гибочный станок для проводов из металла

- CZ Ohýbačka kovových trubek
- H Hajlító fémvezetékekhez
- RO Maşina de indoit (curbat) pt. cabluri metalice
- F Cintreuse au câble de frein

- I Piegatrice per fili metallici
- E Dobladora de tubos de metal
- CN 弯管器

SLIDING CARD



AI



125 mm max. Ø 6 mm

235 mm max. Ø 12 mm

YATO	L (mm)	
YT-0813	125	24/96

YATO	L (mm)	
YT-0814	235	6/48

- GB** Universal clutch adjustment set
D Universal-set, um die Kupplungsscheibe einstellen
PL Zestaw do centrowania tarczy sprzęgłowej
RUS Комплект для центровки дисков сцепления
CZ Univerzální sada pro nastavení spojky disk
H Kuplung központosító készlet
RO Trusa pt. centr. ambreiaje
F Centreur d'embrayage
I Set di centraggio frizione
E Herramienta alineación embrague
CN 燭磁動請母漢



9
PCS
∅ mm
11-25

∅ 11, 15, 16.5, 17, 19, 20, 20.5, 25 mm

YATO	
YT-06311	20

- GB** Brake retainer spring tool
D Montagewerkzeug für Bremsfeder
PL Ściągacz sprężynek szcęk hamulcowych
RUS Съёмник для тормозных пружин
CZ Stahovač pružin brzdových čelistí
H Fékrugó szerelő szerszám
RO Dispozitiv pt. montaj arc pe sabot

- F** Extracteur de ressorts freins
I Freno scarpa di fissaggio a molla compressori
E Herramienta para resorte retenedor de frenos
CN 刹车弹簧华司拆装器

SLIDING CARD



FOR DRUM BRAKES DO HAMULCÓW BEBNOWYCH

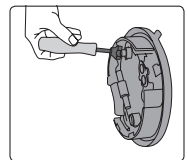

YATO	
YT-0685	12/96

YATO	
YT-0686	12/72

- GB** Brake spring pliers kit
D Bremsbacken-montage set
PL Zestaw do montażu szcęk hamulcowych
RUS Набор инструментов для тормозных пружин

- CZ** Sada na montáž brzdových čelistí
H Fogókészlet fékrugóhoz
RO Dispozitiv pt. inlocuit garnituri cilindrii receptori
F Set pour le montage des mâchoires de freins

- I** Set per montaggio molle freni
E Juego para resortes de frenos
CN 刹车拆卸工具组套

FOR DRUM BRAKES DO HAMULCÓW BEBNOWYCH

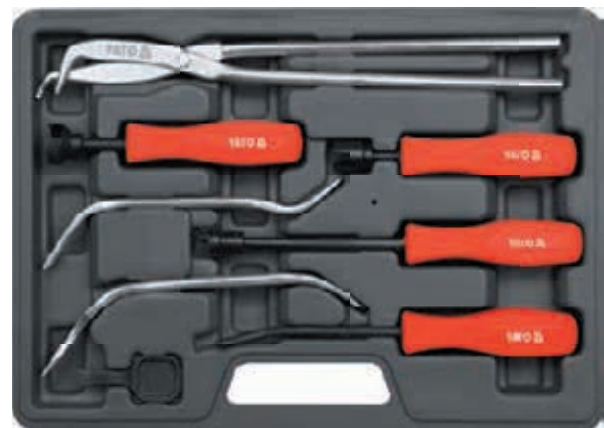
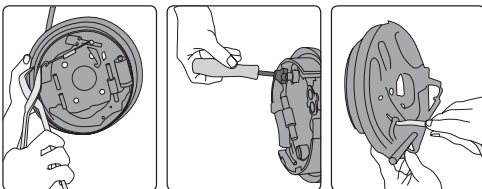

3
PCS

DOUBLE BLISTER

8
PCS

BMC & COLOR SLEEVE

YATO	
YT-0684	6/24

YATO	
YT-0680	5

- GB** Disc brake spreader
D Scheibenbremsen Abscheider
PL Separator do hamulców tarczowych
RUS Распорка тормозных дисков
CZ Přípravek na montáž brzdových prasátek
H Fékmunkahenger visszanyomó
RO Separator disc ambreiaj
F Séparateur des freins à disque
I Separatore per pistoncini freno
E Separador de frenos de discos
CN 刹车片分离器

0-65 mm
1 1/2" (12.5 mm)
21 mm



COLOR BOX

YATO	
YT-0610	12/24

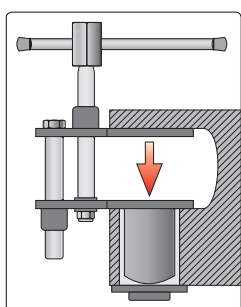

- GB** Disc brake piston tool
D Bremskolbenrücksteller universal
PL Uniwersalny klucz do wkręcania zacisków hamulcowych
RUS Ключ для тормозного поршня
CZ Univerzální klíč k montáži brzdových třmenů
H Féknyereg összenyomó
RO Dispozitiv pt. impins etrier
F Clé universelle pour pinces de frein
I Attrezzo per l'arretamento della pinza dei freni
E Llave para comprimir pistones del freno de disco
CN 刹车分泵拆装器

3/8" CrV
10 mm



SLIDING CARD

YATO	
YT-0683	12/96

for / dia: GM, FORD, Chrysler, VW, Fiat

- GB** Disc brake pad & caliper service tool kit
- D** Werkzeugsatz von manuellen Separatoren für die Bremsklemmen
- PL** Zestaw ręcznych separatorów do zacisków hamulcowych
- RUS** Набор ручных сепараторов для тормозных зажимов
- CZ** Ruční sada na montáž kotoučových brzd
- H** Fékmunkahenger prés készlet
- RO** Set de separatoare manuale pt. etrier frâna
- F** Set de repousse piston de frein
- I** Kit universale regolazione manuale per pistoni freni
- E** Juego de separadores manuales para abrazaderas de freno
- CN** 刹车片分离器组套

11
PCS

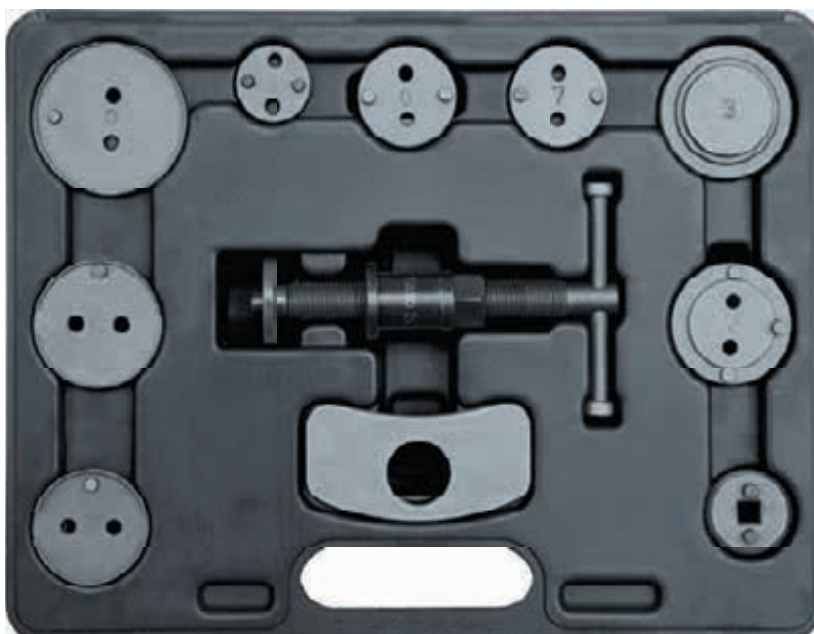

BMC
& COLOR
SLEEVE

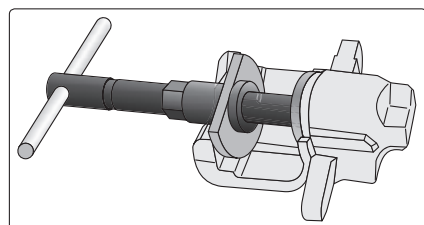

YATO 	No.	zacisk przedni (F)	zacisk tylny (R)	
YT-0681	1-1	siłownik		5
	1	płytki oporowa		
	5	adapter z gniazdem		
	2	Citroen: XM, Xantia		
	3	Alfa Romeo, Audi, Austin, BMW, Honda, Jaguar, MB, Mitsubishi, Nissan, Rover, Toyota, VW		
	4		Ford, Mazda, Subaru, Alfa Romeo, Saab	
	6		Nissan	
	7		Audi, Ford, Honda, Nissan, Rover, Saab, Subaru, VW	
	8	General Motors		
9	General Motors			

- GB** Disc brake pad & caliper service tool kit
- D** Werkzeugsatz von manuellen Separatoren für die Bremsklemmen
- PL** Zestaw ręcznych separatorów do zacisków hamulcowych
- RUS** Набор ручных сепараторов для тормозных зажимов
- CZ** Ruční sada na montáž kotoučových brzd
- H** Fékmunkahenger prés készlet
- RO** Set de separatoare manuale pt. etrier frâna
- F** Set de repousse piston de frein
- I** Kit universale regolazione manuale per pistoni freni
- E** Juego de separadores manuales para abrazaderas de freno
- CN** 刹车片分离器组套

12
PCS

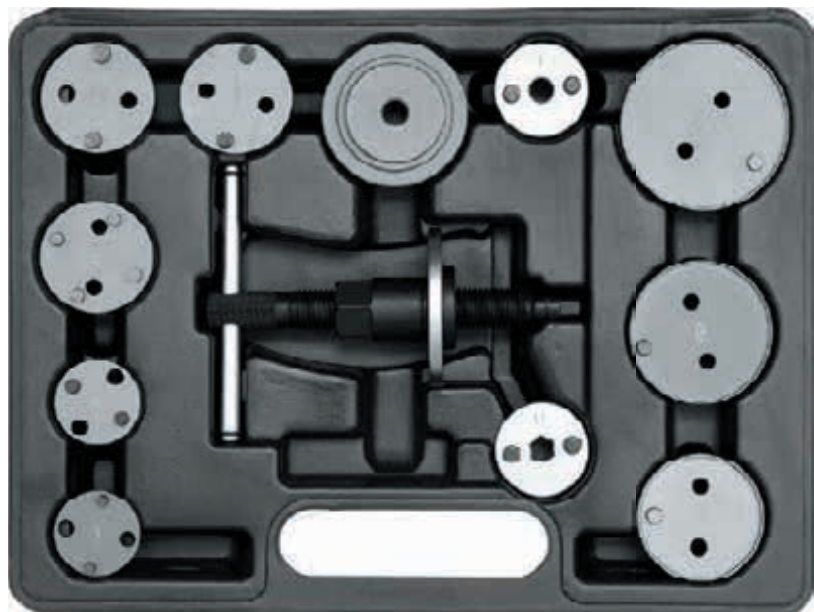

BMC
& COLOR
SLEEVE

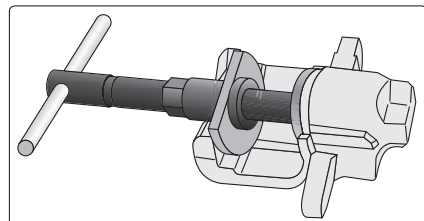

YATO 	No.	zacisk przedni (F)	zacisk tylny (R)	
YT-0611	0	General Motors - zaciski 2 1/2" (63.5 mm)		10
	1	Adapter do przedniego zacisku		
	2	Citroen XM, Xantia (F/R)		
	3		Opel (R)	
	4		Ford (R), Mazda (R), Saab (R), Alfa Romeo 164 2.0 (R), Honda (R), General Motors (R)	
	5	Nissan Maxima		
	6		Nissan Primera, VW Golf IV	
	7	Audi (F), Rover, Subaru (F), Ford (F), Nissan (F), Peugeot (F), Toyota (F), VW (F)		
	8	General Motors - zaciski 1 7/8" (47.6 mm)		
	9	General Motors - zaciski 2 1/8" (54.0 mm)		
	11		Adapter do tylnego zacisku	

- GB Disk brake pad and caliper
- D Pneumatischer Werkzeugsatz für Bremssattelsysteme
- PL Pneumatyczny zestaw do zacisków hamulcowych
- RUS Пневматический набор к тормозным зажимам
- CZ Pneumatická souprava k montáži kotoučových brzd
- H Pneumatikus készlet fék-munkahengerekhez
- RO Ansamblu pneumatic pt. cilindre de frana
- F Set pneumatique aux séparateurs de pinces de frein
- I Kit universale regolazione pneumatico per pistoni freni
- E Juego de herramientas neumaticas para apretadores de frenos
- CN 盘式制动衬块和制动钳

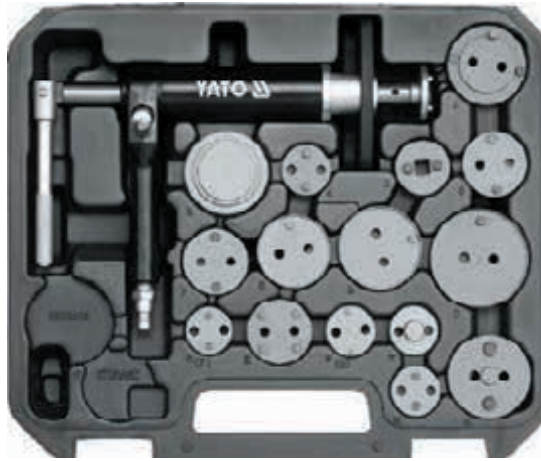
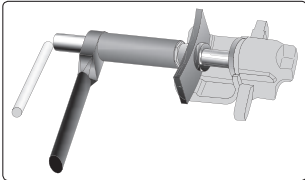

16
PCS

0.75
MPa



BMC
& COLOR
SLEEVE



YATO 	No.	zacisk przedni (F)	zacisk tylny (R)		
YT-0671	0	General Motors - zaciski 2 1/2" (F) (63.5 mm)		5	
	2		Citroen XM, Xantia (F/R)		
	3	Audi (F), Alfa Romeo (F), Fiat (F), Ford Fiesta (F), Isuzu (F), Honda Concerto (F), Jaguar (F/R), BMW (F), Mercedes-Benz (F), Mitsubishi Colt (F), Nissan: Almera, Stanza, Sunny (F), Rover (F), Toyota Camry (F), Volvo (F), VW (F)			
	4		Ford (R), Mazda (R), Saab (R), Alfa Romeo 164 2.0 (R), Honda (R), General Motors (R)		
	5		Adapter z gniazdem 3/8"		
	6				
	7		Nissan Primera (R), VW Golf IV (R)		
	8	General Motors - zaciski 1 7/8" (47.6 mm)			Audi (R), Rover, Subaru (R), Ford (R), Nissan (R), Peugeot (R), Toyota (R), VW (R)
	9	General Motors - zaciski 2 1/8" (54.0 mm)			
	A				Renault (R)
	E		Nissan Maxima (F/R)		
	F				Opel (R)
	K				Citroen (R)
	M				Ford (R), Cooper (R)
N		Saab, Honda (F/R)			

- GB Disc brake pad & caliper service tool kit
- D Werkzeugsatz von manuellen Separatoren für die Bremsklappen
- PL Zestaw ręcznych separatorów do zacisków hamulcowych
- RUS Набор ручных сепараторов для тормозных зажимов
- CZ Ruční sada na montáž kotoučových brzd
- H Fékmunkahenger prés készlet
- RO Set de separatoare manuale pt. etrier frâna
- F Set de repousse piston de frein
- I Kit universale regolazione manuale per pistoni freni
- E Juego de separadores manuales para abrazaderas de freno
- CN 刹车片分离器组套

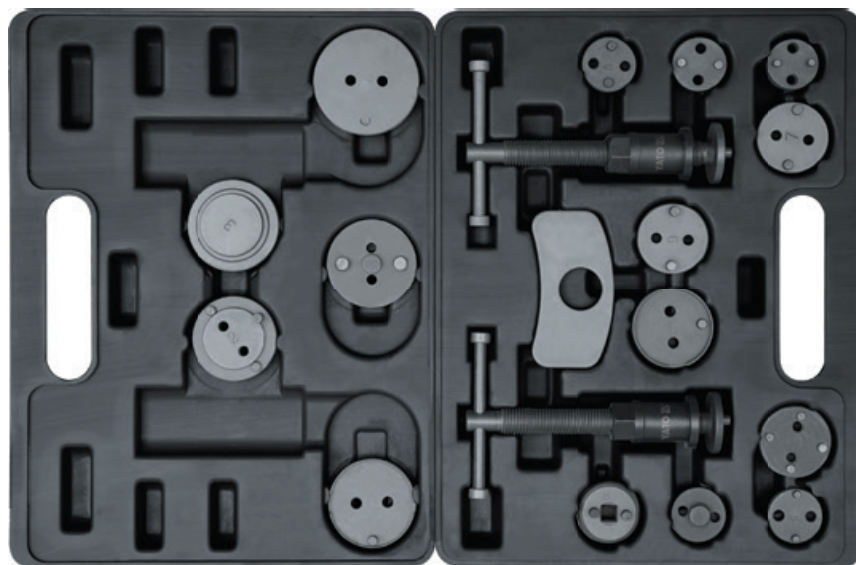
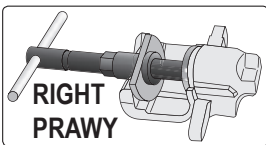
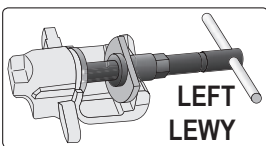

18
PCS

BMC
& COLOR
SLEEVE



16

YATO 	No.	zacisk tylny (R)	zacisk tylny (R)		
YT-0682	1-1		sitowniki z lewym i prawym gwintem	5	
	1		plytka oporowa		
	5	3/8" (10.0 mm)	adapter z gniazdem		
	0	2 1/2" (63.5 mm)	General Motors		
	2	2 1/64" (51.0 mm)			Citroen XM, Xantia
	3	2 5/32" (55.0 mm)	Audi, Alfa Romeo, Fiat, Ford Fiesta, Honda, Jaguar, BMW, Mercedes, Mitsubishi Colt, Nissan, Rover, Austin, Toyota Camry, Volvo, VW: Passat, Golf GTI		Jaguar
	4	1 1/4" (32.0 mm)			Ford, Mazda, Saab, Alfa Romeo 164, Honda, General Motors
	6	1 21/32" (42.0 mm)			Nissan Primera, VW Golf IV
	7	1 21/32" (42.0 mm)			Audi, Rover, Subaru, Ford, Nissan, Peugeot, Toyota, VW
	8	1 7/8" (48.0 mm)	General Motors		
	9	2 1/8" (54.0 mm)	General Motors, Cadillac		
	E	1 21/32" (42.0 mm)			Nissan Maxima
	F	1 1/4" (32.0 mm)			Opel
	K	2 1/8" (54.0 mm)			Citroen
M	1 1/4" (32.0 mm)		Ford		
N	1 1/4" (32.0 mm)		Saab, Honda		
A	1 3/16" (30.0 mm)		Renault		

- GB** Disc brake pad & caliper service tool kit
- D** Werkzeugsatz von manuellen Separatoren für die Bremsklappen
- PL** Zestaw ręcznych separatorów do zacisków hamulcowych
- RUS** Набор ручных сепараторов для тормозных зажимов
- CZ** Ruční sada na montáž kotoučových brzd
- H** Fékmunkahenger prés készlet
- RO** Set de separatoare manuale pt. etrier frâna
- F** Set de repousse piston de frein
- I** Kit universale regolazione manuale per pistoni freni
- E** Juego de separadores manuales para abrazaderas de freno
- CN** 刹车片分离器组套

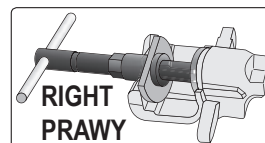
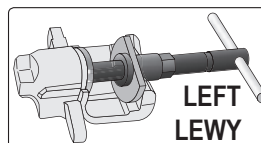

**35
PCS**
3/8"
10mm

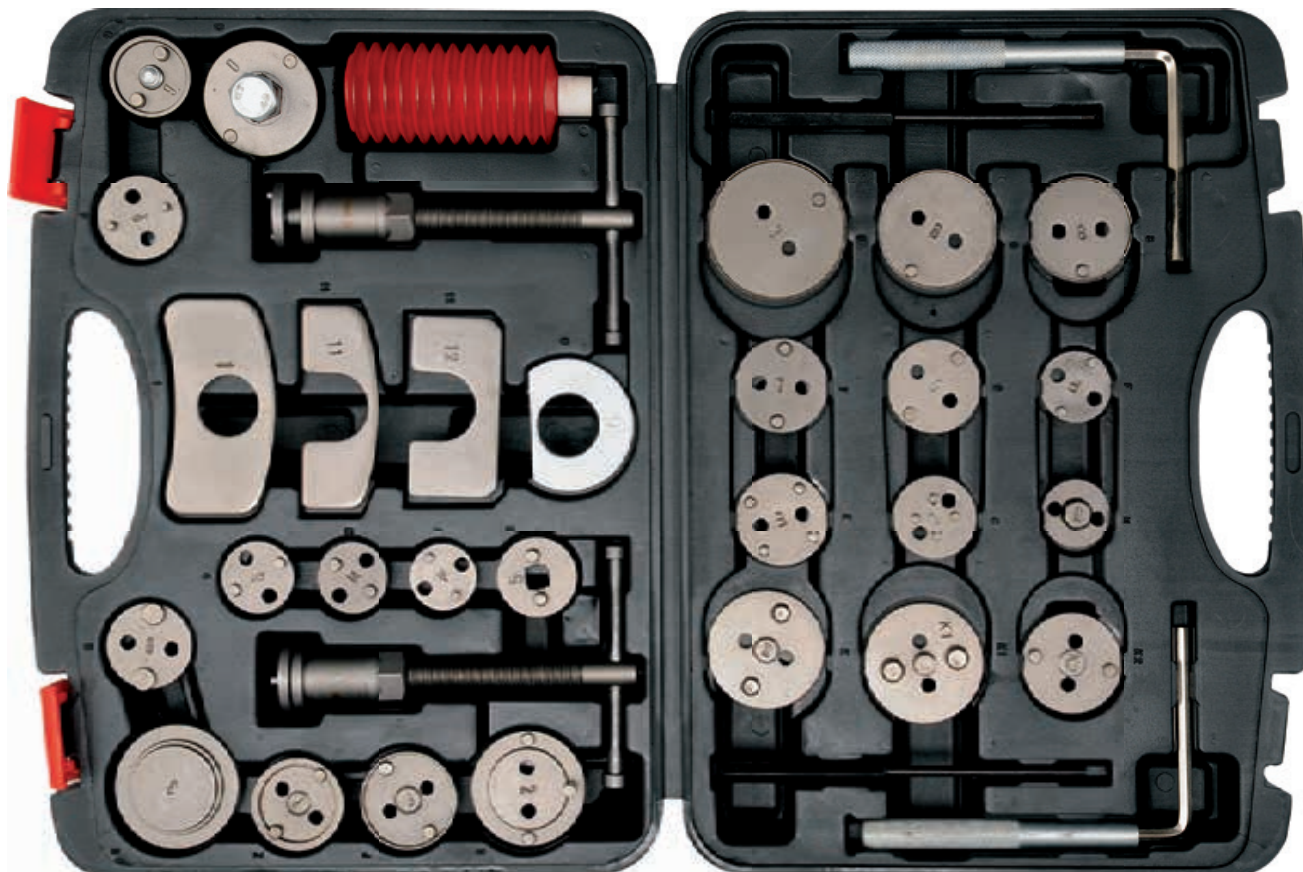

BMC
& COLOR
SLEEVE



No.	No.	zacisk przedni (F)	zacisk tylny (R)
	2	2 1/64" (51.0 mm)	Citroen Xantia, Honda Prelude
	3	2 5/32" (55.0 mm)	Fiat, Alfa Romeo, Isuzu, Mercedes Benz, BMW, Citroen, Ford, Honda, Jaguar, Nissan, Peugeot, Rover, Toyota, VAG, Volvo Jaguar
	4	1 1/4" (32.0 mm)	Ford, Mazda, Saab, Fiat, Alfa Romeo, General Motors
	5	3/8" (10.0 mm)	adapter z gniazdem
	7	1 21/32" (42.0 mm)	Nissan, VAG, Jaguar S
	6	1 21/32" (42.0 mm)	Audi, Rover, Subaru, Ford, Nissan, Peugeot, Toyota, VAG, Saab, Jaguar, GM
	8	1 7/8" (48.0 mm)	General Motors
	9	2 1/8" (54.0 mm)	General Motors, Cadillac
	0	2 1/2" (63.5 mm)	General Motors
	A	1 1/5" (30.5 mm)	Renault, BMW, Mini
YT-06822	B	1 19/30" (41.5 mm)	Ford, Lincoln, Subaru
	C	1 19/30" (41.5 mm)	Mini, Nissan, Opel, Toyota
	D	2 1/64" (51.0 mm)	Renault, Citroen
	E	1 21/32" (42.0 mm)	Nissan Maxima
	F	1 1/4" (32.0 mm)	Opel, Fiat
	G	3/8" (10.0 mm)	Peugeot, GM
	J	1 22/33" (42.5 mm)	Fiat, Alfa Romeo, Audi, Citroen, Renault, Peugeot, Ford, Nissan, Saab, VAG, Subaru, Volvo
	K	2 1/8" (54.0 mm)	Citroen, Opel
	K1	2 1/8" (54.0 mm)	Renault, Citroen
	K2	1 22/23" (50.0 mm)	Citroen, Renault, Audi
	P	1 19/30" (41.5 mm)	VAG, BMW, Ford, Lancia, Proton, Renault, Rover, Citroen
	M	1 1/4" (32.0 mm)	Ford, Mini, Nissan
	N	1 1/4" (32.0 mm)	Saab, Honda, Alfa Romeo, Ford Mondeo, Lancia, Volkswagen
	Z	1 3/16" (30.0 mm)	Ford, Mazda, Mitsubishi, Toyota Corolla
	1, 11, 12		plytka oporowa

- GB** Coil spring clamp
D Federspanner
PL Ściągacz do sprężyn
RUS Съёмник пружин
CZ Stahovák pružin tlumičů automobilů
H Rugóösszehúzó
- RO** Presa pt. arcuiri
F Compresseurs de ressort
I Estrattore per smonta molle
E Extractor de muelles
CN 弹簧夹



COLOR BOX

2
PCS
1/2" (12.5 mm)
21 mm

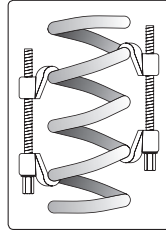

YATO	Ø (mm)	L (mm)	
YT-0605	90	200	5/10



CrV

YATO	Ø (mm)	L (mm)	
YT-2544	82	370	8

COLD FORGED KUTE NA ZIMNO

YATO	Ø (mm)	L (mm)	
YT-2546	82	280	8
YT-2547	82	355	8

- GB** Macpherson spring dumper extractor
D Abziehvorrichtung für Federn von MacPherson
PL Ściągacz do sprężyn MacPhersona
RUS Съёмник пружин подвески Макферсона
CZ Stahovák pružin McPherson
H MacPerson rugó összehúzó
RO Extractor de arcuiri MacPherson
F Compresseurs de ressort MacPherson
I Estrattore per molle MacPherson
E Desmontador para los resortes de MacPherson
CN 弹簧压缩器

CrMo SCM-415

3
POINTS OF FIXING
PUNKTY MOCOWANIA

max. 2900kg

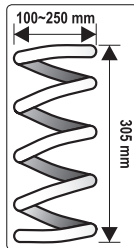

WHITE CARTON BOX & COLOR LABEL



YATO		
YT-2535		2

- GB** Vice for shock absorber
D Halterung, Schraubstock für die Säule von MacPherson
PL Uchwyt, imadło do kolumny MacPhersona
RUS Тиски к подвеске Макферсона
CZ Upinací přípravek, svěrák na nápravy McPherson
H Fogantyú, satu MacPerson oszlophoz
RO Mâner, menghină pt. coloana MacPherson
F Poignée et étau pour la colonne MacPherson
I Manico e vice colonna MacPherson
E Mandril, torno para la columna de MacPherson
CN 弹簧减震器固定器

35~70 mm



WHITE CARTON BOX & COLOR LABEL



YATO		
YT-2537		5

- GB** Interchangeable fork spring compressor and removal tool
D Abziehvorrichtung für MacPherson-Federn mit austauschbaren Halterungen
PL Ściągacz do sprężyn MacPhersona z wymiennymi uchwytami
RUS Стяжка для снятия пружин Макферсона со сменными полукольцами
CZ Stahovák pružin McPherson s výměnitelnými čelistmi
H MacPerson rugó összehúzó cserélhető pófakkal
RO Ancoră suspensie MacPherson cu mâner interschimbabile
F Compresseurs de ressort MacPherson
I Smonta ammortizzatori per sospensioni MacPherson
E Extractor de resortes MacPherson con mangos intercambiables
CN 免拆式减震弹簧压缩器

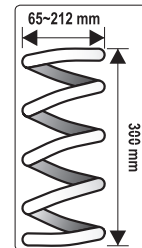

7
PCS

65-125 mm

88-160 mm

max. 1500kg

126-212 mm

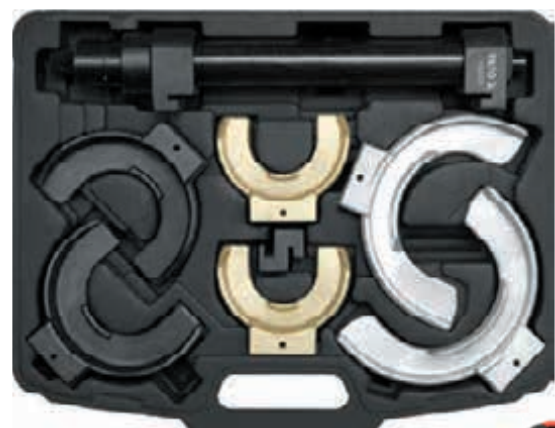

BMC & COLOR SLEEVE



YATO		
YT-2536		1

- GB** Drive nut set
- D** Stossdämpfer Nutmutter Einsätze
- PL** Zestaw nasadek do amortyzatorów
- RUS** Набор головок для амортизаторов
- CZ** Sada hlavic na uložení tlumiče
- H** Lengéscsillapítókiszedő szet
- RO** Set prezoane
- F** Set des embouts aux amortisseurs
- I** Set di chiavi per aria condizionata
- E** Juego de boquillas de amortiguadores
- CN** 拆装减震器套件组套

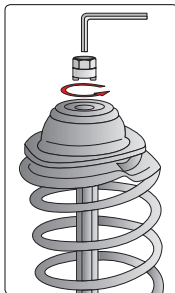

5
PCS

- No. 1 10.5 mm VW Golf rear
- No. 2 12.5 mm VW Golf front
- No. 3 14.5 mm VW Polo, Golf, Passat, Audi 80
- No. 4 14.5 mm Austin Maestro
- No. 5 14.0 mm Mercedes Benz C-Class (W203)

SLIDING
CARD

YATO	size / rozmiar (mm)	
YT-0621	10.5; 12.5; 14.5; 14.5; 14.0	12/48

- GB** Turnbuckle for shock absorber's top lid
- D** Schlüsselsatz zum Befestigen der Stoßdämpfer
- PL** Zestaw kluczy do mocowania amortyzatorów
- RUS** Набор ключей для крепления амортизаторов
- CZ** Sada klíčů k montáži tlumičů
- H** Kulcskészlet lengéscsillapítók rögzítéséhez

- RO** Set chei pt. fixare amortizoare
- F** Set de clés pour amortisseurs
- I** Set chiavi per montare ammortizzatori
- E** Juego de llaves para la instalación de amortiguadores
- CN** 避震器拆卸器

39 PCS	CrMo SCM415	CrV 6140	CrV 50BV30	STEEL 8660
------------------	-----------------------	--------------------	----------------------	-----------------------------

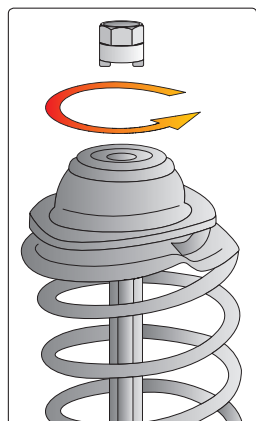

BMC
& COLOR
SLEEVE

YATO	size / rozmiar (mm)	type of car / model samochodu	size / rozmiar (mm)	type of car / model samochodu
YT-0628	10.5 x 3.5	VW Golf Rear Axle	D5	Nissan
	12.5 x 3.5	VW Golf Front Axle	D10	Nissan, Ford
	14.5 x 5	VW Polo, Golf, Passat, Audi 80	8	Mercedes-Benz
	14.5 x 3	Austin Maestro	9	Opel/Vauxhall, Chrysler
	14 x 2.5	Mercedenz Benz W203 (C-class), W209 (CLK)	10	Chrysler, Ford
	14	Honda, Nissan	11	Japanese Cars
	16	VW, Audi, Seat, Fiat	5	Honda
	17	Ford, VW, Audi, Seat, Fiat	6	Seat, Fiat, Citroen, Peugeot, Ford, Opel, Renault, Japanese Cars, BMW
	18	Ford, VW, Audi, Seat, Rover, Fiat, Opel, Peugeot, Renault, Japanese Cars	7	VW, Audi, Seat, Fiat, Citroen, Peugeot, Mercedes-Benz (W203), Renault
	19	VW, Audi, Seat, Citroen, Fiat, Opel, Peugeot, Toyota	8	Mercedes-Benz
	21	Mercedenz-Benz W203, Chrysler, VW, Audi, Ford, Japanese Cars	3	Mercedes-Benz, Opel, Renault
	22	VW, Audi, Seat, Citroen, Fiat, Opel, Peugeot, Renault, BMW	3.5	Chrysler, Ford, Citroen, Peugeot
24	Volvo	4	Citroen, Peugeot	
27	VW, Audi, Citroen, Peugeot	M12	Opel/Vauxhall	
4	Nissan	T50	Nissan, Ford	
5.2	VW, Audi, Nissan	T60	Ford	
6	VW, Audi, Renault			
6.3	Nissan			
7	VW, Audi, Seat, Fiat			
8	Seat, Fiat			
9	Japanese Cars			
10	Seat, Fiat, Volvo			
12	Seat, Fiat			

- GB** Tire valve stem inserter
- D** Abziehvorrichtung für die Gummiventile
- PL** Przeciagacz do zaworków gumowych
- RUS** Протяжка к резиновым клапанам

- CZ** Páka k provlékání bezdušových ventilů
- H** Szijfeszesség mérő
- RO** Broșă pt. supapele cauciucate
- F** Levier tire-valve

- I** Brocca valvola di gomma
- E** Brocha de tracción para las válvulas de goma
- CN** 气门插入工具

SLIDING
CARD

290
mm

RUBBER
VALVES
ZAWORKY
GUMOWE



YATO	L (mm)	
YT-0619	290	12/72

- GB** Wheel balance pliers
D Auswuchtgewicht-Zange
PL Szczypce do wyważania kół
RUS Клещи для балансировки колес
CZ Kleště pro vyvažování kol
H Centírsúly szerelő szerszám
RO Cleste pt. cauciuc
- F** Pincés pour le contrepois à agrafe de roue de voiture
I Pinze per equilibrio ruota
E Tenazas de equilibrar ruedas
CN 平衡钳

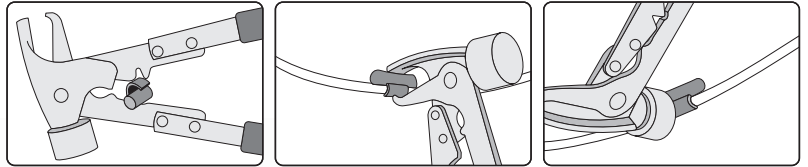

SLIDING CARD

YATO		
YT-0643		12/48

- GB** Deep thin wall impact sockets
D Schon-Kraftschraubereinsatz für Alufelgen
PL Zestaw nasadek uderowych do felg aluminiowych
RUS Набор головок для алюминиевых дисков
CZ Sada nástrčných klíčů na alu ráky
H Hosszított dugókulcs készlet, könnyűfém felnikhez
RO Dibli de impact cu mufare in interior
F Set de douilles profondes à choc
I Set di chiavi a bussola per dadi ruota di alluminio
E Juego de boquillas de percusión para llantas de aluminio
CN 风动薄壁长套筒



3 PCS	1/2" 12.5mm	17 19 21 mm
CrMo SCM-440	26 29 31 mm	AS-DRIVE



BMC & COLOR BOX

- for service station and tire workshops
 - for maximum impact loads
 - drive locks
 - ultra thin walls and nylon cover for working with alu rims
 - anodised colour finish for fast identification of size
- dla serwisów i warsztatów oponiarskich
 - do największych obciążeń uderowych i tętniących
 - zamki blokujące
 - ultra cienkie ścianki i nylonowe pokrycie do pracy z felgami aluminiowymi
 - anodowane kolorowe wykończenie dla szybkiej identyfikacji rozmiaru

YATO	Ø	
YT-1056	1/2" (12.7 mm)	12/24

- GB** Rubber valve core torque tool
D Drehmomentwerkzeug für gummi Dichtende Reifenventileinsätze
PL Klucz dynamometryczny do zaworków gumowych
RUS Ключ динамометрический для резиновых клапанов
CZ Klíč momentový k montáži gumových ventilků
H Szeleptűkiszerező kulcs gumitömítésű szelephez
RO Surubelnita din plastic pt. supapa
F Clé dynamométrique pour soupapes
I Giravite dinamometrica per valvole
E Llave dinamométrica de válvulas de goma
CN 定扭橡胶气门芯拆卸工具

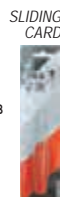

SLIDING CARD
0.25
Nm
RUBBER VALVES ZAWORY GUMOWE

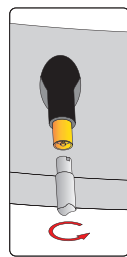

YATO		
YT-0795		50/200

- GB** Metal valve core torque tool
D Drehmomentwerkzeug für metallisch Dichtende Reifenventileinsätze
PL Klucz dynamometryczny do zaworków metalowych
RUS Ключ динамометрический для металлических клапанов
CZ Klíč momentový k montáži kovových ventilků
H Szeleptűkiszerező kulcs fémtömítésű szelephez
RO Surubelnita metalica pt. supapa
F Clé dynamométrique pour soupapes
I Giravite dinamometrica per valvole
E Llave dinamométrica de válvulas de metal
CN 定扭橡胶气门芯拆卸工具



SLIDING CARD
0.45
Nm
METAL VALVES ZAWORY METALOWE

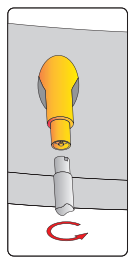

YATO		
YT-0796		50/200

- GB** Cross rim wrench
D Kreuzschlüssel
PL Krzyżakowy klucz do kół
RUS Ключ-крест балонный
CZ Klíč na kola křížový
H Kereszt kerékkulcs
RO Cheie în cruce pt. roți
F Clé en croix aux roues
I Chiavi a croce per auto ruota
E Llave cruz para ruedas
CN 十字套筒扳手



CrV



PLASTIC HANGER

YATO	size / rozmiar	
YT-0800	17 x 19 x 21 x 22 mm	10
YT-0801	17 x 19 x 21 x 1/2" (12.7 mm)	10
YT-0802	24 x 27 x 32 x 3/4" (19.0 mm)	3

- GB** T-type sleeved ratchet wrench
D Radmutter Schlüssel für Autos
PL Klucz do kół samochodowych
RUS Ключ к автомобильным колесам
CZ Klíč na kola automobilů
H Kerékkulcs
RO Cheie pt. roți de automobile
- F** Clé cliquet aux roues
I Chiavi per ruota auto
E Llave para las ruedas de automóviles
CN T型棘轮扳手组套

PLASTIC HANGER



- 4** PCS
1/2"
12.5mm
44T
CrV
50BV30
AS-DRIVE



1/2" (12.7 mm): 17, 19, 21, 23 mm

YATO		
YT-0803		5/10

- GB** Folding cross wrench
D Radmutter Schlüssel
PL Składany klucz do kół w etui
RUS Балонный крестовой разборный ключ с чехлом
CZ Skládací křížový klíč na matice
H Összecsukható kereszt csavarkulcs

- RO** Cheie cruce pt. șuruburi roți
F Clé démonte roue en croix démontable
I Pierevole cress chiave
E llave para las ruedas de automóviles
CN 快速十字扳手

TEXTILE WALLET & COLOR BOX

- 4** PCS
17 mm
19 mm
21 mm
23 mm
1/2"
12.5mm
CrV
WALLET ETUI

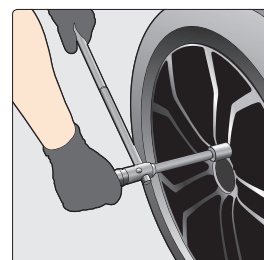

YATO	size / rozmiar	
YT-08035	1/2" (12.7 mm)	10

- GB** Wrecking bar
D Reifenmontierhebel
PL Łyżka do opon
RUS Прибор для шиномонтажа
CZ Montážní páka na pneumatiky

- H** Gumiabroncs kar
RO Levier pt. roti
F Cuillère à pneus
I Leva per pneumatici

- E** Desmontable para las llantas
CN 轮胎起子

- 300 mm**
400 mm
500 mm
600 mm
CrV



YATO	size / rozmiar (mm)	
YT-0807	300	20
YT-0808	400	20
YT-0809	500	5/20
YT-0810	600	5/20

- GB** Tire level
D Reifenmontierhebel
PL Łyżka do opon
RUS Прибор для шиномонтажа

- CZ** Montážní páka na pneumatiky
H Gumiabroncs kar
RO Levier pt. roti
F Cuillère à pneus

- I** Leva per pneumatici
E Desmontable para las llantas
CN 撬棒

SLIDING CARD

- 380 mm**
CrMo



YATO	size / rozmiar (mm)	
YT-0811	380	10/50

- GB** Rectangular telescopic inspection mirror
D Teleskop Inspektionsspiegel
PL Lusterko inspekcyjne

- RUS** Зеркало инспекционное телескопическое
CZ Zrcátko kontrolní teleskopické
H Vizsgáló tükör, teleszkópos nyéllel

- RO** Oglindă telescopica pt. inspectie
F Miroir d'inspection
I Telescopio ispezione specchietto

- E** Espejo rectangular telescópico de inspección
CN 可伸缩矩形检测镜

- 50x90 mm**
TELESCOPIC HANDLE 285x770 mm



YATO		
YT-0660		12/144

- GB** LED lighted telescopic inspection mirror
D Prüf Spiegel mit Beleuchtung
PL Lusterko inspekcyjne z lampką

- RUS** Зеркало досмотровое с подсветкой
CZ Inspekční zrcadélko s lampou
H Vizsgáló tükör, lámpával

- RO** Oglindă pt. inspectie cu lampă
F Miroir d'inspection avec lampe
I Specchio di ispezione con lampada

- E** Espejo de control con lámpara
CN 带灯检测镜

265 - 920 mm, Ø54 mm TELESCOPIC HANDLE TELESKOPOVÝ UCHVÝT

LED

STAINLESS STEEL NERZEVNA



YATO		
YT-0663		10/100

GB Telescopic magnetic pick up tool
D Teleskop magnet Heber
PL Chwytek teleskopowy z magnesem
RUS Захват магнитный телескопический

CZ Patka teleskopická magnetická
H Felszedő mágnes, teleszkópos nyéllel
RO Telescop magnetic
F Capteur magnétique

I Telescopio magnete
E Herramienta levantadora magnética, telescópica
CN 可伸缩磁性拾拾器

2 kg
MAGNETIC
TELESCOPIC HANDLE 250x750 mm



YATO
YT-0661 12/144

GB Telescopic magnetic pick up tool
D Teleskop magnet Heber
PL Chwytek teleskopowy z magnesem
RUS Захват магнитный телескопический

CZ Patka teleskopická magnetická
H Felszedő mágnes, teleszkópos nyéllel
RO Telescop magnetic
F Capteur magnétique avec une diode

I Telescopio magnete
E Herramienta levantadora magnética, telescópica
CN 可伸缩磁性拾拾器

MAGNETIC
190-300mm TELESCOPIC HANDLE
TELESKOPOWY UCHWYT
LED



YATO
YT-0661 12/144

GB Telescopic magnetic pick up tool
D Teleskop magnet Heber
PL Chwytek teleskopowy z magnesem
RUS Захват магнитный телескопический
CZ Patka teleskopická magnetická
H Felszedő mágnes, teleszkópos nyéllel
RO Telescop magnetic
F Capteur magnétique télescopique
I Telescopio a specchio
E Herramienta levantadora magnética, telescópica
CN 可伸缩磁性拾拾器

22.5 kg
82 mm
TELESCOPIC HANDLE UCHWYT TELESKOPOWY 59-99 cm



YATO
YT-0860 L (mm) 6/24

GB Telescopic pick up and mirror set
D Inspektionssatz: Spiegel + Greifer
PL Zestaw inspekcyjny: lusterko + chwytek
RUS Проверочный набор + держатель и зеркальце
CZ Inspekční souprava: zrcadlo + držák
H Teleszkópos ellenőrző készlet
RO Garnitură de control: oglindă + benă
F Kit miroir + grappin
I Set per ispezione: specchio + supporto
E Juego de inspección: espejo + cuchara de mordazas
CN 检测镜拾拾器组套

PLASTIC BOX & DOUBLE BLISTER



4 PCS
0.5 kg (max)
1.5 kg (max)
160-620 mm TELESCOPIC HANDLE UCHWYT TELESKOPOWY
250-930 mm, Ø 57 mm TELESCOPIC HANDLE UCHWYT TELESKOPOWY
MAGNETIC



YATO
YT-0662 10/40

GB Magnetic parts tray
D Magnetschale
PL Miska magnetyczna
RUS Магнитный поднос
CZ Miska magnetická
H Mágneses tálca

RO Tava magnetica
F Bol magnétique
I Ciotola magnetica

E Bandeja de accesorios magnética
CN 磁盘

COLOR BOX



MAGNETIC



Ø mm 110

YATO
YT-08295 12/48



Ø mm 150

YATO
YT-0830 12/48

GB Magnetic parts tray
D Magnetschale
PL Miska magnetyczna
RUS Магнитный поднос
CZ Miska magnetická
H Mágneses tálca
RO Tava magnetica
F Bol magnétique
I Ciotola magnetica
E Bandeja de accesorios magnética
CN 磁盘

0,10-0,12 T (TESLA)
Ø mm 150
MAGNETIC



YATO
YT-08305 20

COLOR BOX



GB Magnetic parts tray
D Magnetschale
PL Miska magnetyczna
RUS Магнитный поднос
CZ Miska magnetická
H Mágneses tálca
RO Tava magnetica
F Bol magnétique
I Ciotola magnetica
E Bandeja de accesorios magnética
CN 磁盘

COLOR BOX



350x150 mm
MAGNETIC



YATO
YT-0831 6/12

- GB** Magnetic tool holder
D Magnet Werkzeughalter
PL Listwa magnetyczna
RUS Магнитная рейка
CZ Magnetický držák nářadí
- H** Mágneses tartó
RO Suport magnetic
F Barre et porte
 outil magnétique
I Striscia magnetica

- E** Bandeja de accesorios
 magnética
CN 磁性工具架



YATO	
YT-0835	4/16

- GB** Magnetic holder for tools
D Magnethalter für Schlagschrauber
PL Uchwyt magnetyczny na narzędzia
RUS Магнитный держатель
 для ударного гайковерта
CZ Magnetický držák nářadí
H Mágneses tartó
RO Suport magnetic pt. scule pneumatice
F Support magnétique
 pour outils pneumatiques
I Fissaggio magnetico per chiave
 ad impulsi pneumatica
E Soporte magnético
 para llave de impacto
CN 磁性喷枪架



COLOR BOX



YATO	
YT-08707	5/10

- GB** Tweezer
D Pinzette
PL Pęseta
RUS Пинцет
- CZ** Pinzeta
H Csipesz
RO Pensetă
F Pince
- I** Pinza
E Pinzas
CN 镊子

SLIDING CARD



YATO	L (mm)	
YT-6903	140	20/480

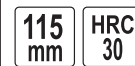

YATO	L (mm)	
YT-6907	115	20/240

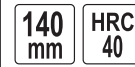

YATO	L (mm)	
YT-6916	140	20/240

- GB** Workshop creeper
D Werkstatt-Liege
PL Leżanka warsztatowa
RUS Лежак ремонтный
CZ Lehátko
H Fekpad gurulos
RO Targa
F Chariot de visite
I Lettino sdraio
 sotto vettura
E Camilla de taller
CN 汽修躺板



WHITE
 CARTON BOX
 & COLOR LABEL



YATO	
YT-0880	1



YATO	
YT-08802	1

COLOR BOX



- | | |
|--|--|
| GB LED rechargeable floodlight | RO Reflector cu led |
| D Akku-Diodenscheinwerfer | F Projecteur a LED rechargeable |
| PL Reflektor diodowy akumulatorowy | I Lampada a LED a batteria |
| RUS Светодиодный аккумуляторный прожектор | E LED reflector rechargeable |
| CZ LED reflektor dobijeci | CN 工作灯 |
| H LED reflektor újratölthető | |



10W	3.7V 4400mAh Li-Ion!	800 lm	6000 K
Micro USB	4400mAh	WORK TIME CZAS PRACY 2.5 h	CHARGING TIME CZAS ŁADOWANIA 5.5 h

COB
LED



YATO	
YT-81820	6/12

- | | |
|-----------------------------------|------------------------------|
| GB LED lamp | RO Reflector diodă |
| D Diodenscheinwerfer | F Projecteur LED |
| PL Reflektor diodowy | I Faretto LED |
| RUS Светодиодный прожектор | E Reflector de diodos |
| CZ LED reflektor | CN 工作灯 |
| H Diódás reflektor | |



80W	6000 lm	6000 K	230V~ 50Hz
	20000 h	IP65	

COB
LED



WHITE CARTON BOX & COLOR LABEL

YATO	
YT-81812	3

- | |
|---|
| GB Workshop LED battery lamp |
| D LED Akku-handleuchte |
| PL Diodowa lampa warsztatowa akumulatorowa |
| RUS Светодиодная беспроводная лампа |
| CZ Ruční svítidla LED |
| H LED szerelő lámpák |
| RO Lampa portabila cu acumulator leduri |
| F Lampe a LED rechargeable |
| I Lampada LED per officina |
| E Linterna LED rechargeable |
| CN 可充裝針腳 |



CRI 95	5W	3.7V 2600mAh Li-Ion!	400 lm
4500K	CHARGING TIME CZAS ŁADOWANIA 4h	WORK TIME CZAS PRACY 4h	
IP65	IK07		2x

COB
LED





HANGING
COLOR BOX



YATO	
YT-08509	12



- GB Workshop LED battery lamp
- D LED Akku-handleuchte
- PL Diodowa lampa warsztatowa akumulatorowa
- RUS Светодиодная беспроводная лампа
- CZ Ruční svítlna LED
- H LED szerelő lámpák
- RO Lampa portabila cu acumulator leduri
- F Lampe a LED rechargeable
- I Lampada LED per officina
- E Linterna LED recargable
- CN 可充裝款釘腑

 FRONT LIGHTING FUNKCIA LATAJARI	1+1 LED	3.7V 3600mAh Li-Ion	180 lm
 230V~50Hz BATTERY CHARGER LADOWARKA	12V BATTERY CHARGER LADOWARKA	4h CHARGING TIME CZAS LADOWANIA	3h 3h 2 LED WORK TIME CZAS PRACY
 HOOK HAK	 MAGNETIC		







COB
LED



YATO
YT-08502 10

- GB Workshop LED battery lamp
- D LED Akku-handleuchte
- PL Diodowa lampa warsztatowa akumulatorowa
- RUS Светодиодная беспроводная лампа
- CZ Ruční svítlna LED
- H LED szerelő lámpák
- RO Lampa portabila cu acumulator leduri
- F Lampe a LED rechargeable
- I Lampada LED per officina
- E Linterna LED recargable
- CN 可充裝款釘腑

 FRONT LIGHTING FUNKCIA LATAJARI	5+3 W	3.7V 2600mAh Li-Ion	4h CHARGING TIME CZAS LADOWANIA
600/260 lm	6500 K	 USB BATTERY CHARGER LADOWARKA	2.5/5.5 h WORK TIME CZAS PRACY
		 MAGNETIC	 POLYCARBONATE DIFFUSER KUSZ Z POLIMESLANU

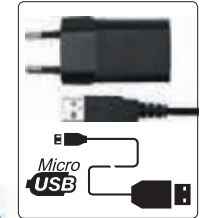
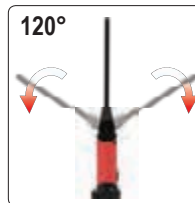





COB
LED

COLOR
BOX



YATO
YT-08518 12

- GB Workshop LED battery lamp
- D LED Akku-handleuchte
- PL Diodowa lampa warsztatowa akumulatorowa
- RUS Светодиодная беспроводная лампа
- CZ Ruční svítlna LED
- H LED szerelő lámpák
- RO Lampa portabila cu acumulator leduri
- F Lampe a LED rechargeable
- I Lampada LED per officina
- E Linterna LED recargable
- CN 可充裝款釘腑

3W	3.7V 2200mAh Li-Ion
250 lm	6000 K
 230V~50Hz BATTERY CHARGER LADOWARKA	5h CHARGING TIME CZAS LADOWANIA
IP54	3.5 h WORK TIME CZAS PRACY
IK07	 HOOK HAK
 POLYCARBONATE DIFFUSER KUSZ Z POLIMESLANU	 MAGNETIC

COB
LED



YATO
YT-08563 10



- GB Workshop LED battery lamp
- D LED Akku-handleuchte
- PL Diodowa lampa warsztatowa akumulatorowa
- RUS Светодиодная беспроводная лампа
- CZ Ruční svítlna LED
- H LED szerelő lámpák
- RO Lampa portabila cu acumulator leduri
- F Lampe a LED rechargeable
- I Lampada LED per officina
- E Linterna LED recargable
- CN 可充裝款釘腑

 FRONT LIGHTING FUNKCIA LATAJARI	3.5+3 W	3.7V 2200mAh Li-Ion	4h CHARGING TIME CZAS LADOWANIA
280 lm	6000 K	 USB BATTERY CHARGER LADOWARKA	4h WORK TIME CZAS PRACY
IP54	3.5 h WORK TIME CZAS PRACY	 x2 HOOK HAK	 x3
IK07	 POLYCARBONATE DIFFUSER KUSZ Z POLIMESLANU		

SMD
LED

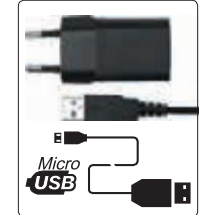

YATO
YT-08508 12

GB Workshop LED battery lamp
D LED Akku-handleuchte
PL Diodowa lampa warsztatowa akumulatorowa
RUS Светодиодная беспроводная лампа
CZ Ruční svítlna LED
H LED szerelő lámpák
RO Lampa portabila cu acumulator leduri
F Lampe a LED rechargeable
I Lampada LED per officina
E Linterna LED recargable
CN 可充長款鈎燈

FRONT LIGHTING
FUNKCJA LATARNI

30+7 LED

140 lm

3.7V 2000mAh Li-Ion

USB BATTERY CHARGER
ŁADOWNIKA

WORK TIME
CZAS PRACY
4h

CHARGING TIME
CZAS ŁADOWANIA
4h

HOOK HAK
x2

POLYCARBONATE DIFFUSER
KŁOSZ Z PC MIEGLANU

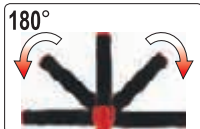

HANGING COLOR BOX

YATO
YT-08507 12

GB Workshop LED battery lamp
D LED Akku-handleuchte
PL Diodowa lampa warsztatowa akumulatorowa
RUS Светодиодная беспроводная лампа
CZ Ruční svítlna LED
H LED szerelő lámpák
RO Lampa portabila cu acumulator leduri
F Lampe a LED rechargeable
I Lampada LED per officina
E Linterna LED recargable
CN 可充長款鈎燈

FRONT LIGHTING
FUNKCJA LATARNI

1+7 LED

250 lm

3.7V 1800mAh Li-Ion

USB BATTERY CHARGER
ŁADOWNIKA

CHARGING TIME
CZAS ŁADOWANIA
4h

WORK TIME
CZAS PRACY
4h

HOOK HAK
x2

POLYCARBONATE DIFFUSER
KŁOSZ Z PC MIEGLANU



COB
LED



COLOR BOX



YATO
YT-08504 10

GB Workshop LED battery lamp
D LED Akku-handleuchte
PL Diodowa lampa warsztatowa akumulatorowa
RUS Светодиодная беспроводная лампа
CZ Ruční svítlna LED
H LED szerelő lámpák
RO Lampa portabila cu acumulator leduri
F Lampe a LED rechargeable
I Lampada LED per officina
E Linterna LED recargable
CN 可充長款鈎燈

FRONT LIGHTING
FUNKCJA LATARNI

30+7 LED

85 lm

3.7V 1800mAh Li-Ion

12V BATTERY CHARGER
ŁADOWNIKA

230V~50Hz BATTERY CHARGER
ŁADOWNIKA

CHARGING TIME
CZAS ŁADOWANIA
4-5 h

WORK TIME
CZAS PRACY
15h 7LED

WORK TIME
CZAS PRACY
4h 30LED

HOOK HAK
x2

MAGNETIC
x2



COLOR BOX



YATO
YT-08505 10

GB LED workshop lamp
D LED Werkstattlampe
PL Diodowa lampa warsztatowa
RUS Светодиодная беспроводная лампа
CZ Montážní lampa
H LED lámpa
RO Lampa cu LED
F Lampe d'atelier a LED
I Lampada LED per officina
E Lámpara de taller LED
CN 可充長款鈎燈

FRONT LIGHTING
FUNKCJA LATARNI

27 LED

13000 MCD

3.6V 1200mAh Ni-MH

12V BATTERY CHARGER
ŁADOWNIKA

230V~50Hz BATTERY CHARGER
ŁADOWNIKA

CHARGING TIME
CZAS ŁADOWANIA
4h

WORK TIME
CZAS PRACY
4h

HOOK HAK
x2

MAGNETIC
x2



DOUBLE BLISTER



YATO
YT-08523 10

GB LED workshop lamp
 D LED Werkstattlampe
 PL Diodowa lampa warsztatowa
 RUS Светодиодная беспроводная лампа
 CZ Montážní lampa
 H LED szerelő lámpák
 RO Lampa cu LED
 F Lampe d'atelier a LED
 I Lampada LED per autofficina
 E Lámpara de taller LED
 CN 可充長款鉗腳



60+1 LED	13000 MCD	7.2V 800mAh NI-MH	230V~50Hz BATTERY CHARGER LADOWARKA
WORK TIME CZAS PRACY 4h	CHARGING TIME CZAS ŁADOWANIA 4h	WATER PROOF ODPORNIA NA WODĘ	
12V BATTERY CHARGER LADOWARKA	HOOK HAK	MAGNETIC	

LED

DOUBLE BLISTER



YATO
YT-0852 5/20

GB LED workshop lamp
 D LED Werkstattlampe
 PL Diodowa lampa warsztatowa
 RUS Светодиодная беспроводная лампа
 CZ Montážní lampa
 H LED szerelő lámpák
 RO Lampa cu LED
 F Lampe d'atelier a LED
 I Lampada LED per autofficina
 E Lámpara de taller LED
 CN 可充長款鉗腳



8+1 LED	280 lm	3 LIGHTING OPTIONS OPCJE ŚWIETLENIA FRONT LIGHTING FUNKCJA LATARNI	
WORK TIME CZAS PRACY 4 h 9 LED	1.5V 3x AA	HOOK HAK	MAGNETIC

SMD LED



COLOR BOX



YATO
YT-08513 50

GB LED workshop lamp
 D LED Werkstattlampe
 PL Diodowa lampa warsztatowa
 RUS Светодиодный светильник для мастерской
 CZ Montážní lampa
 H LED szerelő lámpák
 RO Lampa cu LED
 F Lampe d'atelier a LED
 I Lampada LED per autofficina
 E Lámpara de taller LED
 CN 可充長款鉗腳



8 LED	80 lm	1.5V 3x AAA	WORK TIME CZAS PRACY 20 h 8 LED
-----------------	-----------------	--------------------------	---

SMD LED

SLIDING CARD



YATO
YT-08514 12/72

GB LED workshop lamp
 D LED Werkstattlampe
 PL Diodowa lampa warsztatowa
 RUS Светодиодная лампа
 CZ Montážní lampa
 H LED szerelő lámpák
 RO Lampa cu LED
 F Lampe d'atelier a LED
 I Lampada LED per autofficina
 E Lámpara de taller LED
 CN 可充長款鉗腳



4 LED	400 lm	IP65	CABLE H05RN-F KABEL
230V~50Hz	HOOK HAK	4.9m	

POWER LED

COLOR BOX



YATO
YT-08531 10

GB Workshop LED battery lamp
D LED Akku-handleuchte
PL Diodowa lampa warsztatowa akumulatorowa
RUS Светодиодная лампа LED

CZ Ruční svítilna LED
H LED szerelő lámpák
RO Lampa portabila cu acumulator leduri
F Lampe a LED rechargeable

I Lampada LED trasportabile per illuminazione di vani motore
E Linterna LED recargable
CN 引擎盖检修灯

SMD



100 LED	600 lm	7.4V 2000mAh Li-Ion	230V~50Hz BATTERY CHARGER LADÓVÁRKA
CHARGING TIME CZAS LADOWANIA 3-4 h	WORK TIME CZAS PRACY 4 h 100 LED	HOOK HAK	MAGNETIC



YATO	8
YT-08503	

GB Workshop LED battery lamp
D LED Akku-handleuchte
PL Diodowa lampa warsztatowa akumulatorowa
RUS Светодиодная лампа LED

CZ Ruční svítilna LED
H LED szerelő lámpák
RO Lampa portabila cu acumulator leduri
F Lampe a LED rechargeable

I Lampada LED trasportabile per illuminazione di vani motore
E Linterna LED recargable
CN 引擎盖检修灯



120 LED

350 lm	60 LED	120 LED	7.2V 1800mAh Ni-MH	230V~50Hz BATTERY CHARGER LADÓVÁRKA
WORK TIME CZAS PRACY 8 h 60 LED	WORK TIME CZAS PRACY 4 h 120 LED	CHARGING TIME CZAS LADOWANIA 4-5 h	HOOK HAK	MAGNETIC

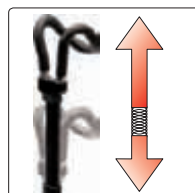
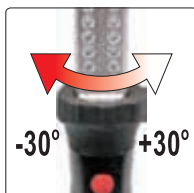

YATO	4
YT-08530	

GB Workshop LED battery lamp
D LED Akku-handleuchte
PL Diodowa lampa warsztatowa akumulatorowa
RUS Светодиодная лампа LED

CZ Ruční svítilna LED
H LED szerelő lámpák
RO Lampa portabila cu acumulator leduri
F Lampe a LED rechargeable

I Lampada LED trasportabile per illuminazione di vani motore
E Linterna LED recargable
CN 引擎盖检修灯

SMD



36 LED	18 LED	36 LED	7.4V 2400mAh Li-Ion	230V~50Hz BATTERY CHARGER LADÓVÁRKA
900 lm	CHARGING TIME CZAS LADOWANIA 5.5 h	WORK TIME CZAS PRACY 3.5 h	HOOK HAK	MAGNETIC

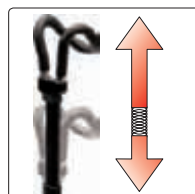
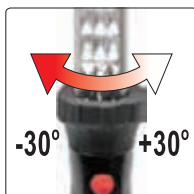

YATO	4
YT-08533	

GB Workshop LED battery lamp
D LED Akku-handleuchte
PL Diodowa lampa warsztatowa akumulatorowa
RUS Светодиодная лампа LED

CZ Ruční svítilna LED
H LED szerelő lámpák
RO Lampa portabila cu acumulator leduri
F Lampe a LED rechargeable

I Lampada LED trasportabile per illuminazione di vani motore
E Linterna LED recargable
CN 引擎盖检修灯

SMD



12W	1200 lm	4000 K	230V~50Hz	CABLE HOSRN-F KABEL
5m	2x 1.0mm ²	POLYCARBONATE DIFFUSER KLOZS Z POLIKARBONÁTU	HOOK HAK	IP54

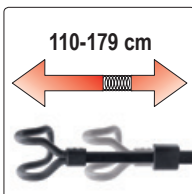

YATO	8
YT-08532	

- GB LED Flashlight
- D LED Taschenlampe
- PL Latarka LED
- RUS Светодиодный фонарь
- CZ LED svítilna
- H LED zseblámpa
- RO Lanterna cu LED
- F LED lampe de torche

- I Torcia LED
- E Linterna LED
- CN 手电筒

6W	XPG3	500 lm	230 m
4 LIGHTING MODES TRYBY SVÍCENÍ	IPX7	6V 4x AA	

POWER LED



DOUBLE BLISTER



YATO	W	lm	
YT-08564	6	500	6/24

- GB LED Flashlight
- D LED Taschenlampe
- PL Latarka LED
- RUS Светодиодный фонарь
- CZ LED svítilna
- H LED zseblámpa

- RO Lanterna cu LED
- F LED lampe de torche
- I Torcia LED
- E Linterna LED
- CN 手电筒

10W	XPL	1000 lm	350 m
3 LIGHTING MODES TRYBY SVÍCENÍ	ZOOM	IPX4	6V 4x C/R14

POWER LED



DOUBLE BLISTER



YATO	W	lm	
YT-08567	10	1000	8/16

- GB LED Flashlight
- D LED Taschenlampe
- PL Latarka LED
- RUS Светодиодный фонарь
- CZ LED svítilna
- H LED zseblámpa
- RO Lanterna cu LED
- F LED lampe de torche

- I Torcia LED
- E Linterna LED
- CN 手电筒

3W	XPE2	200 lm	120 m
ZOOM	IPX4	3V 2x AA	2 LIGHTING MODES TRYBY SVÍCENÍ

POWER LED



DOUBLE BLISTER



YATO	W	lm	
YT-08565	3	200	8/64

- GB LED Flashlight
- D LED Taschenlampe
- PL Latarka LED
- RUS Светодиодный фонарь
- CZ LED svítilna
- H LED zseblámpa
- RO Lanterna cu LED
- F LED lampe de torche

- I Torcia LED
- E Linterna LED
- CN 手电筒

5W	XPG2	300 lm	150 m
ZOOM	IPX4	4.5V 3x AAA	3 LIGHTING MODES TRYBY SVÍCENÍ

POWER LED



DOUBLE BLISTER



YATO	W	lm	
YT-08566	5	300	8/64

- GB LED Flashlight
- D LED Taschenlampe
- PL Latarka LED
- RUS Светодиодный фонарь
- CZ LED svítilna
- H LED zseblámpa
- RO Lanterna cu LED
- F LED lampe de torche
- I Torcia LED

- E Linterna LED
- CN 手电筒

6W	XPG3	500 lm	200 m
ZOOM	IPX7	3.7V 2200mAh Li-Ion	3 LIGHTING MODES TRYBY SVÍCENÍ
		USB BATTERY CHARGER LADOWARKA	

POWER LED



DOUBLE BLISTER



YATO	W	lm	
YT-08568	6	500	6/24

- GB LED Flashlight
- D LED Taschenlampe
- PL Latarka LED
- RUS Светодиодный фонарь
- CZ LED svítilna
- H LED zseblámpa
- RO Lanterna cu LED

- F LED lampe de torche
- I Torcia LED
- E Linterna LED
- CN 手电筒

5W	XTE	350 lm	150 m
ZOOM	IPX4	3.7V 650mAh Li-Ion	4 LIGHTING MODES TRYBY SVÍCENÍ
		USB BATTERY CHARGER LADOWARKA	

POWER LED



SLIDING CARD



YATO	W	lm	
YT-08569	5	350	12/96

- GB LED Flashlight
- D LED Taschenlampe
- PL Latarka LED
- RUS Светодиодный фонарь
- CZ LED svítilna
- H LED zseblámpa

- RO Lanterna cu LED
- F LED lampe de torche
- I Torcia LED
- E Linterna LED
- CN 手电筒

3W	130 lm	ZOOM
IP64	1.5V 2x C	WATER PROOF ODPORNÁ NA WODĘ

POWER LED



SLIDING CARD



YATO	W	lm	
YT-08577	3	130	12/48

- GB LED Flashlight
- D LED Taschenlampe
- PL Latarka LED
- RUS Светодиодный фонарь
- CZ LED svítilna
- H LED zseblámpa

- RO Lanterna cu LED
- F LED lampe de torche
- I Torcia LED
- E Linterna LED
- CN 手电筒

3W	100 lm	ZOOM
IP64	1.5V 2x AA	WATER PROOF ODPORNÁ NA WODĘ

POWER LED



SLIDING CARD



YATO	W	lm	
YT-08575	3	100	12/72

- GB LED Flashlight
D LED Taschenlampe
PL Latarka LED
RUS Светодиодный фонарь
CZ LED svítilna
H LED zseblámpa

- RO Lanterna cu LED
F LED lampe de torche
I Torcia LED
E Linterna LED
CN 手电筒

3W 110 lm ZOOM IP64 1.5V AA WATER PROOF ODPORNA NA WODĘ

POWER LED



SLIDING CARD



YATO	W	lm	
YT-08572	3	110	12/72

- GB LED Flashlight
D LED Taschenlampe
PL Latarka LED
RUS Светодиодный фонарь
CZ LED svítilna
H LED zseblámpa

- RO Lanterna cu LED
F LED lampe de torche
I Torcia LED
E Linterna LED
CN 手电筒

3W 100 lm ZOOM IP64 1.5V AA WATER PROOF ODPORNA NA WODĘ

POWER LED



SLIDING CARD



YATO	W	lm	
YT-08571	3	100	24/96

- GB LED Flashlight
D LED Taschenlampe
PL Latarka LED
RUS Светодиодный фонарь
CZ LED svítilna
H LED zseblámpa
RO Lanterna cu LED
F LED lampe de torche
I Torcia LED
E Linterna LED
CN 手电筒



9 LED 1.5V 3x AAA WATER PROOF ODPORNA NA WODĘ

SLIDING CARD



YATO		
YT-08570		24/192

- GB Automotive circuit tester
D KFZ Prüflampe
PL Wskaźnik elektryczny samochodowy
RUS Пробник напряжения автомобильный
CZ Zkoušečka napětí autoelektrikářská
H Autóvillamosági teszter
RO Tester pt. circuite auto
F Testeur de tension de voiture
I Tester elettrico per auto
E Indicador eléctrico de coche
CN 汽车测电笔

SLIDING CARD



CABLE KABEL 90 cm

LED



6-24 V

YATO	
YT-2865	25/250

- GB LED head lamp
D LED kopflampe
PL Diodowa lampka czołowa
RUS Налобный светодиодный фонарь
CZ LED montážní lampka - čelovka
H LED fejlámpa
RO Lampa cu LED
F Lampe frontale LED
I Lampada da testa
E Linterna de diodo
CN LED头灯



10W XM-L2 450 lm ZOOM 3 LIGHTING MODES TRYBY SWIECENIA 6V 4x AAA

POWER LED

DOUBLE BLISTER



YATO	W	lm	
YT-08591	10	450	6/24

- GB LED head lamp
D LED kopflampe
PL Diodowa lampka czołowa
RUS Налобный светодиодный фонарь
CZ LED montážní lampka - čelovka
H LED fejlámpa
RO Lampa cu LED
F Lampe frontale LED
I Lampada da testa
E Linterna de diodo
CN LED头灯



3W 100 lm ZOOM WATER PROOF ODPORNA NA WODĘ 1.5V 3x AAA

POWER LED

SLIDING CARD



YATO	W	lm	
YT-08590	3	100	25/100



6-12 V

YATO	
YT-2866	10/100

- GB Number stamp
- D Nummernstempel
- PL Znaczniki cyfrowe
- RUS Клейма цифровые
- CZ Razidla číselná
- H Számbeütők
- RO Poansoare cu cifre
- F Chiffres à frapper
- I Punzoni marcatori
- E Marcadores de números
- CN 数字冲模

9 PCS
NUMBERS
NUMERY
0 - 9
1045
CARBON
STEEL
HRC
50-55



PLASTIC BOX & COLOR SLEEVE

YATO	No (mm)	PCS packing	
YT-6854	6	9	20
YT-6855	8	9	18

- GB Letter stamp
- D Buchstabenstempel
- PL Znaczniki literowe
- RUS Клейма буквенные
- CZ Razidla písmenová
- H Betűbeütők
- RO Poansoare cu litere
- F Lettres à frapper
- I Punzoni marcatori
- E Marcadores de letras
- CN 字母冲模

27 PCS
LETTERS
LITERY
A - Z | &
1045
CARBON
STEEL
HRC
50-55



PLASTIC BOX & COLOR SLEEVE

YATO	No (mm)	PCS packing	
YT-6862	6	27	12
YT-6863	8	27	8

- GB Thread repair set
- D Reparatursatz für Gewinde
- PL Zestaw do naprawy gwintów
- RUS Набор для ремонта резьбы
- CZ Souprava na opravu závitů
- H Menetjavító készlet
- RO Set pt. reparare filete
- F Set d'helicoils
- I Kit di riparazione per filettature
- E Juego para reparar roscas
- CN 螺纹修复组套



METAL BOX & COLOR BOX

HSS
4341
STAINLESS
STEEL
STAL
NERZEWA

88
PCS

YATO	size / rozmiar	
YT-1769	M6 x 1.0 x 10.8 mm	5/10
	M8 x 1.25 x 10.8 mm	
	M10 x 1.5 x 13.5 mm	



131
PCS

YATO	size / rozmiar	
YT-1763	M5 x 0.8 x 6.7 mm	5/10
	M6 x 1.0 x 10.8 mm	
	M8 x 1.25 x 10.8 mm	
	M10 x 1.5 x 13.5 mm	
	M12 x 1.75 x 16.3 mm	

- GB Wire threads
- D Spiraleinlagen für Gewindereparatur
- PL Wkłady spiralne do naprawy gwintów
- RUS Метчики и сверла для ремонта резьбы
- CZ Spirálové vložky na opravu závitů
- H Menetjavító betétek

- RO Inserții spirală pt. reparare filete
- F Helicoil
- I Inserti a spirale per riparazione
- E Elementos espirales para reparar roscas
- CN 不锈钢螺纹套

POLYBAG WITH HEADER



for / dla: YT-1763, YT-1769

STAINLESS
STEEL
STAL
NERZEWA



YATO	size / rozmiar	PCS packing	
YT-1764	M5 x 0.8 x 6.7 mm	20	50/250
YT-1765	M6 x 1.0 x 10.8 mm	20	50/250
YT-1766	M8 x 1.25 x 10.8 mm	20	50/200
YT-1767	M10 x 1.5 x 13.5 mm	15	25/100
YT-1768	M12 x 1.75 x 16.3 mm	10	25/100

- GB Dual foot tire gauge
- D Reifendruckprüfer
- PL Ciśnieniomierz do aut ciężarowych
- RUS Манометр для грузовых автомобилей
- CZ Tlakomer na nákladní auta
- H Nyomásmérő tehergépkocsikhoz
- RO Indicator de presiune pt. camioane
- F Manometre pneu pour camions
- I Manometro per automezzi
- E Manómetro de caomones
- CN 胎压表



0-15 bar 0-220 PSI FOR TRUCKS DO SAMOCHODÓW CIĘŻAROWYCH 140 mm

SLIDING CARD

YATO	
YT-24301	25/100

- GB** Foot pump with gauge
D Fusspumpe
PL Pompka nożna z manometrem
RUS Насос ножный с манометром
CZ Nožní pumpa z manometrem
H Lábpumpa nyomásmérővel

- RO** Pompă de picior cu manometru
F Pompe à pied avec manomètre
I Pompa a pedale con manometro
E Bomba de pierna con manometro
CN 打气筒



COLOR BOX

YATO 	
YT-7349	10

- GB** Foot pump with gauge
D Fusspumpe
PL Pompka nożna z manometrem
RUS Насос ножный для СТО
CZ Nožní pumpa z manometrem
H Lábpumpa nyomásmérővel
RO Pompă de picior cu manometru

- F** Pompe à pied avec manomètre
I Pompa a pedale con manometro
E Bomba de pierna con manometro
CN 打气筒



TWIN PISTON
PODWÓJNY TŁOK



COLOR BOX

YATO 	
YT-7350	10

- GB** Oil jug
D Ölkanne
PL Nalewak warsztatowy
RUS Лейка пластиковая с крышкой для СТО
CZ Odměrka plastová - konev
H Olajbetöltő kanna
RO Recipient ulei
F Broc verseur avec couvercle
I Serbatoio
E Jarra con pitorro de aceite
CN 塑料油壺





FLEXI SPOUT
ELASTYCZNY LEJEK

FOR AUTOMOTIVE FLUIDS
DO PŁYNÓW EKSPLOATACYJNYCH

POLYBAG



YATO 	I	
YT-06980	1	48
YT-06983	3	40
YT-06985	5	16

- GB** Hand pump with manometer
D Hand-Luftpumpe mit Manometer
PL Pompka słupkowa z manometrem
RUS Насос ручной с манометром
CZ Pumpa z manometrem
H Kézi pumpa manométerrel

- RO** Pompa de mana cu manometru
F Pompe manuelle avec manomètre
I Pompa verticale con manometro
E Bomba de barrote con manometro
CN 带压力表打气筒



PLASTIC HANGER & TAG CARD



YATO 	
YT-7352	6

GB Funnel
D Trichter
PL Lejek
RUS Воронка гибкая
CZ Nálevka
H Kétrészes tölcser
RO Pálnie
F Entonnoir
I Imbuto
E Embudo
CN 漏斗



Ø
135mm
PP

YATO	Ø (mm)	
YT-0694	135	192

GB Long funnel
D Trichter
PL Lejek dlugi
RUS Воронка гибкая
CZ Nálevka
H Kétrészes tölcser
RO Pálnie
F Entonnoir
I Imbuto
E Embudo
CN 漏斗



Ø
120mm
PP

YATO	L (mm)	Ø (mm)	
YT-0693	455	120	48

GB Operating fluids funnel
D Trichter
PL Lejek do płynów eksploatacyjnych
RUS Воронка гибкая
CZ Nálevka
H Kétrészes tölcser
RO Pálnie
F Entonnoir
I Imbuto
E Embudo
CN 漏斗



Ø
100mm
PP

YATO	Ø (mm)	
YT-0695	100	180

GB Operating fluids funnel
D Trichter
PL Lejek do płynów eksploatacyjnych
RUS Воронка гибкая
CZ Nálevka
H Kétrészes tölcser
RO Pálnie
F Entonnoir
I Imbuto
E Embudo
CN 漏斗



Ø
240mm
PP

YATO	Ø (mm)	
YT-0696	240	48

GB Fuel and oil funnel
D Trichter
PL Lejek do paliwa i oleju eksploatacyjnych
RUS Воронка гибкая
CZ Nálevka
H Kétrészes tölcser
RO Pálnie
F Entonnoir pour essence et huile
I Imbuto
E Embudo
CN 漏斗



Ø
150mm
PP

YATO	Ø (mm)	
YT-0692	150	30

GB Oil funnel
D Trichter
PL Lejek do oleju
RUS Воронка гибкая
CZ Nálevka
H Kétrészes tölcser
RO Pálnie
F Entonnoir
I Imbuto
E Embudo
CN 漏斗



Ø
280mm
PP

YATO	Ø (mm)	
YT-0697	280	48

GB Oil drain pan
D Ölwanne
PL Miska do oleju
RUS Миска для масла
CZ Miska na olej
H Fáradtolaj felfogó edény
RO Recipient pt. ulei
F Bol à l'huile
I Vaschetta per cambio olio
E Escudilla para aceite
CN 接油盆



PP

YATO	l	Ø (cm)	
YT-0699	7	37	48



PE

YATO	l	Ø (cm)	
YT-0716	10	37	6
YT-0717	15	42	4

GB Oil drainer
D Ölefüllanlage
PL Zlewarka do oleju
RUS Устройство для слива масла
CZ Olejová nádrž s odsáváním
H Fáradtolaj leszívó
RO Dispozitiv pt. schimbat ulei
F Récupérateur d'huile
I Scolapiatti dell'olio
E Decantador para aceite
CN 泄油器



75-155 cm
PE

WHITE CARTON BOX & COLOR LABEL





YATO	l	Ø (cm)	
YT-0718	20	42	1

GB Hydraulic bottle jack
D Hydraulischer Stempelwagenheber
PL Podnośnik hydrauliczny słupkowy
RUS Домкрат гидравлический
CZ Pistový zvedák hydraulický
H Hidraulikus emelő

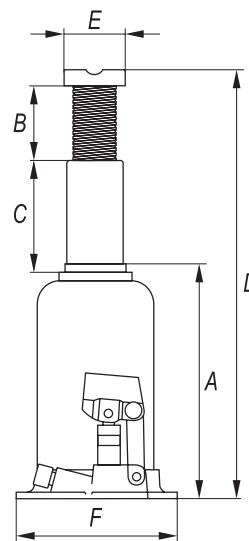
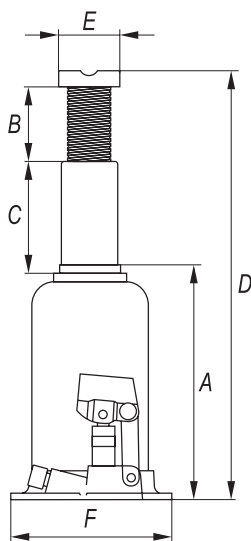

RO Cric hidraulic
F Elévateur
I Cric idraulico a bottiglia
E Gato de embolo hidr.
CN 立式液压千斤顶

COLOR BOX



YATO 	T	A (mm)	B (mm)	C (mm)	D (mm)	E (mm)	F (mm)	
YT-17000	2	181	48	164	345	25	88x92	6
YT-17001	3	194	60	180	374	27	92x100	6
YT-17002	5	216	60	180	413	29	96x110	4
YT-17003	8	230	80	147	457	32	103x118	2
YT-17004	10	230	80	150	460	36	110x123	2
YT-17005	12	230	80	155	465	40	116x134	2
YT-17006	15	230	82	150	462	43	140x134	2
YT-17007	20	242	60	150	452	45	144x150	2
YT-17008	32	285	-	180	465	69	190x152	1
YT-17009	50	300	-	180	480	83	218x176	1

ELECTROLESS NICKEL PLATING

YATO 	T	A (mm)	B (mm)	C (mm)	D (mm)	E (mm)	F (mm)	
YT-1702	5	212	110	146	468	40	110x112	5
YT-1704	10	220	115	148	483	48	124x127.5	3
YT-1706	15	231	113	154	498	56	140x142	2
YT-1707	20	241	115	165	521	60	165x161	2
YT-1709	30	244	108	140	492	65	186x174	1

GB Two-piston hydraulic bottle jack
D Hydraulischer Stempelwagenheber
PL Podnośnik hydrauliczny słupkowy dwutiokowy
RUS Домкрат гидравлический
CZ Pistový zvedák hydraulický



H Hidraulikus emelő
RO Cric hidraulic
F Elévateur deux niveaux
I Cric idraulico a bottiglia
E Gato de embolo hidr.
CN 液压双级千斤顶



COLOR BOX

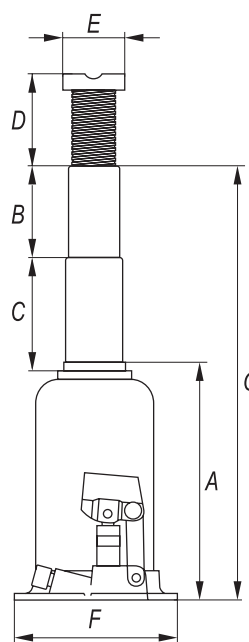
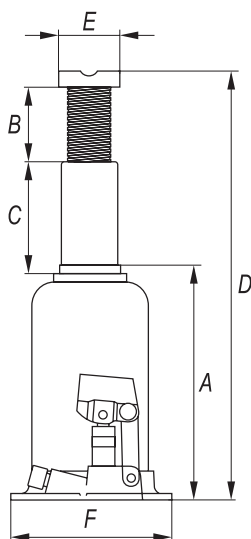

ELECTROLESS NICKEL PLATING



YATO 	T	A (mm)	B (mm)	C (mm)	D (mm)	E (mm)	F (mm)	
YT-1711	5	222	146	138	500	41	130x136	2
YT-1713	10	128	63	38	223	47	160x165	2

YATO 	T	A (mm)	B (mm)	C (mm)	D (mm)	E (mm)	F (mm)	G (mm)	
YT-1714	10	210	120	118	78	48	165x161	442	1
YT-1715	12	236	138	128	98	56	186x174.5	498	1

- GB Hydraulic floor jack
- D Hydraulischer Rangierwagenheber
- PL Podnośnik hydrauliczny
- RUS Домкрат гидравлический
- CZ Pístový zvedák hydraulický
- H Krokodil emelő
- RO Cric tip crocodil
- F Elévateur hydraulique
- I Sollevatore idraulico
- E Gato de embolo hidr.
- CN 卧式液压千斤顶





LOW PROFILE

2t

359 mm
↑
89 mm

BMC & COLOR SLEEVE



YATO 	T	
YT-1720	2	1



2.5t

457 mm
↑
89 mm

COLOR BOX



YATO 	T	
YT-1721	2.5	1



3t

465 mm
↑
130 mm

COLOR BOX



YATO 	T	
YT-17211	3	1

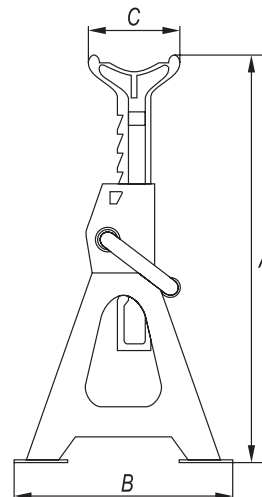

16

- GB Jack stand
- D Unterstellböcke
- PL Podstawka pod samochód
- RUS Подставка под автомобиль
- CZ Podstavec pod auto
- H Gépkocsi alátét
- RO Chituc de metal
- F Paire de chandelles
- I Coppia cavalletti
- E Apoyos de coche
- CN 千斤顶支架



COLOR BOX



YATO 	T	A (mm)	B (mm)	C (mm)	PCS packing	
YT-17310	2	265-415	190x165	77x40	2	1
YT-17311	3	280-420	182x201	85x29	2	1
YT-17312	6	382-600	258x285	100x29	2	1

GB Electronic battery charger
D Elektronisches Ladegerät
PL Prostownik elektroniczny
RUS Электронное зарядное устройство
CZ Elektronická nabíječka

H Elektronikus akkumulátortöltő
RO Redresor electric
F Chargeur de batterie voiture
I Avviatore elettronico
E Rectificador electrónico
CN 蓄电池充电器

6 V	1 A
12 V	4 A
200 Ah max	220-240V~50Hz
WET GEL AGM	MOKRY ZELOWY AGM



230V~50Hz	5-160 Ah
2 A	12 V
8 A	
WET GEL AGM	MOKRY ZELOWY AGM



COLOR BOX



HANGING COLOR BOX WITH WINDOW



YATO
YT-8300 8

YATO
YT-83016 12



12 V	4 A
5-120 Ah	220-240 V~50 Hz
WET GEL AGM	MOKRY ZELOWY AGM



HANGING COLOR BOX WITH WINDOW



6 V	4 A
12 V	
5-120 Ah	220-240 V~50 Hz
WET GEL AGM	MOKRY ZELOWY AGM



HANGING COLOR BOX WITH WINDOW



YATO
YT-83031 30

YATO
YT-83032 30



6 V	1 A
12 V	4 A
120 Ah max	220-240 V~50/60 Hz
WET GEL AGM	MOKRY ZELOWY AGM



ALTERNATOR TEST TEST ALTERNATORA
STARTER TEST TEST ROZRUSZNIKA

HANGING COLOR BOX



YATO
YT-83033 8



6 V	8 A
12 V	
5-200 Ah	220-240V~50Hz
WET GEL AGM	MOKRY ZELOWY AGM



COLOR BOX



YATO
YT-8301 8

GB Electronic battery charger
D Elektronisches Ladegerät
PL Prostownik elektroniczny
RUS Электронное зарядное устройство

CZ Elektronická nabíječka
H Elektronikus akkumulátortöltő
RO Redresor electric
F Chargeur de batterie voiture

I Aviatore elettronico
E Rectificador electrónico
CN 蓄电池充电器

COLOR BOX



12 V **12 A**
6-200 Ah **220-240V~ 47-63 Hz**
WET MOKRY

12 V
15 A **6-200 Ah**
220-240V~ 47-63 Hz
WET GEL AGM
MOKRY ZELOWY AGM

YATO **YT-8302** 8

YATO **YT-8303** 8

GB Battery charger with boost function
D Ladegerät mit Boost-Funktion
PL Prostownik z funkcją wspomagania ładowania
RUS Выпрямитель с функцией поддержки зарядки
CZ Nabíječky s funkcií boost
H Akkumulátortöltő boost funkció

RO Redresor baterie cu functie boost
F Chargeur de batterie voiture support boost
I Carica batterie con boost
E Cargador de baterias arrancador boost
CN 充电器

COLOR BOX



230V~ 50Hz **12 V 24 V**



16 A **120-240 Ah** **WET MOKRY**

25 A **170-350 Ah** **WET MOKRY**

YATO **YT-8304** 2

YATO **YT-8305** 2



15 A **10-300 Ah** **WET MOKRY AGM** **BOOST ROZRUCH 12 V 75 A**

30 A **50-600 Ah** **WET MOKRY AGM** **BOOST ROZRUCH 12 V 145 A**

YATO **YT-83051** 2

YATO **YT-83052** 2

GB Battery charger with engine start-up supporting function
D Ladegerät mit Starthilfe
PL Prostownik z funkcją wspomagania rozruchu
RUS Выпрямитель с функцией поддержки запуска
CZ Nabíječky s funkcií startování motoru
H Akkumulátortöltő indító

RO Redresor cu funcția de pornire de sprijin
F Chargeur de batterie voiture support démarrage
I Carica batterie carrellato con funzione di avviatore rapido
E Cargador de baterías arrancador
CN 充电器启动机

COLOR BOX



230V~
50Hz WET
MOKRY



12 V 27 A
START / ROZRUCH
300 A

24 V 25 A
START / ROZRUCH
240 A

20-600
Ah



12 V 32 A
START / ROZRUCH
390 A

24 V 31 A
START / ROZRUCH
360 A

20-700
Ah



12 V 38 A
START / ROZRUCH
540 A

24 V 35 A
START / ROZRUCH
450 A

20-800
Ah

YATO 1
YT-83060

YATO 1
YT-83061

YATO 1
YT-83062

GB Jump starter power bank
D Multifunktions-Startgerät
PL Urządzenie rozruchowe wielofunkcyjne
RUS Портативное пусковое-зарядное устройство
CZ Power banka s možností nastartování auta
H Indító bikázó starter
RO Acumulator extern pt. pornire motor si incarcare
F Portable demarreur batterie voiture booster
I Dispositivo di avviamento multifunzione
E Coche portátil salto de arranque
CN 应急电源



COLOR BOX



7500 mAh 2h
QUICK CHARGING SYSTEM LAZOWANIE



9000 mAh 12V / 3.5A OUTPUT WYJSCIE 3h
SAMA CHARGING SYSTEM LAZOWANIE

YATO 20
YT-83080

YATO 10
YT-83081

GB Power inverter
D Spannungswandler
PL Przetwornica napięcia
RUS Автомобильный инвертор
CZ Měníč napětí
H Feszültség átalakító
RO Convertor de tensiune
F Convertisseur de tension
I Inverter di corrente
E Convertidor de voltaje
CN 逆变器

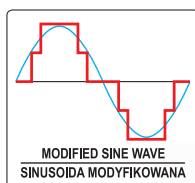

COLOR BOX



12V INPUT WEJSCIE 220-240V-50 Hz OUTPUT WYJSCIE THERMAL PROTECTION ZABEZPIECZENIE TERMICZNE LOW VOLTAGE LEVEL SIGNAL SYGNAŁ NISKIEGO POZIOMU NAPIĘCIA



500 W 1000 W PEAK SZCZYT.



800 W 1600 W PEAK SZCZYT.

YATO 12
YT-81490

YATO 12
YT-81491

GB Jumpstart wires
D Starterkabel
PL Przewody rozruchowe
RUS Пусковые провода
CZ Startovací kabely
H Indító kábelek
RO Cabluri demarare
F Câbles de démarrage

I Cavi carica batteria
E Cables de arranque
CN 输出线

WINDOW BAG
WITH ZIPPER

2.5m



YATO	rated load / obciążenie nominalne (A)	
YT-83151	200	12

YATO	rated load / obciążenie nominalne (A)	
YT-83152	400	12

YATO	rated load / obciążenie nominalne (A)	
YT-83153	600	12

GB Analogue battery tester
D Analoges Batterieprüfgerät
PL Tester akumulatorów analogowy
RUS Аналоговый тестер аккумуляторов
CZ Analogový tester akumulátorů
H Analóg akkuteszter
RO Tester acumulatori analog
F Testeur de charge batterie
I Tester analogico per batteria
E Tester analógico para acumuladores
CN 电池测试器

6 V

12 V

CCA
200-
1000 A



COLOR
BOX

YATO	
YT-8310	10

GB Digital battery tester
D Digitales Batterieprüfgerät
PL Tester akumulatorów cyfrowy
RUS Цифровой тестер аккумуляторов
CZ Digitální tester akumulátorů
H Digitális akkuteszter
RO Tester acumulatori digital
F Testeur digital de charge batterie
I Tester digitale per batteria
E Tester digital para acumuladores
CN 电池测试器

12 V

LED
DISPLAY

CCA
150-
1400 A



COLOR
BOX

YATO	
YT-8311	10

GB Battery tester
D Batterieprüfgerät
PL Tester akumulatorów
RUS Тестер аккумуляторов
CZ Tester akumulátorů
H Akkuteszter
RO Tester acumulatori
F Testeur électronique de charge
batterie et alternateur
I Tester per batteria
E Tester para acumuladores
CN 电池测试器

12 V

BATTERY
TEST
TEST
AKUMULATORA

ALTERNATOR
TEST
TEST
ALTERNATORA



DOUBLE
BLISTER

YATO	
YT-83101	12/72

GB Refractometer
D Refraktometer
PL Refraktometr
RUS Рефрактометр
CZ Refraktometer
H Fagyálló fokoló
RO Refractometrul
F Réfractomètre
I Rifrattometro
E Refractometro
CN 冰点仪



PLASTIC BOX
& COLOR SLEEVE

YATO	
YT-06722	20

- GB** Chain block
D Kettenzug Flaschenzug
PL Wyciągarka łańcuchowa
RUS Таль цепная
CZ Zvedák řetězový
H Láncos csigasor emelő
RO Scripete cu lant
F Treuil à chaîne
I Paranco a catena
E Cabria de cadena
CN 手拉葫芦



3m

GREY
CARTON BOX
& COLOR LABEL

YATO	max. load capacity / max. ładowność (kg)	
YT-58950	500	1
YT-58951	1000	1
YT-58953	2000	1
YT-58954	3000	1
YT-58955	5000	1

PLYWOOD BOX
& COLOR LABEL

YATO	max. load capacity / max. ładowność (kg)	
YT-58957	10000	1

- GB** Electric hoist
D Elektro-Seilwinde
PL Elektryczny wciągnik linowy
RUS Электрическая канатная лебедка
CZ Elektrický naviják kladkostroj
H Elektromos csőrő
RO Troliu electric cu cablu
F Treuil électrique à corde
I Verricello elettrico
E Cabria eléctrica de cuerdas
CN 电动葫芦



COLOR
BOX

YATO	max. lifting capacity / max. udźwig (kg)	
YT-58962	750	1
YT-58964	1500	1
YT-58966	3000	1
YT-58967	6000	1

YATO	max. load capacity / max. ładowność (kg)	
YT-58968	9000	1

YATO	max. lifting capacity / max. udźwig (kg)	
YT-5901	125 kg / 250 kg	2
YT-5902	150 kg / 300 kg	2
YT-5904	250 kg / 500 kg	2
YT-5905	300 kg / 600 kg	2

230V~50Hz
STOP

500 W
125 kg / 250 kg

$L_{pA} \leq 70$ dB;
 $L_{wA} \leq 85$ dB

8 m/min max. 11m / 4 m/min max. 5.5m
125 kg / 250 kg

550 W
150 kg / 300 kg

$L_{pA} \leq 70$ dB;
 $L_{wA} \leq 85$ dB

8 m/min max. 11m / 4 m/min max. 5.5m
150 kg / 300 kg

900 W
250 kg / 500 kg

$L_{pA} \leq 70$ dB;
 $L_{wA} \leq 85$ dB

8 m/min max. 11m / 4 m/min max. 5.5m
250 kg / 500 kg

1050 W
300 kg / 600 kg

$L_{pA} \leq 70$ dB;
 $L_{wA} \leq 85$ dB

8 m/min max. 11m / 4 m/min max. 5.5m
300 kg / 600 kg

GB Rope winch
D Handseilwinde
PL Wyciągarka linowa

RUS Канатная лебедка
CZ Lanové vyťahovací zařízení
H Drótköteles csőrlő



RO Troliu cu cablu orizontal
F Treuil à corde
I Paranco a corda

E Cabria de cuerdas
CN 繩索拉緊器

COLOR BOX





1000
daN

YATO 	daN	L (m)	Ø (mm)	
YT-5911	1000	3	5	6





1300
daN

YATO 	daN	L (m)	Ø (mm)	
YT-5913	1300	3	5	6



1500
daN

YATO 	daN	L (m)	Ø (mm)	
YT-5914	1500	3	6	3

GB Shop crane
D Werkstattkran
PL Żuraw warsztatowy
RUS Кран подкатной гидравлический
CZ Hydraulický jeřáb
H Motorkiemelő zsráf

RO Girafa pt. scos motor
F Grue d'atelier
I Gru idraulica
E Grúa hidráulica para motores
CN 吊机

GREY CARTON BOX & COLOR LABEL



210cm
max

1000
kg

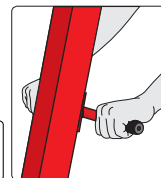

YATO 	
YT-55556	1



230cm
max

2000
kg

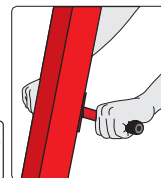

YATO 	
YT-55557	1

GB Shop press
D Hydraulische Werkstattpresse
PL Prasa hydrauliczna

RUS Гидравлический пресс
CZ Hydraulický lis
H Hidraulikus prés
RO Presa hidraulică

F Presse hydraulique
I Pressa idraulica
E Prensa de hidráulica
CN 压力机

GREY CARTON BOX
& COLOR LABEL



12t

0-695 mm

400 mm

20t

0-695 mm

490 mm



30t

0-795 mm

520 mm



YATO  
YT-55580 1

YATO  
YT-55581 1

YATO  
YT-55582 1

GB Engine suspension beam
D Aufnahmevorrichtung des Motors
PL Belka do podwieszenia silnika
RUS Балка для вывешивания двигателя
CZ Nosník k zavěšení motoru
H Motorfelfüggesztő gerenda

RO Grindă pt. suspendarea motorului
F Poutre de suspension de moteur
I Fascio sospensione del motore
E La viga para suspender el motor
CN 发动机平衡架

500kg max. **150cm**

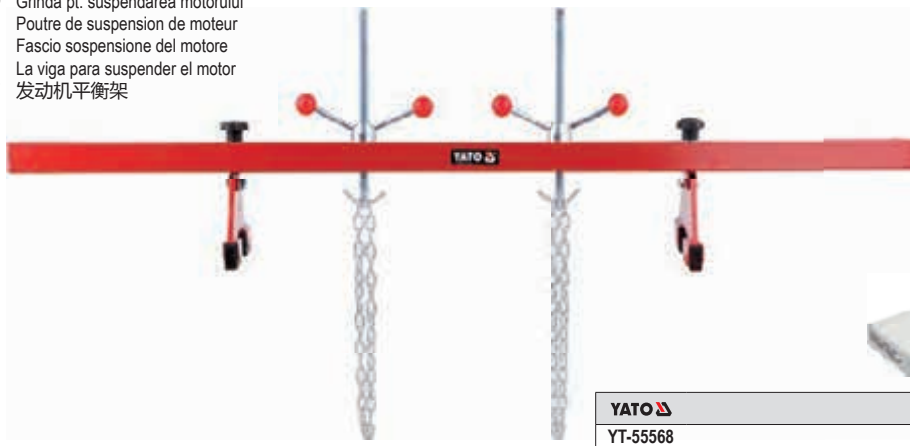
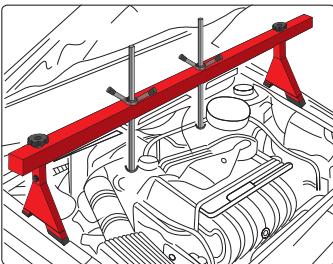

WHITE CARTON BOX
& COLOR LABEL



YATO  
YT-55568 1

GB Crane crossbeam
D Traverse zum Kran
PL Trawers do żurawia
RUS Траверса для крана
CZ Jelábóvá traverza
H Traverz a zsiráf emelőhöz
RO Traversă pt. macara
F Balancier pour grue d'atelier
I Traverse per gru
E Viga transversal para grua
CN 平衡器



680kg **315mm**

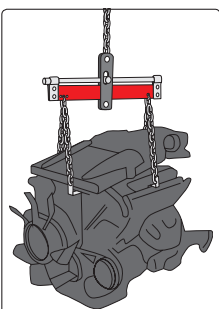

WHITE CARTON BOX
& COLOR LABEL



YATO  
YT-55565 1

GB Engine stand
D Motorständer
PL Stojak do silnika
RUS Стойка для ремонта двигателя
CZ Stojan na motor
H Motorszerelő állvány

RO Suport pt. motor
F Support moteur
I Cavalletto per motore
E Soporte de motor
CN 发动机支架

450kg **STEEL WHEELS x4** **360°**



GREY CARTON BOX
& COLOR LABEL



YATO  
YT-55570 1

GB Self locking nuts assortment
D Sortiment Muttern metrisch mit Sicherheit
PL Zestaw nakrętek metrycznych z zabezpieczeniem

RUS Набор гаек самоконтращиеся, с нейлоновой вставкой
CZ Šestihranné matice s bezpečností
H Nuts metrikus menet biztonsági
RO Set piulite autoblocante

F Hex écrou set avec la sécurité
I Set di autobloccanti metrica dadi
E Porcas rosca métrica com a segurança
CN 146件套螺母组套

PLASTIC HANGING BOX



146 PCS

INSERT LOCK ZABEZPEČENIE

MIX SIZE ROZMĚRŮV



M4, M5, M6, M8, M10, M12

YATO YT-06774 5/20

GB Metric nuts assortment
D Sortiment Muttern metrisch
PL Zestaw nakrętek metrycznych
RUS Набор гаек

CZ Šestihranné matice
H Nuts metrikus menet
RO Set piulite
F Hex écrou set

I Set di metrica dadi
E Porcas rosca métrica
CN 300件套螺母组套

PLASTIC HANGING BOX



300 PCS

MIX SIZE ROZMĚRŮV



M3, M4, M5, M6, M8, M10

YATO YT-06772 5/20

GB Stainless steel nuts assortment
D Sortiment Muttern metrisch rostfrei
PL Zestaw nakrętek metrycznych nierdzewnych
RUS Набор гаек шестигранных нержавеющей

CZ Nerezové oceli šestihranné matice
H Nuts metrikus menet rozsdamentes
RO Set piulite inox
F Hex écrou set inoxydable

I Set di acciaio inossidabile metrica dadi
E Rosca métrica tuerca inoxidable
CN 300件套不锈钢螺母组套

PLASTIC HANGING BOX



300 PCS

MIX SIZE ROZMĚRŮV

STAINLESS STEEL STAL NIERDZEWNA



M3, M4, M5, M6, M8, M10

YATO YT-06773 5/20

GB Hex nut with top assortment
D Sortiment Muttern metrisch geschlossen
PL Zestaw nakrętek metrycznych kolpakowych

RUS Набор гаек колпачковых
CZ Šestihranné matice zavřeno
H Nuts metrikus menet zárt
RO Set piulite inchise

F Hex écrou set fermé
I Set di dadi campana-metrica
E Rosca métrica tuercas cerrado
CN 150件套不锈钢螺母组套

PLASTIC HANGING BOX



150 PCS

MIX SIZE ROZMĚRŮV



M3, M4, M5, M6, M8, M10

YATO YT-06775 5/20

GB Metric wing nut assortment
D Sortiment Flügelmutter
PL Zestaw nakrętek motylkowych
RUS Набор гаек типа «барашек»

CZ Křídlaté matice lisované
H Szárnyas anya
RO Set piulițe fluture
F Assortiment d'écrous papillon

I Set di metrica dadi
E Tuercas con orejas
CN 蝶形螺母

PLASTIC
HANGING BOX



150
PCS

MIX
SIZE
ROZMIAROW

METRIC
METRYCZNE

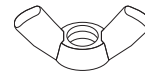

M4, M5, M6, M8, M10

YATO
YT-06776

25

GB Aluminium washer set
D Aluminium Dichtring Sortiment
PL Zestaw podkładek aluminiowych
RUS Набор алюминиевых шайб

CZ Sada hliníkových podložek
H Réz alátét készlet
RO Set saibe aluminii
F Assortiment de joints en aluminium

I Set di rondelle in alluminio
E Juego de arandelas de aluminio para tapones
CN 300件套铝垫片

PLASTIC BOX



300
PCS

MIX
SIZE
ROZMIAROW

METRIC
METRYCZNE

AI



10x 5x10x1.0 mm	10x 8x14x1.5 mm	10x 12x16x1.0 mm	10x 14x20x1.5 mm	10x 18x24x1.5 mm	10x 22x29x1.5 mm
10x 6x10x1.0 mm	10x 9x14x1.5 mm	10x 12x16x1.5 mm	10x 14x20x2.0 mm	10x 20x24.5x1.5 mm	10x 24x29x1.5 mm
10x 6x12x1.0 mm	10x 10x14x1.0 mm	10x 12x18x1.5 mm	10x 16x20x1.5 mm	10x 20x24.5x0.8 mm	10x 24x32x2.0 mm
10x 8x12x1.0 mm	10x 10x14x1.5 mm	10x 13x18x1.0 mm	10x 16x22x1.5 mm	10x 19x26x2.0 mm	10x 26x34x2.0 mm
10x 8x14x1.0 mm	10x 10x16x1.0 mm	10x 14x18x1.5 mm	10x 18x22x1.5 mm	10x 22x27x1.0 mm	10x 28x36x2.0 mm

5x9x1.0 mm, 8x14x1.5 mm, 12x16x1.0 mm, 14x20x1.5 mm, 18x24x1.5 mm, 22x29x1.5 mm, 6x10x1.0 mm, 9x14x1.0 mm, 12x16x1.5 mm, 14x20x2.0 mm, 20x24.5x1.5 mm, 24x29x1.5 mm, 6x12x1.0 mm, 10x14x1.0 mm, 12x18x1.5 mm, 16x20x1.5 mm, 20x24.5x0.8 mm, 24x32x2.0 mm, 8x12x1.0 mm, 10x14x1.5 mm, 13x18x1.0 mm, 16x22x1.5 mm, 19x26x2.0 mm, 26x34x2.0 mm, 8x14x1.0 mm, 10x16x1.0 mm, 14x18x1.5 mm, 18x22x1.5 mm, 22x27x1.0 mm, 28x36x2.0 mm

YATO
YT-06865

5/20

GB Copper washer set
D Kupfer Dichtring Sortiment
PL Zestaw podkładek miedzianych
RUS Набор колец медных

CZ Podložky měděné těsnící
H Réz tömítés készlet
RO Saibe din cupru
F Patins en cuivre

I Set di spessori
E Arandelas de cobre
CN 件套紫铜垫片

PLASTIC
HANGING BOX



150
PCS

MIX
SIZE
ROZMIAROW

Cu



5x10x1 mm 10 pcs	8x11x1 mm 10 pcs	11x17x1.5 mm 10 pcs	12.5x20x1.5 mm 10 pcs	15x20x2 mm 10 pcs	16.5x24x2 mm 10 pcs
6x10x1 mm 10 pcs	10x16x1 mm 10 pcs	14x18x1 mm 10 pcs	14x20x1.5 mm 10 pcs	16x22x2 mm 10 pcs	17.5x24x2 mm 10 pcs
7x10x1 mm 10 pcs	10.5x17x1.5 mm 10 pcs	12x20x1.5 mm 10 pcs	10 pcs	10 pcs	10 pcs

5x10x1.0 mm, 6x10x1.0 mm, 7x10x1.0 mm, 8x11x1.0 mm, 10x16x1.0 mm, 10.5x17x1.5 mm, 11x17x1.5 mm, 14x18x1.0 mm, 12x20x1.5 mm, 12.5x20x1.5 mm, 14x20x1.5 mm, 15x20x2.0 mm, 16x22x2.0 mm, 16.5x24x2.0 mm, 17.5x24x2.0 mm

YATO
YT-06871

5/20

GB Copper washer set
D Kupfer Dichtring Sortiment
PL Zestaw podkładek miedzianych
RUS Набор колец медных

CZ Podložky měděné těsnící
H Réz tömítés készlet
RO Saibe din cupru
F Patins en cuivre

I Set di spessori
E Arandelas de cobre
CN 件套紫铜垫片

PLASTIC BOX



300
PCS

MIX
SIZE
ROZMIARÓW

METRIC
METRYCZNE

SOFT
TYPE
MIEKKI
MATERIAL

Cu



10x 5x9x1.0 mm	10x 8x14x1.5 mm	10x 12x16x1.0 mm	10x 14x20x1.5 mm	10x 18x24x1.5 mm	10x 22x29x1.5 mm
10x 6x10x1.0 mm	10x 9x14x1.0 mm	10x 12x16x1.5 mm	10x 14x20x2.0 mm	10x 20x24x1.5 mm	10x 24x29x1.5 mm
10x 6x12x1.0 mm	10x 10x14x1.0 mm	10x 12x18x1.5 mm	10x 16x20x1.5 mm	10x 20x24x0.8 mm	10x 24x32x2.0 mm
10x 8x12x1.0 mm	10x 10x14x1.5 mm	10x 13x18x1.0 mm	10x 16x22x1.5 mm	10x 19x26x2.0 mm	10x 26x34x2.0 mm
10x 8x14x1.0 mm	10x 10x16x1.0 mm	10x 14x18x1.5 mm	10x 18x22x1.5 mm	10x 22x27x1.0 mm	10x 28x36x2.0 mm

5x9x1.0 mm, 8x14x1.5 mm, 12x16x1.0 mm, 14x20x1.5 mm, 18x24x1.5 mm, 22x29x1.5 mm, 6x10x1.0 mm, 9x14x1.0 mm, 12x16x1.5 mm, 14x20x2.0 mm, 20x24.5x1.5 mm, 24x29x1.5 mm, 6x12x1.0 mm, 10x14x1.0 mm, 12x18x1.5 mm, 16x20x1.5 mm, 20x24.5x0.8 mm, 24x32x2.0 mm, 8x12x1.0 mm, 10x14x1.5 mm, 13x18x1.0 mm, 16x22x1.5 mm, 19x26x2.0 mm, 26x34x2.0 mm, 8x14x1.0 mm, 10x16x1.0 mm, 14x18x1.5 mm, 18x22x1.5 mm, 22x27x1.0 mm, 28x36x2.0 mm

YATO
YT-06872

5/20

GB Copper gasket & oil drain plug assortment
D Ölablassschraube Kupfer Schrauben und O-Ringe
PL Zestaw podkładek miedzianych i korków spustowych
RUS Набор медных шайб и сливных пробок поддона двигателя

CZ Sada měděných podložek a zátek pro olejové výpustě
H Olajteknő csavar és rézalátét készlet
RO Set busoane baie ulei
F Boulons de carter d'huile & assortiment bagues

I Set di rondelle in rame a spine
E Tornillos y juntas para tapon de carter
CN 534PC;油封

PLASTIC BOX



534
PCS

MIX
SIZE
ROZMIARÓW

Cu



50x 6 mm	50x 8 mm	50x 10 mm	50x 12 mm	50x 13 mm	50x 14 mm
50x 15 mm	50x 16 mm	50x 18 mm	50x 20 mm	5x M8x1	5x M10x1
5x M12x1.5	5x G1/4	5x M14x1.5	3x M16x1.5	3x M18x1.5	3x M20x1.5

6 mm, 8 mm, 10 mm, 12 mm, 13 mm, 14 mm, 15 mm, 16 mm, 18 mm, 20 mm;
M8x1.0, M10x1.0, M12x1.5, M14x1.5, M16x1.5, M18x1.5, M20x1.5; G1/4

YATO
YT-06864

10

GB Bodywork nuts & screws assortment
D Sortiment Karosseriemutter mit Schrauben
PL Zestaw wkrętów i podkładek do karoserii
RUS Набор саморезов и металлических клипс для кузовных работ

CZ Tělo matice a šroub kit
H Karosszeria csavar és anya készlet
RO Set asamblare clema / holsuruburi
F Assortiment de vis et d'écrous cage

I Set viti e rondelle al corpo
E Body kit tornillo
CN 170件套螺丝U型圈组套

PLASTIC HANGING BOX



170
PCS

MIX
SIZE
ROZMIARÓW



M3, M4, M5, M6;

M3x8 mm, M4x16 mm,
M5x12 mm, M6x20 mm

YATO
YT-06780

5/20

GB Metric nuts & bolts assortment
D Metric Mutter und Bolzen Sortiment
PL Zestaw śrub, nakrętek, podkładek i wkrętów

RUS Набор винты / гайки / болты / шайбы
CZ Sada šroubů, matic, podložek
H Csavarkészlet
RO Set suruburi / piulite

F Ecrous et boulons métrique assortment
I Set di viti, dadi, rondelle e viti
E Tuercas y tornillos métrica surtido
CN 347PC机丝自攻

PLASTIC
HANGING BOX



347
PCS

MIX
SIZE
ROZMIARÓW



 32x 3 x 12 mm	 26x 3 x 20 mm	 13x 5 x 24 mm	 43x 2.5 x 12 mm	 32x 3 x 19 mm	 10x 4 x 24 mm
 59x M5	 19x M6	 19x M5 x 25 mm	 24x M5 x 20 mm	 11x M6 x 20 mm	 10x M6
		 49x M5			

3x12 mm, 3x20 mm, 5x24 mm; 2.5x12 mm, 3x19 mm, 4x24 mm;
M5, M6; M5x20 mm, M5x25 mm, M6x20 mm;
M5, M6

YATO
YT-06771 6/24

GB Clevis pin assortment
D Bolzen mit Kopf
PL Zestaw sworzni z łbem i otworem
RUS Набор штифтов с отверстиями под шплинт

CZ Čepy s hlavou
H Csapszeget kit
RO Set bolturi pt. securizare
F Axe de chape

I Set di perni con testa e il foro
E Kit de pasador de horquilla
CN 60PC销柱

PLASTIC
HANGING BOX



60
PCS

MIX
SIZE
ROZMIARÓW

5-12
mm



5x25 mm, 6x25 mm, 6x30 mm, 6x40 mm, 6x45 mm, 6x50 mm,
6x60 mm, 6x65 mm, 8x25 mm, 8x30 mm, 8x40 mm, 8x45 mm,
8x50 mm, 8x60 mm, 8x65 mm, 8x70 mm, 10x25 mm, 10x40 mm,
10x50 mm, 12x40 mm, 12x50 mm

YATO
YT-06786 4/16

GB Grease nipple set
D Schmiernippel
PL Zestaw smarowniczek
RUS Набор масленок

CZ Sady mazacích hlavíc
H Zsírógomb (zsírzófej) készlet
RO Set gresoare metalice
F Set de graisseurs métriques

I Set grasso capezzoli
E Engrasador
CN 件套黄油嘴组套

PLASTIC
HANGING BOX



110
PCS

METRIC
METRYCZNE



 M6x1	 M6x1 45° 5 pcs	 M8x1 10 pcs	 M8x1 90° 5 pcs	 M10x1 90° 5 pcs	 M10x1 10 pcs
 M6x1 90° 60 pcs	 M6x1 45° 5 pcs	 M8x1 45° 5 pcs	 M10x1 45° 5 pcs		

M6x1, M6x1 45°, M6x1 90°, M8x1, M8x1 45°, M8x1 90°, M10x1, M10x1 45°, M10x1 90°

YATO
YT-06888 5/20

GB Aluminium rivet assortment
D Aluminium Blindnieten Sortiment
PL Zestaw aluminiowych nitów zrywalnych

RUS Набор заклепок
CZ Sada hliníkové nyty
H Csőves alumínium szegecsek
RO Set popnitr

F Rivets tubulaires en aluminium
I Set di rivetto alluminio
E Remaches tubulares de aluminio
CN 400件套铆钉组套

PLASTIC HANGING BOX



400
PCS

MIX
SIZE
ROZMÍRŮV

AI



2.4, 3.2, 4.0, 4.8 mm

YATO
YT-36420 5/20

GB Spring assortment
D Schraubenfeder Sortiment
PL Zestaw sprężynek
RUS Набор пружинок оцинкованных

CZ Sada pružin
H Rugó készlet
RO Arcuri tensiune
F Assortiment ressorts

I Set di molle
E Caja surtido de de resortes
CN 件套弹簧组套

PLASTIC HANGING BOX



200
PCS

MIX
SIZE
ROZMÍRŮV



10 pcs 7.0 x 12.5 mm 5.0 x 20.5 mm	6 pcs 9.5 x 16.0 mm 8 pcs 8.0 x 28.5 mm	12 pcs 8.5 x 47.0 mm 8.0 x 44.5 mm	8 pcs 4.5 x 44.5 mm 9.0 x 35.0 mm	10 pcs 5.5 x 38.0 mm
10 pcs 6.5 x 10.0 mm 5.5 x 25.5 mm	12 pcs 9.5 x 19.0 mm	12 pcs 7.0 x 51.0 mm 4.0 x 79.5 mm	10 pcs 7.0 x 38.0 mm	10 pcs 8.5 x 36.5 mm 7.0 x 19.0 mm

YATO
YT-06875 5/20

GB Hitch pin assortment set
D Sortiment Federsplinte
PL Zestaw zawleczek sprężystych
RUS Набор шплинтов с фиксацией

CZ Pružinové závlačky
H Rugós csap
RO Set sigurante securizare
F Assortiment goupilles beta

I Set di spine elastiche
E Pasadores surtido beta
CN 150PC R型销

PLASTIC HANGING BOX



150
PCS

6
SIZES
ROZMÍRŮV



2.4x31 mm, 2x33 mm, 2x40 mm,
2.8x42 mm, 3.5x45 mm, 4x75 mm

YATO
YT-06883 6/24

GB Splint pin assortment
D Splinte Sortiment
PL Zestaw zawleczek prostych
RUS Набор шплинтов

CZ Set závlačky
H Sasszeg készlet
RO Cuie spintecate mici
F Goupilles - goupille fendue

I Set di perni
E Dividir cotter pinos
CN 件套开口销组套

PLASTIC
HANGING BOX



555
PCS

MIX
SIZE
ROZMIARÓW



 1.6x25 mm, 2.4x25 mm, 2.4x38 mm,
3.2x32 mm, 3.2x50 mm, 4.0x64 mm

YATO 
YT-06873  5/10

GB Splint pin assortment
D Splinte Sortiment
PL Zestaw zawleczek prostych
RUS Набор шплинтов

CZ Set závlačky
H Sasszeg készlet
RO Cuie spintecate mici
F Goupilles - goupille fendue

I Set di perni
E Dividir cotter pinos
CN 件套开口销组套

PLASTIC
HANGING BOX



1000
PCS

MIX
SIZE
ROZMIARÓW

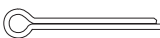

 1.5x25 mm, 2.4x25 mm, 2.4x38 mm,
3.0x32 mm, 3.0x50 mm, 4.0x60 mm

YATO 
YT-06885  12

GB E-ring circlips assortment
D Sortiment E-Sicherungsringe
PL Zestaw zawleczek typu „E”
RUS Набор Э-образных
стопорных колец

CZ Otevření pojistný kroužek
H „E” klip válszték készlet
RO Set inele seger alezaj
F „E” clip assortment kit

I Set di spine tipo „E”
E E-ring anillo
de retención variedad
CN 卡簧

PLASTIC
HANGING BOX



300
PCS

1.5-22
mm



 1.5 mm, 3 mm, 5 mm, 6 mm, 10 mm,
12 mm, 15 mm, 19 mm, 22 mm

YATO 
YT-06884  25

GB Linch-pins assortment
D Klappsplint Sortiment
PL Zestaw zawleczek z kółkiem
RUS Набор шплинтов с кольцом

CZ Kolik pojistny
H Rugos biztosítoszeg keszlet
RO Set pini pt. securizare
F Assortiment goupille clip

I Set di perni dalla ruota
E Pasador clip
CN 50件套弹性销组套

PLASTIC BOX



50
PCS

MIX
SIZE
ROZMIAROW

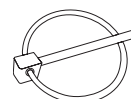

Ø 4.5x36 mm, Ø 6.0x45 mm,
 Ø 8.0x45 mm, Ø 11.0x45 mm

YATO

YT-06787



6/12

GB Hose clamp assortment
D Schlauchschelle Sortiment
PL Zestaw obejm ślimakowych
RUS Набор хомутов

CZ Spony stahovac na hadice sada
H Tömélbilincs csőszerelés szett
RO Coliere furtun
F Colliers de serrage universels

I Fascetta assortmento
E Manguera helicoidal instalación de tuberías abrazadera conjunto
CN 26件套喉箍

PLASTIC HANGING BOX



26
PCS

MIX
SIZE
ROZMIAROW

16-40
mm

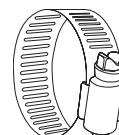

16, 22, 25, 28, 35, 40 mm

YATO

YT-06782



5/20

GB External / internal circlip assortment
D Aussen / Innen seegerring sortiment
PL Zestaw pierścieni Segera wewnętrznych / zewnętrznych
RUS Набор стопорных колец

CZ Sada vnitřní / vnější kroužky
H Állítsa belső / külső seeger-gyűrű
RO Set inele seger arbore
F Externe / interne assortiment de circlip

I Set all'esterno / all'interno degli anelli Segera
E Sortimento freio externo / interno
CN 225件套外挡圈

PLASTIC HANGING BOX



225
PCS

MIX
SIZE
ROZMIAROW

EXTERNAL
ZEWNETRZNE

INTERNAL
WEWNETRZNE



10x Ø 13 mm	15x Ø 13 mm	15x Ø 14 mm	15x Ø 16 mm	15x Ø 19 mm	10x Ø 20 mm
10x Ø 14 mm	15x Ø 18 mm	10x Ø 19 mm	10x Ø 22 mm	10x Ø 25 mm	5x Ø 32 mm
15x Ø 11 mm	10x Ø 20 mm	15x Ø 11 mm	15x Ø 9 mm	15x Ø 8 mm	15x Ø 6 mm

INTERNAL / WEWNĘTRZNE: Ø 11, 13, 14, 16, 19, 20 mm
 EXTERNAL / ZEWNETRZNE: Ø 6, 8, 9, 11, 13, 14, 16, 19, 20, 22, 25, 32 mm

YATO

YT-06882



5/20

- GB** External circlip assortment
D Aussen-seegerring-sortiment
PL Zestaw pierścieni segera zewnętrznych
RUS Кольца стопорные внешние
CZ Sada pojistné kroužky
H Külső seeger-gyűrű készlet

- RO** Set agrafe
F Set de circlips ext.
I Set all'esterno degli anelli Segera
E Anillos seeger para agujeros exteriores
CN 件套外挡圈组套

PLASTIC
HANGING BOX



300
PCS



Ø 3, 4, 5, 6, 8, 9, 11, 12, 13, 14, 15, 19, 20, 22, 25, 26, 28, 32 mm

YATO 	
YT-06880	5/20

- GB** Internal circlip assortment
D Innen-seegerring-sortiment
PL Zestaw pierścieni segera wewnętrznych
RUS Кольца стопорные внутренние
CZ Sada pojistné kroužky
H Belső seeger-gyűrű készlet

- RO** Set agrafe
F Set de circlips int.
I Set all'interno degli anelli Segera
E Anillos seeger para agujeros interiores
CN 件套内挡圈组套

PLASTIC
HANGING BOX



300
PCS



Ø 3, 4, 5, 6, 8, 9, 11, 12, 13, 14, 15, 19, 20, 22, 25, 26, 28, 32 mm

YATO 	
YT-06881	5/20

- GB** Feather keys assortment
D Sortiment Federkeile
PL Zestaw klinów półokrągłych
RUS Шпонки полукруглые

- CZ** Sada klinů polokruhových
H Ives hornyok biztosítására
RO Set pene disc pt. imbinari arbore
F Aspérule clés assortment

- I** Set di cunei semicirculari
E Surtido de chavetas media luna
CN 键销

PLASTIC
HANGING BOX



80
PCS



 3.0x5.0x13 mm, 3.0x6.5x16 mm, 4.0x5.0x13 mm,
4.0x6.5x16 mm, 4.0x7.5x19 mm, 5.0x7.5x19 mm,
5.0x9.0x22 mm, 6.0x9.0x22 mm

YATO 	
YT-06790	25

GB Socket head set screw assortment metric
D Sortiment Madenschrauben, metrisch
PL Zestaw śrub imbusowych bez łba
RUS Набор винтов установочных с плоским концом

CZ Šroub stavěcí, plochý konec, bez úpravy
H Set menetes sasszegekkel
RO Set splituri filetate
F Set clavettes de vis

I Set di viti esagonali senza testa
E Conjunto de tornillo chavetas
CN 160件套无头螺钉组套

PLASTIC HANGING BOX



160 PCS **MIX** SIZE ROZMĚRŮ



3x5 mm, 4x5 mm, 5x6 mm, 6x6 mm, 6x6 mm F, 6x10 mm, 8x10 mm, 8x10 mm F, 8x12 mm, 10x10 mm, 10x10 mm F, 10x12 mm

YATO **YT-06777** 5/20

GB Rubber Grommet Assortment
D Gummi-durchgangs-tullen sortiment
PL Zestaw przelotek gumowych
RUS Набор резиновых втулок

CZ Gumové průchodka
H Gumi grommet készlet
RO Presetupa cauciu pt. cablu
F Coffret passe-cloison caoutchouc

I Gommino angello
E Caja surtido de pasamuros de goma
CN 件套垫圈组套

PLASTIC HANGING BOX



180 PCS **MIX** SIZE ROZMĚRŮ



5 PCS D= 22.0 mm ID= 15.0 mm OD= 28.0 mm	40 PCS D= 9.5 mm ID= 6.0 mm OD= 13.0 mm	5 PCS D= 15.8 mm ID= 12.0 mm OD= 19.0 mm	40 PCS D= 7.9 mm ID= 5.0 mm OD= 10.0 mm	25 PCS 	5 PCS
		40 PCS D= 6.3 mm ID= 3.0 mm OD= 8.0 mm	20 PCS D= 12.7 mm ID= 11.0 mm OD= 15.0 mm	D= 11.0 mm ID= 9.0 mm OD= 15.0 mm	D= 25.4 mm ID= 17.0 mm OD= 32.0 mm

YATO **YT-06778** dimensions / wymiary (mm) 6.3; 7.9; 9.5; 11.0; 12.7; 15.8; 22.0; 25.4 5/20

GB Roll pin assortment
D Hohlspannstifte Spannsteife Sortiment
PL Zestaw kolków sprężystych
RUS Набор штифтов разрезных пружинных цилиндрических

CZ Pružné válcové kolíky se štěrbínou
H Rugalmas hengeres csapok a nyílásba
RO Set splinturi elastice
F Rouleau broche / pin assortiment de printemps

I Perno del rullo assortimento
E Acero pasador elástico
CN 315件套热收缩管组套

PLASTIC HANGING BOX



315 PCS **MIX** SIZE ROZMĚRŮ



1.5x5mm, 1.5x8mm, 1.5x20mm, 2x6mm, 2x12mm, 2x25mm, 2.5x16mm, 2.5x25mm, 2.5x30mm, 3x16mm, 3x25mm, 3x30mm, 4x16mm, 4x25mm, 4x40mm, 5x16mm, 5x25mm, 5x30mm, 5.5x16mm, 5.5x30mm, 5.5x45mm, 6x16mm, 6x30mm, 6x45mm, 8x20mm, 8x40mm, 8x50mm, 10x20mm, 10x40mm, 10x50mm

YATO **YT-06785** 5/20

GB O-ring assortment
D O-ring Sortiment
PL Zestaw O-ringów gumowych
RUS Набор резиновых прокладок

CZ Gumové „o“ kroužky sada
H O gyűrű készlet
RO Garnituri din cauciuc
F Set d'o-rings en caoutchouc

I Set guarnizioni O-ring
E Kit de junta tórica
CN 件套O型圈组套

PLASTIC
HANGING BOX



225
PCS

HEAT RESISTANT
TEMPERATURAOOPORNE

OIL, PETROL,
CHEMICAL
RESISTANT
ODPORNE NA OLEJ,
BENZYNIE,
CHEMICALIA



3x1 mm ○ 20 pcs	4x1 mm ○ 20 pcs	4,5x2 mm ○ 20 pcs	5x2 mm ○ 20 pcs	6x2 mm ○ 20 pcs	6x2,5 mm ○ 20 pcs
13x3 mm ○ 5 pcs	14x2,5 mm ○ 5 pcs	17x2,5 mm ○ 5 pcs	18x4 mm ○ 5 pcs	20x2 mm ○ 5 pcs	22x2 mm ○ 5 pcs
6x3 mm ○ 20 pcs	7x2 mm ○ 20 pcs	8x2 mm ○ 20 pcs	9x2 mm ○ 5 pcs	10x2 mm ○ 5 pcs	12x3 mm ○ 5 pcs

YATO
YT-06877

5/20

GB O-Rings assortment for air conditioning
D O-Ringe für die Klimaanlage
PL Zestaw O-ringów HNBR do klimatyzacji
RUS Набор резиновых прокладок для систем кондиционирования воздуха

CZ Gumový kroužek set klimatizace
H Gumi gyűrű készlet légkondicionáló
RO Inele pt. aer condiționat
F Cercle en caoutchouc boîte de kit combinaison

I O-Ring assortimento per l'aria condizionata
E Kit círculo caucho combinación caja
CN 270PC 绿色O型圈

PLASTIC
HANGING BOX



270
PCS

MIX
SIZE
ROZMIAROW

HNBR
MATERIAL
MATERIAL



20x ∅ 5,29 x 1,78 mm	20x ∅ 6,07 x 1,78 mm	20x ∅ 6,8 x 1,9 mm	20x ∅ 7,65 x 1,78 mm	20x ∅ 7,8 x 1,9 mm	20x ∅ 8 x 2 mm
20x ∅ 8,8 x 1,9 mm	15x ∅ 10,82 x 1,78 mm	15x ∅ 10,77 x 2,62 mm	15x ∅ 11 x 2 mm	15x ∅ 12 x 2 mm	10x ∅ 13,9 x 1,8 mm
10x ∅ 13,95 x 2,62 mm	10x ∅ 10 x 2 mm	10x ∅ 15 x 2 mm	10x ∅ 17 x 2 mm	10x ∅ 17,17 x 1,78 mm	10x ∅ 17,04 x 3,53 mm

∅ 5.29 x 1.78 mm, 6.07 x 1.78 mm, 6.8 x 1.9 mm, 7.65 x 1.78 mm, 7.8 x 1.9 mm, 8 x 2 mm, 8.8 x 1.9 mm, 10.82 x 1.78 mm, 10.77 x 2.62 mm, 11 x 2 mm, 12 x 2 mm, 13.9 x 1.8 mm, 13.95 x 2.62 mm, 10 x 2 mm, 15 x 2 mm, 17 x 2 mm, 17.17 x 1.78 mm, 17.04 x 3.53 mm

YATO
YT-06879

6/24

GB O-ring assortment
D O-ring Sortiment
PL Zestaw O-ringów gumowych
RUS Набор резиновых прокладок

CZ Gumové „o“ kroužky sada
H O gyűrű készlet
RO Garnituri din cauciuc
F Set d'o-rings en caoutchouc

I Set guarnizioni O-ring
E Kit de junta tórica
CN 件套O型圈组套

PLASTIC BOX



419
PCS

MIX
SIZE
ROZMIAROW

NBR
MATERIAL
MATERIAL

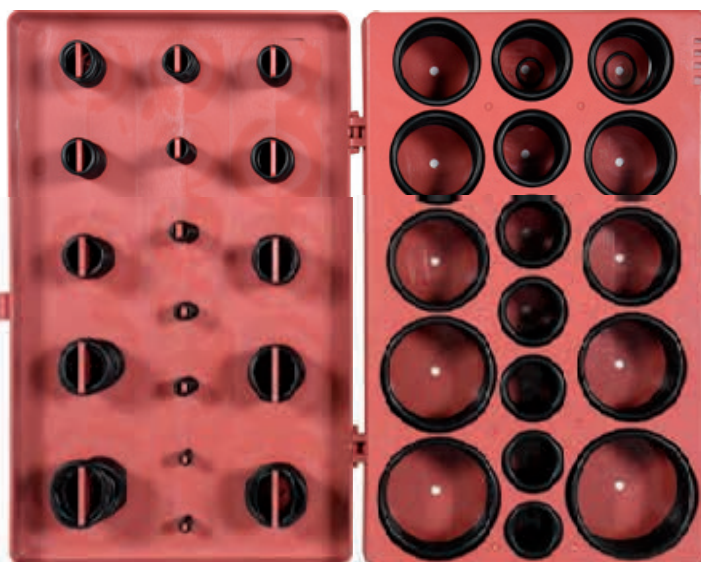

3x1.5 mm, 4.4x2 mm, 5x2 mm, 7x1.5 mm, 10x1.5 mm, 10x2.5 mm, 11x2.5 mm, 13x1.5 mm, 13x2.5 mm, 14x2.5 mm, 16x2.5 mm, 18x2.5 mm, 19x2.5 mm, 21x2.5 mm, 22x2.5 mm, 18x3.5 mm, 20x3.5 mm, 22x3.5 mm, 23.5x3.5 mm, 25x3.5 mm, 26.5x3.5 mm, 28x3.5 mm, 30x3.5 mm, 31x3.5 mm, 33x3.5 mm, 34.5x3.5 mm, 36x3.5 mm, 38x3.5 mm, 41x3.5 mm, 44x3.5 mm, 47x3.5 mm, 50x3.5 mm

YATO
YT-06876

24

- GB** Heat-shrink tubing set
D Schrumpfschlauch - Sortiment
PL Zestaw koszulek termokurczliwych
RUS Набор термоусадочных трубок
- CZ** Smršťovací bužírka tepelné
H Hőre zsugorodó cső szettek
RO Set tuburi termocontractabile
F Gaine thermoretractable coffret

- I** Tubo termoretraibile per isolare
E Surtido tubo de conexión eléctrica cable manga
CN 件套热收缩管

PLASTIC HANGING BOX



127 PCS	MIX SIZE ROZMIARÓW	125°C max.	600 V max.
------------	--------------------------	---------------	---------------



Ø 2.0 x 40, 2.5 x 40, 3.5 x 40, 5.0 x 40, 7.0 x 80, 10.0 x 80, 13.0 x 85 mm

YATO		
YT-06866		5/20

- GB** Terminal connectors
D Kabelschuhe schnellkupplung kabelklemme
PL Zestaw szybkozłączy elektrycznych
- RUS** Набор экспресс-клемм
CZ Kabelova rychlospojka
H Gyors csatlakozó auto
RO Conector rapid pt. auto

- F** Connecteur rapide
I Connettori terminali
E Conector rapido electrico
CN 件套连接片组套

PLASTIC HANGING BOX



50 PCS	MIX SIZE ROZMIARÓW
-----------	--------------------------

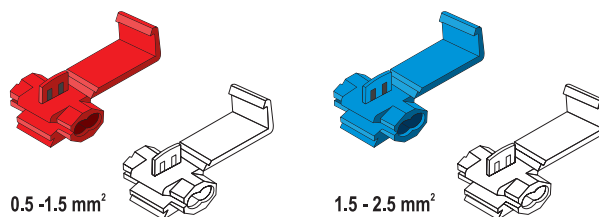

YATO	dimensions / wymiary (mm²)	
YT-06868	0.5 - 1.5; 1.5 - 2.5	5/20

- GB** Electrical clip assortment
D Krokodil-Klemmen-Kortiment
PL Zestaw złączy elektrycznych - krokodylki
RUS Набор разъемов - крокодил

- CZ** Terminal alligator krokodil přichytek
H Krokodil csipesz készlet
RO Sortiment cleme crocodil
F Assortiment pinces crocodile

- I** Set di perni per misure e prove
E Crocodile clip
CN 件套夹头组套

PLASTIC HANGING BOX



28 PCS	MIX SIZE ROZMIARÓW
-----------	--------------------------



10 pcs / sztuk - Alligator - clip without insulation / Krokodylki nieizolowane
 6 pcs / sztuk - Alligator - clip insulation / Krokodylki izolowane
 4 pcs / sztuk - Big charging clip insulation / Zaciski duże izolowane
 6 pcs / sztuk - Mini alligator - clip / Krokodylki małe izolowane
 2 pcs / sztuk - Small charging clip insulation / Zaciski małe izolowane

YATO	dimensions / wymiary (mm)	
YT-06870	50; 55; 60; 65; 70; 80	5/20

Memo

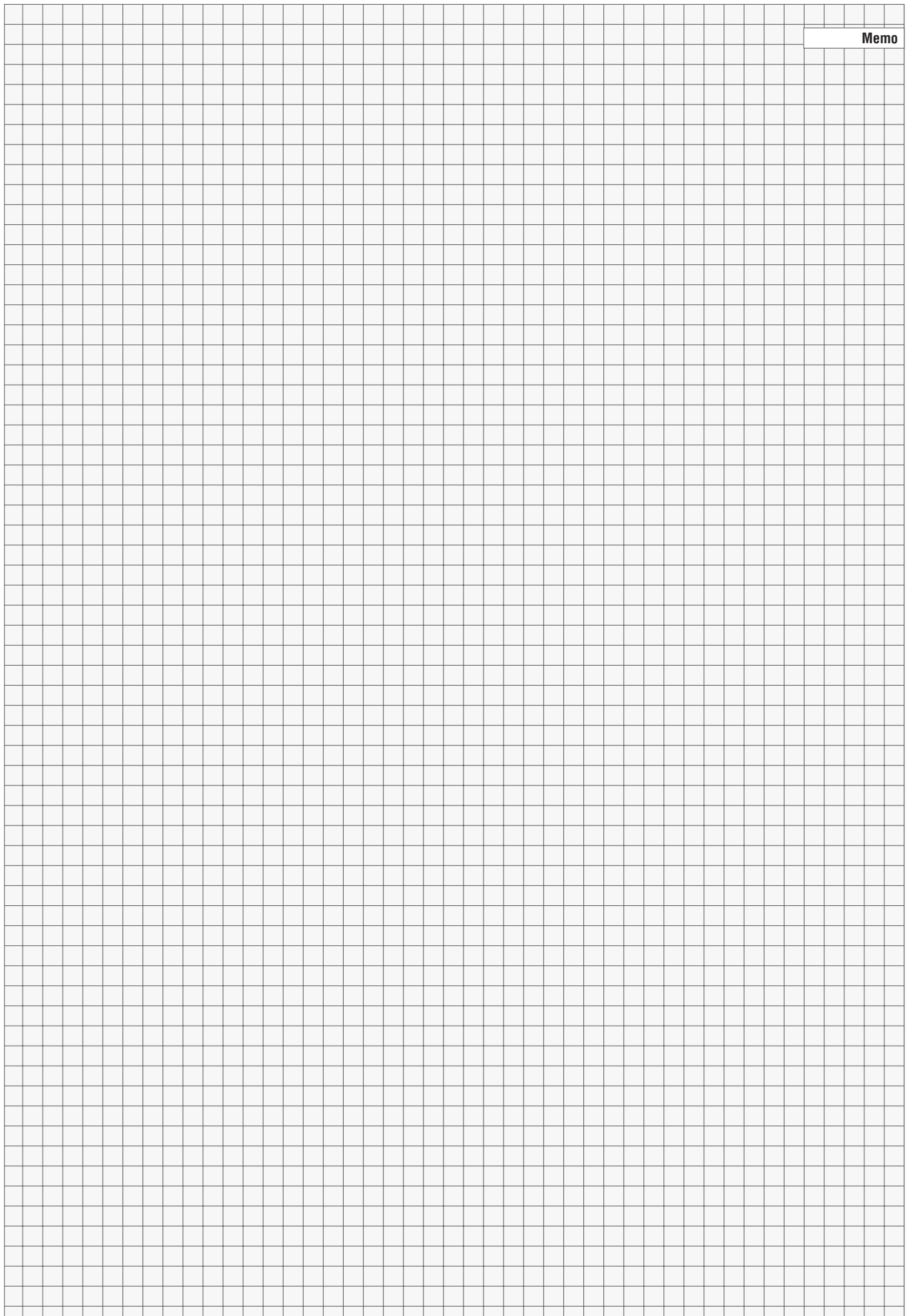

17

Welding equipment & accessories Narzędzia spawalnicze i akcesoria



Welding helmets & accessories
Przyłbice spawalnicze i akcesoria

370



Profile connection & forming pliers
Szcypce do łączenia i kształtowania profili

373



Ball peen hammers & sets
Młotki blacharskie i zestawy

371



Spot weld cutter sets
Zestawy rozwiertaków do zgrzewów

373



Dead blow hammers
Młotki bezodrzutowe

371



Combination edge setters & hole punch pliers
Dziurkarko-felcarki

374



Lock grip pliers
Szcypce zaciskowe

372



Magnetic holders
Wsporniki magnetyczne

374



Self-locking multi grip pliers

Szcypce blacharskie..... 372

Welding locking pliers

Szcypce zaciskowe, spawalnicze..... 372

Flat locking pliers

Szcypce zaciskowe o szerokich szczękach..... 372

C-type welding locking pliers

Szcypce zaciskowe, klamrowe typu „C”..... 372

Chain locking pliers

Szcypce zaciskowe z łańcuchem..... 372

Tin snips

Nożyce do blachy

375-378



GB Auto-darkening welding helmet
D Schweißsmaske, selbstverdunkelnd
PL Przyłbica spawalnicza samościemniająca
RUS Маска для сварки, самостоятельно затемняющаяся
CZ Svářečská kukla samostmívací
H Önmagától sötétedő hegesztőpajzs

RO Mască de sudură auto-întunecare
F Masque de soudage
I Oscuramento casco di saldatura
E Casco auto-oscurecedor para soldadura
CN 工具车双挂板

COLOR BOX



DARK STATE STAN CIEMNY 9-13	LIGHT STATE STAN JASNY 4	REACTION TIME CZAS REAKCJI 1/25000 s	BRIGHTENING TIME CZAS ROZJAŚNIANIA 0,1-1,0 s
FILTER TEST TEST FILTRA		LOW BATTERY ALARM WSKAZNIK POZIOMU BATERII	
2x3V CR2045 BATTERIES NOT INCLUDED *BATERIE NIE SĄ DOŁĄCZONE*		WORKING TEMPERATURE TEMPERATURA PRACY -5°C + +55°C	

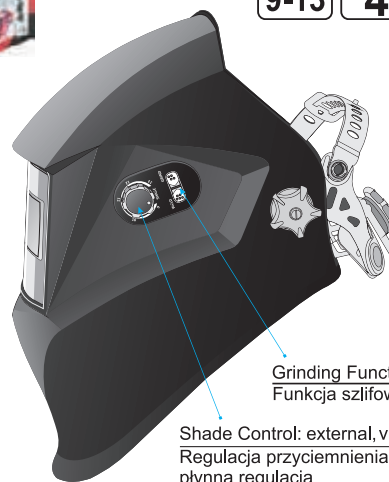

Grinding Function: YES
Funkcja szlifowania: TAK

Shade Control: external, variable
Regulacja przyciemnienia: zewnętrzna, płynna regulacja

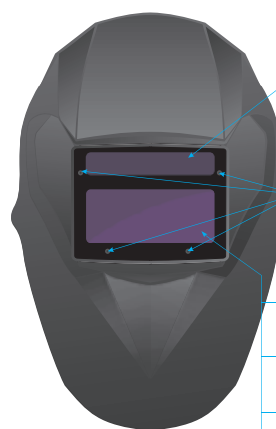

Solar cell filter power supply during welding
Ogniowo słoneczne zasilanie filtra podczas spawania

Arc Sensor: 4
Liczba czujników łuku: 4

Viewing Area: 98x43 mm
Obszar pola widzenia: 98x43 mm

UV/IR Protection
Ochrona przed promieniowaniem UV/IR

Automatic power on / off
Automatyczne włączenie / wyłączenie

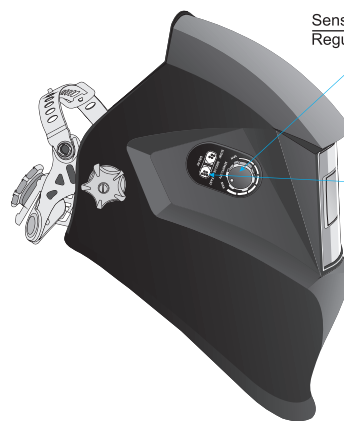

Sensitivity Control
Regulacja czułości

The rate of dimming
Szybkość ściemniania
0.3 - 1.0 ms

- EN 379
- optical class: 1 / 1 / 1 / 1
- cover lens YT-73924 included
- klasa optyczna: 1 / 1 / 1 / 1
- w zestawie szybki ochronne YT-73924

YATO	
YT-73921	6

TYPE FC-11 EN 166:2001 B

5 PCS	123x98 mm	PC
-----------------	---------------------	-----------

for / dla: YT-73921

POLYBAG

YATO	
YT-73924	20/160

4 POINT HEADGEAR
WIĘŻBA 4 PUNKTOWA

Lock into a detent when lifted
Blokada w pozycji podniesionej

3 position slider to adjust the distance from eyes to lens
3 pozycje regulacji odległości od filtra

Regulation at the occipital area
Regulacja pozycji potylicznej

Ratchet with soft rubber grip to adjust size without removing the helmet
Regulacji obwodu za pomocą systemu grzechotkowego

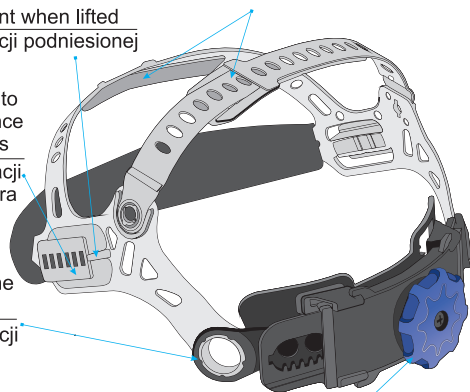

2-point crown strap adjustment to rise or lower the helmet
2 punktowa regulacja wysokości

GB Front cover lens
D Außerschutzglas
PL Szybka ochronna do przyłbicy samościemniającej
RUS Стекло защитное наружное
CZ Přední krycí sklíčko
H Külső védőlemez
RO Protecția exterioră de plastic
F Verres de protection
I Martello per lamiera
E Cubierta de la lente de soldadura
CN 前盖镜片



- GB Auto body fender set
D Karosserie-Ausbeulsatz
PL Komplet młotków blacharskich
RUS Молотки рихтовочные
CZ Souprava klempířských kladívek
H Bádogos kalapács készlet
RO Set de ciocane de tablă
F Set pour carrossier
I Martello per lamiera
E Juego de mazos de hojalatero
CN 钣金工具组套

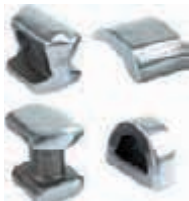

7
PCS

DROP
FORGED
KUTE

GENUINE
HICKORY

BMC
& COLOR
SLEEVE



YATO	m (g)	Box
YT-4590	4900	4

- GB Ball pein hammer
D Ausbeulhammer
PL Młotek blacharski
RUS Молоток рихтовочный
CZ Klempířské kladívko
H Bádogos kalapács
RO Ciocan pt. tabla
F Marteau à panne ronde
I Martello per lamiera
E Martillo de hojalatero
CN 圆头锤



FIBREGLASS
WŁÓKNO
SZKLANE

YATO	m (g)	L (mm)	A (mm)	H (mm)	Box
YT-4515	225	280	26	80	6/36
YT-4516	450	315	34	100	6/24
YT-4518	900	380	40	125	6/12

- GB Ball pein hammer
D Ausbeulhammer
PL Młotek blacharski
RUS Молоток рихтовочный
CZ Klempířské kladívko
H Bádogos kalapács
RO Ciocan pt. tabla
F Marteau à panne ronde
I Martello per lamiera
E Martillo de hojalatero
CN 圆头锤

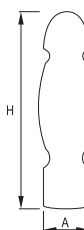

YATO	m (g)	L (mm)	A (mm)	H (mm)	Box
YT-4519	225	295	26	80	6/36
YT-4520	450	335	35	100	6/24
YT-4521	680	360	36	115	6/12
YT-4522	900	380	40	125	6/12

- GB Dead blow mallet
D Rückschlagsfreier
Schonhammer
PL Młotek bezodrzutowy
RUS Молоток безинерционный
CZ Palička nárazová plněná
celogumová
H Visszarúgás mentes
gumikalapács
RO Ciocan cu absorbție
F Maillet sans recul
I Martello morto colpo
E Martillo sin reacción
CN 防震无回弹橡胶锤



PU

YATO	m (g)	L (mm)	Ø (mm)	H (mm)	Box
YT-4624	265	318	30.0	94	10/40
YT-4625	430	350	40.0	100	6/36
YT-4626	490	348	45.0	110	6/36

- GB Dead blow mallet
D Rückschlagsfreier
Schonhammer
PL Młotek bezodrzutowy
RUS Молоток безинерционный
CZ Palička nárazová
plněná celogumová
H Visszarúgás mentes
gumikalapács
RO Ciocan cu absorbție
F Maillet sans recul
I Martello morto colpo
E Martillo sin reacción
CN 防震无回弹橡胶锤



PU



YATO	m (g)	L (mm)	Ø (mm)	H (mm)	Box
YT-4620	740	300	44.5	100.0	4/24
YT-4622	900	336	53.5	100.0	4/24
YT-4623	1300	350	59.0	118.5	3/12

- GB PU & nylon heads mallet
D Schonhammer
mit PU & Nylon-Schlagkopf
PL Młotek blacharski
RUS Молоток рихтовочный
CZ Palička klempířská
H Vaskalapács
RO Ciocan tinichigerie
cap PU / nylon
F Marteau spécial
en PU / nylon
I Martello per lamiera
E Martillo chapista
CN 木柄安装锤



PU

NYLON

YATO	m (g)	L (mm)	Ø (mm)	H (mm)	Box
YT-4630	150	250	22	75	6/48
YT-4631	250	280	28	85	6/36
YT-4632	340	315	35	95	6/36
YT-4633	660	350	45	105	6/24
YT-4634	1340	380	60	132	4/16

GB Self-locking multi grip pliers
D Grip-Festhaltezeuge
PL Szczypce blacharskie
RUS Зажим ручной сварочный для закрепления лент и профилей
CZ Kleště klempířské samodržící
H Őnzáró rógzítófógó

RO Clește autoblocant pt. tinichigerie
F Pince pour tôle
I Pinze per lamiera
E Pinzas de chapa
CN 多功能大力钳



CrMo



200 mm 0-15 mm 70 mm TYPE W

YATO	L (mm)	
YT-2160	200	12/24



230 mm 0-15 mm 45 mm TYPE JJ

YATO	L (mm)	
YT-2161	230	12/24



215 mm 0-10 mm 45 mm TYPE LL

YATO	L (mm)	
YT-2162	215	12/36

GB Welding locking pliers
D Klemmzange zum Schweißen
PL Szczypce zaciskowe spawalnicze
RUS Клещи давяльные сварочные
CZ Kleště samosvorné svářečské
H Hegesztő fogó
RO Clește de strângere pt. sudură

F Pincés de serrage pour soudeur
I Pinze di bloccaggio per saldatura
E Pinzas de tornillo (de apriete) para soldar
CN 焊接用大力钳



225 mm

TYPE U



YATO	L (mm)	
YT-2461	225	6/24

GB Flat locking pliers
D Klemmzange mit breiten Backen
PL Szczypce zaciskowe o szerokich szczękach
RUS Клещи давяльные с широкими губками
CZ Kleště samosvorné se širokými čelistmi
H Lapos fogó

RO Clește de strângere plat / patent
F Pince de serrage large
I Pinze con ganasce piane e palette
E Pinzas de tornillo (de apriete) con mordazas anchas
CN 铁皮大力钳



200 mm

0-12.7 mm

78 mm



YATO	L (mm)	
YT-2463	200	6/24

GB Sliding arm welding locking pliers
D Parallel-gripzange
PL Szybkonastawne szczypce spawalnicze
RUS Образная струбцина с захватом
CZ Paralelné samosvorné kleště
H Szorítórudás őnzáró fogó
RO Clește de mana cu prindere

tip menghina
F Pince-étai - serre-joint coulissant
I Scorrevole pinze di bloccaggio di saldatura braccio
E Pinzas de presión tipo sargento
CN C型滑杆大力钳

260 mm 0-150 mm

QUICK-ADJUSTMENT SZYBKONASTAWNY



YATO	L (mm)	
YT-21570	260	2/16

GB C-type welding locking pliers
D Klemm- und Klammerzange vom Typ „C“
PL Szczypce zaciskowe klamrowe typu „C“
RUS Клещи давяльные типа „С“
CZ Kleště samosvorné upínací typu „C“

H „C“ fogó
RO Clește de strângere cu clemă tip „C“
F Pince de serrage type „C“
I Pinze di bloccaggio tipo „C“
E Pinzas de tornillo (de apriete) de grapa tipo „C“
CN C型大力钳

280 mm

0-100 mm

TYPE C



MOVABLE JAWS RUCHOME SZCZĘKI

YATO	L (mm)	
YT-2466	280	6/24



YATO	L (mm)	
YT-2468	280	6/24

GB Chain locking pliers
D Klemmzange mit Kette
PL Szczypce zaciskowe z łańcuchem
RUS Клещи давяльные с цепью
CZ Kleště samosvorné s řetězem
H Láncos csőfogó
RO Clește de strângere cu lanț
F Pince de serrage avec une chaîne

I Pinze di bloccaggio con la catena
E Pinzas de tornillo (de apriete) con cadena
CN 链条大力钳

500 mm

40 mm

HALF DOUBLE BLISTER



YATO	L (mm)	
YT-2469		6/24

- GB** Profile connection pliers
D Zange zum Verbinden der Profile
PL Szczypce do łączenia profili
RUS Щипцы для соединения профилей
CZ Kleště ke spojování profilů
- H** Profílegyesítő fogó
RO Cleste pt. îmbinarea profilelor
F Pince pour sertir les profiles
I Pinze per la unione profili
E Pinzas para conectar perfiles
CN 龙骨钳



275 mm
A380 AI-Ti ALLOY (HEAD)
GR15 BEARING STEEL (PUNCH)

YATO	L (mm)	
YT-5130	275	6/24



345 mm
65 Mn MATERIAL OF PUNCH PUNKTAK

YATO	L (mm)	
YT-5131	345	6/24

- GB** Profile forming pliers
D Zange zur Formgebung der Profile
PL Szczypce do kształtowania profili
RUS Щипцы для формировки профилей
CZ Kleště k tvarování profilů
- H** Profilformázó fogó
RO Cleste pt. modelarea profilelor
F Pince pour former les profiles
I Pinze per la formazione di profili
E Pinzas para formar perfiles
CN 龙骨钳



80x35 mm JAWS SZCZĘKI

YATO	L (mm)	
YT-5140	210	2/12



80x35 mm JAWS SZCZĘKI

YATO	L (mm)	
YT-5141	210	2/12



150x35 mm JAWS SZCZĘKI

YATO	L (mm)	
YT-5142	210	2/12

- GB** Profile connection pliers
D Zange zum Verbinden der Profile
PL Szczypce do łączenia profili
RUS Щипцы для соединения профилей
CZ Kleště ke spojování profilů
H Profílegyesítő fogó
RO Cleste pt. îmbinarea profilelor
- F** Pince pour sertir les profiles
I Pinze per la unione profili
E Pinzas para conectar perfiles
CN 新款长柄龙骨钳

280 mm
SECTION THICKNESS GRUBOSĆ PROFILI 0.5-0.8 mm



GR15 BEARING STEEL (PUNCH)
A380 AI-Ti ALLOY (HEAD)

SLIDING CARD



YATO	L (mm)	
YT-51311	280	6/24

- GB** Punch pliers
D Blech Lochzange
PL Szczypce do dziurkowania blach
RUS Просекатель круглых отверстий
CZ Děrovací kleště
H Fogó peremező lyukasztó
- RO** Cleste pt. perforat
F Trou pincec feuilles
I Pinza per forare lamiera
E Punzonadora una mano perfiles
CN CS打孔钳

240 mm
PUNCH DIAMETER ŚREDNICA OTWORU Ø 3.2 mm



GR15 BEARING STEEL (PUNCH)

SLIDING CARD



YATO	L (mm)	
YT-51320	240	5/30

- GB** Spot weld cutter & drill bit set
D Schweißpunktbohrer Set
PL Zestaw rozwiertaków do zgrzewów punktowych
RUS Набор для высверливания точечной сварки
CZ Sada na odvrtání bodových svárů
H Hegesztőpont maró készlet
RO Set de freze pt. suduri în puncte
F Jeu de fraises pour points de soudage
I Set di alesatori per punti di saldatura
E Juego de puntos de soldadura de la fresa
CN 点焊刀

9 PCS
Ø 8 mm
10 mm HSS



METAL BOX & COLOR BOX



YATO		
YT-28920		10/60

- GB** Drill welding points set
D Schweißpunkt-Fräasersatz
PL Zestaw wiertel do zgrzewów punktowych
RUS Набор сверл для точечной сварки
CZ Frézy pro bodové sváry
H Pont hegesztés lefűró készlet
RO Set burghiu puncte sudura
F Forets à dépointer les points soudure
I Set di alesatori per punti di saldatura
E Juego de brocas para puntos de soldadura
CN 3件套电焊

3 PCS
COBALT COATED
POKRYTE KOBALTEM
METAL BOX & COLOR BOX



YATO	Ø (mm)	
YT-28921	6.5; 8.0; 10.0	50

GB Combination edge setter / hole punch pliers
D Kombinierte Absetzzange Lochzange
PL Dziurkarko-felcarka
RUS Дырокол, кромкогиб
CZ Falcovačka a děrovačka
H Lyukasztó peremező fogó
RO Cleste pt. fasonat si gaurit tabla

F Pince spéciale perforatrice carrosserie
I Combinazione: bordo setter / pinza perforare
E Solapadora y ponchadora manual
CN 点焊刀

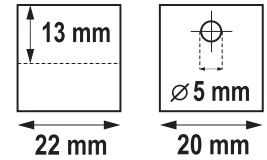

HANGING COLOR BOX

YATO	
YT-21582	10

GB Adjustable angle welding magnet
D Verstellbarer Magnet-Werkstückhalter
PL Wspornik magnetyczny spawalniczy regulowany
RUS Регулируемый магнит заварки угла
CZ Polohovací magnetický držák ke svařování
H Állítható, mágneses, hegesztő támasz
RO Dispozitiv magnetic reglabil pt. sudura
F Support magnétique de soudure
I Supporto della saldatura magnetico
E Soporte magnético de soldadura, ajustable
CN 焊接磁铁



DOUBLE BLISTER

YATO		(kg)	mm	
YT-0862	2x22.5		85x65x22	6

GB Magnetic welding holder
D Magnet-Werkstückhalter
PL Kałownik magnetyczny spawalniczy
RUS Магнитная струбцина заварки

CZ Magnetický uhelník ke svařování
H Mágneses, hegesztő szögvas
RO Dispozitiv magnetic fixare pt. sudura
F Support magnétique de soudure

I Angolo magnetico da saldatura
E Escuadra magnética de soldadura
CN 焊接磁铁

DOUBLE BLISTER

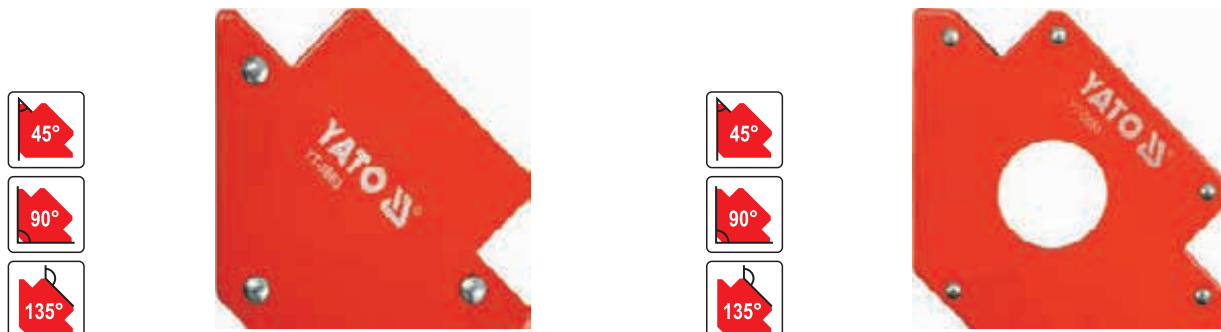

YATO		(kg)	mm	
YT-0863	11.5		82x120x13	6/48

YATO		(kg)	Ø (mm)	mm	
YT-0864	22.5		18	102x155x17	6/30
YT-0865	34.0		46	122x190x25	6/18

GB Magnetic welding holder
D Magnet-Werkstückhalter
PL Kałownik magnetyczny spawalniczy
RUS Магнитная струбцина заварки
CZ Magnetický uhelník ke svařování
H Mágneses, hegesztő szögvas

RO Dispozitiv magnetic fixare pt. sudura
F Support magnétique de soudure
I Triangolo magnetico da saldatura con interruttore
E Escuadra magnética de soldadura
CN 焊接磁铁

GB Magnetic welding holder with switch
D Magnet-Werkstückhalter mit Schalter
PL Kałownik magnetyczny spawalniczy z wyłącznikiem
RUS Магнитный держатель заварки с выключателем
CZ Magnetický uhelník ke svařování s vypínačem
H Mágneses, hegesztő szögvas, kapcsolóval

RO Dispozitiv magnetic fixare pt. sudura cu intreruptor
F Support magnétique de soudure
I Triangolo magnetico da saldatura con interruttore
E Escuadra magnética de soldadura, con interruptor
CN 焊接磁铁



YATO		(kg)	mm	
YT-0866	11.5		64x95x14	6/24
YT-0867	34.0		111x136x24	6/18



YATO		(kg)	mm	
YT-0870	13.5		107x160x26	6/24

GB Tin snips
D Blehschere
PL Nożyce do cięcia blachy

RUS Ножницы по металлу
CZ Nůžky na plech
H Lemezvágo olló

RO Foarfece pt. tablă
F Cisaille à tôle
I Cesoie per lamiere

E Tijeras para chapas
CN 铁皮剪

SLIDING CARD



LEFT CUT
CIECIE LEWE

CrMo

INCREASED CUTTING POWER
ZWIĘKSZONA SIŁA CIĘCIA

HRC 60-62

DIN 6438



HRC 60-62

DIN 6438



YATO	L (mm)	cutting length (mm)	cutting capacities (mm)				
			copper	cold-rolled steel	hard steel HRC35	stainless steel 304	
YT-1910	260	35	1.80	1.50	1.00	0.90	6/36

YATO	L (mm)	cutting length (mm)	cutting capacities (mm)				
			copper	cold-rolled steel	hard steel HRC35	stainless steel 304	
YT-1915	235	30	1.50	1.20	1.00	0.70	6/36

HRC 60-62

DIN 6438



HRC 56-62

SERRATED EDGES
ZABKOWANA KRAWĘDZ OSTRZY

HIGH FREQUENCY HARDENING
HARTOWANIE IMPULSOWE



YATO	L (mm)	cutting length (mm)	cutting capacities (mm)				
			copper	cold-rolled steel	hard steel HRC35	stainless steel 304	
YT-1918	260	32	1.80	1.50	1.00	0.90	6/36

YATO	L (mm)	cutting length (mm)	cutting capacities (mm)				
			copper	cold-rolled steel	hard steel HRC35	stainless steel 304	
YT-1960	250	40	2.00	1.50	1.00	0.80	6/36

GB Tin snips
D Blehschere
PL Nożyce do cięcia blachy
RUS Ножницы по металлу
CZ Nůžky na plech
H Lemezvágo olló
RO Foarfece pt. tablă
F Cisaille à tôle
I Cesoie per lamiere
E Tijeras para chapas
CN 铁皮剪



LEFT CUT
CIECIE LEWE

HRC 60-62

CrMo

90°

SERRATED EDGES
ZABKOWANA KRAWĘDZ OSTRZY

SLIDING CARD



YATO	L (mm)	cutting length (mm)	cutting capacities (mm)				
			copper	cold-rolled steel	hard steel HRC35	stainless steel 304	
YT-1913	225	30	0.78	0.53	0.46	0.36	6/36

GB Tin snips
D Blehschere
PL Nożyce do cięcia blachy

RUS Ножницы по металлу
CZ Nůžky na plech
H Lemezvágo olló

RO Foarfece pt. tablă
F Cisaille à tôle
I Cesoie per lamiere

E Tijeras para chapas
CN 铁皮剪

SLIDING CARD



STRAIGHT CUT
CIECIE PROSTE

CrMo

INCREASED CUTTING POWER
ZWIĘKSZONA SIŁA CIĘCIA

HRC 60-62

DIN 6438



HRC 60-62

DIN 6438



YATO	L (mm)	cutting length (mm)	cutting capacities (mm)				
			copper	cold-rolled steel	hard steel HRC35	stainless steel 304	
YT-1912	260	35	1.80	1.50	1.00	0.90	6/36

YATO	L (mm)	cutting length (mm)	cutting capacities (mm)				
			copper	cold-rolled steel	hard steel HRC35	stainless steel 304	
YT-1922	290	75	1.10	0.94	0.70	0.53	6/36

HRC 60-62

DIN 6438



HRC 56-62

SERRATED EDGES
ZABKOWANA KRAWĘDZ OSTRZY

HIGH FREQUENCY HARDENING
HARTOWANIE IMPULSOWE



YATO	L (mm)	cutting length (mm)	cutting capacities (mm)				
			copper	cold-rolled steel	hard steel HRC35	stainless steel 304	
YT-1923	230	25	2.00	1.60	1.20	1.20	6/36

YATO	L (mm)	cutting length (mm)	cutting capacities (mm)				
			copper	cold-rolled steel	hard steel HRC35	stainless steel 304	
YT-1962	250	45	2.00	1.50	1.00	0.80	6/36

GB Tin snips
D Blechscherer
PL Nożyce do cięcia blachy

RUS Ножницы по металлу
CZ Nůžky na plech
H Lemezvágo olló

RO Foarfece pt. tablă
F Cisaille à tôle
I Cesioie per lamiera

E Tijeras para chapas
CN 铁皮剪

SLIDING
CARD



RIGHT CUT
CIECIE PRAWO

CrMo

INCREASED CUTTING POWER
ZWIĘKSZONA SIŁA CIĘCIA

HRC 60-62

DIN 6438



HRC 60-62

DIN 6438



YATO	L (mm)	cutting length (mm)	cutting capacities (mm)				6/36
			copper	cold-rolled steel	hard steel HRC35	stainless steel 304	
YAT-1911	260	35	1.80	1.50	1.00	0.90	6/36

YATO	L (mm)	cutting length (mm)	cutting capacities (mm)				6/36
			copper	cold-rolled steel	hard steel HRC35	stainless steel 304	
YAT-1916	235	30	1.50	1.20	1.00	0.70	6/36

HRC 60-62

DIN 6438



HRC 56-62

SERRATED EDGES
ZABKOWANA KRAWĘDZ OSTRZY
HIGH FREQUENCY HARDENING
HARTOWANIE IMPULSOWE



YATO	L (mm)	cutting length (mm)	cutting capacities (mm)				6/36
			copper	cold-rolled steel	hard steel HRC35	stainless steel 304	
YAT-1919	260	32	1.80	1.50	1.00	0.90	6/36

YATO	L (mm)	cutting length (mm)	cutting capacities (mm)				6/36
			copper	cold-rolled steel	hard steel HRC35	stainless steel 304	
YAT-1961	250	40	2.00	1.50	1.00	0.80	6/36

GB Tin snips
D Blechscherer
PL Nożyce do cięcia blachy
RUS Ножницы по металлу
CZ Nůžky na plech
H Lemezvágo olló
RO Foarfece pt. tablă
F Cisaille à tôle
I Cesioie per lamiera
E Tijeras para chapas
CN 铁皮剪



RIGHT CUT
CIECIE PRAWO

HRC 60-62

90°

SERRATED EDGES
ZABKOWANA KRAWĘDZ OSTRZY

SLIDING
CARD



YATO	L (mm)	cutting length (mm)	cutting capacities (mm)				6/36
			copper	cold-rolled steel	hard steel HRC35	stainless steel 304	
YAT-1914	225	30	0.78	0.53	0.46	0.36	6/36

GB Tin snips
D Blechscherer
PL Nożyce do cięcia blachy
RUS Ножницы по металлу
CZ Nůžky na plech
H Lemezvágo olló
RO Foarfece pt. tablă
F Cisaille à tôle
I Cesioie per lamiera
E Tijeras para chapas
CN 铁皮剪



SLIDING
CARD



LEFT CUT
CIECIE LEWE

DROP FORGED
KUTE

HRC 58-61

YATO	L (mm)	cutting length (mm)	cutting capacities (mm)				6/24
			copper	cold-rolled steel	hard steel HRC35	stainless steel 304	
YAT-1900	260	30	0.94	0.78	0.60	0.45	6/24

GB Tin snips
D Blechscherer
PL Nożyce do cięcia blachy
RUS Ножницы по металлу
CZ Nůžky na plech
H Lemezvágo olló

RO Foarfece pt. tablă
F Cisaille à tôle
I Cesioie per lamiera
E Tijeras para chapas
CN 铁皮剪

SLIDING
CARD



RIGHT CUT
CIECIE PRAWO

DROP FORGED
KUTE

HRC 58-61



YATO	L (mm)	cutting length (mm)	cutting capacities (mm)				6/24
			copper	cold-rolled steel	hard steel HRC35	stainless steel 304	
YAT-1901	260	30	0.94	0.78	0.60	0.45	6/24

YATO	L (mm)	cutting length (mm)	cutting capacities (mm)				6/24
			copper	cold-rolled steel	hard steel HRC35	stainless steel 304	
YAT-1902	300	50	0.94	0.78	0.60	0.45	6/24

- GB Tin snips
D Blechschere
PL Nożyce do cięcia blachy
RUS Ножницы по металлу
CZ Nůžky na plech
H Lemezvágó olló
- RO Foarfece pt. tablă
F Cisaille à tôle
I Cesioia per lamiera
E Tijeras para chapas
CN 铁皮剪

SLIDING CARD



For cutting straight and tight curves left or right



STRAIGHT CUT
CIECIE
PROSTE

HRC 58-61

DROP FORGED
KUTE

YATO	L (mm)	cutting length (mm)	cutting capacities (mm)				box
			copper	cold-rolled steel	hard steel HRC35	stainless steel 304	
YT-1925	225	52	0.94	0.78	0.60	0.45	6/36



HRC 58-60

YATO	L (mm)	cutting length (mm)	cutting capacities (mm)				box
			copper	cold-rolled steel	hard steel HRC35	stainless steel 304	
YT-1920	260	42	1.20	1.00	0.60	0.50	6/36

- GB Tin snips
D Blechschere
PL Nożyce do cięcia blachy
RUS Ножницы по металлу
CZ Nůžky na plech
H Lemezvágó olló
- RO Foarfece pt. tablă
F Cisaille à tôle
I Cesioia per lamiera
E Tijeras para chapas
CN 铁皮剪

SLIDING CARD



For cutting straight and tight curves left or right



HRC 58-61

YATO	L (mm)	cutting length (mm)	cutting capacities (mm)				box
			copper	cold-rolled steel	hard steel HRC35	stainless steel 304	
YT-1924	254	52	0.94	0.78	0.60	0.45	6/36

- GB Metal sheet nibbler
D Blechnibbler
PL Nożyce matrycowe do blachy
RUS Ножницы для резки жести
CZ Nůžky na plech
H Lemezvágó olló
- RO Foarfece pt. tablă
F Grignoteuse a tole
I Cesioia roditrice per lamiera
E Tijeras para chapas
CN 法式剪

260 mm

1 mm METAL PLATE BLACHA

1.2 mm ALUMINIUM COOPER ALUMINIUM MEZ

2 mm PLASTIC PLASTIK

Mn 65

3 mm CHANGEABLE CUTTING BLADES WYMIENNE OSTRZA



HALF DOUBLE BLISTER



for / dla:
YT-19260

YATO	L (mm)	box
YT-19260	260	6/36

- GB Tin snips
D Blechschere
PL Nożyce do cięcia blachy
RUS Ножницы по металлу
CZ Nůžky na plech
H Lemezvágó olló
RO Foarfece pt. tablă
F Cisaille à tôle
I Cesioia per lamiera
E Tijeras para chapas
CN 铁皮剪

SLIDING CARD



S55C DROP FORGED STEEL STAL KUTA NA ZMNO

HRC 55-60

HIGH FREQUENCY HARDENING HARTOWANIE IMPULSOWE



YATO	L (mm)	cutting length (mm)	cutting capacities (mm)				box
			copper	cold-rolled steel	hard steel HRC35	stainless steel 304	
YT-1963	200	40	1.5	1.0	0.6	0.6	6/36
YT-1964	250	60	1.8	1.2	0.8	0.8	6/24
YT-1965	300	75	2.0	1.4	0.8	0.8	6/12

- GB Tin snips
D Blechschere
PL Nożyce do cięcia blachy
RUS Ножницы по металлу
CZ Nůžky na plech
H Lemezvágó olló
RO Foarfece pt. tablă
F Cisaille à tôle
I Cesioia per lamiera
E Tijeras para chapas
CN 铁皮剪

SLIDING CARD



S55C DROP FORGED STEEL STAL KUTA NA ZMNO

HRC 55-60

HIGH FREQUENCY HARDENING HARTOWANIE IMPULSOWE



YATO	L (mm)	cutting length (mm)	cutting capacities (mm)				box
			copper	cold-rolled steel	hard steel HRC35	stainless steel 304	
YT-1970	260	42	2.0	1.4	1.0	1.0	6/36

- GB Spare blades for metal sheet nibbler
D Abbrechklängen für Blechnibbler
PL Ostrza zapasowe do nożyc matrycowych
RUS Лезвия для ножиц для резки жести
CZ Ostrů nahradní
H Tartalékpenge

- RO Lame de rezervă
F Lame sécables pour grignoteuse a tole
I Lame di ricambio per cesioia roditrice per lamiera
E Cuchillas de cambio
CN 法式剪备用刀片

3 PCS

Mn 65

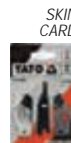

for / dla:
YT-19260

YATO	box
YT-19261	10/100

- GB Steel strap cutter
- D Stahlgurtblechscher
- PL Nożyce do cięcia taśmy stalowej
- RUS Ножницы для резки стальной ленты
- CZ Nůžky na plech
- H Lemezvágó olló
- RO Foarfece pt. tablă
- F Cisaille à bande acier
- I Cesioia per taglio reggetta in acciaio
- E Tijeras para bandejas de acero
- CN 钢带剪

HRC
58-61

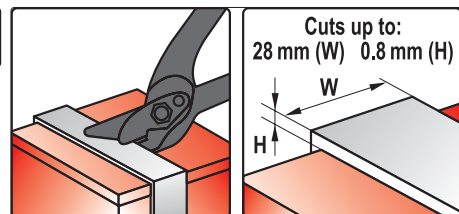

SLIDING
CARD

YATO	L (mm)	cutting length (mm)	cutting capacities (mm)				6/24
			copper	cold-rolled steel	hard steel HRC35	stainless steel 304	
YT-1930	305	28	-	1.00	0.80	0.60	

- GB Portable notchers
- D Schere zum Ausschneiden von Ecken
- PL Nożyce do wycinania naroży
- RUS Ножницы для наружных углов
- CZ Nůžky na vystřihování rohů
- H Sarokkivágó olló
- RO Foarfece pt. taierea colturilor
- F Ciseaux pour le coupage des coins
- I Cesioia per taglio reggetta in angoli
- E Tijera para esquinas
- CN 截角器

300 mm 90°

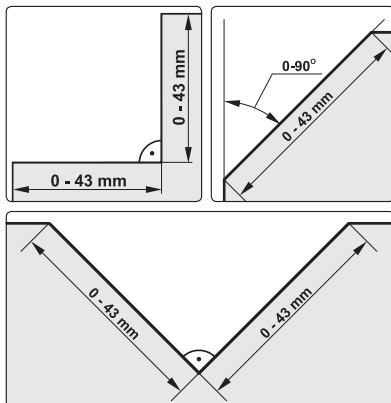

COLOR
BOX

YATO	L (mm)	15
YT-1939	300	

- GB Straight pliers
- D Zange zum Blechbiegen
- PL Kleszcze do gięcia blach
- RUS Клещи с тупым ножом для жести
- CZ Kleště na ohýbání plechu
- H Falctfogó
- RO Cleste pt. indoirea tablei
- F Pince à fléchir la tôle
- I Taglie per la lamiera
- E Tenazas para doblar hojalata
- CN 钣金钳

COLOR
BOX



45° 55 mm

90° 55 mm

180° 55 mm

YATO	L (mm)	10/20
YT-5416	280	

YATO	L (mm)	10/20
YT-5417	260	

YATO	L (mm)	10/20
YT-5415	280	

Memo

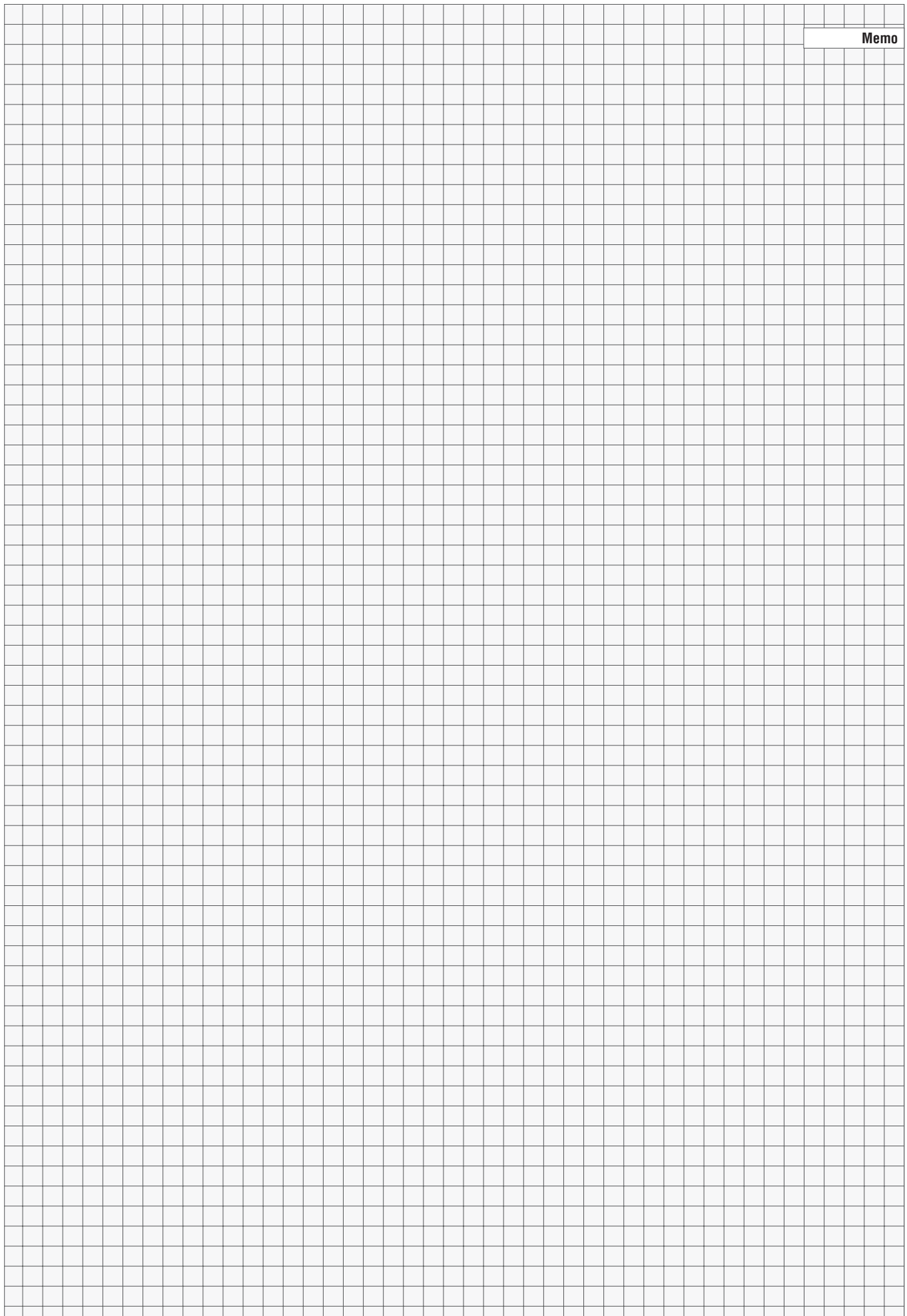

18

**Power & gasoline tools
Elektronarzędzia
i narzędzia spalinowe**



Cordless tools Narzędzia akumulatorowe 383-392 	Knives Noże 399 
Angle grinders Szlifierki kątowe 393 	Hot air guns Opalarki 399-400 
Car polishers Polerki samochodowe 393 	Burners & soldering tools Palniki i lutownice 400-402 
Cut-off machines Przecinarki do metalu 394 	Glue guns Pistolety do klejenia 402 
Drilling machines Wiertarki 394-395 	Pipe welders Zgrzewarki do rur 402 
Drywall screwdrivers Wkrętarki do regipsów 395 	Generators Generatory 403 
Rotary hammers Młotowiertarki 395-396 	Pumps Pompy 403-404 
Circular saws Pilarki tarczowe 396 	Cordless garden tools & accessories Ogrodowe narzędzia akumulatorowe i akcesoria 404-407 
Miter saws Ukośnice 397 	Cordless chainsaws Akumulatorowe pilarki łańcuchowe..... 404 Cordless grass trimmers Akumulatorowe wykaszarki..... 405 Cordless hedge trimmers Akumulatorowe nożyce do żywopłotu..... 406
Jig saws Wyrzynarki 397 	Electric garden tools Ogrodowe narzędzia elektryczne 408 
Planers Strugi 397 	Electric chainsaws Elektryczne pilarki łańcuchowe..... 408
Sabre saws Piły szablaste 397 	Gasoline garden tools & accessories Ogrodowe narzędzia spalinowe i akcesoria 408-414 
Finishing sanders Szlifierki oscylacyjne 398 	Gasoline sprayers Opryskiwacze spalinowe..... 408 Gasoline chainsaws Pilarki spalinowe..... 408 Gasoline brushcutters Kosy spalinowe..... 409 Gasoline hedge trimmers Spalinowe nożyce do żywopłotu..... 409
Drywall sanders Szlifierki do gładzi i tynków 398 	Accessories Akcesoria..... 410
Multi-purpose oscillating tools Wielofunkcyjne narzędzia oscylacyjne 398-399 	Electric hoists Elektryczne wciągarki linowe 414 

A POWERFUL OFFER MOCNA OFERTA

18V Li-Ion!

ONE BATTERY – LOTS OF POSSIBILITIES JEDNA BATERIA – WIELE MOŻLIWOŚCI

The 18 V system means power, freedom and savings!

This series of YATO cordless tools is powered by the same type of heavy-duty 18 V battery and thanks to their extensive selection you can equip a professional workshop, as well as take care of your home and garden.

Each device is available in two versions: in a set with a battery and quick charger or solo, which is a perfect solution if you are expanding your collection of tools powered by the same battery.

Wherever you are, the 18 V battery allows you to work with complete freedom!

System 18 V to moc, swoboda i oszczędność!

Seria narzędzi akumulatorowych YATO zasilana jest tą samą wytrzymałą baterią 18 V, a ich szeroki wybór sprawia, że możesz wyposażyć profesjonalny warsztat, zadbać o dom i ogród.

Każde narzędzie dostępne jest w dwóch wersjach: w zestawie z akumulatorem i szybką ładowarką oraz solo, co jest idealnym rozwiązaniem, gdy powiększasz swoją serię urządzeń działających na wspólnej baterii.

Gdziekolwiek jesteś, z baterią 18 V pracujesz z pełną swobodą!



GB Cordless drill / driver
D Akkuschauber-und-bohrer
PL Akumulatorowa wiertarko-wkrętarka
RUS Аккумуляторная дрель с шурупвертом
CZ Akumulátorový vrtací šroubovák
H Akkus fűrcsavarozók
RO Mașina de găurit / înșurubat cu acumulator
F Perceuse-visseuse sans-fil
I Trapano avvitatore a batteria
E Taladro / atornillador a batería
CN 充电式电钻

18 V Li-Ion 40 Nm 0-440 min⁻¹ 0-1650 min⁻¹ 2.0 Ah 1h QUICK CHARGING SYSTEM ŁADOWANIE 13mm



18V Li-Ion

YATO	V	
YT-82780	18	5

COLOR BOX

GB Cordless drill / driver (tool only)
D Akkuschauber-und-bohrer (nur das Gerät)
PL Akumulatorowa wiertarko-wkrętarka (tylko narzędzie)
RUS Аккумуляторная дрель с шурупвертом (только инструмент)
CZ Akumulátorový vrtací šroubovák (pouze nářadí)
H Akkus fűrcsavarozók (csak a szerszámot)
RO Mașina de găurit / înșurubat cu acumulator (numai sculă)
F Perceuse-visseuse sans-fil (outil seulement)
I Trapano avvitatore a batteria (solo utensile)
E Taladro / atornillador a batería (herramienta solamente)
CN 充电式电钻

18 V Li-Ion 40 Nm 0-440 min⁻¹ 0-1650 min⁻¹ 1h* QUICK CHARGING SYSTEM ŁADOWANIE 13mm



18V Li-Ion

* given charging time is for 2.0 Ah battery only

* podany czas ładowania dotyczy tylko akumulatora 2.0 Ah

battery not included
akumulatora nie dołączono

YATO	V	
YT-82781	18	5

COLOR BOX

GB Cordless drill / driver
D Akkuschauber-und-bohrer
PL Akumulatorowa wiertarko-wkrętarka
RUS Аккумуляторная дрель с шурупвертом
CZ Akumulátorový vrtací šroubovák
H Akkus fűrcsavarozók
RO Mașina de găurit / înșurubat cu acumulator
F Perceuse-visseuse sans-fil
I Trapano avvitatore a batteria
E Taladro / atornillador a batería
CN 充电式电钻

18 V Li-Ion 40 Nm 0-440 min⁻¹ 0-1650 min⁻¹ 2.0 Ah 1h QUICK CHARGING SYSTEM ŁADOWANIE 13mm



18V Li-Ion

YATO	V	
YT-82782	18	4

BMC & COLOR SLEEVE

GB Cordless drill / driver (tool only)
D Akkuschauber-und-bohrer (nur das Gerät)
PL Akumulatorowa wiertarko-wkrętarka (tylko narzędzie)
RUS Аккумуляторная дрель с шурупвертом (только инструмент)
CZ Akumulátorový vrtací šroubovák (pouze nářadí)
H Akkus fűrcsavarozók (csak a szerszámot)
RO Mașina de găurit / înșurubat cu acumulator (numai sculă)
F Perceuse-visseuse sans-fil (outil seulement)
I Trapano avvitatore a batteria (solo utensile)
E Taladro / atornillador a batería (herramienta solamente)
CN 充电式电钻

18 V Li-Ion 40 Nm 0-440 min⁻¹ 0-1650 min⁻¹ 1h* QUICK CHARGING SYSTEM ŁADOWANIE 13mm



18V Li-Ion

* given charging time is for 2.0 Ah battery only

* podany czas ładowania dotyczy tylko akumulatora 2.0 Ah

battery not included
akumulatora nie dołączono

YATO	V	
YT-82783	18	5

COLOR BOX

- GB Cordless impact drill / driver
- D Akku-Schlagbohrschrauber
- PL Akumulatorowa wiertarko-wkrętarka udarowa
- RUS Аккумуляторный ударный дрель-шуруповерт
- CZ Akumulátorový nárazový šroubovák s příklepem
- H Akkus ütvefűrógép
- RO Mașina de găurit cu percucie cu accumulator
- F Perceuse-visseuse percussion sans-fil
- I Trapano avvitatore a percussione a batteria
- E Taladro / atornillador con percusión a batería
- CN 充电式冲击钻

18 V	Li-Ion	40 Nm	0-440 min ⁻¹ 0-1650 min ⁻¹	T 0-7920 min ⁻¹ 0-29700 min ⁻¹
2.0 Ah	1h QUICK CHARGING SYSTEME SZYBIE ŁADOWANIE	13mm		



$L_{pA} = 82.0 \pm 3.0$ dB;
 $L_{wA} = 93.0 \pm 3.0$ dB;
 $a_{a0} = 3.0 \pm 1.5 / 9.89 \pm 1.5$ m/s²

COLOR BOX

YATO	V	
YT-82786	18	5

- GB Cordless impact drill / driver (tool only)
- D Akku-Schlagbohrschrauber (nur das Gerät)
- PL Akumulatorowa wiertarko-wkrętarka udarowa (tylko narzędzie)
- RUS Аккумуляторная ударный дрель-шуруповерт (только инструмент)
- CZ Akumulátorový nárazový šroubovák s příklepem (pouze nářadí)
- H Akkus ütvefűrógép (csak a szerszámot)
- RO Mașină de găurit cu percucie cu accumulator (numai sculă)
- F Perceuse-visseuse percussion sans-fil (outil seulement)
- I Trapano avvitatore a percussione a batteria (solo utensile)
- E Taladro / atornillador con percusión a batería (herramienta solamente)
- CN 充电式冲击钻 (光机)

18 V	Li-Ion	40 Nm	0-440 min ⁻¹ 0-1650 min ⁻¹	T 0-7920 min ⁻¹ 0-29700 min ⁻¹
1h*	QUICK CHARGING SYSTEME SZYBIE ŁADOWANIE	13mm		



* given charging time is for 2.0 Ah battery only

$L_{pA} = 82.0 \pm 3.0$ dB;
 $L_{wA} = 93.0 \pm 3.0$ dB;
 $a_{a0} = 3.0 \pm 1.5 / 9.89 \pm 1.5$ m/s²

battery not included
akumulatora nie dołączono

YATO	V	
YT-82787	18	5

- GB Cordless impact drill / driver
- D Akku-Schlagbohrschrauber
- PL Akumulatorowa wiertarko-wkrętarka udarowa
- RUS Аккумуляторный ударный дрель-шуруповерт
- CZ Akumulátorový nárazový šroubovák s příklepem
- H Akkus ütvefűrógép
- RO Mașina de găurit cu percucie cu accumulator
- F Perceuse-visseuse percussion sans-fil
- I Trapano avvitatore a percussione a batteria
- E Taladro / atornillador con percusión a batería
- CN 充电式冲击钻

18 V	Li-Ion	40 Nm	0-440 min ⁻¹ 0-1650 min ⁻¹	T 0-7920 min ⁻¹ 0-29700 min ⁻¹
2.0 Ah	1h QUICK CHARGING SYSTEME SZYBIE ŁADOWANIE	13mm		



$L_{pA} = 71.0 \pm 3.0$ dB;
 $L_{wA} = 82.0 \pm 3.0$ dB;
 $a_{a0} = 3.0 \pm 1.5 / 9.89 \pm 1.5$ m/s²

BMC & COLOR SLEEVE

YATO	V	
YT-82788	18	4

- GB Cordless impact drill / driver (tool only)
- D Akku-Schlagbohrschrauber (nur das Gerät)
- PL Akumulatorowa wiertarko-wkrętarka udarowa (tylko narzędzie)
- RUS Аккумуляторная ударный дрель-шуруповерт (только инструмент)
- CZ Akumulátorový nárazový šroubovák s příklepem (pouze nářadí)
- H Akkus ütvefűrógép (csak a szerszámot)
- RO Mașină de găurit cu percucie cu accumulator (numai sculă)
- F Perceuse-visseuse percussion sans-fil (outil seulement)
- I Trapano avvitatore a percussione a batteria (solo utensile)
- E Taladro / atornillador con percusión a batería (herramienta solamente)
- CN 充电式冲击钻 (光机)

18 V	Li-Ion	40 Nm	0-440 min ⁻¹ 0-1650 min ⁻¹	T 0-7920 min ⁻¹ 0-29700 min ⁻¹
1h*	QUICK CHARGING SYSTEME SZYBIE ŁADOWANIE	13mm		



* given charging time is for 2.0 Ah battery only

$L_{pA} = 71.0 \pm 3.0$ dB;
 $L_{wA} = 82.0 \pm 3.0$ dB;
 $a_{a0} = 3.0 \pm 1.5 / 9.89 \pm 1.5$ m/s²

battery not included
akumulatora nie dołączono

YATO	V	
YT-82789	18	5

GB Brushless cordless drill / driver
D Bürstenloser Akku-Bohrschrauber
PL Bezszczotkowa wiertarko-wkrętarka akumulatorowa
RUS Бесщеточный аккумуляторный ударный дрель-шурупверт
CZ Bezkartáčový akumulátorový vrtací šroubovák s příklepem
H Szénkefe nélküli akkus fúrócsavarozók
RO Mașină de găurit / înșurubat cu acumulator fără perii
F Perceuse-visseuse sans-fi
I Trapano avvitatore senza spazzole a batteria
E Taladro / atornillador a batería sin escobillas
CN 充电式无刷电钻

18 V	Li-Ion	42 Nm	0-600 min ⁻¹ 0-2000 min ⁻¹	2.0 Ah
		1h QUICK CHARGING SYSTEM ŁADOWANIE	13mm	



$L_{pA} = 74.0 \pm 3.0$ dB;
 $L_{wA} = 85.0 \pm 3.0$ dB;
 $a_v = 3.0 \pm 1.5$ m/s²

BMC & COLOR SLEEVE

YATO	V	
YT-82794	18	4

GB Brushless cordless drill / driver (tool only)
D Bürstenloser Akku-Bohrschrauber (nur das Gerät)
PL Bezszczotkowa wiertarko-wkrętarka akumulatorowa (tylko narzędzie)
RUS Бесщеточный аккумуляторный ударный дрель-шурупверт (только инструмент)
CZ Bezkartáčový akumulátorový vrtací šroubovák s příklepem (pouze nářadí)
H Szénkefe nélküli akkus fúrócsavarozók (csak a szerszámot)
RO Mașină de găurit / înșurubat cu acumulator fără perii (numai sculă)
F Perceuse-visseuse sans-fil sans charbon (outil seulement)
I Trapano avvitatore senza spazzole a batteria (solo utensile)
E Taladro / atornillador a batería sin escobillas (herramienta solamente)
CN 充电式无刷冲击钻 (光机)

18 V	Li-Ion	42 Nm	0-600 min ⁻¹ 0-2000 min ⁻¹	1h* QUICK CHARGING SYSTEM ŁADOWANIE
		13mm		



* given charging time is for 2.0 Ah battery only

$L_{pA} = 74.0 \pm 3.0$ dB;
 $L_{wA} = 85.0 \pm 3.0$ dB;
 $a_v = 3.0 \pm 1.5$ m/s²

COLOR BOX

battery not included
akumulatora nie dołączono

YATO	V	
YT-82795	18	5

GB Brushless cordless drill / driver
D Bürstenloser Akku-Bohrschrauber
PL Bezszczotkowa wiertarko-wkrętarka akumulatorowa
RUS Бесщеточный аккумуляторный ударный дрель-шурупверт
CZ Bezkartáčový akumulátorový vrtací šroubovák s příklepem
H Szénkefe nélküli akkus fúrócsavarozók
RO Mașină de găurit / înșurubat cu acumulator fără perii
F Perceuse-visseuse sans-fil sans charbon
I Trapano avvitatore senza spazzole a batteria
E Taladro / atornillador a batería sin escobillas
CN 充电式无刷电钻

18 V	Li-Ion	42 Nm	0-600 min ⁻¹ 0-2000 min ⁻¹	T 0-10800 min ⁻¹ 0-36000 min ⁻¹
		2.0 Ah	1h QUICK CHARGING SYSTEM ŁADOWANIE	13mm

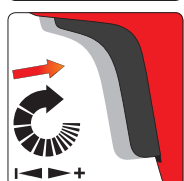

$L_{pA} = 73.0 \pm 3.0$ dB;
 $L_{wA} = 94.0 \pm 3.0$ dB;
 $a_v = 3.0 \pm 1.5 / 9.56 \pm 1.5$ m/s²

BMC & COLOR SLEEVE

YATO	V	
YT-82796	18	4

GB Brushless cordless drill / driver (tool only)
D Bürstenloser Akku-Bohrschrauber (nur das Gerät)
PL Bezszczotkowa wiertarko-wkrętarka akumulatorowa (tylko narzędzie)
RUS Бесщеточный аккумуляторный ударный дрель-шурупверт (только инструмент)
CZ Bezkartáčový akumulátorový vrtací šroubovák s příklepem (pouze nářadí)
H Szénkefe nélküli akkus fúrócsavarozók (csak a szerszámot)
RO Mașină de găurit / înșurubat cu acumulator fără perii (numai sculă)
F Perceuse-visseuse sans-fil sans charbon (outil seulement)
I Trapano avvitatore senza spazzole a batteria (solo utensile)
E Taladro / atornillador a batería sin escobillas (herramienta solamente)
CN 充电式无刷冲击钻 (光机)

18 V	Li-Ion	42 Nm	0-600 min ⁻¹ 0-2000 min ⁻¹	T 0-10800 min ⁻¹ 0-36000 min ⁻¹
		1h* QUICK CHARGING SYSTEM ŁADOWANIE	13mm	



* given charging time is for 2.0 Ah battery only

$L_{pA} = 73.0 \pm 3.0$ dB;
 $L_{wA} = 94.0 \pm 3.0$ dB;
 $a_v = 3.0 \pm 1.5 / 9.56 \pm 1.5$ m/s²

COLOR BOX

battery not included
akumulatora nie dołączono

YATO	V	
YT-82797	18	5

- GB Cordless impact screwdriver
- D Akku-Schlagbohrschrauber
- PL Akumulatorowa zakrętkarka udarowa
- RUS Аккумуляторный ударный гайковёрт
- CZ Akumulátorový rázový utahovák
- H Akkus ütvecsavarozó
- RO Şurubelniţă cu impact cu acumulator
- F Boulonneuse sans-fil
- I Avvitatore a percussione a batteria
- E Atornillador de impacto a batería
- CN 充电式冲击螺丝批

18 V	Li-Ion	160 Nm	0-3000 min ⁻¹	T
1/4"	2.0 Ah	1h	LED	QUICK CHARGING SYSTEME LADUNGSAME
6.3mm			BATTERY INDICATOR	



$L_{pA} = 82.0 \pm 3.0$ dB;
 $L_{wA} = 93.0 \pm 3.0$ dB;
 $a_n = 8.15 \pm 1.5$ m/s²

18V Li-Ion!

COLOR BOX

YATO	V	
YT-82800	18	5

- GB Cordless impact screwdriver (tool only)
- D Akku-Schlagbohrschrauber (nur das Gerät)
- PL Akumulatorowa zakrętkarka udarowa (tylko narzędzie)
- RUS Аккумуляторный ударный гайковёрт (только инструмент)
- CZ Akumulátorový rázový utahovák (pouze nářadí)
- H Akkus ütvecsavarozó (csak a szerszámot)
- RO Şurubelniţă cu impact cu acumulator (numai sculă)
- F Boulonneuse sans-fil (outil seulement)
- I Avvitatore a percussione a batteria (solo utensile)
- E Atornillador de impacto a batería (herramienta solamente)
- CN 充电式冲击螺丝批 (光机)

18 V	Li-Ion	160 Nm	0-3000 min ⁻¹	T
1/4"	1h*	LED	QUICK CHARGING SYSTEME LADUNGSAME	
6.3mm			BATTERY INDICATOR	



18V Li-Ion!

* given charging time is for 2.0 Ah battery only

$L_{pA} = 82.0 \pm 3.0$ dB;
 $L_{wA} = 93.0 \pm 3.0$ dB;
 $a_n = 8.15 \pm 1.5$ m/s²

COLOR BOX

battery not included
akumulatora nie dołączono

YATO	V	
YT-82801	18	5

- GB Cordless impact wrench
- D Akku-DrehSchlagschrauber
- PL Akumulatorowy klucz udarowy
- RUS Аккумуляторный ударный гайковёрт
- CZ Akumulátorový rázový utahovák
- H Akkus ütvecsavarozó
- RO Şurubelniţă cu impact cu acumulator
- F Boulonneuse sans-fil
- I Chiave a percussione a batteria
- E Atornillador de impacto a batería
- CN 充电式冲击扳手

18 V	Li-Ion	300 Nm	0-2200 min ⁻¹	T
1/2"	2.0 Ah	1h	LED	QUICK CHARGING SYSTEME LADUNGSAME
12.5mm			BATTERY INDICATOR	

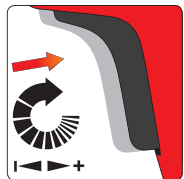

$L_{pA} = 84.0 \pm 3.0$ dB;
 $L_{wA} = 95.0 \pm 3.0$ dB;
 $a_n = 9.09 \pm 1.5$ m/s²

18V Li-Ion!

BMC & COLOR SLEEVE

YATO	V	
YT-82804	18	4

- GB Cordless impact wrench (tool only)
- D Akku-DrehSchlagschrauber (nur das Gerät)
- PL Akumulatorowy klucz udarowy (tylko narzędzie)
- RUS Аккумуляторный ударный гайковёрт (только инструмент)
- CZ Akumulátorový rázový utahovák (pouze nářadí)
- H Akkus ütvecsavarozó (csak a szerszámot)
- RO Şurubelniţă cu impact cu acumulator (numai sculă)
- F Boulonneuse sans-fil (outil seulement)
- I Chiave a percussione a batteria (solo utensile)
- E Atornillador de impacto a batería (herramienta solamente)
- CN 充电式冲击扳手 (光机)

18 V	Li-Ion	300 Nm	0-2200 min ⁻¹	T
1/2"	1h*	LED	QUICK CHARGING SYSTEME LADUNGSAME	
12.5mm			BATTERY INDICATOR	



18V Li-Ion!

* given charging time is for 2.0 Ah battery only

$L_{pA} = 84.0 \pm 3.0$ dB;
 $L_{wA} = 95.0 \pm 3.0$ dB;
 $a_n = 9.09 \pm 1.5$ m/s²

COLOR BOX

battery not included
akumulatora nie dołączono

YATO	V	
YT-82805	18	5

GB Cordless impact wrench
D Akku-schlagschrauber
PL Akumulatorowy klucz udarowy
RUS Аккумуляторный ударный гайковерт
CZ Akumulátorový rázový utahovák
H Akkus ütvecsavarozó
RO Pistol impact cu acumulator
F Clé a choc sans fil
I Chiave ad impulsi con chiavi a bussola esagonale
E Inalámbrico llave de impacto
CN 气动棘轮扳手

1/2" 12.5mm	280 Nm	18 V	0-2200 rpm	0-3300 mm	Li-Ion
3000 mAh	2h QUICK CHARGING SYSTEME LADOWANIE	LED BATTERY INDICATOR SYSTEME NAPOWIADZANIE AKUMULATORA	17,19 21,22 mm		

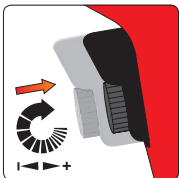

$L_{pA} = 87,5 \pm 3,0$ dB;
 $L_{pM} = 98,5 \pm 3,0$ dB;
 $a_p = 9,93 \pm 1,5$ m/s²



BMC & COLOR SLEEVE

YATO	Nm	
YT-82930	280	3

GB Cordless impact wrench
D Akku-schlagschrauber
PL Akumulatorowy klucz udarowy
RUS Аккумуляторный ударный гайковерт
CZ Akumulátorový rázový utahovák
H Akkus ütvecsavarozó
RO Pistol impact cu acumulator
F Clé a choc sans fil
I Chiave ad impulsi con chiavi a bussola esagonale
E Inalámbrico llave de impacto
CN 气动棘轮扳手

1/2" 12.5mm	280 Nm	18 V	0-2200 rpm	0-3300 mm	Li-Ion
3000 mAh	2h QUICK CHARGING SYSTEME LADOWANIE	LED BATTERY INDICATOR SYSTEME NAPOWIADZANIE AKUMULATORA	17,19 21,22 mm		

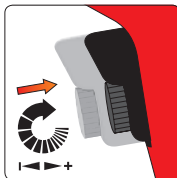

$L_{pA} = 87,5 \pm 3,0$ dB;
 $L_{pM} = 98,5 \pm 3,0$ dB;
 $a_p = 9,93 \pm 1,5$ m/s²

BMC & COLOR SLEEVE

YATO	Nm	
YT-82931	280	3

GB Battery
D Akkumulator
PL Akumulator
RUS Аккумулятор
CZ Akumulátor
H Akkumulátor
RO Acumulatorul
F Batterie
I Batteria
E Bateria
CN 锂电池



for / dla:
YT-82930,
YT-82931

18 V	Li-Ion	3000 mAh	2h QUICK CHARGING SYSTEME LADOWANIE
----------------	---------------	--------------------	---

WHITE CARTON BOX & COLOR LABEL



YATO	V	
YT-82932	18	20

GB Cordless screwdriver
D Akku-schrauber
PL Wkrętak akumulatorowy
RUS Аккумуляторный шуруповерт
CZ Akumulátorový utahovák
H Akkus csavarbehajtó
RO Şurubelniţă cu acumulator
F Tournevis sans fil
I Avvitatore a batteria
E Herramienta de resistencia para soldar
CN 充电式螺丝批



3.6 V 1300 mAh Li-Ion	Li-Ion	230 min ⁻¹	3.0 Nm
LED BATTERY INDICATOR SYSTEME NAPOWIADZANIE AKUMULATORA	WORKING AREA LIGHT OSWIETLENIE OBSZARU PRACY		



$L_{pA} = 61,7 \pm 3,0$ dB;
 $L_{pM} = 72,7 \pm 3,0$ dB;
 $a_p = 0,39 \pm 1,5$ m/s²

COLOR BOX



YATO	V	
YT-82760	3.6	20

- GB Cordless circular saw
- D Akku-Handkreissäge
- PL Akumulatorowa pilarka tarczowa
- RUS Аккумуляторная циркулярная пила
- CZ Akumulátorová okružní pila
- H Akkus körfűrész
- RO Ferăstrău circular cu acumulator
- F Scie circulaire sans-fil
- I Sega circolare a batteria
- E Sierra circular a batería
- CN 充电式电圆锯 (光机)

18 V	Li-Ion	3800 min⁻¹	2.0 Ah	1h QUICK CHARGING SZYBKIE ŁADOWANIE
			24T	
\varnothing (mm) 185 x 18 x 2,4 (max)		54 mm		\angle 90°-54 mm / 45°-40 mm



18V
Li-Ion

$L_{pA} = 85,0 \pm 3,0$ dB;
 $L_{pM} = 96,0 \pm 3,0$ dB;
 $a_w = 5,33 \pm 1,5$ m/s²

YATO	V	
YT-82810	18	2

- GB Cordless circular saw (tool only)
- D Akku-Handkreissäge (nur das Gerät)
- PL Akumulatorowa pilarka tarczowa (tylko narzędzie)
- RUS Аккумуляторная циркулярная пила (только инструмент)
- CZ Akumulátorová okružní pila (pouze nářadí)
- H Akkus körfűrész (csak a szerszámot)
- RO Ferăstrău circular cu acumulator (numai sculă)
- F Scie circulaire sans-fil (outil seulement)
- I Sega circolare a batteria (solo utensile)
- E Sierra circular a batería (herramienta solamente)
- CN 充电式电圆锯 (光机)

18 V	Li-Ion	3800 min⁻¹	1h* QUICK CHARGING SZYBKIE ŁADOWANIE
			24T
\varnothing (mm) 185 x 18 x 2,4 (max)		54 mm	
		\angle 90°-54 mm / 45°-40 mm	



18V
Li-Ion

$L_{pA} = 85,0 \pm 3,0$ dB;
 $L_{pM} = 96,0 \pm 3,0$ dB;
 $a_w = 5,33 \pm 1,5$ m/s²

* given charging time is for 2.0 Ah battery only

* podany czas ładowania dotyczy tylko akumulatora 2.0 Ah

battery not included
akumulatora nie dołączono

YATO	V	
YT-82811	18	2

- GB Cordless sabre saw
- D Akku-Säbelsäge
- PL Akumulatorowa pila szablasta
- RUS Аккумуляторная шабельная пила
- CZ Akumulátorová pila ocaska
- H Akkus szablyafűrész
- RO Ferăstrău sabie cu acumulator
- F Scie sabre sans-fil
- I Sega a gattuccio a batteria
- E Sierra sable de batería
- CN 充电式复往锯



18V
Li-Ion

$L_{pA} = 81,0 \pm 3,0$ dB;
 $L_{pM} = 92,0 \pm 3,0$ dB;
 $a_w = 7,5 \pm 1,5 / 8,3 \pm 1,5$ m/s²



YATO	V	
YT-82814	18	4

- GB Cordless sabre saw (tool only)
- D Akku-Säbelsäge (nur das Gerät)
- PL Akumulatorowa pila szablasta (tylko narzędzie)
- RUS Аккумуляторная шабельная пила (только инструмент)
- CZ Akumulátorová pila ocaska (pouze nářadí)
- H Akkus szablyafűrész (csak a szerszámot)
- RO Ferăstrău sabie cu acumulator (numai sculă)
- F Scie sabre sans-fil (outil seulement)
- I Sega a gattuccio a batteria (solo utensile)
- E Sierra sable de batería (herramienta solamente)
- CN 充电式复往锯 (光机)



18V
Li-Ion

$L_{pA} = 81,0 \pm 3,0$ dB;
 $L_{pM} = 92,0 \pm 3,0$ dB;
 $a_w = 7,5 \pm 1,5 / 8,3 \pm 1,5$ m/s²



battery not included
akumulatora nie dołączono

* given charging time is for 2.0 Ah battery only

* podany czas ładowania dotyczy tylko akumulatora 2.0 Ah

YATO	V	
YT-82815	18	4

- GB Multi-purpose oscillating tool
D Multifunktionales Oszillationswerkzeug
PL Wielofunkcyjne narzędzie oscylacyjne
RUS Многофункциональный инструмент
CZ Multifunkční oscilační nářadí
H Multifunkciós rezgő szerszám
RO Unealtă multifuncțională oscilantă
F Outil multifonctions oscillant
I Oscillante strumento multifunzione
E Herramienta oscilatoria multiusos
CN 多功能啊雄莓



10.8 V Li-Ion 1h QUICK CHARGING SYSTEM 5000-15000 min!

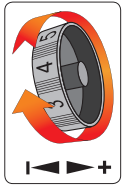

$L_{pA} = 78,20 \pm 3,0$ dB;
 $L_{pM} = 89,20 \pm 3,0$ dB;
 $a_w = 1,609 \pm 1,5 / 2,503 \pm 1,5$ m/s²

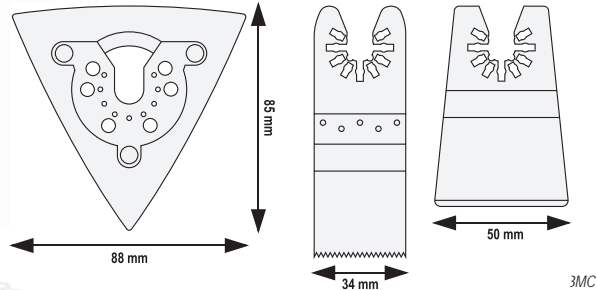

CUTTING / CIĘCIE SANDING / SZLIFOWANIE SCRAPING / ZDRAPYWANIE

additional battery in set
dodatkowy akumulator w zestawie

YATO	V	
YT-82900	10.8	5

- GB Battery
D Akkumulator
PL Akumulator
RUS Аккумулятор
CZ Akumulátor
H Akkumulátor
RO Acumulatorul
F Batterie
I Batteria
E Bateria
CN 锂电池



10.8 V Li-Ion 1h QUICK CHARGING SYSTEM 1500 mAh

WHITE CARTON BOX & COLOR LABEL



for / dla:
YT-82850,
YT-82900

YATO	V	
YT-82857	10.8	40

- GB Battery charger
D Ladegerät
PL Ładowarka
RUS Зарядное устройство
CZ Nabíječka
H Akkutöltő
RO Redresor
F Chargeur de batterie
I Caricabatteria
E Rectificador
CN 充电器



230V~50Hz for/dla: 10.8V Li-Ion 1h QUICK CHARGING SYSTEM

WHITE CARTON BOX & COLOR LABEL



for / dla:
YT-82851,
YT-82857,
YT-82900

YATO	V	
YT-82861	10.8	8

- GB Cordless multi-purpose oscillating tool
D Akku-Multifunktionswerkzeug
PL Akumulatorowe wielofunkcyjne narzędzie oscylacyjne
RUS Аккумуляторный многофункциональный инструмент
CZ Akumulátorová multifunkční pila
H Akkus multifunkcionális vágószerszám
RO Mașină multifuncțională cu acumulator
F Découpeur-ponceur multifonctions sans-fil
I Utensile oscillante multifunzione a batteria
E Multiherramienta a batería
CN 充电式多功能锯



18 V Li-Ion 2.0 Ah 1h QUICK CHARGING SYSTEM 8000-18000 min!

CUTTING / CIĘCIE CUTTING / CIĘCIE
SANDING / SZLIFOWANIE SCRAPING / ZDRAPYWANIE

$L_{pA} = 77,0 \pm 3,0$ dB; $L_{pM} = 88,0 \pm 3,0$ dB; $a_w = 4,68 \pm 1,5$ m/s²

YATO	V	
YT-82818	18	4

- GB** Cordless multi-purpose oscillating tool (tool only)
- D** Akku-Multifunktionswerkzeug (nur das Gerät)
- PL** Akumulatorowe wielofunkcyjne narzędzie oscylacyjne (tylko narzędzie)
- RUS** Аккумуляторный многофункциональный инструмент (только инструмент)
- CZ** Akumulátorová multifunkční pila (pouze nářadí)
- H** Akkus multifunkcionális vágószerszám (csak a szerszámot)
- RO** Mașină multifuncțională cu acumulator (numai sculă)
- F** Découpeur-ponceur multifonctions sans-fil (outil seulement)
- I** Utensile oscillante multifunzione a batteria (solo utensile)
- E** Multiherramienta a batería (herramienta solamente)
- CN** 充电式多功能锯 (光机)



18V
Li-Ion

18 V

Li-Ion

8000-18000 min⁻¹

1h*
QUICK CHARGING SYSTEM
SZRÓDRAJÓZÁS

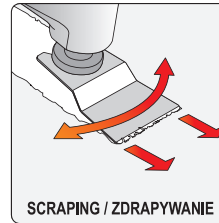
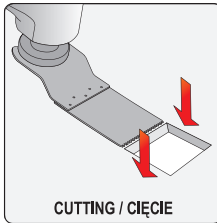
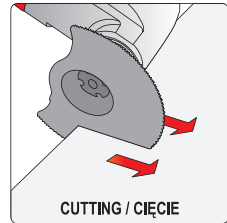
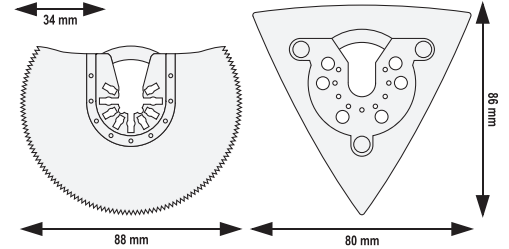
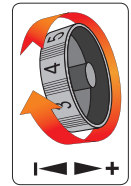
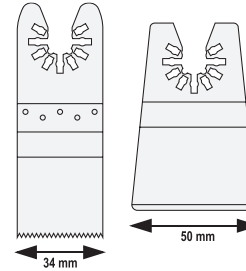
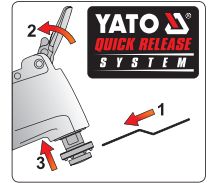

* given charging time is for 2.0 Ah battery only

battery not included
akumulatora nie dołączono

* podany czas ładowania dotyczy tylko akumulatora 2.0 Ah

L_{pa} = 77,0 ± 3,0 dB;
L_{wa} = 88,0 ± 3,0 dB;
a_{wa} = 4,68 ± 1,5 m/s²



YATO	V	
YT-82819	18	4

- GB** Cordless jig saw
- D** Akku-Stichsäge
- PL** Akumulatorowa wyrzynarka
- RUS** Аккумуляторная лобзиковая пила
- CZ** Akumulátorová přímočará pila
- H** Akkus szúrőfűrész
- RO** Ferăstrău vertical cu acumulator
- F** Scie sauteuse sans-fil
- I** Seghetto alternativo a batteria
- E** Sierra de calar a batería
- CN** 充电式曲线锯



18 V
Li-Ion
0-2500 min⁻¹
2.0 Ah
1h
QUICK CHARGING SYSTEM
SZRÓDRAJÓZÁS
5 mm
45°

- GB** Cordless jig saw (tool only)
- D** Akku-Stichsäge (nur das Gerät)
- PL** Akumulatorowa wyrzynarka (tylko narzędzie)
- RUS** Аккумуляторная лобзиковая пила (только инструмент)
- CZ** Akumulátorová přímočará pila (pouze nářadí)
- H** Akkus szúrőfűrész (csak a szerszámot)
- RO** Ferăstrău vertical cu acumulator (numai sculă)
- F** Scie sauteuse sans-fil (outil seulement)
- I** Seghetto alternativo a batteria (solo utensile)
- E** Sierra de calar a batería (herramienta solamente)
- CN** 充电式曲线锯 (光机)



18 V
Li-Ion
0-2500 min⁻¹
1h*
QUICK CHARGING SYSTEM
SZRÓDRAJÓZÁS
5 mm
45°



L_{pa} = 76,0 ± 3,0 dB;
L_{wa} = 87,0 ± 3,0 dB;
a_{wa} = 6,28 ± 1,5 / 5,78 ± 1,5 m/s²

* given charging time is for 2.0 Ah battery only

18V
Li-Ion

battery not included
akumulatora nie dołączono

* podany czas ładowania dotyczy tylko akumulatora 2.0 Ah



18V
Li-Ion

L_{pa} = 76,0 ± 3,0 dB;
L_{wa} = 87,0 ± 3,0 dB;
a_{wa} = 6,28 ± 1,5 / 5,78 ± 1,5 m/s²

YATO	V	
YT-82822	18	4



YATO	V	
YT-82823	18	5

- GB Cordless angle grinder
D Akku-Winkelschleifer
PL Akumulatorowa szlifierka kątowa
RUS Аккумуляторная угловая шлифмашина
CZ Akumulátorová úhlová bruska
H Akkus sarokcsiszoló
RO Polizor unghiular cu acumulator
F Meuleuse angulaire sans-fil
I Smeragliatrice angolare a batteria
E Amoladora angular a batería
CN 充电式角磨

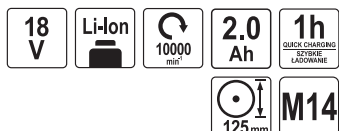

18V
Li-Ion

$L_{pa} = 88,0 \pm 3,0$ dB;
 $L_{ma} = 99,0 \pm 3,0$ dB;
 $a_s = 4,9 \pm 1,5$ m/s²

YATO	V	
YT-82826	18	4

COLOR BOX

- GB Cordless angle grinder (tool only)
D Akku-Winkelschleifer (nur das Gerät)
PL Akumulatorowa szlifierka kątowa (tylko narzędzie)
RUS Аккумуляторная угловая шлифмашина (только инструмент)
CZ Akumulátorová úhlová bruska (pouze nářadí)
H Akkus sarokcsiszoló (csak a szerszámot)
RO Polizor unghiular cu acumulator (numai sculă)
F Meuleuse angulaire sans-fil (outil seulement)
I Smeragliatrice angolare a batteria (solo utensile)
E Amoladora angular a batería (herramienta solamente)
CN 充电式角磨 (光机)

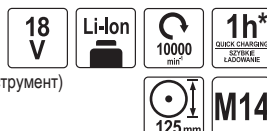

18V
Li-Ion

battery not included
akumulatora nie dołączono

YATO	V	
YT-82827	18	4

COLOR BOX

$L_{pa} = 88,0 \pm 3,0$ dB;
 $L_{ma} = 99,0 \pm 3,0$ dB;
 $a_s = 4,9 \pm 1,5$ m/s²

- GB Cordless grass trimmer
D Akku-Rasentrimmer
PL Akumulatorowa podkaszarka do trawy
RUS Аккумуляторный триммер
CZ Akumulátorová sekačka na trávu
H Akkus szegélynyíró
RO Trimmere de gazon cu acumulator
F Débroussaileuse sans-fil
I Tagliabordi a batteria
E Desbrozadora a batería
CN 充电式打草机



YATO	V	
YT-82830	18	2

COLOR BOX

108-137cm

$L_{pa} = 85,0 \pm 3,0$ dB;
 $L_{ma} = 93,0 \pm 3,0$ dB;
 $a_s = 2,5 \pm 1,5$ m/s²

18V
Li-Ion

- GB Cordless grass trimmer (tool only)
D Akku-Rasentrimmer (nur das Gerät)
PL Akumulatorowa podkaszarka do trawy (tylko narzędzie)
RUS Аккумуляторный триммер (только инструмент)
CZ Akumulátorová sekačka na trávu (pouze nářadí)
H Akkus szegélynyíró (csak a szerszámot)
RO Trimmere de gazon cu acumulator (numai sculă)
F Débroussaileuse sans-fil (outil seulement)
I Tagliabordi a batteria (solo utensile)
E Desbrozadora a batería (herramienta solamente)
CN 充电式打草机 (光机)



YATO	V	
YT-82831	18	2

COLOR BOX

battery not included
akumulatora nie dołączono

* given charging time is for 2.0 Ah battery only
* podany czas ładowania dotyczy tylko akumulatora 2.0 Ah

18V
Li-Ion

$L_{pa} = 85,0 \pm 3,0$ dB;
 $L_{ma} = 93,0 \pm 3,0$ dB;
 $a_s = 2,5 \pm 1,5$ m/s²

- GB Cordless hedge trimmer
D Akku-Heckenschere
PL Akumulatorowe nożyce do żywopłotu
RUS Аккумуляторный кусторез
CZ Akumulátorové nůžky na živé ploty
H Akkus sövénynyíró
RO Foarfece de tăiat gard viu cu acumulator
F Taille-haies sans-fil
I Tagliasiepi a batteria
E Cortasetos inalámbrico
CN 充电式高枝剪

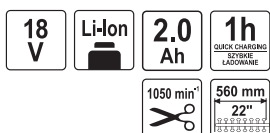

YATO	V	
YT-82832	18	2

COLOR BOX

18V
Li-Ion

$L_{pa} = 80,0 \pm 3,0$ dB;
 $L_{ma} = 87,0 \pm 3,0$ dB;
 $a_s = 3,5 \pm 1,5$ m/s²

- GB Cordless hedge trimmer (tool only)
D Akku-Heckenschere (nur das Gerät)
PL Akumulatorowe nożyce do żywopłotu (tylko narzędzie)
RUS Аккумуляторный кусторез (только инструмент)
CZ Akumulátorové nůžky na živé ploty (pouze nářadí)
H Akkus sövénynyíró (csak a szerszámot)
RO Foarfece de tăiat gard viu cu acumulator (numai sculă)
F Taille-haies sans-fil (outil seulement)
I Tagliasiepi a batteria (solo utensile)
E Cortasetos inalámbrico (herramienta solamente)
CN 充电式高枝剪 (光机)

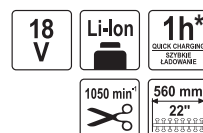

YATO	V	
YT-82833	18	2

COLOR BOX

battery not included
akumulatora nie dołączono

* given charging time is for 2.0 Ah battery only
* podany czas ładowania dotyczy tylko akumulatora 2.0 Ah

$L_{pa} = 80,0 \pm 3,0$ dB;
 $L_{ma} = 87,0 \pm 3,0$ dB;
 $a_s = 3,5 \pm 1,5$ m/s²

18V
Li-Ion

- GB** Cordless hedge trimmer
D Akku-Heckenschere
PL Akumulatorowe nożyce do żywopłotu
RUS Аккумуляторный кусторез
CZ Akumulátorové nožky na živé ploty
H Akkus sövénynyíró
RO Foarfece de tăiat gard viu cu acumulator
F Taille-haies sans-fil
I Tagliasiepi a batteria
E Tijera cortasetos a batería
CN 充电式高枝剪

18 V Li-Ion 2.0 Ah 1h QUICK CHARGING SYSTEM LAZOWANIE
 2100 min¹ 420 mm

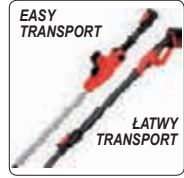

L_{pa} = 77.3 ± 3.0 dB;
 L_{wa} = 88.1 ± 3.0 dB;
 a_v = 1.5 ± 1.5 m/s²

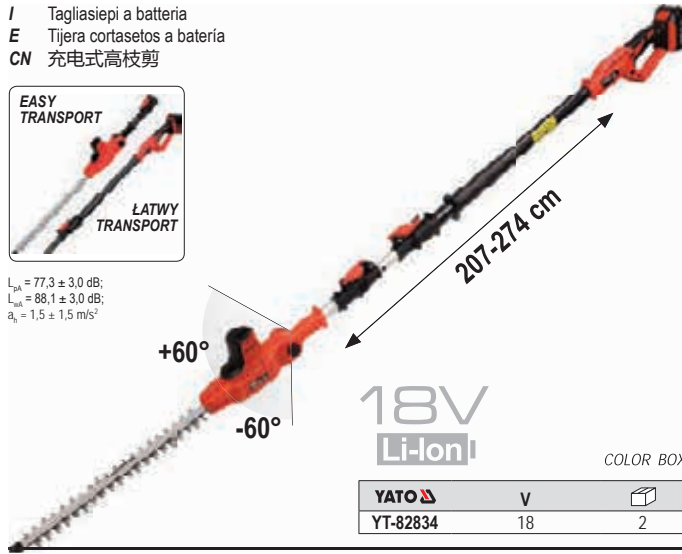

- GB** Cordless hedge trimmer (tool only)
D Akku-Heckenschere (nur das Gerät)
PL Akumulatorowe nożyce do żywopłotu (tylko narzędzie)
RUS Аккумуляторный кусторез (только инструмент)
CZ Akumulátorové nožky na živé ploty (pouze nářadí)
H Akkus sövénynyíró (csak a szerszámot)
RO Foarfece de tăiat gard viu cu acumulator (numai sculă)
F Taille-haies sans-fil (outil seulement)
I Tagliasiepi a batteria (solo utensile)
E Tijera cortasetos a batería (herramienta solamente)
CN 充电式高枝剪 (光机)

18 V Li-Ion 1h* QUICK CHARGING SYSTEM LAZOWANIE
 2100 min¹ 420 mm

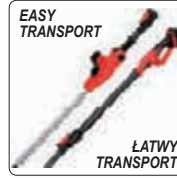

battery not included
 akumulatora
 nie dołączono

L_{pa} = 77.3 ± 3.0 dB;
 L_{wa} = 88.1 ± 3.0 dB;
 a_v = 1.5 ± 1.5 m/s²

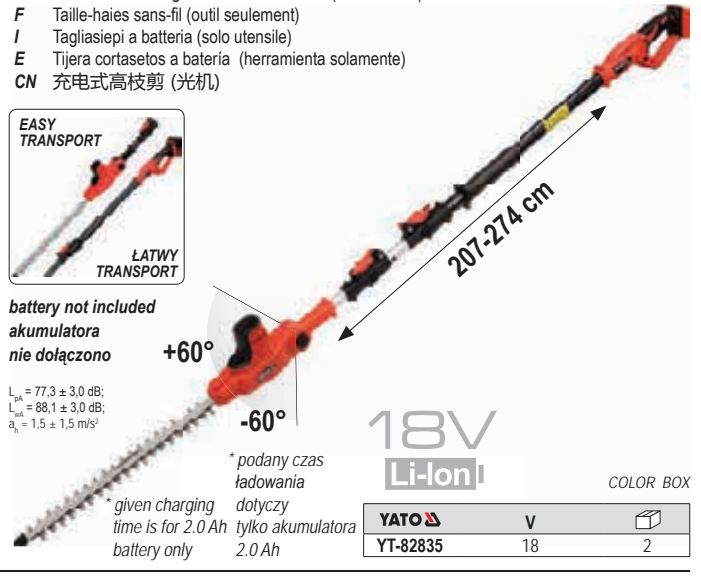

- GB** Cordless telescopic pole saw
D Akku-Teleskop-Hochtaster
PL Akumulatorowe okrzyszawarka na wysięgniku
RUS Аккумуляторный телескопический высоторез
CZ Akumulátorová teleskopická vyvėtovací pila
H Akkus magassági ágavágó távcsőves
RO Ferăstraie cu lanț cu telescopic cu acumulator
F Elagueuse sur perche télescopique sans-fil
I Decescupigliatore telescopico a batteria
E Sierra de pértiga telescópica a batería
CN 充电式高枝锯

18 V Li-Ion 2.0 Ah 1h QUICK CHARGING SYSTEM LAZOWANIE
 2500 min¹ 8" 20 cm 5 m/s

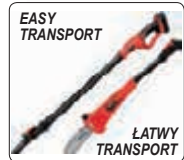

L_{pa} = 78.2 ± 3.0 dB;
 L_{wa} = 91.2 ± 2.36 dB;
 a_v = 2.109 ± 1.5 m/s²



- GB** Cordless telescopic pole saw (tool only)
D Akku-Teleskop-Hochtaster (nur das Gerät)
PL Akumulatorowe okrzyszawarka na wysięgniku (tylko narzędzie)
RUS Аккумуляторный телескопический высоторез (только инструмент)
CZ Akumulátorová teleskopická vyvėtovací pila (pouze nářadí)
H Akkus magassági ágavágó távcsőves (csak a szerszámot)
RO Ferăstraie cu lanț cu telescopic cu acumulator (numai sculă)
F Elagueuse sur perche télescopique sans-fil (outil seulement)
I Decescupigliatore telescopico a batteria (solo utensile)
E Sierra de pértiga telescópica a batería (herramienta solamente)
CN 充电式高枝锯 (光机)

18 V Li-Ion 1h* QUICK CHARGING SYSTEM LAZOWANIE
 2500 min¹ 8" 20 cm 5 m/s



battery not included
 akumulatora
 nie dołączono

L_{pa} = 78.2 ± 3.0 dB;
 L_{wa} = 91.2 ± 2.36 dB;
 a_v = 2.109 ± 1.5 m/s²

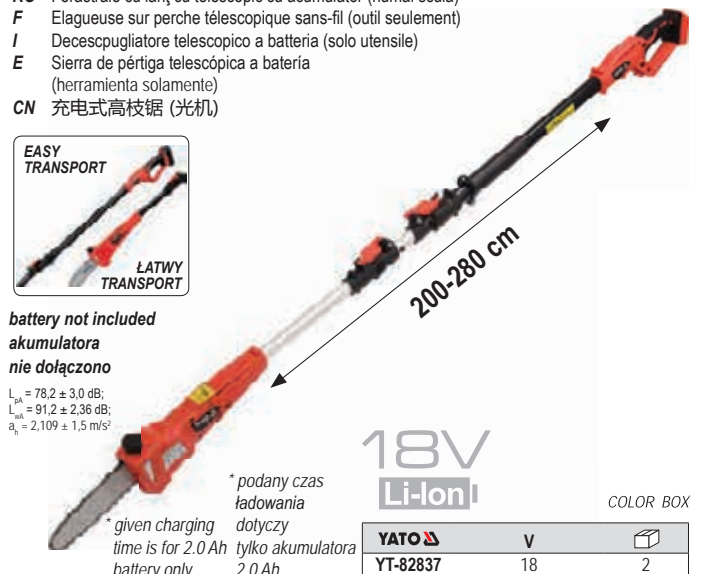

- GB** Battery
D Akkumulator
PL Akumulator
RUS Аккумулятор
CZ Akumulátor
H Akkumulátor
RO Acumulatorul
F Batterie
I Batteria
E Bateria
CN 锂电池

18V Li-Ion

18 V Li-Ion for/dla: Li-Ion



YATO	V	capacity / pojemność (Ah)	charging time / czas ładowania (h)	
YT-82842	18	2.0	1.0	20
YT-82843	18	3.0	1.5	20
YT-82844	18	4.0	2.0	20

- GB** Battery charger
D Ladegerät
PL Ładowarka
RUS Зарядное устройство
CZ Nabitječka
H Akkutöltő
RO Redresor
F Chargeur de batterie
I Caricabatteria
E Rectificador
CN 充电器

18V Li-Ion

for/dla: 18V Li-Ion 220-240 V-50/60 Hz



YATO	V	
YT-82848	18	8

GB Angle grinder
D Winkelschleifmaschine
PL Szlifierka kątowa
RUS Угловой шлифовальный станок
CZ Úhlová bruska

H Sarokcsiszoló
RO Polizor unghiular
F Meuleuse d'angle
I Smelgiatrice angolare
E Lijadera de angulo
CN 角向磨光机

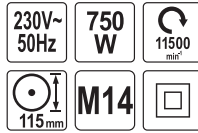

GB Angle grinder
D Winkelschleifmaschine
PL Szlifierka kątowa
RUS Угловой шлифовальный станок
CZ Úhlová bruska

H Sarokcsiszoló
RO Polizor unghiular
F Meuleuse d'angle
I Smelgiatrice angolare
E Lijadera de angulo
CN 角向磨光机

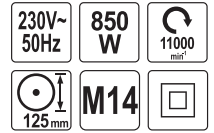

$L_{pa} = 87,6 \pm 3,0$ dB;
 $L_{wa} = 98,6 \pm 3,0$ dB;
 $a_s = 5,437 \pm 1,5 / 6,134 \pm 1,5$ m/s²

YATO	W	Box
YT-82091	720	8

$L_{pa} = 87,37 \pm 3,0$ dB;
 $L_{wa} = 98,37 \pm 3,0$ dB;
 $a_s = 7,131 \pm 1,5 / 5,852 \pm 1,5$ m/s²

YATO	W	Box
YT-82094	850	10

GB Angle grinder
D Winkelschleifmaschine
PL Szlifierka kątowa
RUS Угловой шлифовальный станок
CZ Úhlová bruska

H Sarokcsiszoló
RO Polizor unghiular
F Meuleuse d'angle
I Smelgiatrice angolare
E Lijadera de angulo
CN 角向磨光机

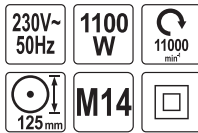

GB Angle grinder
D Winkelschleifmaschine
PL Szlifierka kątowa
RUS Угловой шлифовальный станок
CZ Úhlová bruska

H Sarokcsiszoló
RO Polizor unghiular
F Meuleuse d'angle
I Smelgiatrice angolare
E Lijadera de angulo
CN 角向磨光机

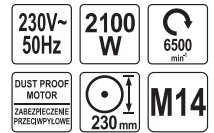

$L_{pa} = 79,0 \pm 3,0$ dB;
 $L_{wa} = 90,0 \pm 3,0$ dB;
 $a_s = 3,98 \pm 1,5$ m/s²

YATO	W	Box
YT-82100	1100	6

$L_{pa} = 99,75 \pm 3,0$ dB;
 $L_{wa} = 110,75 \pm 3,0$ dB;
 $a_s = 6,398 \pm 1,5 / 9,277 \pm 1,5$ m/s²

YATO	W	Box
YT-82103	2100	2

GB Car polisher
D Autopoliermaschine
PL Polerka samochodowa
RUS Полировальная машина
CZ Leštíčka na automobily
H Gépkocsi polírozógép
RO Masina de lustruit automobile
F Polisseur de voiture
I Levigatrice rotoorbitale
E Maquina para pulir coches
CN 抛光机

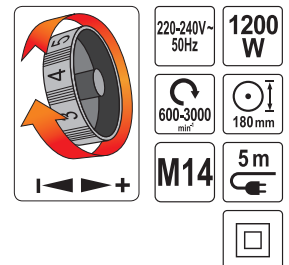

$L_{pa} = 84,54 \pm 3,0$ dB;
 $L_{wa} = 95,54 \pm 3,0$ dB;
 $a_s = 12,063 \pm 1,5 / 19,086 \pm 1,5$ m/s²

YATO	W	Box
YT-82195	1200	3

BMC
& COLOR SLEEVE

GB Grinding wheel cutter for metal
D Trennschleifer für Metall
PL Przecinarka ściernicowa do metalu
RUS Абразивно-отрезной станок по металлу
CZ Rozbrušovací pila na kovy
H Gyorsdaraboló fémhez
RO Ferăstrău abraziv pt. metal
F Scie à métaux
I Macchina da taglio

E Cortador abrasivo para metales
CN 型材切割机

230V~ 50Hz	2300 W
0-3800 min ⁻¹	355x25.4 mm
CUTTING CIECIE 0-90°	LONG LIFE MOTOR TRWALY SILNIK



COLOR BOX



$L_{pa} = 110,23 \pm 3,0$ dB;
 $L_{wa} = 123,23 \pm 3,0$ dB;
 $a_n = 2,417 \pm 1,5$ m/s²

YATO	W	
YT-82180	2300	1

GB Impact drill
D Schlagbohrmaschine
PL Wiertarka udarowa
RUS Ударная дрель
CZ Nárazová vrtačka
H Kezelési utasítás
RO Masina de gaurit
F Perceuse à percussion
I Trapano a percussione
E Taladradora de percusión
CN 冲击钻

220-240 V~ 50 Hz	710 W	0-2800 min ⁻¹	0-44800 min ⁻¹	
25 mm	13 mm			
13 mm	3 m			



COLOR BOX



$L_{pa} = 80,0 \pm 3,0$ dB;
 $L_{wa} = 91,0 \pm 3,0$ dB;
 $a_n = 2,95 \pm 1,5 / 8,46 \pm 1,5$ m/s²

YATO	W	
YT-82034	710	6

GB Impact drill
D Schlagbohrmaschine
PL Wiertarka udarowa
RUS Ударная дрель
CZ Nárazová vrtačka
H Kezelési utasítás
RO Masina de gaurit
F Perceuse à percussion
I Trapano a percussione
E Taladradora de percusión
CN 冲击钻

230V~ 50Hz	710 W	0-2300 min ⁻¹	
13 mm			



COLOR BOX



$L_{pa} = 85,0 \pm 3,0$ dB;
 $L_{wa} = 96,0 \pm 3,0$ dB;
 $a_n = 2,97 \pm 1,5 / 10,50 \pm 1,5$ m/s²

YATO	W	
YT-82035	710	5

GB Impact drill
D Schlagbohrmaschine
PL Wiertarka udarowa
RUS Ударная дрель
CZ Nárazová vrtačka
H Kezelési utasítás
RO Masina de gaurit
F Perceuse à percussion
I Trapano a percussione
E Taladradora de percusión
CN 冲击钻

220-240 V~ 50 Hz	810 W	0-2800 min ⁻¹	0-44800 min ⁻¹	
25 mm	13 mm			
13 mm	3 m			



COLOR BOX



$L_{pa} = 87,0 \pm 3,0$ dB;
 $L_{wa} = 98,0 \pm 3,0$ dB;
 $a_n = 2,29 \pm 1,5 / 8,50 \pm 1,5$ m/s²

YATO	W	
YT-82036	810	5

GB Impact drill
D Schlagbohrmaschine
PL Wiertarka udarowa
RUS Ударная дрель
CZ Nárazová vrtačka
H Kezelési utasítás
RO Masina de gaurit
F Perceuse à percussion
I Trapano a percussione
E Taladradora de percusión
CN 冲击钻



$L_{pA} = 89.0 \pm 3.0$ dB;
 $L_{wA} = 100.0 \pm 3.0$ dB;
 $a_s = 2.39 \pm 1.5 / 8.78 \pm 1.5$ m/s²

YATO	W	
YT-82037	850	5

GB Impact drill
D Schlagbohrmaschine
PL Wiertarka udarowa
RUS Ударная дрель
CZ Nárazová vrtačka
H Kezelési utasítás
RO Masina de gaurit
F Perceuse à percussion
I Trapano a percussione
E Taladradora de percusión
CN 冲击钻

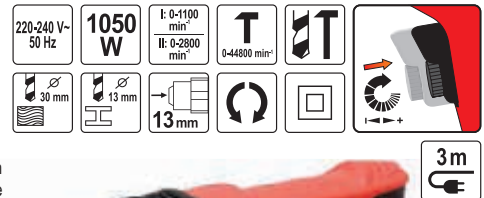

$L_{pA} = 97.0 \pm 3.0$ dB;
 $L_{wA} = 108.0 \pm 3.0$ dB;
 $a_s = 2.85 \pm 1.5 / 10.1 \pm 1.5$ m/s²

YATO	W	
YT-82044	1050	2

GB Electric drill
D Elektrobohrmaschine
PL Wiertarka elektryczna
RUS Электрическая дрель
CZ Elektrická vrtačka
H Elektromos fűrógép
RO Mașină de găurit electrică
F Perceuse à métal
I Trapano
E Taladro eléctrico
CN 电钻

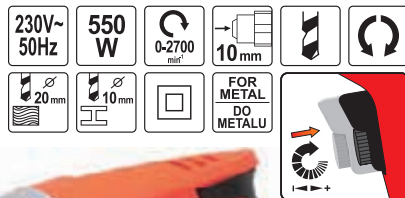

$L_{pA} = 92.0 \pm 3.0$ dB;
 $L_{wA} = 103.0 \pm 3.0$ dB;
 $a_s = 4.31 \pm 1.5$ m/s²

YATO	W	
YT-82050	550	5

GB Electric drill
D Elektrobohrmaschine
PL Wiertarka elektryczna
RUS Электрическая дрель
CZ Elektrická vrtačka
H Elektromos fűrógép
RO Mașină de găurit electrică
F Perceuse à métal
I Trapano
E Taladro eléctrico
CN 电钻

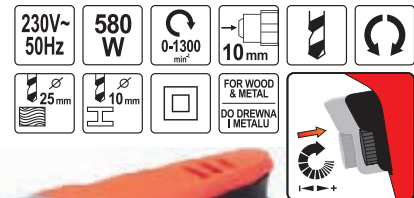

$L_{pA} = 92.0 \pm 3.0$ dB;
 $L_{wA} = 103.0 \pm 3.0$ dB;
 $a_s = 4.31 \pm 1.5$ m/s²

YATO	W	
YT-82051	580	5

GB Drywall screwdriver
D Trockenbauschrauber
PL Wkrętarka elektryczna
RUS Сетевой шуруповерт
CZ Sádronkartonářský šroubovák
H Gipszkarton csavarzó
RO Șurubelniță pt. gips-carton
F Perceuse aux plaques de plâtre
I Trapano
E Atornilladores para construcción en seco
CN 墙板螺丝刀



$L_{pA} = 86 \pm 3$ dB;
 $L_{wA} = 97 \pm 3$ dB;
 $a_s = 2.32 \pm 1.5$ m/s²

YATO	W	
YT-82070	500	5

GB Rotary hammer
D Bohrhämmer
PL Młotowiertarka
SDS-plus
RUS Перфоратор
CZ Vrtací kladivo
H Fűrókalapács
RO Ciocan rotopercurtor
F Marteau perforateur
I Martello rotativo
E Martillo perforador
CN 电锤



$L_{pA} = 91.8 \pm 3$ dB;
 $L_{wA} = 102.8 \pm 3$ dB;
 $a_s = 15.810 \pm 1.5 / 14.092 \pm 1.5$ m/s²

YATO	W	
YT-82120	850	4

BMC & COLOR SLEEVE

GB Rotary hammer
D Bohrhämmer
PL Młotowiertarka
SDS-plus
RUS Перфоратор
CZ Vrtací kladivo

H Fúrókalapács
RO Ciocan rotopercutor
F Marteau perforateur
I Martello rotativo
E Martillo perforador
CN 电锤

230V~50Hz	1250 W	800 min ⁻¹	T 3900 mm ²
	SDS PLUS	4J IMPACT ENERGY (ENERGIA UDARU)	



L_{pa} = 86,25 ± 3 / 92,4 ± 3 dB;
L_{wa} = 97,25 ± 3 / 103,4 ± 3 dB;
a_h = 15,105 ± 1,5 / 14,641 ± 1,5 m/s²

YATO	W	
YT-82125	1250	2

GB Rotary hammer
D Bohrhämmer
PL Młotowiertarka
SDS-plus
RUS Перфоратор
CZ Vrtací kladivo

H Fúrókalapács
RO Ciocan rotopercutor
F Marteau perforateur
I Martello rotativo
E Martillo perforador
CN 电锤

230V~50Hz	1500 W	800 min ⁻¹	T 3900 mm ²
	SDS PLUS	5J IMPACT ENERGY (ENERGIA UDARU)	



L_{pa} = 94,6 ± 3 dB;
L_{wa} = 105,6 ± 3 dB;
a_h = 19,167 ± 1,5 / 13,314 ± 1,5 m/s²

YATO	W	
YT-82127	1500	2

GB Rotary hammer
D Bohrhämmer
PL Młotowiertarka
SDS-plus
RUS Перфоратор
CZ Vrtací kladivo

H Fúrókalapács
RO Ciocan rotopercutor
F Marteau perforateur
I Martello rotativo
E Martillo perforador
CN 电锤

230V~50Hz	1050 W	0-480 min ⁻¹	T 0-3780 mm ²
	SDS MAX		9J IMPACT ENERGY (ENERGIA UDARU)



L_{pa} = 93,8 ± 3 / 95,8 ± 3 dB;
L_{wa} = 104,8 ± 3 / 106,8 ± 3 dB;
a_h = 14,89 ± 1,5 / 13,02 ± 1,5 m/s²

YATO	W	
YT-82130	1050	2

GB Rotary hammer
D Bohrhämmer
PL Młotowiertarka
SDS-plus
RUS Перфоратор
CZ Vrtací kladivo

H Fúrókalapács
RO Ciocan rotopercutor
F Marteau perforateur
I Martello rotativo
E Martillo perforador
CN 电锤

230V~50Hz	1600 W	175-350 min ⁻¹	T 1150-2350 mm ²
	SDS MAX		25J IMPACT ENERGY (ENERGIA UDARU)



L_{pa} = 96,1 ± 3,0 dB;
L_{wa} = 107,1 ± 3,0 dB;
a_h = 22,31 ± 1,5 / 20,91 ± 1,5 m/s²

YATO	W	
YT-82135	1600	1

GB Circular saw
D Handkreissäge
PL Pilarka elektryczna
RUS Дисковая пила
CZ Ručná kružná píla
H Kézi körfűrés
RO Ferăstrău circular de mana

F Tronçonneuse
I Sega circolare
E Sierra circular
CN 电圆锯

230V~50Hz	1300 W

--	--



L_{pa} = 98,64 ± 3,0 dB;
L_{wa} = 111,64 ± 3,0 dB;
a_h = 1,189 ± 1,5 / 1,180 ± 1,5 m/s²

YATO	W	
YT-82150	1300	2

GB Circular saw
D Handkreissäge
PL Pilarka elektryczna
RUS Дисковая пила
CZ Ručná kružná píla
H Kézi körfűrés

RO Ferăstrău circular de mana
F Tronçonneuse
I Sega circolare
E Sierra circular
CN 电圆锯

230V~50Hz	2000 W

--	--



L_{pa} = 98,64 ± 3,0 dB;
L_{wa} = 111,64 ± 3,0 dB;
a_h = 1,868 ± 1,5 / 2,513 ± 1,5 m/s²

YATO	W	
YT-82153	2000	2

- GB Mitre saw
D Paneelsäge
PL Ukoińska
RUS Панельная пила
CZ Pokosová pila se zákluzem
H Sínes gérvágó
RO Ferăstrău circular staționar

- F Scie à onglet radiale
I Sega angolare taglio leghe
E Ingletadora telescópica
CN 斜切锯



0°	95 mm
0°	310 mm
0°	95 mm
45°	210 mm
45°	50 mm
0°	310 mm
45°	50 mm
45°	210 mm

$L_{pa} = 86,0 \pm 3$ dB;
 $L_{wb} = 99,0 \pm 3$ dB;
 $a_s = 1,297 \pm 1,5$ m/s²

YATO	W	
YT-82171	1800	1

- GB Jig saw
D Stichsäge
PL Wyrzynarka
RUS Электрический лобзик
CZ Přímočará pila

- H Szűrőfűrész
RO Ferăstrău pt. traforaj
F Scie sauteuse
I Seghetto alternativo
E Sierra de calar
CN 曲线锯

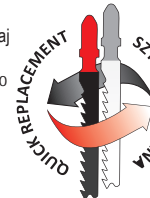

$L_{pa} = 80,9 \pm 3,0$ dB;
 $L_{wb} = 91,9 \pm 3,0$ dB;
 $a_s = 13,2 \pm 1,5 / 13,8 \pm 1,5$ m/s²

YATO	W	
YT-82270	550	5

- GB Jig saw
D Stichsäge
PL Wyrzynarka
RUS Электрический лобзик
CZ Přímočará pila
H Szűrőfűrész

- RO Ferăstrău pt. traforaj
F Scie sauteuse
I Seghetto alternativo
E Sierra de calar
CN 曲线锯



$L_{pa} = 80,9 \pm 3,0$ dB;
 $L_{wb} = 91,9 \pm 3,0$ dB;
 $a_s = 13,2 \pm 1,5 / 13,8 \pm 1,5$ m/s²

YATO	W	
YT-82272	750	5

- GB Electric planer
D Elektroholer
PL Strug elektryczny
RUS Электрорубанок
CZ Elektrický hoblík
H Elektromos gyaly

- RO Rindea electrica
F Rabot
I Piiala elettrica
E Garlopa electrica
CN 电刨

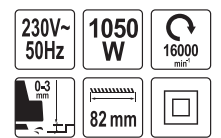

$L_{pa} = 92,0 \pm 3,0$ dB;
 $L_{wb} = 103,0 \pm 3,0$ dB;
 $a_s = 4,31 \pm 1,5$ m/s²

YATO	W	
YT-82140	1050	4

- GB Sabre saw
D Stichsägee
PL Pila szablasta
RUS Сабельная пила
CZ Šavlová pila
H Szablyafűrész
RO Ferăstrău electric

- F Scie sabre
I Sega elettrica alternativa
E Serra de sabre
CN 往复锯

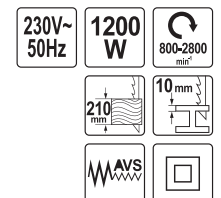

$L_{pa} = 83,9 \pm 3,0$ dB;
 $L_{wb} = 94,9 \pm 3,0$ dB;
 $a_s = 15,2 \pm 1,5$ m/s²



YATO	W	
YT-82280	1200	4

- GB Finishing sander
- D Schwiingschleifer
- PL Szlifierka oscylacyjna
- RUS Виброшлифмашина
- CZ Oscilační bruska
- H Vibrációs csiszológép
- RO Polizor oscilant
- F Ponceuse vibrante
- I Levigatrice orbitale
- E Lijadora de oscilación
- CN 砂光机

230V~50Hz 260 W

GRIT / ZIARNISTOŚĆ: 60, 80, 100, 120, 180, 240

13000 min⁻¹



COLOR BOX

L_{pa} = 82,0 ± 3,0 dB;
L_{wa} = 93,0 ± 3,0 dB;
a_h = 5,4 ± 1,5 m/s²

YATO	W	
YT-82230	260	4

- GB Drywall sander
- D Wandschleifer
- PL Szlifierka do tynków
- RUS Шлифмашина
- CZ Bruska muriva
- H Kézi csiszológép fal
- RO De perete manual slefuitor

- F Ponceuse a plaque filaire
- I Levigatrice per intonaco
- E Lijadora virutex pared manual
- CN 干墙打磨机

230V~50Hz 1220 W

GRIT / ZIARNISTOŚĆ: 60, 80, 100, 120, 180, 240

1500-2300 min⁻¹



COLOR BOX

L_{pa} = 85,0 ± 3,0 dB;
L_{wa} = 96,0 ± 3,0 dB;
a_h = 4,83 ± 1,5 m/s²

YATO	W	
YT-82340	1220	2



- GB Multi-purpose oscillating tool
- D Multifunktionales Oszillationswerkzeug
- PL Wielofunkcyjne narzędzie oscylacyjne
- RUS Многофункциональный инструмент
- CZ Multifunkční oscilační nářadí
- H Multifunkciós rezgő szerszám
- RO Unealtă multifuncțională oscilantă
- F Outil multifonctions oscillant
- I Oscillante strumento multifunzione
- E Herramienta oscilatoria multiusos
- CN 多功能啊雄莓



10.8 V Li-Ion

5000-15000 min⁻¹ 1h QUICK CHARGING SYSTEM

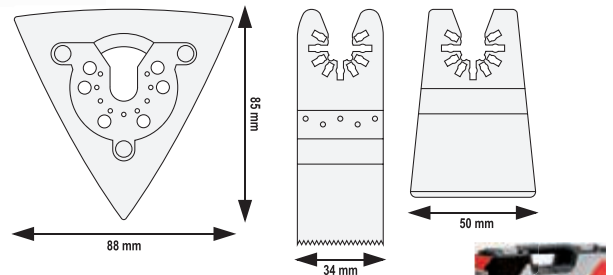

additional battery in set
dodatkowy akumulator
w zestawie

L_{pa} = 78,20 ± 3,0 dB;
L_{wa} = 89,20 ± 3,0 dB;
a_h = 1,609 ± 1,5 / 2,503 ± 1,5 m/s²

YATO	V	
YT-82900	10.8	5

- GB Multi-purpose oscillating tool
- D Multifunktionales Oszillationswerkzeug
- PL Wielofunkcyjne narzędzie oscylacyjne
- RUS Многофункциональный инструмент
- CZ Multifunkční oscilační nářadí
- H Multifunkciós rezgő szerszám
- RO Unealtă multifuncțională oscilantă
- F Outil multifonctions oscillant
- I Oscillante strumento multifunzione
- E Herramienta oscilatoria multiusos
- CN 多功能啊雄莓

- I Oscillante strumento multifunzione
- E Herramienta oscilatoria multiusos
- CN 多功能啊雄莓

230V~50Hz 300 W

15000-22000 min⁻¹

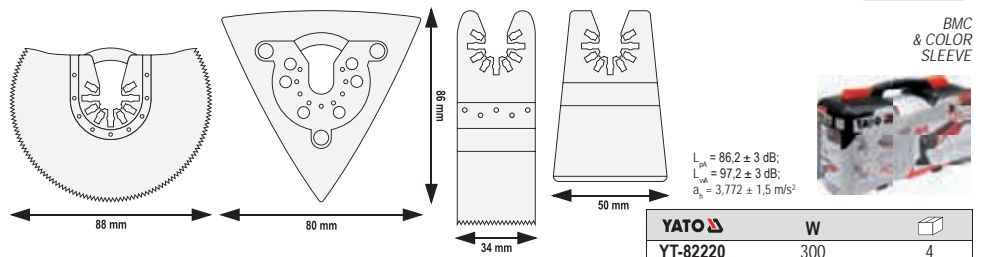
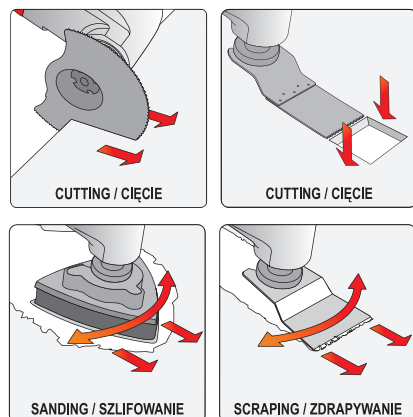
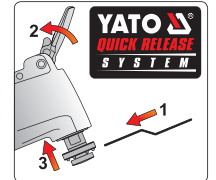

L_{pa} = 86,2 ± 3 dB;
L_{wa} = 97,2 ± 3 dB;
a_h = 3,772 ± 1,5 m/s²

YATO	W	
YT-82220	300	4

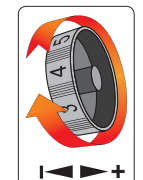

GB Multi-purpose oscillating tool
D Multifunktionales Oszillationswerkzeug
PL Wielefunkcyjne narzędzie oscylacyjne
RUS Многофункциональный инструмент

CZ Multifunkční oscilační nářadí
H Multifunkciós rezgő szerszám
RO Unealtă multifuncțională oscilantă
F Outil multifonctions oscillant

I Oscillante strumento multifunzione
E Herramienta oscilatoria multiusos
CN 多功能啊雄莓

230~240V~
50 Hz

500
W

8000~16000
mm

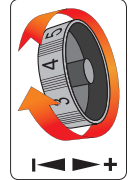
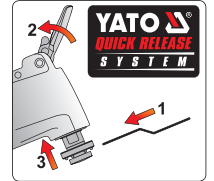

BMC
& COLOR
SLEEVE



YATO	W	
YT-82223	500	5

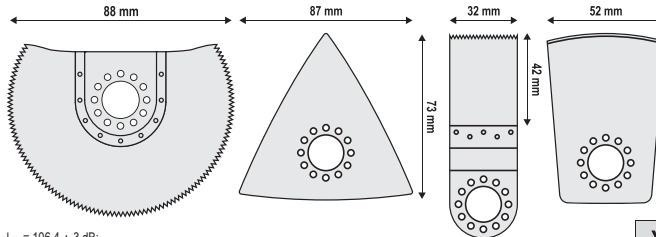
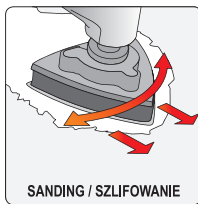
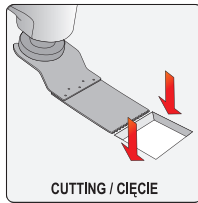
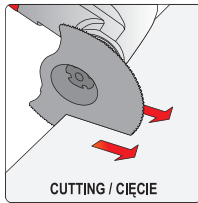

$L_{pA} = 106,4 \pm 3$ dB;
 $L_{pM} = 117,4 \pm 3$ dB;
 $a_b = 12,71 \pm 1,5$ m/s²

GB Thermal knife for polystyrene foam
D Thermomesser für Styropor
PL Nóż termiczny do styropianu
RUS Термонож для пенопласта
CZ Termický nůž na pěnový polystyrén
H Polisztirol vágó hőkés
RO Cuițit termic pt. stiropian
F Couteau thermique à styrofoam
I Coltello termico per polistirolo
E Cuchilla térmica para poliestireno
CN 热切割刀



230V~
50Hz

220
W

70~450
°C



COLOR BOX



YATO	W	L (mm)	
YT-82190	220	220	10

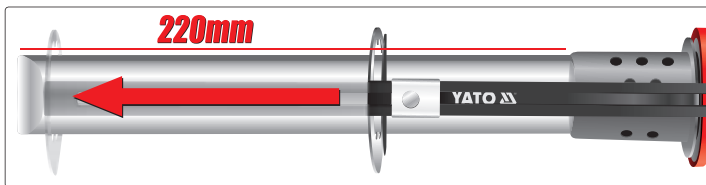
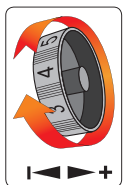

GB Hot air gun
D Heissluftpistole
PL Opalarka
RUS Фен для обжигания краски
CZ Opalovací stroj

H Hőlégfúvó
RO Fion pt. ars vopseaua
F Décapeur thermique
I Generatore aria calda
E Secadora
CN 热风枪

230V~
50Hz

2000
W

550°C

500
l/min

GB Hot air gun with accessories
D Heissluftpistole
PL Opalarka z akcesoriami
RUS Фен для обжигания краски в наборе
CZ Opalovací stroj s příslušenstvím
H Hőlégfúvó tartozékokkal
RO Fion cu accesorii pt. ars vopseaua
F Décapeur thermique
I Generatore aria calda con accessori
E Secadora con accesorios
CN 热风枪

230V~
50Hz

2000
W

550°C

500
l/min



COLOR BOX



YATO	W	
YT-82288	2000	10



BMC
& COLOR
SLEEVE



YATO	W	
YT-82291	2000	5

- GB Hot air gun with accessories
- D Heissluftpistole
- PL Opalarka z akcesoriami
- RUS Фен для обжигания краски в наборе
- CZ Opalovací stroj s příslušenstvím
- H Hőlégfúvó tartozékokkal
- RO Fion cu accesorii pt. ars vopsea
- F Décapeur thermique
- I Generatore aria calda con accessori
- E Secadora con accesorios
- CN 热风枪

230V~50Hz	2000 W	TEMPERATURE ADJUSTMENT
550°C	500 l/min	
LED		REGULACJA TEMPERATURY





BMC & COLOR SLEEVE

YATO	W	
YT-82292	2000	5

- GB Hot air gun with accessories
- D Heissluftpistole
- PL Opalarka z akcesoriami
- RUS Фен для обжигания краски в наборе
- CZ Opalovací stroj s příslušenstvím
- H Hőlégfúvó tartozékokkal
- RO Fion cu accesorii pt. ars vopsea
- F Décapeur thermique
- I Generatore aria calda con accessori
- E Secadora con accesorios
- CN 热风枪

230V~50Hz	2000 W	TEMPERATURE ADJUSTMENT
600°C	500 l/min	
LCD DISPLAY WYŚWIETLACZ		REGULACJA TEMPERATURY





BMC & COLOR SLEEVE

YATO	W	
YT-82293	2000	5

- GB Gas torch
- D Gasbrenner
- PL Palnik gazowy
- RUS Газовая паяльная лампа
- CZ Plynový hořák
- H Gázégő
- RO Arzător de gaz
- F Brûleur à gaz
- I Saldatore bruciatore a gas
- E Soplete de gas
- CN 火焰枪

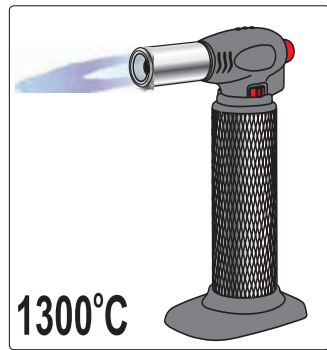

PIEZO	30 ml	60-90 min	GAS GAZ
LOCK BLOKADA	BUTANE lighter gas BUTAN (gas do zapalniczki)	CHILD PROTECTION ZABEZPECZENIE PRZED DZIECIAMI	



1300°C

DOUBLE BLISTER

YATO		
YT-36700		10/20

- GB Soldering tool set
- D Gaslötkolben satz
- PL Lutownica gazowa z akcesoriami
- RUS Газовый паяльный набор
- CZ Plynová pajka souprava
- H Gaz forrasztópaka készletek
- RO Set ciocan de lipit cu gaz
- F Fer à souder à gaz
- I Saldatore a gas
- E Soldador a gas con accesorios
- CN 自动点火多功能瓦斯组套

SOLDERING IRON	
LUTOWNICA	450°C

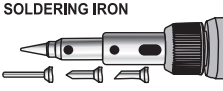

HOT AIR GUN	
OPALARKA	600°C

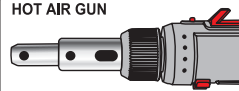

TORCH	
PALNIK	1300°C

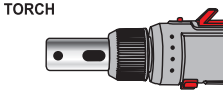

7 PCS	30-125 W	30 ml	75 min
GAS GAZ	PIEZO	LOCK BLOKADA	BUTANE lighter gas BUTAN (gas do zapalniczki)
PROPANE-BUTANE lighter gas PROPAN-BUTAN (gas do zapalniczki)	CHILD PROTECTION ZABEZPECZENIE PRZED DZIECIAMI		

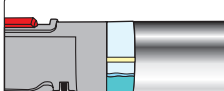
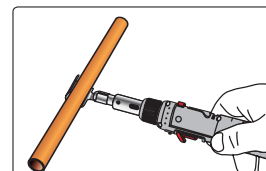

GAS LEVEL INSPECTION WINDOW	KONTROLA POZIOMU GAZU
-----------------------------	-----------------------

PLASTIC BOX & HANGING COLOR BOX

YATO	W	
YT-36706	30-125	6

- GB Soldering tool 3 in 1
D Gasłótkolben 3 in 1
PL Lutownica gazowa 3 w 1
RUS Газовый паяльник 3-в-1
CZ Plynová pájka 3 in 1
H Gaz-forrasztópaka 3 in 1
RO Ciocan de lipit cu gaz 3 in 1
F Fer à souder à gaz
I Saldatore a gas
E Soldador de gas 3 in 1
CN 瓦斯焊接工具



PIEZO	30~70 W	12 ml	60 min	GAS GAZ
LOCK BLOKADA	BUTANE lighter gas BUTAN (gas do zapalniczki)	PROPANE-BUTANE lighter gas PROPAN-BUTAN (gas do zapalniczki)	CHILD PROTECTION ZABEZPECZENIE PRZED DZIECIAMI	

SOLDERING IRON
LUTOWNICA 350°C

HOT AIR GUN
OPALARKA 550°C

TORCH
PALNIK 1300°C

GAS LEVEL INSPECTION WINDOW
KONTROLA POZIOMU GAZU

SLIDING CARD

YATO	W	
YT-36704	30-70	12/72

- GB Gas blow torch
D Lötbrenner
PL Palnik gazowy
RUS Газовая горелка
- CZ Plynový hořák
H Gázégő
RO Arzător de gaz
F Bruleur à gaz
- I Saldatore bruciatore a gas
E Soplete de gas
CN 火焰枪

PIEZO	1.28 kW	GAS GAZ	AIR POWIETRZE	LOCK BLOKADA	BUTANE BUTAN
-------	---------	---------	---------------	--------------	--------------

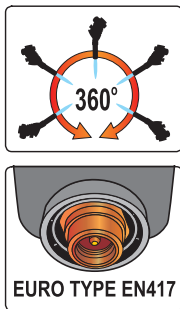
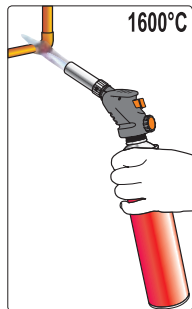

SLIDING CARD

YATO	kW	
YT-36709	1.28	6/12

- GB Soldering iron
D LötKolben
PL Lutownica odporowa
RUS Электропаяльник
CZ Pájka odporová
H Forrasztópáka
RO Ciocan de lipit
F Fer à souder
I Saldatore a stagno
E Soldador de resistencia
CN 电烙铁



HANGING DISPLAY COLOR BOX

YATO	W	max. temperature of soldering tip / max. temperatura grotu (°C)	dimensions of soldering tip / wymiary grotu (mm)	
YT-8271	30	400	ø3.8 x 70	16
YT-8272	60	500	ø6.0 x 78	16
YT-8273	80	520	ø6.8 x 64	16

- GB Transformer soldering gun
D Lötpestole
PL Lutownica transformatorowa
RUS Паяльник электрический
CZ Transformátorová páječka
H Forrasztópáka
RO Aparat de lipid letcon cu transformator
F Fer à souder
- I Saldatore istantaneo
E Soldador transformador
CN 电烙铁

230V~50Hz 180 W

WORKING MODE TRYB PRACY S2 20%

LED

- GB Transformer soldering gun
D Lötpestole
PL Lutownica transformatorowa
RUS Паяльник электрический
CZ Transformátorová páječka
H Forrasztópáka
RO Aparat de lipid letcon cu transformator
F Fer à souder
- I Saldatore istantaneo
E Soldador transformador
CN 电烙铁

230V~50Hz LED

200 W

351-500°C 201-300°C 70-200°C



WORK LIGHT OŚWIETLENIE PRACY

YATO	W	
YT-8245	180	10



WORK LIGHT OŚWIETLENIE PRACY

YATO	W	
YT-82451	200	10

- GB Soldering station
- D Lötstation
- PL Stacja lutownicza
- RUS Паяльная станция
- CZ Letovací stanice
- H Forrasztópáka állomás
- RO Stație de lipit
- F Station de soudage
- I Stazione digitale di saldatura
- E Estación de soldadura
- CN 数显焊台



230V~50Hz	48W	150-450°C
7.1 mm 65 mm	LCD DISPLAY WYSWIETLACZ	1°C



YATO	W	
YT-82455	48	4

- GB Electric glue gun
- D Heissklebepistole
- PL Pistolet do klejenia
- RUS Пистолет для клея
- CZ Pistole na lepení
- H Ragasztópisztoly

- RO Pistol pt. lipit
- F Pistolet à colle
- I Pistola colla
- E Pistola de cola
- CN 热胶枪

230V~50Hz	35 (400) W	150-200°C	15 g/min
3-6 min	11 mm		

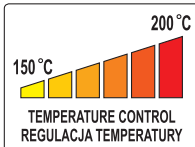

YATO	W	diameter of glue stick średnica wkładu (mm)	capacity wydajność (g/min)	
YT-82401	35 (400)	11	15	12/24

- GB Electric glue gun
- D Heissklebepistole
- PL Pistolet do klejenia
- RUS Пистолет для клея
- CZ Pistole na lepení
- H Ragasztópisztoly

- RO Pistol pt. lipit
- F Pistolet à colle
- I Pistola colla
- E Pistola de cola
- CN 热胶枪

230V~50Hz	20 (80) W	180-200°C	15 g/min
3-5 min	3x 11mm		



YATO	W	diameter of glue stick średnica wkładu (mm)	capacity wydajność (g/min)	
YT-82402	20 (80)	11	15	12/48

- GB PVC plastic pipe welder
- D Schweissgerät für thermoplastische Rohre
- PL Zgrzewarka do rur termoplastycznych
- RUS Сварочная машина для термопластиковых труба
- CZ Svářečka na termoplastické trubky
- H Hegesztő berendezés termoplasztikus csövekhez

- RO Masina de sudat tevi termoplastice
- F Soudeur en tuyauterie en PVC
- I Polifusore saldatore per tubi
- E Máquina de soldar las tubos termoplásticos
- CN 热熔器

230V~50Hz	850 W	0-300°C	16, 20, 25, 32 (mm)	40, 50, 63
-----------	-------	---------	---------------------	------------



YATO	W	
YT-82250	850	2

GB Gasoline generator
D Stromgenerator
PL Generator prądowórczy
RUS Генератор тока
CZ Generátor vytvářející proud
H Áramfejlesztő generátorhoz
RO Generator de curent
F Groupe électrogène
I Generatore di corrente
E Generator de corriente
CN 发电机



230V-50Hz
2x

3.2 kW

242 cm³

25 l

13.9 A

EASY START
LÁTVY
ROZRUCH



• spare parts available
• dostępne części zamienne

$L_{pA} = 74,2 \pm 2,23$ dB;
 $L_{wA} = 93,4 \pm 2,23$ dB

GREY
CARTON BOX
& COLOR
LABEL

YATO	kW	
YT-85434	3.2	1

GB Gasoline generator
D Stromgenerator
PL Generator prądowórczy
RUS Генератор тока
CZ Generátor vytvářející proud
H Áramfejlesztő generátorhoz
RO Generator de curent
F Groupe électrogène
I Generatore di corrente
E Generator de corriente
CN 发电机



230V-50Hz
2x

4.0 kW

389 cm³

25 l

17.4 A

EASY START
LÁTVY
ROZRUCH



• spare parts available
• dostępne części zamienne

$L_{pA} = 74,7 \pm 1,91$ dB;
 $L_{wA} = 94,5 \pm 2,23$ dB

GREY
CARTON BOX
& COLOR
LABEL

YATO	kW	
YT-85437	4.0	1

GB Gasoline water pump
D Pumpe mit verbrennungsmotor
PL Pompa spalinowa
RUS Бензонасос
CZ Čerpadlo
se spalovacím motorem
H Robbanómotoros szivattyú
RO Pompa cu motor
cu ardere interna
F Pompe à eau
I Motopompa
E Bomba de combustion
CN 汽油抽水泵

3.6 kW

3600 min⁻¹

196 cm³

50mm 2"

Q_{MAX} 500 l/min

Q_{MAX} 30m³/h

25 m

8 m

3.6 l

GB Gasoline water pump
D Pumpe mit verbrennungsmotor
PL Pompa spalinowa
RUS Бензонасос
CZ Čerpadlo
se spalovacím motorem
H Robbanómotoros szivattyú
RO Pompa cu motor
cu ardere interna
F Pompe à eau
I Motopompa
E Bomba de combustion
CN 汽油抽水泵

3.6 kW

3600 min⁻¹

196 cm³

80mm 3"

Q_{MAX} 800 l/min

Q_{MAX} 50m³/h

20 m

8 m

3.6 l

GB Gasoline water pump
D Pumpe mit verbrennungsmotor
PL Pompa spalinowa
RUS Бензонасос
CZ Čerpadlo
se spalovacím motorem
H Robbanómotoros szivattyú
RO Pompa cu motor
cu ardere interna
F Pompe à eau
I Motopompa
E Bomba de combustion
CN 汽油抽水泵

4.0 kW

3600 min⁻¹

208 cm³

100mm 4"

Q_{MAX} 1300 l/min

Q_{MAX} 78m³/h

20 m

8 m

3.6 l



$L_{pA} = 82,1 \pm 3,0$ dB;
 $L_{wA} = 95,4 \pm 3,0$ dB

BROWN CARTON BOX
& COLOR LABEL

YATO		
YT-85401		1



$L_{pA} = 81,9 \pm 3,0$ dB;
 $L_{wA} = 95,0 \pm 3,0$ dB

BROWN CARTON BOX
& COLOR LABEL

YATO		
YT-85402		1



$L_{pA} = 81,9 \pm 3,0$ dB;
 $L_{wA} = 94,9 \pm 3,0$ dB

BROWN CARTON BOX
& COLOR LABEL

YATO		
YT-85403		1

- GB Submersible pump for dirty water and wastewater
- D Tauchpumpe für Schmutzwasser
- PL Pompa zatapialna do wody brudnej i ścieków
- RUS Погружной насос для грязной воды
- CZ Ponorové čerpadlo pro odpadní vody
- H Búvárszivattyú szennyvíz
- RO Pompa submersibilă pt. apă uzată
- F Pompe submersible pour eaux usees
- I Pompa sommersa per acque reflue
- E Bomba sumergible para aguas residuales
- CN 污水和废水的潜水泵



230V~50Hz 750 W Q max 16000 l/h

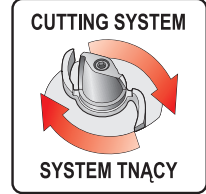

Δ [m]	Q [l/h]
0	16000
1	15000
2	14000
3	13500
4	12500
5	11500
6	11000
7	10500
8	9500
9	8000
10	5500
11	3500
12	2000
13	500

COLOR BOX



YATO	W	l / h	H (max)	
YT-85350	750	16000	13	1

- GB Cordless chainsaw
- D Akku-kettensäge
- PL Akumulatorowa pilarka łańcuchowa
- RUS Аккумуляторная цепная пила
- CZ Akumulátorová řetězová píla
- H Akkus láncfűrész
- RO Ferăstrăie cu lanț cu acumulator
- F Tronçonneuse
- I Motosega a batteria
- E Inalámbrico motosierra
- CN 无线链锯



40 V 2.5 Ah 12" 30.5 cm Li-Ion

AUTOMATIC CHAIN LUBRICATION
AUTOMATYCZNE SMAROWANIE ŁĄCZKI NAPĘDZAJĄCEJ

TOOL-FREE ADJUSTMENT OF CHAIN TENSION
BEZNAKLĘPNEGO REGULACJA NAPĘDZAJĄCEJ

CHARGE LEVEL INDICATOR
WSKAZNIK STANU NAŁADOWANIA BATERII

OIL TANK 0.18 l

COLOR BOX



L_{pa} = 86.8 ± 3.0 dB;
L_{pa} = 96.5 ± 3.0 dB;
a_{wa} = 3.5 ± 1.5 m/s²

YATO	V	
YT-85090	40	2

- GB Battery
- D Akkumulator
- PL Akumulator
- RUS Аккумулятор
- CZ Akumulátor
- H Akkumulátor
- RO Acumulatorul
- F Batterie
- I Batteria
- E Bateria
- CN 锂电池



WHITE CARTON BOX & COLOR LABEL



for / dla: YT-85090

YATO	V	
YT-85132	40	10

- GB Battery charger
- D Ladegerät
- PL Ładowarka
- RUS Зарядное устройство
- CZ Nabíječka
- H Akkutöltő
- RO Redresor
- F Chargeur de batterie
- I Caricabatteria
- E Rectificador
- CN 充电器



WHITE CARTON BOX & COLOR LABEL



for / dla: YT-85090, YT-85132

YATO	V	
YT-85133	40	18

- GB Cordless chainsaw
- D Akku-kettensäge
- PL Akumulatorowa pilarka łańcuchowa
- RUS Аккумуляторная цепная пила
- CZ Akumulátorová řetězová píla
- H Akkus láncfűrész
- RO Ferăstrăie cu lanț cu acumulator
- F Tronçonneuse
- I Motosega a batteria
- E Inalámbrico motosierra
- CN 无线链锯



18 V 3.0 Ah 10" 25 cm Li-Ion

AUTOMATIC CHAIN LUBRICATION
AUTOMATYCZNE SMAROWANIE ŁĄCZKI NAPĘDZAJĄCEJ

OIL TANK 0.21 l

COLOR BOX



L_{pa} = 80.8 ± 3.0 dB;
L_{pa} = 93.6 ± 3.68 dB;
a_{wa} = 2.53 ± 1.5 / 3.80 ± 1.5 m/s²

YATO	V	
YT-85080	18	2

- GB Cordless pole saw
D Akku-Hochentaster
PL Akumulatorowa okrzesywarka na wysięgniku
RUS Аккумуляторный телескопический высоторез
CZ Akumulátorová vyvėtvovací pila
H Akkus magassági ágvasó távcsőves
RO Ferăstraie cu lanț cu telescopic
F Elagueuse sur perche
I Potatore a batteria
E Sierra de pértiga telescópica
CN 高枝锯



18 V 3.0 Ah 8" / 20 cm
Li-Ion
AUTOMATIC CHAIN LUBRICATION
AUTOMATYCZNE SMAROWANIE łańcucha tnącego
TOOL-FREE ADJUSTMENT OF CHAIN TENSION
BEZINSTRUMENTOWA REGULACJA napięcia łańcucha tnącego
OIL TANK 0.6 l

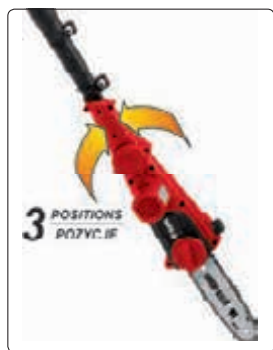

$L_{pa} = 78.8 \pm 3.0$ dB;
 $L_{wa} = 90.7 \pm 2.36$ dB;
 $a_s = 2.68 \pm 1.5 / 4.84 \pm 1.5$ m/s²

YATO	V	
YT-85120	18	2

- GB Cordless telescopic pole saw
D Akku-Teleskop-Hochentaster
PL Akumulatorowe okrzesywarka na wysięgniku
RUS Аккумуляторный телескопический высоторез
CZ Akumulátorová teleskopická vyvėtvovací pila
H Akkus magassági ágvasó távcsőves
RO Ferăstraie cu lanț cu telescopic cu acumulator
F Elagueuse sur perche telescopique sans-fil
I Decescpuigliatore telescopico a batteria
E Sierra de pértiga telescópica a batería
CN 充电式高枝锯



$L_{pa} = 78.2 \pm 3.0$ dB;
 $L_{wa} = 91.2 \pm 2.36$ dB;
 $a_s = 2.109 \pm 1.5$ m/s²

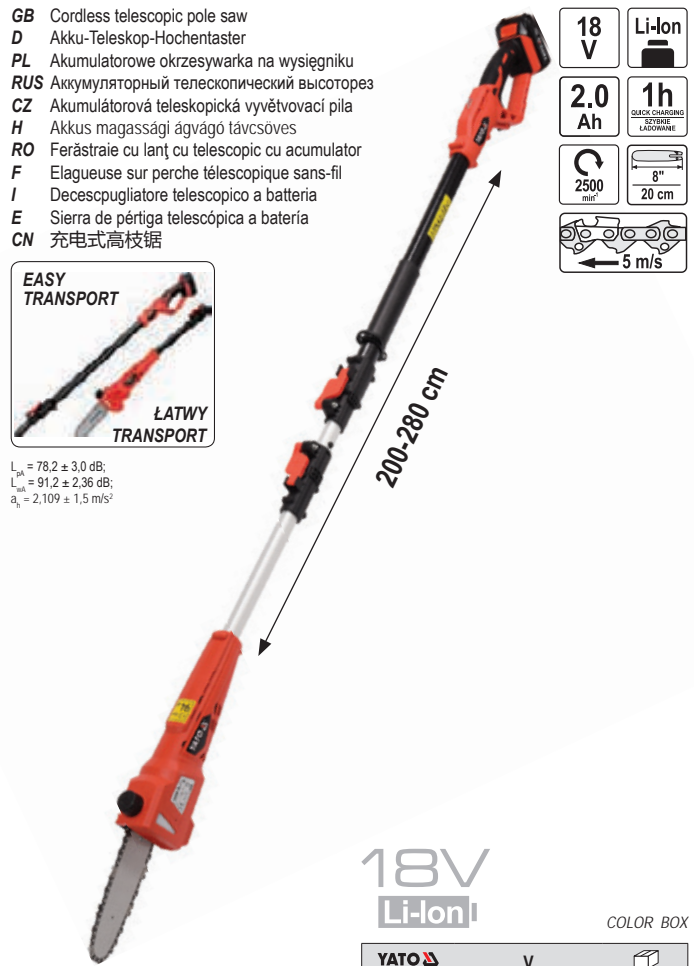

18 V Li-Ion
2.0 Ah 1h QUICK CHARGING SYSTEM ŁADOWANIE
2500 min⁻¹ 8" / 20 cm
5 m/s

18V
Li-Ion

COLOR BOX

YATO	V	
YT-82836	18	2

- GB Cordless telescopic pole saw (tool only)
D Akku-Teleskop-Hochentaster (nur das Gerät)
PL Akumulatorowe okrzesywarka na wysięgniku (tylko narzędzie)
RUS Аккумуляторный телескопический высоторез (только инструмент)
CZ Akumulátorová teleskopická vyvėtvovací pila (pouze nářadí)
H Akkus magassági ágvasó távcsőves (csak a szerszámot)
RO Ferăstraie cu lanț cu telescopic cu acumulator (numai sculă)
F Elagueuse sur perche telescopique sans-fil (outil seulement)
I Decescpuigliatore telescopico a batteria (solo utensile)
E Sierra de pértiga telescópica a batería (herramienta solamente)
CN 充电式高枝锯 (光机)



$L_{pa} = 78.2 \pm 3.0$ dB;
 $L_{wa} = 91.2 \pm 2.36$ dB;
 $a_s = 2.109 \pm 1.5$ m/s²



18 V Li-Ion 2500 min⁻¹
1h* QUICK CHARGING SYSTEM ŁADOWANIE
8" / 20 cm
5 m/s

18V
Li-Ion

battery not included
akumulatura
nie dołączono

COLOR BOX

YATO	V	
YT-82837	18	2

* given charging time is for 2.0 Ah battery only
* podany czas ładowania dotyczy tylko akumulatora 2.0 Ah

- GB Cordless grass trimmer
D Akku-Rasentrimmer
PL Akumulatorowa podkaszarka do trawy
RUS Аккумуляторный телескопический высоторез
CZ Akumulátorová sekačka na trávu
H Akkus szegélynyíró
RO Trimmer de gazon cu acumulator
F Coupe bordures sans fil
I Tosaerba a filo a batteria
E Desmalezadora inalámbrica
CN 打草机



$L_{pa} = 80.8 \pm 3.0$ dB;
 $L_{wa} = 88.5 \pm 2.64$ dB;
 $a_s = 4.41 \pm 1.5 / 3.33 \pm 1.5$ m/s²

18 V 3.0 Ah 8800 min⁻¹ Li-Ion 250 mm

YATO	V	
YT-85110	18	4

- GB** Cordless grass trimmer
D Akku-Rasentrimmer
PL Akumulatorowa podkaszarka do trawy
RUS Аккумуляторный триммер
CZ Akumulátorová sekačka na trávu
H Akkus szegélynyíró
RO Trimmer de gazon cu acumulator
F Débroussailluse sans-fil
I Tagliabordi a batteria
E Desbrozadora a batería
CN 充电式打草机

18 V Li-Ion 7200 min* 2.0 Ah 1h QUICK CHARGING SYSTEM SZYBIEJ LADOWANIE 250/300 mm



$L_{pA} = 85.0 \pm 3.0$ dB;
 $L_{wA} = 93.0 \pm 3.0$ dB;
 $a_s = 2.5 \pm 1.5$ m/s²

YATO	V	
YT-82830	18	2

18V Li-Ion

COLOR BOX

- GB** Cordless grass trimmer (tool only)
D Akku-Rasentrimmer (nur das Gerät)
PL Akumulatorowa podkaszarka do trawy (tylko narzędzie)
RUS Аккумуляторный триммер (только инструмент)
CZ Akumulátorová sekačka na trávu (pouze nářadí)
H Akkus szegélynyíró (csak a szerszámot)
RO Trimmer de gazon cu acumulator (numai sculă)
F Débroussailluse sans-fil (outil seulement)
I Tagliabordi a batteria (solo utensile)
E Desbrozadora a batería (herramienta solamente)
CN 充电式打草机 (光机)

18 V Li-Ion 7200 min* 1h* QUICK CHARGING SYSTEM SZYBIEJ LADOWANIE 250/300 mm



$L_{pA} = 85.0 \pm 3.0$ dB;
 $L_{wA} = 93.0 \pm 3.0$ dB;
 $a_s = 2.5 \pm 1.5$ m/s²

YATO	V	
YT-82831	18	2

18V Li-Ion

COLOR BOX

battery not included
 akumulatora nie dołączono

* given charging time is for 2.0 Ah battery only

* podany czas ładowania dotyczy tylko akumulatora 2.0 Ah

- GB** Cordless hedge trimmer
D Akku-Heckenschere
PL Akumulatorowe nożyce do żywopłotu
RUS Аккумуляторный кусторез
CZ Akumulátorové nůžky na živé ploty
H Akkus sövénynyíró
RO Foarfece de tăiat gard viu cu acumulator
F Taille-haies sans fil

- I** Tagliasiepi a batteria
E Cortasetos inalámbrico
CN 充电式修枝剪



$L_{pA} = 77.4 \pm 3.0$ dB;
 $L_{wA} = 86.5 \pm 2.07$ dB;
 $a_s = 1.96 \pm 1.5 / 2.07 \pm 1.5$ m/s²

YATO	V	
YT-85100	18	2



COLOR BOX

18 V 3.0 Ah Li-Ion 2400 min* 450mm

- GB** Cordless hedge trimmer (tool only)
D Akku-Heckenschere (nur das Gerät)
PL Akumulatorowe nożyce do żywopłotu (tylko narzędzie)
RUS Аккумуляторный кусторез (только инструмент)
CZ Akumulátorové nůžky na živé ploty (pouze nářadí)
H Akkus sövénynyíró (csak a szerszámot)
RO Foarfece de tăiat gard viu cu acumulator (numai sculă)
F Taille-haies sans fil (outil seulement)
I Tagliasiepi a batteria (solo utensile)
E Cortasetos inalámbrico (herramienta solamente)
CN 充电式高枝剪 (光机)

- I** Tagliasiepi a batteria
E Cortasetos inalámbrico
CN 充电式修枝剪



$L_{pA} = 80.0 \pm 3.0$ dB;
 $L_{wA} = 87.0 \pm 3.0$ dB;
 $a_s = 3.5 \pm 1.5$ m/s²

YATO	V	
YT-82832	18	2



COLOR BOX

18 V Li-Ion 2.0 Ah 1h QUICK CHARGING SYSTEM SZYBIEJ LADOWANIE 1050 min* 560 mm 22"

- GB** Cordless hedge trimmer (tool only)
D Akku-Heckenschere (nur das Gerät)
PL Akumulatorowe nożyce do żywopłotu (tylko narzędzie)
RUS Аккумуляторный кусторез (только инструмент)
CZ Akumulátorové nůžky na živé ploty (pouze nářadí)
H Akkus sövénynyíró (csak a szerszámot)
RO Foarfece de tăiat gard viu cu acumulator (numai sculă)
F Taille-haies sans-fil (outil seulement)
I Tagliasiepi a batteria (solo utensile)
E Cortasetos inalámbrico (herramienta solamente)
CN 充电式高枝剪 (光机)

- I** Tagliasiepi a batteria (solo utensile)
E Cortasetos inalámbrico (herramienta solamente)
CN 充电式高枝剪 (光机)



$L_{pA} = 80.0 \pm 3.0$ dB;
 $L_{wA} = 87.0 \pm 3.0$ dB;
 $a_s = 3.5 \pm 1.5$ m/s²

YATO	V	
YT-82833	18	2



COLOR BOX

18 V Li-Ion 1h* QUICK CHARGING SYSTEM SZYBIEJ LADOWANIE 1050 min* 560 mm 22"

battery not included
 akumulatora nie dołączono

* given charging time is for 2.0 Ah battery only

* podany czas ładowania dotyczy tylko akumulatora 2.0 Ah

18V Li-Ion

- GB Cordless hedge trimmer
D Akku-Heckenschere
PL Akumulatorowe nożyce do żywopłotu
RUS Аккумуляторный кусторез
CZ Akumulátorové nůžky na živé ploty
H Akkus sövénynyíró
RO Foarfece de tăiat gard viu cu acumulator
F Taille-haies sans-fil
I Tagliasiepi a batteria
E Tijera cortasetos a batería
CN 充电式高枝剪

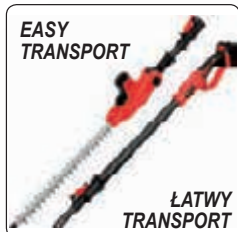

$L_{pA} = 77.3 \pm 3.0$ dB;
 $L_{wA} = 88.1 \pm 3.0$ dB;
 $a_p = 1.5 \pm 1.5$ m/s²

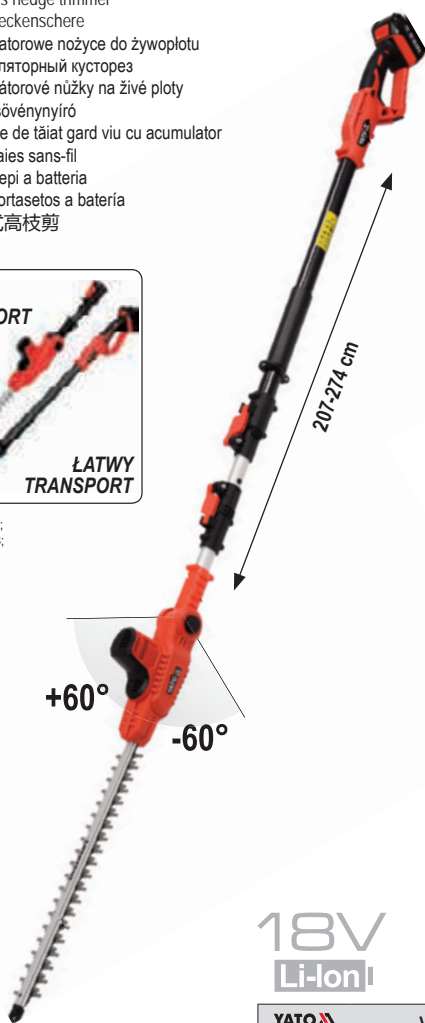

18V
Li-Ion

COLOR BOX

YATO	V	
YT-82834	18	2

- GB Cordless hedge trimmer (tool only)
D Akku-Heckenschere (nur das Gerät)
PL Akumulatorowe nożyce do żywopłotu (tylko narzędzie)
RUS Аккумуляторный кусторез (только инструмент)
CZ Akumulátorové nůžky na živé ploty (pouze nářadí)
H Akkus sövénynyíró (csak a szerszámot)
RO Foarfece de tăiat gard viu cu acumulator (numai scula)
F Taille-haies sans-fil (outil seulement)
I Tagliasiepi a batteria (solo utensile)
E Tijera cortasetos a batería (herramienta solamente)
CN 充电式高枝剪 (光机)

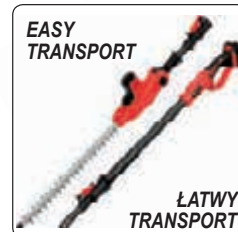
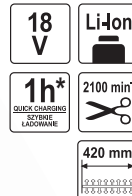

$L_{pA} = 77.3 \pm 3.0$ dB;
 $L_{wA} = 88.1 \pm 3.0$ dB;
 $a_p = 1.5 \pm 1.5$ m/s²

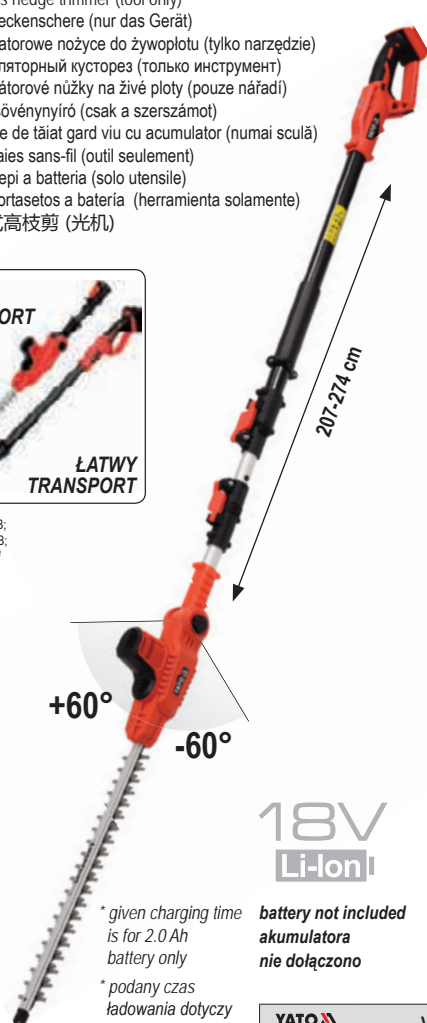

18V
Li-Ion

* given charging time is for 2.0 Ah battery only

battery not included
akumulatora
nie dołączono

* podany czas ładowania dotyczy tylko akumulatora 2.0 Ah

COLOR BOX

YATO	V	
YT-82835	18	2

- GB Battery
D Akkumulator
PL Akumulator
RUS Аккумулятор
CZ Akumulátor
H Akumulátor
RO Acumulatorul
F Batterie
I Batteria
E Bateria
CN 锂电池

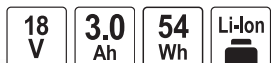

WHITE CARTON BOX & COLOR LABEL

for / dla: YT-85080, YT-85100, YT-85110, YT-85120

YATO	V	
YT-85130	18	18

- GB Battery charger
D Ladegerät
PL Ładowarka
RUS Зарядное устройство
CZ Nabíječka
H Akkutöltő
RO Redresor
F Chargeur de batterie
I Caricabatteria
E Rectificador
CN 充电器



WHITE CARTON BOX & COLOR LABEL

for / dla: YT-85080, YT-85100, YT-85110, YT-85120, YT-85130

YATO	V	
YT-85131	18	27

- GB Battery
D Akkumulator
PL Akumulator
RUS Аккумулятор
CZ Akumulátor
H Akumulátor
RO Acumulatorul
F Batterie
I Batteria
E Bateria
CN 锂电池



COLOR BOX

for / dla: YT-82830, YT-82831, YT-82832, YT-82833, YT-82834, YT-82835, YT-82836, YT-82837

YATO	V	capacity / pojemność (Ah)	charging time / czas ładowania (h)	
YT-82842	18	2.0	1.0	20
YT-82843	18	3.0	1.5	20
YT-82844	18	4.0	2.0	20

- GB Battery charger
D Ladegerät
PL Ładowarka
RUS Зарядное устройство
CZ Nabíječka
H Akkutöltő
RO Redresor
F Chargeur de batterie
I Caricabatteria
E Rectificador
CN 充电器



COLOR BOX

for / dla: YT-82830, YT-82831, YT-82832, YT-82833, YT-82834, YT-82835, YT-82836, YT-82837

YATO	V	
YT-82848	18	8

- GB** Electric chainsaw
D Kettensäge
PL Piłarka elektryczna
RUS Электропила цепная
CZ Elektrická pila
H Elektromos fűrész
RO Ferăstrău cu lanț
F Tronçonneuse électrique
I Motosega elettrica
E Motosierra eléctrica
CN 电链锯

2.2 kW 230V~50Hz 16" / 40 cm

AUTOMATIC CHAIN LUBRICATION
 AUTOMATYCZNE SMAROWANIE ŁUKADŁU (TRACEDŁO)
 TOOL-FREE ADJUSTMENT OF CHAIN TENSION
 BEZKŁUCZKOWA REGULACJA NAPĘSIWAJĄCOŚCI
 OIL TANK 0.23 l



COLOR BOX

L_{pa} = 87.5 ± 0.88 dB;
 L_{pk} = 104.88 ± 0.88 dB;
 a_w = 4.552 ± 1.5 m/s²

YATO	kW	
YT-84920	2.2	2

- GB** Gasoline backpack sprayer
D Benzin Motorsprüher
PL Opryskiwacz plecakowy spalinowy
RUS Бензиновый ранец-опрыскиватель
CZ Motorový rosič
H Benzines permetező
RO Pulverizatoare pe benzina
F Pulvérisateur a essence
I Atomizzatore
E Pulverizador de gasolina
CN 喷雾喷粉机



2.13 kW / 2.9 KM 41.5 cm³ 12 m max ≤3 l/min 16 l



WHITE CARTON BOX & COLOR LABEL

L_{pa} = 78.8 ± 3.0 / 97.8 ± 3.0 dB;
 L_{pk} = 89.8 ± 3.0 / 108.8 ± 3.0 dB;
 a_w = 1.94 ± 1.5 / 8.93 ± 1.5 m/s²

YATO	kW	KM	
YT-85140	2.13	2.9	1

- GB** Gasoline chainsaw
D Motorsägen
PL Piłarka spalinowa
RUS Бензопила
CZ Motorová pila
H Benzin láncfűrész
RO Drujba pe benzina
F Tronçonneuses
I Motosega a benzina
E Motosierra de gasolina
CN 油锯



1.8 kW / 2.4 KM 45 cm³ 11000 min⁻¹ 18" / 44 cm

0.325" / 8.255 mm 0.058" / 1.5 mm

40 : 1 OIL TANK 0.26 l

Matching YATO bars / Pasujące prowadnice z programu YATO: YT-84934, YT-84936
 Matching YATO chains / Pasujące łańcuchy z programu YATO: YT-84940, YT-84941, YT-84942, YT-84943, YT-84944



QUICK CHANGE OF AIR FILTER
 ŁATWA WYMIANA FILTRA POWIETRZA

L_{pa} = 90.8 ± 2.5 dB;
 L_{pk} = 109.3 ± 2.5 dB;
 a_w = 6.815 ± 1.5 / 5.277 ± 1.5 m/s²

COLOR BOX



YATO	kW	KM	L (mm)	
YT-84900	1.8	2.4	440	1

- GB Gasoline chainsaw
D Motorsägen
PL Piłarka spalinowa
RUS Бензопила
CZ Motorová pila
H Benzin láncfűrész
RO Drujba pe benzina
F Tronçonneuses
I Motosega a benzina
E Motosierra de gasolina
CN 油锯



2.0 kW	49.3 cm ³	8500 min ⁻¹	AUTOMATIC CHAIN LUBRICATION AUTOMATYCZNE SMAROWANIE CIĄKIŁA ŁCIENIEGO	ANTIVIBRATION SYSTEM ANTYWIBRACYJNY	20"
2.7 KM					0.05"
					1.3 mm
					OIL TANK 40 : 1 0.26 l

Matching YATO bars / Pasujące prowadnice z programu YATO: YT-84933
Matching YATO chains / Pasujące łańcuchy z programu YATO: YT-84945

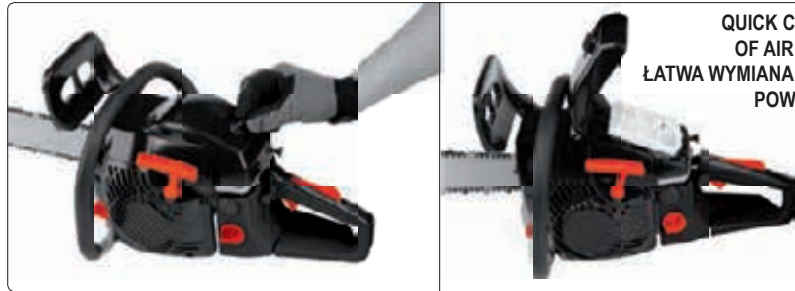

**QUICK CHANGE
OF AIR FILTER
ŁATWA WYMIANA FILTRA
POWIETRZA**

L_{pa} = 106.5 ± 3 dB;
L_{pa} = 114.4 ± 3 dB;
a_h = 6.9 ± 1.5 / 9.4 ± 1.5 m/s²

COLOR
BOX



YATO	kW	KM	L (mm)	Box
YT-84905	2.0	2.7	500	1

- GB Brushcutter
D Motorsensen
PL Kosa spalinowa
RUS Бензокоса
CZ Motorový křovinořez
H Motoros kasza
RO Motocoasa
I Falce fienaiia a benzina
E Motoguadaña de gasolina
CN 割草机



1.25 kW	42.7 cm ³
1.7 KM	
255 mm	430 mm
40 : 1	1L

L_{pa} = 88.59 ± 5.29 dB;
L_{pa} = 106.65 ± 5.29 dB;
a_h = 12.479 ± 1.5 / 4.692 ± 1.5 m/s²

COLOR
BOX

YATO	kW	KM	Box
YT-85000	1.25	1.7	1

- GB Brushcutter
D Motorsensen
PL Kosa spalinowa
RUS Бензокоса
CZ Motorový křovinořez
H Motoros kasza
RO Motocoasa
I Falce fienaiia a benzina
E Motoguadaña de gasolina
CN 割草机



1.4 kW	51.7 cm ³
1.9 KM	
255 mm	430 mm
40 : 1	1L

L_{pa} = 94.35 ± 2.5 dB;
L_{pa} = 108.67 ± 2.5 dB;
a_h = 4.512 ± 1.5 / 4.319 ± 1.5 m/s²

COLOR
BOX

YATO	kW	KM	Box
YT-85002	1.4	1.9	1

- GB Petrol hedge trimmer
D Benzin-Heckenscheren
PL Spalinowe nożyce do żywopłotu
RUS Бензоножницы
CZ Plotostřih na živé ploty
H Benzines sövényvágó

- RO Tuns gard viu
F Taille-haie
I Tosasiepi per privati
E Corta sebes a gasolina
CN 绿篱剪



0.7 kW	25.4 cm ³	7000 min ⁻¹	550mm
0.99 KM			
		1850 min ⁻¹	40 : 1
			0.6L

L_{pa} = 96 ± 3 dB;
L_{pa} = 105.3 ± 0.48 dB;
a_h = 6.9 ± 1.5 m/s²

COLOR
BOX

YATO	kW	KM	L (mm)	Box
YT-85021	0.7	0.99	550	1

- GB** Chainsaw guide bar
- D** Kettensägeführung
- PL** Prowadnica do pił łańcuchowych
- RUS** Шина для бензопил
- CZ** Vodičí lišta k řetězové pile
- H** Lánvezető
- RO** Lama de ghidai pt. ferastrau
- F** Guide de tronçonneuse
- I** Barra per motosega
- E** Barra guía motosierra
- CN** 导板

COLOR PAPER POUCH Mn 65



for / dla: YT-84950, YT-84960

competitors / odpowiedniki: Oregon: 140SPEA074; Alpina: 4112560; Stihl: 3005 000 809; Windsor: 14ST50SSR for / dla: Alpina: 270, 280, Elletra 160, Elletra 170, Energy 1.6, Energy 1.8, P360, P361, P370, P390, P391, Sinergy 35, Sinergy 40; Oleo-Mac: 240, OEM200; Stihl: 009, 010, 011, 012, 017, 018, 019, 019T, 020, 020T, 021, 021C, 023, 025, 25, MS160, MS170, MS180, MS181, MS191, MS192, MS200, MS200T, MS210, MS211, MS230, MS231, MS241, MS250, MS251, MSE140, MSE200

14" 36 cm	± 2 3/8" 9.32 mm	$\pm 0.322"$ 8.2 mm
50	0.05" 1.3 mm	4 RIVETS 4 NITY
ROLLER BEARING ŁOŻYSKO WALECZKOWE		
YATO size / rozmiar YT-84930 14" (36 cm) 20		



for / dla: YT-84951, YT-84960

competitors / odpowiedniki: Oregon: 140SDEA041; Oleo-mac: 50030218; Husqvarna: 501854149; Windsor: 14PKU50SSR; Makita: 442035661, 472035661, 482035661; Alpina: 4112300; Dolmar: 412035661, 452035661, 462035661; Partner: 530044328 for / dla: Al-Ko: 2000, 2300, 25A, E1200, E125, E1400, E1500, KE3500, VARIO, KE4000, KS, KSB; Alpina: 352, 382, A10E, A14E, E120, E130, E150, ELECTRIC, ES182, ES202, KS1400B, KS1500B; Bosch: 1586, 40-19PRO, AKE30B, AKE30LI, AKE35-19PRO, AKE35B, AKE40B, BULLCRAFT, GKE35BC, GKE40BC, PKE25, PKE30B, PKE35B, PKE40; Dolmar: 100, 101, 102, 103, 104, 105, 106, 108, 275, 285, ES140, ES151, ES152, ES152A, ES153, ES160, ES161, ES162, ES162A, ES163, ES172, ES172A, ES173, ES183, ES2035, ES2040, ES3, ES30, ES37, ES40, ES41, ES6, PS33, PS330, PS3300TH, PS34, PS340, PS341, PS3410, PS344, PS350, PS390, PS400, PS401, PS41, PS45; Echo: CS2600ES, CS260TES, CS2700ES, CS310WES, CS3500ES, CS350WES, CS351WES; Einhell: BG-EC-1840TC, BG-PC-4040, EKS1650, KSE, KSE1435, KSE1635, KSE1640, KSE2000, PES1540, PES1640, PES30, PES34, PES35, PES40, PKS1635, PKS1840, PROFi; Hitachi: CS280A, CS280B, CS30EH, CS350A, CS350B, CS35B; Homelite: 20AV, 23AV, 27, 3300, 3335, 350, 3550, 3800, 3850, 4500, 4550, S40, HCS3335, HCS4041CA, PS33, RANGER, TIMBERMAN, UT10901, UT10926, UT10974; Husqvarna: 23, E16, E316, E317, E321, T425; Jonsered: 2033TH; Makita: 5012, 5014, 5016, BUC122RFE, BUC250RDE, DCS232T, DCS300, DCS330S, DCS340, DCS341, DCS3410TH, DCS350, DCS3510, DCS380, DCS390, DCS400, DCS401, DCS4610, EA3201, EA3500F35B, EA3500F40B, UC250DWB, UC3000, UC3030A, UC3500, UC3501, UC3520A, UC3530AK, UC4000, UC4020A, UC4030AK, UC4530A; McCulloch: 10-42, 10-49, 335, 435, 440, 441, 442, 4600, 4700, 4900, 5000, 738, TIMBERBEAR-849, TITAN41, TITAN46; Oleo-Mac: 931, 932, GS35, GS350, GS370, GS410C; Partner: 330, 335, 340, 345, 350, 351, 352, 360, 370, 385, 391, 395, P390, P420, P842; Ryobi: APR02, PCN3335; Skil: 1620U, 1634U, 1636U

14" 36 cm	± 2 3/8" 9.32 mm	$\pm 0.322"$ 8.2 mm
52	0.05" 1.3 mm	4 RIVETS 4 NITY
ROLLER BEARING ŁOŻYSKO WALECZKOWE		
YATO size / rozmiar YT-84931 14" (36 cm) 20		



for / dla: YT-84961

competitors / odpowiedniki: Oregon: 158SLHD009; Husqvarna: 508914356; Windsor: 15HS58SPNA for / dla: Alpina: P660, P680, P700, P750, P800, PROF700, PROF800; Dolmar: PS6400, PS6400H, PS7300, PS7300H, PS7900, PS7900H, PS9000, PS9010; Dolpima: PS190, PS290, PS390, PS490; Echo: CS3500, CS350WES, CS351WE; Husqvarna: 1100, 160, 162, 181, 2100XP, 2101, 2101XP, 260, 266, 268, 272, 281XP, 285, 288XP, 298, 298X, 298XG, 3120, 3120XP, 365, 371, 371XP, 371XP, 372, 372XP, 372XP, 380, 385, 385XP, 394, 394XP, 394XP, 395, 395XP, 395XP, 480, 562XP, 570, 575, 575XP, 576XP, 61, 64, 65, 66, 70, 77; Jonsered: 1020, 2065, 2071, 2077, 2083, 2094, 2095, 2165, 2171, 2186, 625, 630, 630 SUPER, 670, 670 CHAMP, 820; Makita: DCS6400, DCS6401, DCS7300, DCS7301, DCS7900, DCS79001, DCS9000, DCS9010; Partner: 660, 710, P7700; Solo: 603, 662, 665, 667, 670, 675, 680, 681, 690, 694

15" 38 cm	± 2 3/8" 9.32 mm	$\pm 0.355"$ 9.0 mm
56	0.058" 1.5 mm	4 RIVETS 4 NITY
ROLLER BEARING ŁOŻYSKO WALECZKOWE		
YATO size / rozmiar YT-84932 15" (38 cm) 20		



for / dla: YT-84905, YT-84945, YT-84962

competitors / odpowiedniki: Oregon: 50MLBK095; Dolmar: 415038141; Husqvarna: 508926164, 508926364; Makita: 445038141; Windsor: 15CJL50SPYJ for / dla: Dolmar: 109, 110, 111, 112, 113, 114, 115, 116, PS460, PS4600, PS4600S, PS5100, PS5100S, PS540; Husqvarna: 133, 136, 137, 141, 142, 154, 234, 238, 240, 242, 242XP, 246, 254, 257, 261, 262, 339XP, 340, 345, 346, 346XP, 350, 351, 353, 357, 357XP, 359, 36, 40, 41, 42, 435, 435E, 44, 440E, 444, 445, 445E, 45, 450E, 455 RANCHER, 455E RANCHER, 460, 460 RANCHER, 50, 51, 550, 560XP, T435; Jonsered: 2012, 2014, 2015, 2016, 2036, 2040, 2041, 2045, 2050, 2051, 2054, 2055, 2063, 2141, 2145, 2147, 2149, 2150, 2152, 2153, 2155, 2156, 2159, 2163, 370, 380, 410, 420, 425, 435, 45, 450, 451, 451EVS, 452, 455, 490, 49SP, 50, 51, 510, 52, 520, 521, 525, 535, 590, CS2149W, CS2152W; Makita: 45, DCS430, DCS43001, DCS43001, DCS43001, DCS431, DCS4600S, DCS500, DCS5030, GS44; Partner: 1200EL, 1400EL, 1450EL, 1500EL, 1650EL, 365, 400, 405, 410, 450, 460, 465, 470, 495, 500, 510, 540, 545, P500, P5000, P5500; Solo: 639, 641, 644, 645, 647, 650, 651, 652, 656, 665

15" 38 cm	± 2 0.325" 8.25 mm	$\pm 0.322"$ 8.2 mm
64	0.05" 1.3 mm	4 RIVETS 4 NITY
ROLLER BEARING ŁOŻYSKO WALECZKOWE		
YATO size / rozmiar YT-84933 15" (38 cm) 20		



for / dla: YT-84900, YT-84941, YT-84963

competitors / odpowiedniki: Oregon: 158PXBK095; Dolmar: 415038631; Husqvarna: 508912164, 508912364; Makita: 445038631; Solo: 6900343, 6900343K, 6900343N for / dla: Dolmar: 109, 110, 111, 112, 113, 114, 115, 116, ES1800, PS460, PS4600, PS4600S, PS5000, PS5100, PS5100S, PS540; Homelite: 250, 252, 290, 290C, 300, 340, 340C, 3850B, 3850C, 4045, 415B, 444, 4550B, HCS4040, HCS4446CA; Husqvarna: 133, 136, 137, 141, 142, 154, 234, 235, 238, 240, 242, 242XP, 246, 254, 257, 261, 262, 339XP, 340, 345, 346, 346XP, 350, 351, 353, 357, 357XP, 359, 36, 40, 41, 42, 435, 435E, 44, 440, 440E, 444, 445, 445E, 45, 450E, 455 RANCHER, 455E RANCHER, 460, 460 RANCHER, 50, 51, 550, 560XP, T435; Jonsered: 2012, 2014, 2015, 2016, 2036, 2040, 2041, 2045, 2050, 2051, 2054, 2055, 2063, 2141, 2145, 2147, 2149, 2150, 2152, 2153, 2155, 2156, 2159, 2163, 370, 380, 410, 420, 425, 435, 45, 450, 451, 451EVS, 452, 455, 490, 49SP, 50, 51, 510, 52, 520, 521, 525, 535, 590, CS2149W, CS2152W; Makita: 45, DCS430, DCS43001, DCS43001, DCS431, DCS460, DCS4600S, DCS500, DCS5000, DCS5030, DCS520, DCS5200; NAC: NO-CS38, SPS01-45, SPS01-52, SPS02-45, YD 40/45, YD40, YD52; Oleo-Mac: 850, 938, 940, 941, 942, 942C, 945, 946, 947, 950, 950 Super, 950A, 951, 952, 956, 962 E300F, GS410CX, GS44; Partner: 365, 400, 405, 410, 450, 460, 465, 470, 495, 500, 510, 540, 545, P500, P5000, P5500

15" 38 cm	± 2 0.325" 8.25 mm	$\pm 0.322"$ 8.2 mm
64	0.058" 1.5 mm	4 RIVETS 4 NITY
ROLLER BEARING ŁOŻYSKO WALECZKOWE		
YATO size / rozmiar YT-84934 15" (38 cm) 20		

GB Chainsaw guide bar
D Kettensägeföhrung
PL Prowadnica do pił łańcuchowych
RUS Шина для бензопил

CZ Vodicí lišta k řetězové pile
H Láncezvető
RO Lama de ghidai pt. ferastrau
F Guide de tronçonneuse

I Barra per motosega
E Barra guía motosierra
CN 导板

COLOR
PAPER
POUCH

Mn
65



for / dla: YT-84953, YT-84960

competitors / odpowiedniki: Oregon: 160SDEA041; Oleo-Mac: 50050092; Husqvarna: 530044508; Windsor: 16PKU50SSR; Makita: 442040661, 442040061; Alpina: 4112500; Partner: 530044329

for / dla: Al-Ko: 2000, 2300, 25A, E1200, E125, E1400, E1500, KE3500 VARIO, KE4000, KS, KSB; Alpina: 352, 382, A10E, A14E, E120, E130, E150, ELECTRIC ES182, ES202, KS1400B, KS1500B; Dolmar: 100, 101, 102, 103, 104, 105, 106, 108, 275, 285, ES140, ES151, ES152, ES152A, ES153, ES160, ES161, ES162, ES162A, ES163, ES172, ES172A, ES173, ES183, ES2035, ES2040, ES3, ES30, ES37, ES40, ES41, ES6, PS33, PS330, PS3300TH, PS34, PS340, PS341, PS3410, PS344, PS350, PS390, PS400, PS401, PS41, PS45; Echo: CS2600ES, CS260TES, CS2700ES, CS310WES, CS3500ES, CS350WES, CS351WES, CS360WES; Hitachi: CS280A, CS280B, CS350A, CS350B, CS35B; Homelite: 20AV, 23AV, 27, 3300, 3335, 3350, 3550, 3800, 3850, 4500, 4550, CS40, HCS3335, HCS4041CA, PS33, RANGER, TIMBERMAN, UT10901, UT10926, UT10974; Husqvarna: 23, E16, E316, E317, E321, T425; Jonsered: 2033TH; Makita: 5012, 5014, 5016, BUC122RFE, BUC250RDE, DCS230T, DCS232T, DCS300, DCS300S, DCS330, DCS330S, DCS340, DCS340A, DCS341, DCS3410TH, DCS350, DCS3500, DCS3501, DCS3520A, DCS380, DCS390, DCS400, DCS401, DCS4610, UC3000, UC3030A, UC3500, UC3501, UC3520A, UC3530AK, UC4000, UC4030AK; McCulloch: 338, 442; Oleo-Mac: 931, 932, GS35, GS350, GS370, GS410C; Partner: 330, 335, 340, 345, 350, 351, 352, 360, 370, 385, 391, 395, P390, P420, P842; Ryobi: APR02, PCN3335

16" 40 cm		3/8" 9.32 mm	
	56	0.05" 1.3 mm	0.322" 8.2 mm
	ROLLER BEARING ŁOŻYSKO WALECZKOWE		4 RIVETS 4 NITY
YATO size / rozmiar		YT-84953 16" (40 cm) 20	



for / dla: YT-84900, YT-84943, YT-84963

competitors / odpowiedniki: Oregon: 188SLGK095; Dolmar: 415045631; Makita: 415045631; Windsor: 18CJL58SPYJ9

for / dla: Dolmar: 109, 110, 111, 112, 113, 114, 115, 116, ES1800, PS460, PS4600, PS4605, PS500, PS5000, PS510, PS5100S, PS540; Homelite: 250, 252, 290, 290C, 300, 340, 340C, 3850B, 3850C, 4045, 415B, 444, 4550B, HCS4040, HCS4446CA; Husqvarna: 133, 136, 137, 141, 142, 154, 234, 238, 240, 242, 242XP, 246, 254, 257, 261, 262, 339XP, 340, 345, 346, 346XP, 350, 351, 353, 357, 357XP, 359, 36, 40, 41, 42, 435, 435E, 44, 440, 440E, 444, 445, 445E, 45, 450E, 455 RANCHER, 455E, RANCHER, 460, 460 RANCHER, 50, 51, 550, 560XP, T435; Jonsered: 2012, 2014, 2015, 2016, 2036, 2040, 2041, 2045, 2050, 2051, 2054, 2055, 2063, 2141, 2145, 2147, 2149, 2150, 2152, 2153, 2155, 2156, 2159, 2163, 370, 380, 410, 420, 425, 435, 45, 450, 451, 451EVS, 452, 455, 490, 49S, P50, 51, 510, 52, 520, 521, 525, 535, 590, CS2149W, CS2152W; Makita: 45, DCS430, DCS43001, DCS4300I, DCS431, DCS460, DCS4600S, DCS500, DCS5000, DCS5030, DCS520, DCS520I; NAC: NO-CS38, SPS01-45, SPS01-52, SPS02-45, YD 40/45, YD40, YD52; Oleo-Mac: 850, 938, 940, 941, 942, 942C, 945, 946, 947, 950, 950 Super, 950A, 951, 952, 956, 962, E300F; Partner: 365, 400, 405, 410, 450, 460, 465, 470, 495, 500, 510, 540, 545, P500, P5000, P5500; Solo: 639, 641, 644, 645, 647, 650, 651, 652, 656, 665

18" 45 cm		0.325" 8.25 mm	
	72	0.058" 1.5 mm	0.322" 8.2 mm
	ROLLER BEARING ŁOŻYSKO WALECZKOWE		4 RIVETS 4 NITY
YATO size / rozmiar		YT-84936 18" (45 cm) 20	

GB Chain for chainsaw
D Kette für Kettensägen
PL Łańcuch łańcuch do pił
RUS Цепь для бензопилы

CZ Řetěz pro řetězové pily
H Lānc lāncfűrész
RO Lant pt. drujba
F Chaîne de tronçonneuse

I Taglio per motoseghea
E Cadena de motosierra
CN 蠟沫

COLOR BOX
WITH EURO HOLE



for / dla: YT-84900

for / dla: Alpina: A40, A40E, P400, P450, P460, P500, P510, P522, PRO540, PRO600, PROF-41, PROF-45; Dolmar: 109, 110, 111, 112, 113, 114, 115i, 116, ES1800, PS460, PS4600, PS4605, PS500, PS5000, PS510, PS5100S, PS540; Echo: CS4200ES, CS4400; Homelite: 250, 252, 290, 290C, 300, 340, 340C, 3850B, 3850C, 415B, 444, 4550B, HCS4040, HCS4045, HCS4446CA; Husqvarna: 133, 136, 137, 140, 141, 142, 154, 234, 235, 238, 240, 240e, 242, 242XP, 246, 254, 254XP, 257, 261, 262, 338XP, 339XP, 340, 345, 346, 346XP, 350, 351, 353, 357, 357XP, 359, 36, 365, 40, 41, 42, 435, 435E, 44, 440E, 444, 445, 445E, 45, 450E, 455 RANCHER, 455E ANCHER, 460, 460 RANCHER, 50, 51, 55; Jonsered: 2012, 2014, 2015, 2016, 2036, 2040, 2041, 2045, 2050, 2051, 2054, 2055, 2063, 2141, 2145, 2147, 2149, 2150, 2152, 2153, 2155, 2156, 2159, 2163, 370, 380, 410, 420, 425, 435, 45, 450, 451, 451EVS, 452, 455, 490, 49SP, 50, 51, 510, 52, 521, 525, 535, 590, CS2149W, CS2152W; Makita: 45, DCS430, DCS43001, DCS4300I, DCS431, DCS460, DCS4600S, DCS500, DCS5000, DCS5030, DCS520, DCS520I; NAC: NO-CS38, SPS01-45, SPS01-52, SPS02-45, YD 40/45, YD40, YD52; Oleo-Mac: 850, 938, 940, 941, 942, 945, 946, 947, 950, 950 Super, 950A, 951, 952, 956, 962, E300F; Partner: 1650, 365, 400, 405, 410, 450, 460, 465, 470, 495, 500, 510, 540, 545, P500, P5000, P5500

14" 36 cm		0.325" 8.25 mm	
	56	0.058" 1.5 mm	SEMI-CHISEL POL-OLITO
	LUBRICATION SYSTEM SYSTEM SMAROWANIA		
YATO size / rozmiar		YT-84940 14" (36 cm) 50	



for / dla: YT-84900, YT-84934

for / dla: Dolmar: 109, 110, 111, 112, 113, 114, 115i, 116, ES1800, PS460, PS4600, PS4605, PS500, PS5000, PS5510, PS5100S, PS540; Husqvarna: 154, 257, 440e, 133, 136, 137, 140, 141, 142, 234, 235, 238, 240, 240e, 242, 242XP, 246, 254, 254XP, 261, 262, 338XP, 339XP, 340, 345, 346, 346XP, 350, 351, 353, 357, 357XP, 359, 36, 365, 372XP, 40, 41, 42, 435, 435E, 44, 444, 445, 445E, 45, 450E, 455 RANCHER, 455E RANCHER, 460 RANCHER, 50, 51, 55, T435; Jonsered: 520, 2012, 2014, 2015, 2016, 2036, 2040, 2041, 2045, 2050, 2051, 2054, 2055, 063, 2141, 2145, 2147, 2149, 2150, 2152, 2153, 2155, 2156, 2159, 2163, 370, 380, 410, 420, 425, 435, 45, 450, 451, 451EVS, 452, 455, 490, 49SP, 50, 51, 510, 52, 521, 525, 535, 590, CS2149W, CS2152W; Makita: 45, DCS430, DCS43001, DCS4300I, DCS431, DCS460, DCS4600S, DCS500, DCS5000, DCS5030, DCS520, DCS520I; NAC: NO-CS38, SPS01-45, SPS01-52, SPS02-45, YD 40/45, YD40, YD52; Oleo-Mac: 850, 938, 940, 941, 942, 945, 946, 947, 950, 950 Super, 950A, 951, 952, 956, 962, E300F; Partner: 1650, 365, 400, 405, 410, 450, 460, 465, 470, 495, 500, 510, 540, 545, P500, P5000, P5500

15" 38 cm		0.325" 8.25 mm	
	64	0.058" 1.5 mm	SEMI-CHISEL POL-OLITO
	LUBRICATION SYSTEM SYSTEM SMAROWANIA		
YATO size / rozmiar		YT-84941 15" (38 cm) 50	



for / dla: YT-84900

for / dla: Dolmar: 109, 110, 111, 112, 113, 114, 115i, 116, ES1800, PS460, PS4600, PS4605, PS500, PS5000, PS5510, PS5100S, PS540; Husqvarna: 154, 257, 440e, 133, 136, 137, 140, 141, 142, 234, 235, 238, 240, 240e, 242, 242XP, 246, 254, 254XP, 261, 262, 338XP, 339XP, 340, 345, 346, 346XP, 350, 351, 353, 357, 357XP, 359, 36, 365, 372XP, 40, 41, 42, 435, 435E, 44, 444, 445, 445E, 45, 450E, 455 RANCHER, 455E RANCHER, 460 RANCHER, 50, 51, 55, T435; Jonsered: 520, 2012, 2014, 2015, 2016, 2036, 2040, 2041, 2045, 2050, 2051, 2054, 2055, 063, 2141, 2145, 2147, 2149, 2150, 2152, 2153, 2155, 2156, 2159, 2163, 370, 380, 410, 420, 425, 435, 45, 450, 451, 451EVS, 452, 455, 490, 49SP, 50, 51, 510, 52, 521, 525, 535, 590, CS2149W, CS2152W; Makita: 45, DCS430, DCS43001, DCS4300I, DCS431, DCS460, DCS4600S, DCS500, DCS5000, DCS5030, DCS520, DCS520I; NAC: NO-CS38, SPS01-45, SPS01-52, SPS02-45, YD 40/45, YD40, YD52; Oleo-Mac: 850, 938, 940, 941, 942, 945, 946, 947, 950, 950 Super, 950A, 951, 952, 956, 962, E300F; Partner: 1650, 365, 400, 405, 410, 450, 460, 465, 470, 495, 500, 510, 540, 545, P500, P5000, P5500

16" 40 cm		0.325" 8.25 mm	
	66	0.058" 1.5 mm	SEMI-CHISEL POL-OLITO
	LUBRICATION SYSTEM SYSTEM SMAROWANIA		
YATO size / rozmiar		YT-84942 16" (40 cm) 50	

GB Chain for chainsaw
D Kette für Kettensägen
PL Łańcuch tnący do pił
RUS Цепь для бензопилы

CZ Řetěz pro řetězové pily
H Lānc lāncfūrész
RO Lant pt. drijba
F Chaîne de tronçonneuse

I Taglio per motoseghea
E Cadena de motosierra
CN 蠟沫

COLOR BOX
WITH EURO HOLE



Mn
65



for / dla: YAT-84900, YAT-84936

for / dla: **Dolmar:** 109, 110, 111, 112, 113, 114, 115i, 116, ES1800, PS460, PS4600, PS4605, PS500, PS5000, PS5510, PS5100S, PS540; **Husqvarna:** 154, 257, 440e, 133, 136, 137, 140, 141, 142, 234, 235, 238, 240, 240e, 242, 242XP, 246, 254, 254XP, 261, 262, 338XPT, 339XP, 340, 345, 346, 346XP, 350, 351, 353, 357, 357XP, 359, 36, 365, 372XP, 40, 41, 42, 435, 435E, 44, 444, 445, 445E, 45, 450E, 455 RANCHER, 455E RANCHER, 460 RANCHER, 50, 51, 55, T435; **Jonsered:** 520, 2012, 2014, 2015, 2016, 2036, 2040, 2041, 2045, 2050, 2051, 2054, 2055, 063, 2141, 2145, 2147, 2149, 2150, 2152, 2153, 2155, 2159, 2163, 370, 380, 410, 420, 425, 435, 45, 450, 451, 451EVS, 452, 455, 490, 495P, 50, 51, 510, 52, 521, 525, 535, 590, CS2149W, CS2152W; **Makita:** 45, DCS430, DCS43001, DCS43001, DCS431, DCS460, DCS4600S, DCS4630, DCS500, DCS5000, DCS5030, DCS520, DCS5200; **NAC:** NO-CS38, SPS01-45, SPS01-52, SPS02-45, YD 40/45, YD40, YD52; **Oleo-Mac:** 850, 938, 940, 941, 942, 945, 946, 947, 950, 950 Super, 950A, 951, 952, 956, 962, E300F; **Partner:** 1650, 365, 400, 405, 410, 450, 460, 465, 470, 495, 500, 510, 540, 545, P500, P5000, P5500

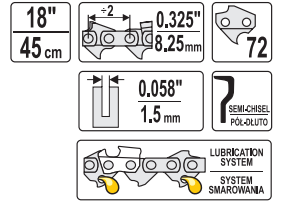

YATO	size / rozmiar	box
YAT-84943	18" (45 cm)	50



for / dla: YAT-84900

for / dla: **Dolmar:** 109, 110, 111, 112, 113, 114, 115i, 116, ES1800, PS460, PS4600, PS4605, PS500, PS5000, PS5510, PS5100S, PS540; **Husqvarna:** 154, 257, 440e, 133, 136, 137, 140, 141, 142, 234, 235, 238, 240, 240e, 242, 242XP, 246, 254, 254XP, 261, 262, 338XPT, 339XP, 340, 345, 346, 346XP, 350, 351, 353, 357, 357XP, 359, 36, 365, 372XP, 40, 41, 42, 435, 435E, 44, 444, 445, 445E, 45, 450E, 455 RANCHER, 455E RANCHER, 460 RANCHER, 50, 51, 55, T435; **Jonsered:** 520, 2012, 2014, 2015, 2016, 2036, 2040, 2041, 2045, 2050, 2051, 2054, 2055, 063, 2141, 2145, 2147, 2149, 2150, 2152, 2153, 2155, 2159, 2163, 370, 380, 410, 420, 425, 435, 45, 450, 451, 451EVS, 452, 455, 490, 495P, 50, 51, 510, 52, 521, 525, 535, 590, CS2149W, CS2152W; **Makita:** 45, DCS430, DCS43001, DCS43001, DCS431, DCS460, DCS4600S, DCS4630, DCS500, DCS5000, DCS5030, DCS520, DCS5200; **NAC:** NO-CS38, SPS01-45, SPS01-52, SPS02-45, YD 40/45, YD40, YD52; **Oleo-Mac:** 850, 938, 940, 941, 942, 945, 946, 947, 950, 950 Super, 950A, 951, 952, 956, 962, E300F; **Partner:** 1650, 365, 400, 405, 410, 450, 460, 465, 470, 495, 500, 510, 540, 545, P500, P5000, P5500

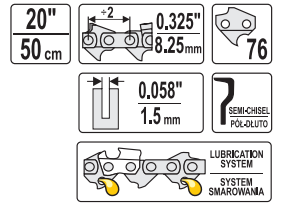

YATO	size / rozmiar	box
YAT-84944	20" (50 cm)	50



for / dla: YAT-84905, YAT-84933

for / dla: **Dolmar:** 109, 110, 111, 112, 113, 114, 115i, 116, PS460, PS4600, S4605, PS500, PS5000, PS510, PS5100S, PS540; **Husqvarna:** 133, 136, 137, 141, 142, 154, 234, 238, 240, 242, 42XP, 246, 254, 254XP, 257, 261, 262, 338XPT, 339XP, 340, 345, 346, 346XP, 350, 351, 353, 357, 357XP, 359, 36, 65, 40, 41, 42, 435, 435E, 44, 440E, 444, 445, 445E, 45, 450E, 455 RANCHER, 455E RANCHER, 460, 460 RANCHER, 50, 51, 55, T435; **Jonsered:** 2012, 2014, 2015, 2016, 2036, 2040, 2041, 2045, 2050, 051, 2054, 2055, 2063, 2141, 2145, 2147, 2149, 2150, 2152, 2153, 2155, 2156, 2159, 2163, 370, 380, 410, 420, 425, 435, 45, 450, 451, 451EVS, 452, 455, 490, 495P, 50, 51, 510, 52, 520, 521, 525, 535, 590, CS2149W, CS2152W; **Makita:** 45, DCS430, DCS43001, DCS43001, DCS431, DCS460, DCS4600S, DCS4630, DCS500, DCS5000, DCS5030, DCS520, DCS5200; **Oleo-Mac:** 850, 938, 940, 941, 941C, 942, 945, 946, 947, 950, 950 Super, 950A, 951, 952, 956, 962, E300F, GS350, GS370, GS410CX; **Partner:** 1200EL, 1400EL, 1450EL, 1500EL, 1650EL, 365, 400, 405, 410, 450, 460, 465, 470, 495, 500, 510, 540, 545, P500, P5000, P5500

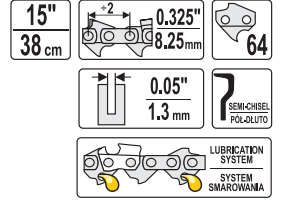

YATO	size / rozmiar	box
YAT-84945	15" (38 cm)	50



for / dla: **Alpina:** 270, 280, 330, 380, 432, 438, EURO-40, EURO-45, Elletra 160, Elletra 170, Energy 1.6, Energy 1.8, P360, P370, P390, PR350, Sinergy 35, Sinergy 40; **Dolmar:** CS2040, PS3300TH; **Husqvarna:** T425; **McCulloch:** 3500, 370, 374, 375, 384, 400, 400P, 430, 442, 445, 470, 474, 484, 838, 839, ELECTRAMAC 16E, MAC110, MAC120, MAC130, MAC140, MAC4, MAC6, MAC90, MAC935, MC115, MM30, MM36, PM310, PM320, PM330, PM340, PM36, PM360, PM364, PM370, PM380, PM394, PM400, M470, PM480, PM484, PM510, PM730; **Oleo-Mac:** 240, OEM200; **Partner:** 1535EL, 1540, 1540EL, 1640, 1835, 1840, 352, 371, 391, 538E, 542E, P1535, P351; **Stihl:** 009, 010, 011, 012, 017, 018, 019, 019T, 020, 020T, 021, 021C, 023, 025, 25, MS160, MS170, MS180, MS181, MS191, MS192, MS200, MS200T, MS210, MS211, MS230, MS231, MS241, MS250, MS251, MSE140, MSE200

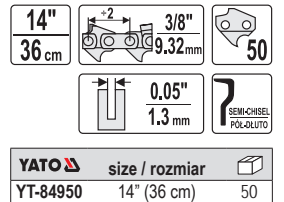

YATO	size / rozmiar	box
YAT-84950	14" (36 cm)	50



for / dla: YAT-84931

for / dla: **Al-Ko:** 2000, 2300, 25A, E1200, E125, E1400, E1500, KE3500 VARIO, KE4000, KS, KSB; **Alpina:** 352, 382, A10E, A14E, E120, E130, E150, ELECTRIC, ES182, ES202, KS1400B, KS1500B; **Dolmar:** 100, 101, 102, 103, 104, 105, 106, 108, 275, 285, CS2040E, S140, ES151, ES152, ES152A, ES153, ES160, ES161, ES162, ES162A, ES163, ES172, ES172A, ES173, ES183, ES2035, ES2040, ES3, ES30, ES37, ES40, ES41, ES6, PS33, PS330, PS3300TH, PS3300TH, PS34, PS340, PS341, PS3410, PS344, PS350, PS390, PS400, PS401, PS41, PS45; **Echo:** CS2600ES, CS2607ES, CS2700ES, CS3500ES, CS3500WES, CS351WES; **Hitachi:** CS280A, CS280B, CS350A, CS350B, CS35B; **Homelite:** 20AV, 23AV, 27, 3300, 3335, 3350, 3550, 3800, 4500, 4550, CS40, HCS3335, HCS4041CA, PS33, RANGER, TIMBERMAN, UT10901, UT10926, UT10974; **Husqvarna:** 136, 137, 1400, 141, 142, 16, 1600, 23, 243, 315, 316, 318, 320, 321, 33, 333, 334, 335XP, 338, 338XPT, 36, 41, E16, E316, E317, E321, T425; **Jonsered:** 2033TH, 2035, 2115, 2115EL, 2116, 2117, 2118EL, 2121, 2135, 2137, 2138, 2139; **Makita:** 5012, 5016, BUC122RFE, BUC250RDE, DCS230T, DCS232T, DCS300, DCS300S, CS330, DCS330S, DCS34, DCS340, DCS341, DCS3410TH, DCS350, DCS3500, DCS3501, DCS3520A, DCS380, DCS390, DCS400, DCS401, DCS4610, UC3000, UC3030A, UC3500, UC3501, UC3520A, UC3530AK, UC4000, UC4030AK; **McCulloch:** MS1215, MS1415, MS1425, MS1435, MS1630, MS1635AV, MS1640, MS1645, MS1834N, MS1845J; **Oleo-Mac:** 931, 932, GS35, GS350, GS370; **Partner:** 330, 335, 340, 345, 350, 351, 360, 370, 385, 391, 395, P390, P420, P842; **Ryobi:** APR02, PCN33351

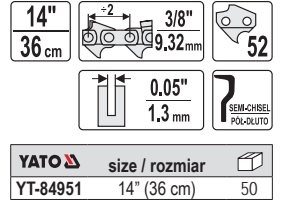

YATO	size / rozmiar	box
YAT-84951	14" (36 cm)	50



for / dla: YAT-84935

for / dla: **Al-Ko:** 2000, 2300, 25A, E1200, E125, E1400, E1500, KE3500 VARIO, KE4000, KS, KSB; **Alpina:** 352, 382, A10E, A14E, E120, E130, E150, ELECTRIC, ES182, ES202, KS1400B, KS1500B; **Dolmar:** 100, 101, 102, 103, 104, 105, 106, 108, 275, 285, CS2040E, S140, ES151, ES152, ES152A, ES153, ES160, ES161, ES162, ES162A, ES163, ES172, ES172A, ES173, ES183, ES2035, ES2040, ES3, ES30, ES37, ES40, ES41, ES6, PS33, PS330, PS3300TH, PS3300TH, PS34, PS340, PS341, PS3410, PS344, PS350, PS390, PS400, PS401, PS41, PS45; **Echo:** CS2600ES, CS2607ES, CS2700ES, CS3500ES, CS3500WES, CS351WES; **Hitachi:** CS280A, CS280B, CS350A, CS350B, CS35B; **Homelite:** 20AV, 23AV, 27, 3300, 3335, 3350, 3550, 3800, 4500, 4550, CS40, HCS3335, HCS4041CA, PS33, RANGER, TIMBERMAN, UT10901, UT10926, UT10974; **Husqvarna:** 136, 137, 1400, 141, 142, 16, 1600, 23, 243, 315, 316, 318, 320, 321, 33, 333, 334, 335XP, 338, 338XPT, 36, 41, E16, E316, E317, E321, T425; **Jonsered:** 2033TH, 2035, 2115, 2115EL, 2116, 2117, 2118EL, 2121, 2135, 2137, 2138, 2139; **Makita:** 5012, 5016, BUC122RFE, BUC250RDE, DCS230T, DCS232T, DCS300, DCS300S, CS330, DCS330S, DCS34, DCS340, DCS341, DCS3410TH, DCS350, DCS3500, DCS3501, DCS3520A, DCS380, DCS390, DCS400, DCS401, DCS4610, UC3000, UC3030A, UC3500, UC3501, UC3520A, UC3530AK, UC4000, UC4030AK; **McCulloch:** MS1215, MS1415, MS1425, MS1435, MS1630, MS1635AV, MS1640, MS1645, MS1834N, MS1845J; **Oleo-Mac:** 931, 932, GS35, GS350, GS370; **Partner:** 330, 335, 340, 345, 350, 351, 360, 370, 385, 391, 395, P390, P420, P842; **Ryobi:** APR02, PCN3335

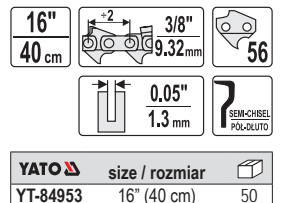

YATO	size / rozmiar	box
YAT-84953	16" (40 cm)	50

GB Chain for chainsaw
D Kette für Kettensägen
PL Łańcuch tnący do pił
RUS Цепь для бензопилы

CZ Řetěz pro řetězové pily
H Lánċ lánċfürész
RO Lant pt. drijba
F Chaîne de tronçonneuse

I Taglio per motoseghea
E Cadena de motosierra
CN 蠟沫

COLOR BOX
WITH EURO HOLE



for / dla: YT-84935

for / dla: **Al-Ko:** 2000, 2300, 25A, E1200, E125, E1400, E1500, KE3500 VARIO, KE4000, KS, KSB; **Alpina:** 352, 382, A10E, A14E, E120, E130, E150, ELECTRIC, ES182, ES202, KS1400B, KS1500B; **Dolmar:** 100, 101, 102, 103, 104, 105, 106, 108, 275, 285, CS2040, ES140, ES151, ES152, ES152A, ES153, ES160, ES161, ES162, ES162A, ES163, ES172, ES172A, ES173, ES183, ES2035, ES2040, ES3, ES30, ES37, ES40, ES41, ES6, PS33, PS330, PS3300TH, PS330TH, PS34, PS340, PS341, PS3410, PS344, PS350, PS390, PS400, PS401, PS41, PS45; **Echo:** CS2600ES, CS260TES, CS2700ES, CS3500ES, CS3500WES, CS351WES; **Hitachi:** CS280A, CS280B, CS350A, CS350B, CS35B; **Homelite:** 20AV, 23AV, 27, 3300, 3335, 3350, 3500, 3800, 4500, 4550, CS40, HCS3335, HCS4041CA, PS33, RANGER, TIMBERMAN, UT10901, UT10926, UT10974; **Husqvarna:** 23, E16, E316, E317, E321, T425; **Jonsered:** 2033TH; **Makita:** 5012, 5016, BUC122RFE, BUC250RDE, DCS230T, DCS230T, DCS300, DCS300S, DCS330, DCS330S, DCS340, DCS340, DCS341, DCS3410TH, DCS350, DCS3500, DCS3501, DCS3520A, DCS380, DCS390, DCS400, DCS401, DCS4610, UC3000, UC3030A, UC3500, UC3501, UC3520A, UC3530AK, UC4000, UC4030AK; **Oleo-Mac:** 931, 932, GS35, GS350, GS370; **Partner:** 330, 335, 340, 345, 350, 351, 370, 385, 395, P390, P420; **Ryobi:** APR02, PCN3335

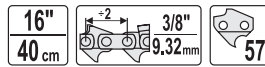

YATO 	size / rozmiar	
YT-84954	16" (40 cm)	50

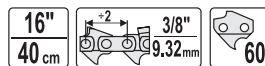

YATO 	size / rozmiar	
YT-84955	16" (40 cm)	50

GB Chain for chainsaw
D Kette für Kettensägen
PL Łańcuch tnący do pił
RUS Цепь для бензопилы

CZ Řetěz pro řetězové pily
H Lánċ lánċfürész
RO Lant pt. drijba
F Chaîne de tronçonneuse

I Taglio per motoseghea
E Cadena de motosierra
CN 蠟沫

PAPER SPOOL & COLOR LABEL
PLUS 30 PCS OF ADDITIONAL
COLOR BOXES & POLYBAGS



for / dla: YT-84930, YT-84931, YT-84935

for / dla: **Alpina:** 270, 280, 330, 380, 432, 438, EURO-40, EURO-45, Elletra 160, Elletra 170, Energy 1.6, Energy 1.8, P360, P370, P390, PR350, Sinergy 35, Sinergy 40; **Dolmar:** CS2040, PS3300TH; **Husqvarna:** T425; **McCulloch:** 3500, 370, 374, 375, 384, 400, 400P, 430, 442, 445, 470, 474, 484, 838, 839, ELECTRA MAC 16E, MAC110, MAC120, MAC130, MAC140, MAC4, MAC6, MAC930, MAC935, MC115, MM30, MM36, PM310, PM320, PM330, PM340, PM36, PM360, PM364, PM370, PM380, PM394, PM400, M470, PM480, PM484, PM510, PM730; **Oleo-Mac:** 240, OEM200; **Partner:** 1535EL, 1540, 1540EL, 1640, 1835, 1840, 352, 371, 391, 538E, 542E, P1535, P351; **Stihl:** 009, 010, 011, 012, 017, 018, 019, 019T, 020, 020T, 021, 021C, 023, 025, 25, MS160, MS170, MS180, MS181, MS191, MS192, MS200, MS200T, MS210, MS211, MS230, MS231, MS241, MS250, MS251, MSE140, MSE200

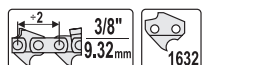



YATO 	size / rozmiar	
YT-84960		1

for / dla: YT-84932

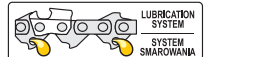
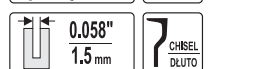
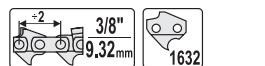
for / dla: **Alpina:** P700, P750, P800, PROF700, PROF800; **Dolmar:** 115, 117, 119, 120, 120SI, 122, 123, 1231, 133, 143, 152, 153, 186, 219, CA, KMS4, PS43, PS6000I, PS6000IH, PS6400, PS6400H, PS6800I, PS6800IH, PS7300H, PS7900, PS7900H, PS9000, PS9010; **Echo:** CS3500, CS3500WES, CS351WE; **Husqvarna:** 1100, 154, 160, 162, 181, 2100XP, 2101, 2101XP, 254, 257, 260, 261, 262, 266, 268, 272, 281XP, 285, 288XP, 298, 298X, 298XG, 3120, 3120XP, 357, 357XP, 359, 362, K34365, 371, 371XP, 371XPG, 372, 372XP, 372XPG, 380, 385, 385XP, 394, 394XP, 394XPG, 395, 395XP, 395XPG, 455, 480, 55, 560XP, 562XP, 570, 575, 575XP, 576XP, 61, 64, 65, 66, 70, 77; **Jonsered:** 1020, 2063, 2065, 2071, 2077, 2083, 2094, 2095, 2159, 2163, 2165, 2171, 2186, 625, 630, 630 SUPER, 670, 670 CHAMP, 820; **Makita:** DCS460, DCS4600, DCS500, DCS5030, DCS6400, DCS6401, DCS7301, DCS7901, DCS9000, DCS9010; **Oleo-Mac:** 250A, 251, 252, 254, 261, 264, 271, 272, 284, 350, 355, 460, 480, 481, 482, 484, 970, 971, 980, 981, E300; **Partner:** 550, 660, 710, P770



YATO 	size / rozmiar	
YT-84961		1

for / dla: YT-84905, YT-84933

for / dla: **Dolmar:** 109, 110, 111, 112, 113, 114, 115, 116, PS460, PS4600, S4605, PS500, PS5000, PS510, PS5100S, PS540; **Husqvarna:** 133, 136, 137, 141, 142, 154, 234, 238, 240, 242, 42XP, 246, 254, 254XP, 257, 261, 262, 338XPT, 339XP, 340, 345, 346, 346XP, 350, 351, 353, 357, 357XP, 359, 36, 65, 40, 41, 42, 435, 435E, 44, 440E, 444, 445, 445E, 45, 450E, 455 RANCHER, 455E RANCHER, 460, 460 RANCHER, 50, 51, 55, T435; **Jonsered:** 2012, 2014, 2015, 2016, 2036, 2040, 2041, 2045, 2050, 051, 2054, 2055, 2063, 2141, 2145, 2147, 2149, 2150, 2152, 2153, 2155, 2156, 2159, 2163, 370, 380, 410, 420, 425, 435, 45, 450, 451, 451EVS, 452, 455, 490, 495P, 50, 51, 510, 52, 520, 521, 525, 535, 590, CS2149W, CS2152W; **Makita:** 45, DCS430, DCS43001, DCS4300I, DCS431, DCS460, DCS4600S, DCS4630, DCS500, DCS5000, DCS5030, DCS520, DCS5200I; **Oleo-Mac:** 850, 938, 940, 941, 941C, 942, 945, 946, 947, 950, 950 Super, 950A, 951, 952, 956, 962, E300F, GS350, GS370, GS410CX; **Partner:** 1200EL, 1400EL, 1450EL, 1500EL, 1650EL, 365, 400, 405, 410, 450, 460, 465, 470, 495, 500, 510, 540, 545, P500, P5000, P5500

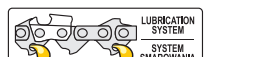

YATO 	size / rozmiar	
YT-84962		1

for / dla: YT-84900, YT-84934, YT-84936

for / dla: **Dolmar:** 109, 110, 111, 112, 113, 114, 115, 116, ES1800, PS460, PS4600, PS4605, PS500, PS5000, PS5510, PS5100S, PS540; **Husqvarna:** 154, 257, 440e, 133, 136, 137, 140, 141, 142, 234, 235, 238, 240, 240e, 242, 242XP, 246, 254, 254XP, 261, 262, 338XPT, 339XP, 340, 345, 346, 346XP, 350, 351, 353, 357, 357XP, 359, 36, 365, 372XP, 40, 41, 42, 435, 435E, 44, 444, 445, 445E, 45, 450E, 455 RANCHER, 455E RANCHER, 460 RANCHER, 50, 51, 55, T435; **Jonsered:** 520, 2012, 2014, 2015, 2016, 2036, 2040, 2041, 2045, 2050, 2051, 2054, 2055, 063, 2141, 2145, 2147, 2149, 2150, 2152, 2153, 2155, 2156, 2159, 2163, 370, 380, 410, 420, 425, 435, 45, 450, 451, 451EVS, 452, 455, 490, 495P, 50, 51, 510, 52, 521, 525, 535, 590, CS2149W, CS2152W; **Makita:** 45, DCS430, DCS43001, DCS4300I, DCS431, DCS460, DCS4600S, DCS4630, DCS500, DCS5000, DCS5030, DCS520, DCS5200I; **NAC:** NO-CS38, SPS01-45, SPS01-52, SPS02-45, YD 40/45, YD40, YD52; **Oleo-Mac:** 850, 938, 940, 941, 942, 945, 946, 947, 950, 950 Super, 950A, 951, 952, 956, 962, E300F; **Partner:** 1650, 365, 400, 405, 410, 450, 460, 465, 470, 495, 500, 510, 540, 545, P500, P5000, P5500

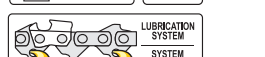

YATO 	size / rozmiar	
YT-84963		1

- GB** Chainsaw chain spinner
- D** Sägekette nietgerät
- PL** Nitownica do łańcuchów do pilarek
- RUS** Станок для клепания цепей
- CZ** Nitovačka pilových řetězů
- H** Szegecselő készülék fűrészlánchoz
- RO** Masina de nituit lanturi si de spart lanturi
- F** Riveteuse d'établi pour chaînes de tronçonneuses
- I** Catena spinner
- E** Remachadora banco cadenas de motosierra
- CN** 剿蠟

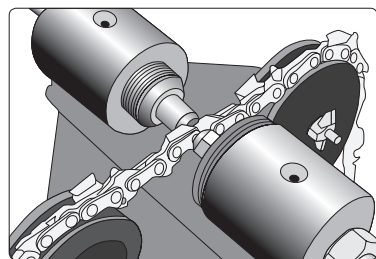
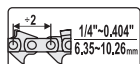

COLOR BOX



YATO	
YT-84970	6

- GB** Chainsaw chain breaker
- D** Sägeketten Entnietgerät
- PL** Rozkuwarka do łańcuchów pilarek
- RUS** Станок для расклепки цепей
- CZ** Roznitovačka pilových řetězů
- H** Szegecskinyomó fűrészlánchoz
- RO** Masina spart lant drujba
- F** Deriveteuse chaîne de tronçonneuse
- I** Catena breaker
- E** Rompe cadenas de motosierra
- CN** 誘蠟

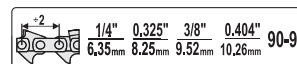

COLOR BOX



YATO	
YT-84971	6

- GB** Electric hoist
- D** Elektro-Seilwinde
- PL** Elektryczny wciągnik linowy
- RUS** Электрическая канатная лебедка
- CZ** Elektrický naviják kladkostroj
- H** Elektromos csőrő
- RO** Troliu electric cu cablu
- F** Treuil électrique à corde
- I** Verricello elettrico
- E** Cabría eléctrica de cuerdas
- CN** 电动葫芦



COLOR BOX

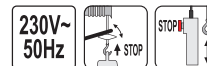

500 W		
	125 kg	250 kg
$L_{PA} \leq 70$ dB; $L_{WA} \leq 85$ dB		
	8 m/min max. 11m 125 kg	4 m/min max. 5.5m 250 kg
YATO	W	
YT-5901	500	2

550 W		
	150 kg	300 kg
$L_{PA} \leq 70$ dB; $L_{WA} \leq 85$ dB		
	8 m/min max. 11m 150 kg	4 m/min max. 5.5m 300 kg
YATO	W	
YT-5902	550	2

900 W		
	250 kg	500 kg
$L_{PA} \leq 70$ dB; $L_{WA} \leq 85$ dB		
	8 m/min max. 11m 250 kg	4 m/min max. 5.5m 500 kg
YATO	W	
YT-5904	900	2

1050 W		
	300 kg	600 kg
$L_{PA} \leq 70$ dB; $L_{WA} \leq 85$ dB		
	8 m/min max. 11m 300 kg	4 m/min max. 5.5m 600 kg
YATO	W	
YT-5905	1050	2

Memo

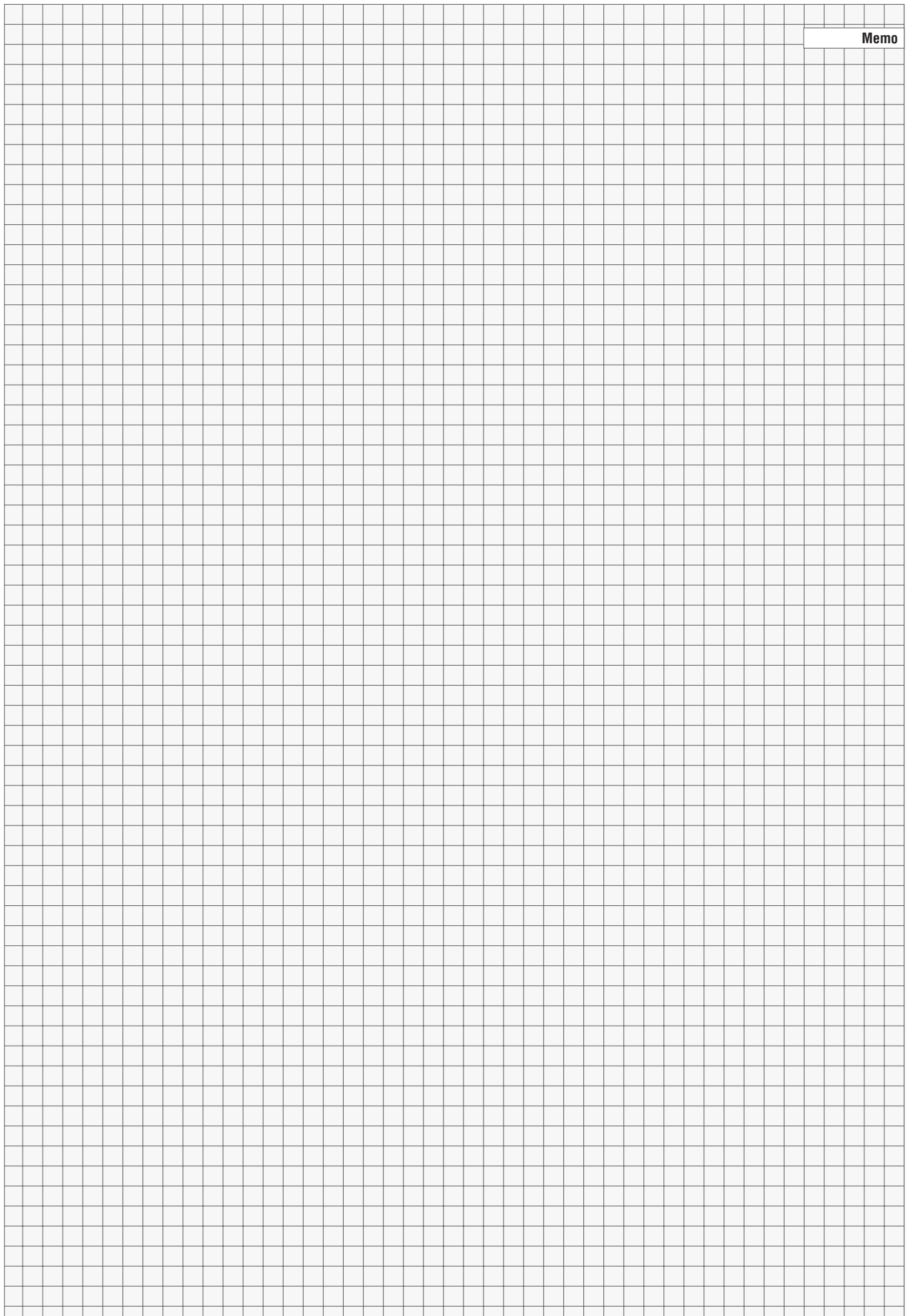

19

Accessories Akcesoria



Tool belts
Pasy na narzędzia

418



Tool bags
Torby narzędziowe

419-420



Tool pockets
Kieszenie na narzędzia

418-419



GB Heavy duty nail & tool pouch
D Werkzeuggürtel mit Nägel- und Schraubentaschen
PL Pas z kieszeniami na gwoździe i narzędzia
RUS Ремень с сумками для гвоздей и инструментов

CZ Pás na nářadí pětikapsový
H Szeg és szerszámartó öv
RO Centura port scule
F Ceinture porte-outils clous
I Cintura con le tasche per chiodi e utensili

E Cinturón porta herramientas y accesorios varios
CN 重型工具袋



21
POCKETS
KIESZENI

130
cm

HEAVY
DUTY
NYLON



YATO	
YT-7400	10

GB Pouch belt
D Gürtel für Werkzeugtaschen
PL Pas na kieszenie na narzędzia
RUS Пояс для карманов для инструмента
CZ Opasek na monterské kapsáře
H Öv erszényhez
RO Cureau cu buzunar
F Ceinture porte-outils
I Cintura con le tasche porta utensili
E Cinturón para bolsas de herramientas
CN 工具腰带



90-120
cm

HEAVY
DUTY
NYLON

YATO	
YT-7409	50/100

GB 8-pocket tool bag
D Gürtelwerkzeugtasche mit 8 Fächern
PL 8. kieszeniowa torba na narzędzia
RUS Сумка - 8 карманов для инструмента
CZ Kapsář na nářadí 8-kapsový
H Szerszámartó erszény, 8 zsebbel
RO Geanta pt. scule 8 buzunare
F Pochette à outils
I Borsa porta attrezzi con 8 tasche
E Bolso para herramientas de 8 bolsillos
CN 工具包

HEADER
CARD



8
POCKETS
KIESZENI

HEAVY
DUTY
NYLON

GB Universal cordless drill holder
D Gürteltasche für Akkuschauber
PL Kieszeń na wiertarkę akumulatorową
RUS Карман для аккумуляторной дрели
CZ Kapsář za opasek na akuvrtčku
H Univerzális tartóerszény akkus csavabehajtóhoz

RO Suport universal pt. bormasina
F Pochette à perceuse sans fil
I Fondina per trapano a batteria
E Bolsa porta taladradora de acumulador
CN 电钻通用挂袋

HEADER
CARD



HEAVY
DUTY
NYLON



YATO	
YT-7410	20/40

YATO	
YT-7413	10/40

YATO	
YT-7414	48/96

GB Nail / tool pouch
D Gürtelwerkzeugtasche
PL Kieszeń na gwoździe i narzędzia
RUS Карман для гвоздей и инструментов
CZ Kapsář na nářadí
H Szeg és szerszámartó erszény
RO Buzunar pt. scule / cuie
F Pochette à outils et clous
I Tasche per chiodi e utensili
E Bolsa porta herramientas y accesorios varios
CN 钉子袋

HEADER
CARD



HEAVY
DUTY
NYLON



YATO	
YT-7416	20/40

YATO	
YT-7417	39/156

- GB** Nail pocket + hammer loop
D Hammer und Nägel-Gürteltasche
PL Kieszon z uchwytem na młotek
RUS Карман-держатель для молотка
CZ Kapsář za opasek na kladivo
H Szeg tartó erszény kalapácartartóval
RO Suport pt. ciocan
F Pochette à outils + porte-marteau
I Tasca porta martello
E Bolsa con el soporte para martillo
CN 锤头钉子袋



HEAVY DUTY NYLON

HEADER CARD



YATO

YT-7419

40/80

- GB** Mobile phone pouch
D Handy-Gürteltasche
PL Kieszon na telefon komórkowy
RUS Карман для мобильного телефона
CZ Pouzdro za opasek na mobilni telefon
H Mobil telefon tartó
RO Suport pt. telefon
F Pochette à téléphone portable
I Tasca porta cellulare
E Bolsa de teléfono móvil
CN 手机袋



HEAVY DUTY NYLON

HEADER CARD



YATO

YT-7420

27/54

- GB** Tool bag
D Werkzeugtasche
PL Torba na narzędzia
RUS Сумка для инструмента
- CZ** Taška montérská
H Szerszámos táska
RO Geanta pt. scule
F Sac à outils
- I** Borsa per attrezzi
E Bolso de herramientas
CN 工具包

600D
POLYESTER
POLYESTER



17
POCKETS
KIESZENI

RUBBER
BOTTOM
GUMOWY
SPÓD

YATO

YT-74360

8



15
POCKETS
KIESZENI

RUBBER
BOTTOM
GUMOWY
SPÓD

YATO

YT-74361

6



41
POCKETS
KIESZENI

YATO

YT-74351

4

- GB** Tool bag
D Werkzeugtasche
PL Torba na narzędzia
RUS Сумка для инструмента
- CZ** Taška montérská
H Szerszámos táska
RO Geanta pt. scule
F Sac à outils
- I** Borsa per attrezzi
E Bolso de herramientas
CN 工具包

HEAVY DUTY NYLON



50
POCKETS
KIESZENI

STEEL
EDGES
FRAMES

EASY OPEN

EASY CLOSE

YATO

YT-7430

12



16
POCKETS
KIESZENI

YATO

YT-7433

12

GB Open tote tool bag
D Werkzeugtrage
PL Pojemnik na narzędzia

RUS Контейнер для инструментов
CZ Přepravka na nářadí
H Szerszámartó csövazas

RO Geanta de otel pt. portbagaj
F Panier porte-outils
I Borsa portautensili

E Maletin de herramientas
CN 具包

600D
 POLYESTER
 POLYESTER



16
 POCKETS
 KIESZEN



9
 POCKETS
 KIESZEN

YATO
 YT-74370



6

YATO
 YT-74371



6



17
 POCKETS
 KIESZEN



11
 POCKETS
 KIESZEN

YATO
 YT-74372



6

YATO
 YT-74373



6

GB Steel tube tool carrier
D Werkzeugkoffer
PL Walizka narzędziowa
RUS Семодан для инструмента
CZ Taška na nářadí
H Szerszámartó csövázás

RO Geanta de otel pt. portbagaj
F Sac à outils
I Valigetta per attrezzi
E Maletin de herramientas
CN 钢管柄工具包

31
 POCKETS
 KIESZEN

HEAVY DUTY NYLON

GB Foldable chair with bag
D Werkzeugtasche mit Klappstuhl
PL Torba narzędziowa z krzeselkiem
RUS Стул складной с сумкой для инструмента
CZ Taška na nářadí se stojánkem
H Összecsukható szék tartózsebbel

RO Scaun rabatabil cu geanta
F Sac à outils + tabouret
I Sedia pieghevole per borsa attrezzi
E Bolso de herramientas con silla plegable
CN 帶包折疊椅

22
 POCKETS
 KIESZEN

HEAVY DUTY NYLON

90 kg



YATO
 YT-7435



4



YATO
 YT-7446



10

Memo

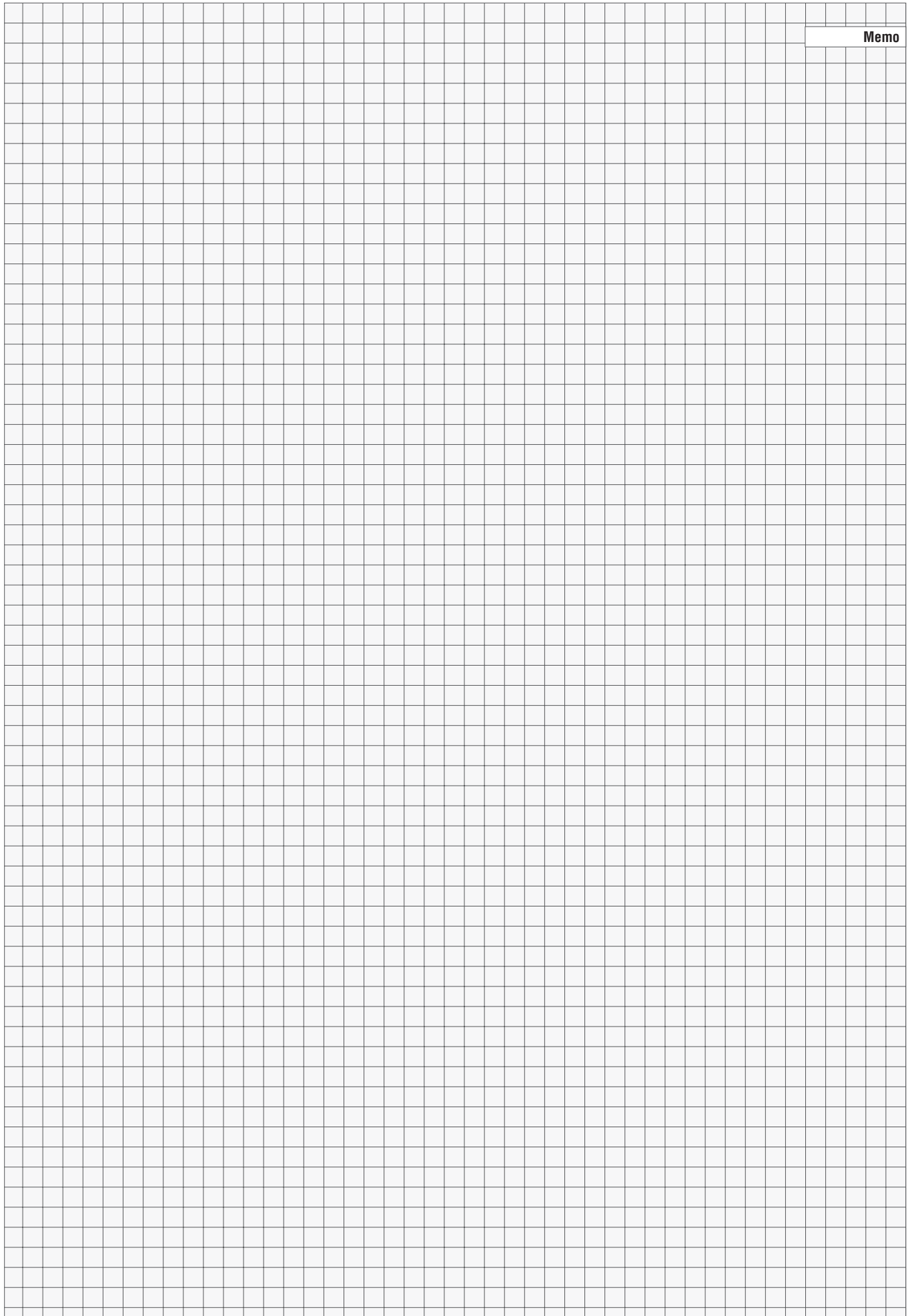

20

Health & safety articles
Artykuły BHP



Safety glasses
Okulary ochronne

424-425



Hearing protectors
Nauszniki przeciwhałasowe

429



Safety goggles
Gogle ochronne

425



Working shoes
Buty robocze

430-431



Working gloves
Rękawice robocze

426



Safety sandals

Sandały robocze..... 430

Low-cut safety shoes

Półbuty robocze..... 430

Middle-cut safety shoes

Trzewiki robocze..... 431

Knee pads
Nakolanniki

426



Working clothes

Odzież robocza

432-434



Disposable dust masks
Półmaski filtrujące

427-428



Vests

Kamizelki..... 432

Working jackets

Bluzy i kurtki robocze..... 432

Working trousers

Spodnie robocze..... 434

Working overalls

Spodnie robocze ogrodniczki..... 434

Ear plugs
Zatyczki do uszu

429



GB Safety glasses
D Schutzbrille
PL Okulary ochronne

RUS Очки защитные открытые
CZ Ochranné brýle
H Védőszemüveg

RO Ochelari pt. protectie
F Lunettes de protection
I Occhiali protettivi

E Gafas protectoras
CN 劳保眼镜



TYPE 90960 EN 166:2001 F

YT-7360	12/240



TYPE 9844 EN 166:2001 F

YT-7361	12/240



TYPE 91977 EN 166:2001 F

YT-7363	12/240



TYPE 91659 EN 166:2001 F

YT-7365	12/240



TYPE 91708 EN 166:2001 F

YT-7367	12/240



TYPE 91797 EN 166:2001 F

YT-7369	12/240



TYPE 91692 EN 166:2001 F

YT-7371	12/240



TYPE B524 EN 166:2001 F

YT-73631	12/300



TYPE B532 EN 166:2001 F

YT-73761	12/300



TYPE 9844 EN 166:2001 F

YT-7362	12/240



TYPE 91977 EN 166:2001 F

YT-7364	12/240



TYPE 91659 EN 166:2001 F

YT-7366	12/240



TYPE 91708 EN 166:2001 F

YT-7368	12/240



TYPE 91293 EN 166:2001 F

YT-7374	12/240



TYPE 91380 EN 166:2001 F

YT-7376	12/240



TYPE B517 EN 166:2001 F

YT-73641	12/300



TYPE B510 EN 166:2001 EN 169:2002

YT-73744	12/300



TYPE B532 EN 166:2001 F

YT-73760	12/300

GB Safety glasses
D Schutzbrille
PL Okulary ochronne
RUS Очки защитные открытые
CZ Ochranné brýle
H Védőszemüveg

RO Ochelari pt. protectie
F Lunettes de protection
I Occhiali protettivi
E Gafas protectoras
CN 劳保眼镜

POLYBAG WITH
HEADER



TYPE 92281 EN 166:2001 F

YATO 	
YT-73602	12/240



TYPE 92218SR EN 166:2001 F

YATO 	
YT-73700	12/240



TYPE 92281 EN 166:2001 F

YATO 	
YT-73603	12/240



TYPE 92218SR EN 166:2001 F

YATO 	
YT-73701	12/240

GB Safety goggles
with strap
D Schutzbrille
PL Gogle ochronne
z paskiem

RUS Очки защитные
CZ Ochranné brýle
H Védőszemüveg
RO Ochelari pt. protectie

F Lunettes masque
de protection
I Occhiali protettivi
con cinghia

E Gafas protectoras
CN 劳保眼镜

POLYBAG WITH
HEADER



ANTI-FOG
COATED
ODPORNE
NA
ZAMGLIENIA

ANTI-SCRATCH
PROTECTION
ODPORNE NA
ZARYSOWANIA



TYPE 92275 EN 166:2001 F

YATO 	
YT-73765	12/240



TYPE 92275 EN 166:2001 F

YATO 	
YT-73766	12/240

GB Safety goggles
D Schutzbrille
PL Gogle ochronne
RUS Очки защитные
CZ Ochranné brýle
H Védőszemüveg
RO Ochelari pt. protectie

F Lunettes masque
de protection
I Occhiali protettivi
a mascherina
E Gafas protectoras
CN 劳保眼镜

PAPER
HANGING
CARD





TYPE 2876 EN 166:2001 F

YATO 	
YT-7377	12/120



TYPE #2769 EN 166:2001 F

YATO 	
YT-7380	20/200





TYPE SG90B EN 166:2001 F

YATO 	
YT-7381	20/200



TYPE SG-60 EN 166:2001 B

YATO 	
YT-7382	10/100



TYPE TW2015 EN 166:2001 B

YATO 	
YT-7383	10/100



TYPE B608 EN 166:2001 B

YATO 	
YT-73801	10/100



TYPE B421 EN 166:2001 B

YATO 	
YT-73830	10/100

GB Working gloves
 D Arbeitshandschuh
 PL Rękawice robocze
 RUS Рабочие перчатки
 CZ Pracovní rukavice
 H Védőkesztyű
 RO Mănuși de lucru
 F Gants de travail
 I Guanti da lavoro
 E Guantes de piel
 CN 劳保手套



NYLON
PU
 4131 EN 388

YATO	size / rozmiar	
YT-7470	10	50/100



PAPER
 HEADER



NYLON
PU
 4131 EN 388

YATO	size / rozmiar	
YT-7472	10	50/100



NYLON
PU
 4131 EN 388

YATO	size / rozmiar	
YT-7473	10	50/100



NYLON
NITRYLIT
 3121 EN 388

YATO	size / rozmiar	
YT-7474	10	50/100



PE
NITRYLIT
 4111 EN 388

YATO	size / rozmiar	
YT-7480	9	12/120
YT-7481	10	12/120



COTTON
BAWELNA
LATEX
LATEKS
 2243 EN 388

YATO	size / rozmiar	
YT-7471	10	12/120

GB Gel knee pads
 D Gel Knieschoner
 PL Nakolanniki żelowe
 RUS Гелевые наколенники
 CZ Nákoleníky gelové
 H Térdvédő zselés
 RO Genunchiere
 cu protecție de silicon
 F Genouillères
 à coussinets de gel
 I Protettore per ginocchio
 E Protectores
 de gel para
 rodillas
 CN 护膝



DISPLAY
 COLOR BOX



GEL
SUPPORT



YATO	
YT-7460	12

YATO	
YT-7461	12

- GB** Disposable dust masks
D Atemschutzmaske
PL Półmaski filtrujące jednorazowe
RUS Респиратор противопылевой одноразовый
CZ Protiprašná maska
H Eldobható porvédőmaszk
RO Masca praф
F Demi-masques de filtration
I Maschera filtra polvere
E Mascarilla desechable para protección contra polvo
CN 防尘面罩

2
PCS

FFP1 NR



POLYBAG
WITH HEADER



YATO  
YT-74852 50

- GB** Disposable dust masks
D Atemschutzmaske
PL Półmaski filtrujące jednorazowe
RUS Респиратор противопылевой одноразовый
CZ Protiprašná maska
H Eldobható porvédőmaszk
RO Masca praф
F Demi-masques de filtration
I Maschera filtra polvere
E Mascarilla desechable para protección contra polvo
CN 防尘面罩

3
PCS

FFP1 NR



POLYBAG
WITH HEADER



YATO  
YT-7485 25/100

- GB** Disposable dust mask with valve
D Atemschutzmaske mit Ventil
PL Półmaska filtrująca jednorazowa z zaworem
RUS Респиратор противопылевой одноразовый с клапаном
CZ Protiprašná maska s ventilem
H Eldobható porvédőmaszk, szelepes
RO Masca praф cu valva
F Demi-masques de filtration
I Maschera respiratoria con valvola di espirazione
E Mascarilla desechable para protección contra polvo
CN 带阀防尘面罩

FFP1 NR



POLYBAG
WITH HEADER



YATO  
YT-74862 50

- GB** Disposable dust masks with valve
D Atemschutzmaske mit Ventil
PL Półmaski filtrujące jednorazowe z zaworem
RUS Респиратор противопылевой одноразовый с клапаном
CZ Protiprašná maska s ventilem
H Eldobható porvédőmaszk, szelepes
RO Masca praф cu valva
F Demi-masques de filtration
I Maschera respiratoria con valvola di espirazione
E Mascarilla desechable para protección contra polvo
CN 带阀防尘面罩



3
PCS

FFP1 NR



POLYBAG
WITH HEADER



YATO  
YT-7486 25/100

- GB** Disposable dust masks
D Atemschutzmaske
PL Półmaski filtrujące jednorazowe
RUS Респиратор противопылевой одноразовый
CZ Protiprašná maska
H Eldobható porvédőmaszk
RO Masca praф
F Demi-masques de filtration
I Maschera filtra polvere
E Mascarilla desechable para protección contra polvo
CN 防尘面罩



3
PCS

FFP1 NR



POLYBAG
WITH HEADER



YATO  
YT-74870 50

- GB** Disposable dust masks with valve
D Atemschutzmaske mit Ventil
PL Półmaski filtrujące jednorazowe z zaworem
RUS Респиратор противопылевой одноразовый с клапаном
CZ Protiprašná maska s ventilem
H Eldobható porvédőmaszk, szelepes
RO Masca praф cu valva
F Demi-masques de filtration
I Maschera respiratoria con valvola di espirazione
E Mascarilla desechable para protección contra polvo
CN 带阀防尘面罩

3
PCS

FFP1 NR



POLYBAG
WITH HEADER



YATO  
YT-7488 25/100

GB Disposable dust masks
D Atemschutzmaske
PL Półmaski filtrujące jednorazowe
RUS Респиратор противопылевой одноразовый
CZ Protiprašná maska
H Eldobható porvédőmaszk
RO Masca praaf
F Demi-masques de filtration
I Maschera filtra polvere
E Mascarilla desechable para protección contra polvo
CN 防尘面罩

3
PCS
FFP2 NR



POLYBAG WITH HEADER

YATO
YT-74916 50

GB Disposable dust masks with valve
D Atemschutzmaske mit Ventil
PL Półmaski filtrujące jednorazowe z zaworem
RUS Респиратор противопылевой одноразовый с клапаном
CZ Protiprašná maska s ventilem
H Eldobható porvédőmaszk, szelepes
RO Masca praaf cu valva
F Demi-masques de filtration
I Maschera respiratoria con valvola di espirazione
E Mascarilla desechable para protección contra polvo
CN 带阀防尘面罩

3
PCS
FFP2 NR



POLYBAG WITH HEADER

YATO
YT-74917 50

GB Disposable dust masks with valve
D Atemschutzmaske mit Ventil
PL Półmaski filtrujące jednorazowe z zaworem
RUS Респиратор противопылевой одноразовый с клапаном
CZ Protiprašná maska s ventilem
H Eldobható porvédőmaszk, szelepes
RO Masca praaf cu valva
F Demi-masques de filtration
I Maschera respiratoria con valvola di espirazione
E Mascarilla desechable para protección contra polvo
CN 带阀防尘面罩

3
PCS
FFP2 NR



POLYBAG WITH HEADER

YATO
YT-7492 15/60

GB Disposable dust masks
D Atemschutzmaske
PL Półmaski filtrujące jednorazowe
RUS Респиратор противопылевой одноразовый
CZ Protiprašná maska
H Eldobható porvédőmaszk
RO Masca praaf
F Demi-masques de filtration
I Maschera filtra polvere
E Mascarilla desechable para protección contra polvo
CN 防尘面罩

2
PCS
FFP2 NR



POLYBAG WITH HEADER

YATO
YT-74919 50

GB Disposable dust mask with valve
D Atemschutzmaske mit Ventil
PL Półmaska filtrująca jednorazowa z zaworem
RUS Респиратор противопылевой одноразовый с клапаном
CZ Protiprašná maska s ventilem
H Eldobható porvédőmaszk, szelepes
RO Masca praaf cu valva
F Demi-masques de filtration
I Maschera respiratoria con valvola di espirazione
E Mascarilla desechable para protección contra polvo
CN 带阀防尘面罩

FFP2 NR



POLYBAG WITH HEADER

YATO
YT-74949 50

GB Ear plugs
D Gehörschutz
PL Zatycki do uszu
RUS Средства защиты слуха
CZ Chrániče sluchu
H Fülvédőt
RO Antifoane
F Bouchons anti-bruit
I Tappi per orecchie
E Tapones para los oídos
CN 耳塞

SNR
34 dB



POLYBAG
WITH HEADER

SNR
28 dB



POLYBAG
WITH HEADER

SNR
22 dB



POLYBAG
WITH HEADER

5
PAIRS
PAR

5
PAIRS
PAR

5
PAIRS
PAR

YATO	size / rozmiar (mm)	pairs / pary	
YT-7451	7-12	5	25/500

YATO	size / rozmiar (mm)	pairs / pary	
YT-7453	8-13	5	25/500

YATO	size / rozmiar (mm)	pairs / pary	
YT-7455	8-12	5	25/500



POLYBAG

WHITE CARTON BOX
& COLOR LABEL



50 PCS



SNR
34 dB

200
PAIRS
PAR

POLYBAG

DISPLAY
COLOR BOX



200 PCS



POLYBAG

WHITE CARTON BOX
& COLOR LABEL



50 PCS



SNR
28 dB

SNR
22 dB

50
PAIRS
PAR

YATO	size / rozmiar (mm)	pairs / pary	
YT-7454	8-12	50	20

YATO	size / rozmiar (mm)	pairs / pary	
YT-74510	7-12	200	20

YATO	size / rozmiar (mm)	pairs / pary	
YT-7456	8-10	50	20

GB Ear plugs
D Gehörschutz
PL Zatycki do uszu na pałąku
RUS Средства защиты слуха
CZ Chrániče sluchu
H Fülvédőt
RO Antifoane
F Arceau antibruit
avec bouchons
I Tappi per orecchie
auricolari
E Tapones para
los oídos
CN 耳塞



SNR
21 dB

YATO	
YT-7458	25/500



POLYBAG
WITH
HEADER



SNR
26 dB

YATO	
YT-7459	25/500

GB Hearing protectors
D Gehörschutz
PL Nauszniki przeciwhałasowe
RUS Средства защиты слуха
CZ Chrániče sluchu
H Fülvédőt
RO Antifoane
F Casque anti-bruit
I Cuffie antirumore
E Protectores auditivos
CN 耳罩

POLYBAG
WITH
HEADER



SNR
26 dB

YATO	
YT-7462	40



SNR
26 dB

YATO	
YT-7463	20



SNR
27 dB

YATO	
YT-74621	60

GB Safety sandals
D Arbeitshalschuhe
PL Sandały robocze
RUS Полуботинки рабочие

CZ Pracovní polobotky
H Munkavédelmi félcipő
RO Bocanci de lucru
F Sandale de sécurité

I Sandalo da lavoro
E Zapato de trabajo
CN 劳保鞋

RED CARTON BOX
& COLOR LABEL



SEGURA

INSOLE & MESH COATED EVA
WKŁADKA I WYŚCIOŁKA Z MATERIAŁU EVA



SHOCK ABSORBER
AMORTYZATOR DRGAŃ



COMPOSITE TOE CUP
KOMPOZYTOWY NOSEK

PU OVERCUP
PODESZWA Z POLIURETANU Z NOSKIEM

YATO	size / rozmiar	
YT-80460	36	10
YT-80461	37	10
YT-80462	38	10
YT-80463	39	10
YT-80464	40	10
YT-80465	41	10
YT-80466	42	10
YT-80467	43	10
YT-80468	44	10
YT-80469	45	10
YT-80470	46	10
YT-80471	47	10

GB Low-cut safety shoes
D Arbeitshalschuhe
PL Półbuty robocze
RUS Полуботинки рабочие

CZ Pracovní polobotky
H Munkavédelmi félcipő
RO Bocanci de lucru
F Chaussure de sécurité

I Scarpe da lavoro
E Zapato de trabajo
CN 劳保鞋

RED CARTON BOX
& COLOR LABEL



PUNO

INSOLE & MESH COATED EVA
WKŁADKA I WYŚCIOŁKA Z MATERIAŁU EVA



SHOCK ABSORBER
AMORTYZATOR DRGAŃ



STALOWY NOSEK
STEEL TOE CAP
PU SOLE
PODESZWA Z POLIURETANU



INSOLE & MESH COATED EVA
WKŁADKA I WYŚCIOŁKA Z MATERIAŁU EVA



SHOCK ABSORBER
AMORTYZATOR DRGAŃ



STALOWY NOSEK
STEEL TOE CAP
PU SOLE
PODESZWA Z POLIURETANU



YATO	size / rozmiar	
YT-80521	39	10
YT-80522	40	10
YT-80523	41	10
YT-80524	42	10
YT-80525	43	10
YT-80526	44	10
YT-80527	45	10
YT-80528	46	10
YT-80529	47	10

YATO	size / rozmiar	
YT-80572	39	10
YT-80573	40	10
YT-80574	41	10
YT-80575	42	10
YT-80576	43	10
YT-80577	44	10
YT-80578	45	10
YT-80579	46	10
YT-80580	47	10

INSOLE & MESH COATED EVA
WKŁADKA I WYŚCIOŁKA Z MATERIAŁU EVA



SHOCK ABSORBER
AMORTYZATOR DRGAŃ



STALOWY NOSEK
STEEL TOE CAP
PU SOLE
PODESZWA Z POLIURETANU



INSOLE & MESH COATED EVA
WKŁADKA I WYŚCIOŁKA Z MATERIAŁU EVA



SHOCK ABSORBER
AMORTYZATOR DRGAŃ



STALOWY NOSEK
STEEL TOE CAP
PU SOLE
PODESZWA Z POLIURETANU



YATO	size / rozmiar	
YT-80552	39	10
YT-80553	40	10
YT-80554	41	10
YT-80555	42	10
YT-80556	43	10
YT-80557	44	10
YT-80558	45	10
YT-80559	46	10
YT-80560	47	10

YATO	size / rozmiar	
YT-80583	39	10
YT-80584	40	10
YT-80585	41	10
YT-80586	42	10
YT-80587	43	10
YT-80588	44	10
YT-80589	45	10
YT-80590	46	10
YT-80591	47	10

GB Middle-cut safety shoes
D Arbeitsschnürschuhe
PL Trzewiki robocze
RUS Ботинки рабочие

CZ Pracovní boty šněrovací
H Munkavédelmi bakancs
RO Pantof de lucru
F Chaussure de sécurité

I Scarpe da lavoro
E Calzado de trabajo
CN 劳保鞋

RED CARTON BOX
& COLOR LABEL



INSOLE & MESH COATED EVA
WKŁADKA I WYSIÓŁKA Z MATERIAŁU EVA



SHOCK ABSORBER
AMORTYZATOR DRGAŃ



TRAT

STEEL TOE CAP
STALOWY NOSEK

PU SOLE
PODESZWA Z POLIURETANU



INSOLE & MESH COATED EVA
WKŁADKA I WYSIÓŁKA Z MATERIAŁU EVA



SHOCK ABSORBER
AMORTYZATOR DRGAŃ



TABAR

STEEL TOE CAP
STALOWY NOSEK

PU SOLE
PODESZWA Z POLIURETANU



YATO	size / rozmiar	☐
YT-80733	39	10
YT-80734	40	10
YT-80735	41	10
YT-80736	42	10
YT-80737	43	10
YT-80738	44	10
YT-80739	45	10
YT-80740	46	10
YT-80741	47	10

YATO	size / rozmiar	☐
YT-80761	39	10
YT-80762	40	10
YT-80763	41	10
YT-80764	42	10
YT-80765	43	10
YT-80766	44	10
YT-80767	45	10
YT-80768	46	10
YT-80769	47	10

INSOLE & MESH COATED EVA
WKŁADKA I WYSIÓŁKA Z MATERIAŁU EVA



SHOCK ABSORBER
AMORTYZATOR DRGAŃ



TENDA

STEEL TOE CAP
STALOWY NOSEK

PU OVERCUP
PODESZWA Z POLIURETANU Z NOSKIEM

PU SOLE
PODESZWA Z POLIURETANU



INSOLE & MESH COATED EVA
WKŁADKA I WYSIÓŁKA Z MATERIAŁU EVA



SHOCK ABSORBER
AMORTYZATOR DRGAŃ



TEZU

STEEL TOE CAP
STALOWY NOSEK

PU SOLE
PODESZWA Z POLIURETANU



YATO	size / rozmiar	☐
YT-80852	39	10
YT-80853	40	10
YT-80854	41	10
YT-80855	42	10
YT-80856	43	10
YT-80857	44	10
YT-80858	45	10
YT-80859	46	10
YT-80860	47	10

YATO	size / rozmiar	☐
YT-80841	39	10
YT-80842	40	10
YT-80843	41	10
YT-80844	42	10
YT-80845	43	10
YT-80846	44	10
YT-80847	45	10
YT-80848	46	10
YT-80849	47	10

INSOLE & MESH COATED EVA
WKŁADKA I WYSIÓŁKA Z MATERIAŁU EVA



SHOCK ABSORBER
AMORTYZATOR DRGAŃ



TOLU

STEEL TOE CAP
STALOWY NOSEK

PU SOLE
PODESZWA Z POLIURETANU



INSOLE & MESH COATED EVA
WKŁADKA I WYSIÓŁKA Z MATERIAŁU EVA



SHOCK ABSORBER
AMORTYZATOR DRGAŃ



TWER

STEEL TOE CAP
STALOWY NOSEK

PU SOLE
PODESZWA Z POLIURETANU



YATO	size / rozmiar	☐
YT-80794	39	10
YT-80795	40	10
YT-80796	41	10
YT-80797	42	10
YT-80798	43	10
YT-80799	44	10
YT-80800	45	10
YT-80801	46	10
YT-80802	47	10

YATO	size / rozmiar	☐
YT-80783	39	10
YT-80784	40	10
YT-80785	41	10
YT-80786	42	10
YT-80787	43	10
YT-80788	44	10
YT-80789	45	10
YT-80790	46	10
YT-80791	47	10

- GB** Insulated vest **CZ** Vesta
D Gepolsterte Weste **H** Bélelt mellény
PL Bezrękawnik ocieplany **RO** Vestă vătuită
RUS Утепленный жилет **F** Gilet matelassé

100% POLYESTER
PVC COATED
100% POLYESTER
POWLODKA PVC

- GB** Fleece jacket **CZ** Fleecová bunda **I** Giacca in pile
D Fleece-Jacke **H** Fleece dzseki **E** Chaqueta polar
PL Bluza polarowa **RO** Bluză polară **CN** 摇粒绒夹克
RUS Флисовая кофта **F** Veste polaire



POLAR
350g/m²



POLYBAG



DUGO



YATO 	size / rozmiar	
YT-80355	S	20
YT-80356	M	20
YT-80357	L	20
YT-80358	XL	20
YT-80359	XXL	20



POLYBAG



DURANGO BLACK

YATO 	size / rozmiar	
YT-80360	S	12
YT-80361	M	12
YT-80362	L	12
YT-80363	XL	12
YT-80364	XXL	12

- GB** Fleece jacket **CZ** Fleecová bunda **I** Giacca in pile
D Fleece-Jacke **H** Fleece dzseki **E** Chaqueta polar
PL Bluză polară **RO** Bluză polară **CN** 摇粒绒夹克
RUS Флисовая кофта **F** Veste polaire

POLAR
350g/m²

- GB** Softshell jacket **CZ** Softshellová bunda **I** Giacca softshell
D Softshell-Jacke **H** Softshell dzseki **E** Chaqueta softshell
PL Kurtka softshell **RO** Jacheta softshell **CN** 冲锋夹克
RUS Softshell куртка **F** Veste softshell



96% POLYESTER
4% SPANDEX
96% POLYESTER
4% SPANDEX



POLYBAG



DURANGO GREY



YATO 	size / rozmiar	
YT-80365	S	8
YT-80366	M	8
YT-80367	L	8
YT-80368	XL	8
YT-80369	XXL	8



POLYBAG



DEZ

YATO 	size / rozmiar	
YT-80390	S	10
YT-80391	M	10
YT-80392	L	10
YT-80393	XL	10
YT-80394	XXL	10

GB Working jacket
D Arbeitsjacke
PL Bluza robocza
RUS Рабочая рубашка

CZ Pracovní blůza
H Munkaruha felső
RO Bluză de lucru
F Blouson de travail

I Felpa da lavoro
E Blusa de trabajo
CN 工作服

65% POLYESTER
35% COTTON
65% POLYESTER
35% BAWELNA

GB Working jacket
D Arbeitsjacke
PL Bluza robocza
RUS Рабочая рубашка

CZ Pracovní blůza
H Munkaruha felső
RO Bluză de lucru
F Blouson de travail

I Felpa da lavoro
E Blusa de trabajo
CN 工作服

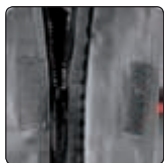

65% POLYESTER
35% COTTON
65% POLYESTER
35% BAWELNA



POLYBAG
WITH PLASTIC
HANGER



DAN

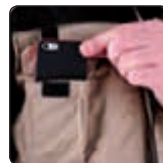

YATO 	size / rozmiar	
YT-80280	S	10
YT-80281	M	10
YT-80282	L	10
YT-80283	XL	10
YT-80284	XXL	10



POLYBAG
WITH PLASTIC
HANGER



DOHAR

YATO 	size / rozmiar	
YT-80435	S	20
YT-80436	M	20
YT-80437	L	20
YT-80438	XL	20
YT-80439	XXL	20

GB Jacket
D Jacke
PL Kurtka
RUS Куртка

CZ Bunda
H Dzseki
RO Jacheta
F Veste

I Giacca
E Chaqueta
CN 夹克

100% POLYESTER
PVC COATED
100% POLYESTER
POWLODKA PVC

POLAR
220 g/m²

3 in 1
3 w 1

GB Working jacket
D Arbeitsjacke
PL Bluza robocza
RUS Рабочая рубашка

CZ Pracovní blůza
H Munkaruha felső
RO Bluză de lucru
F Blouson de travail

I Felpa da lavoro
E Blusa de trabajo
CN 工作服



65% POLYESTER
35% COTTON
65% POLYESTER
35% BAWELNA



POLYBAG



DORRA



YATO 	size / rozmiar	
YT-80380	S	10
YT-80381	M	10
YT-80382	L	10
YT-80383	XL	10
YT-80384	XXL	10



POLYBAG



DUERO

YATO 	size / rozmiar	
YT-8020	S	20
YT-8021	M	20
YT-8022	L	20
YT-8023	XL	20
YT-8024	XXL	20

GB Working trousers
D Arbeitshosen
PL Spodnie robocze
RUS Рабочие брюки



CZ Pracovní kalhoty
H Munkaruha nadrág
RO Pantaloni de lucru
F Pantalon de travail

I Pantalone da lavoro
E Pantalón de trabajo
CN 工作服

65% POLYESTER
35% COTTON
65% POLYESTER
35% BAWELNA



DUERO

YATO 	size / rozmiar	
YT-8025	S	20
YT-8026	M	20
YT-8027	L	20
YT-8028	XL	20
YT-8029	XXL	20

GB Working trousers
D Arbeitshosen
PL Spodnie robocze
RUS Рабочие брюки

CZ Pracovní kalhoty
H Munkaruha nadrág
RO Pantaloni de lucru
F Pantalon de travail

I Pantalone da lavoro
E Pantalón de trabajo
CN 工作服



65% POLYESTER
35% COTTON
65% POLYESTER
35% BAWELNA



POLYBAG
WITH PLASTIC
HANGER



DAN

YATO 	size / rozmiar	
YT-80285	S	10
YT-80286	M	10
YT-80287	L	10
YT-80288	XL	10
YT-80289	XXL	10



GB Working overalls
D Arbeitshosen, Gärtnerin
PL Spodnie robocze ogrodniczki
RUS Рабочий полукombineзон
CZ Pracovní kalhoty lačlové
H Kertész nadrág

RO Pantaloni de lucru grădină
F Salopette de travail
I Salopette da lavoro
E Pantalón de trabajo tipo jardinero
CN 工作服

65% POLYESTER
35% COTTON
65% POLYESTER
35% BAWELNA



DUERO

YATO 	size / rozmiar	
YT-8030	S	20
YT-8031	M	20
YT-8032	L	20
YT-8033	XL	20
YT-8034	XXL	20

GB Working overalls
D Arbeitshosen, Gärtnerin
PL Spodnie robocze ogrodniczki
RUS Рабочий полукombineзон
CZ Pracovní kalhoty lačlové
H Kertész nadrág

RO Pantaloni de lucru grădină
F Salopette de travail
I Salopette da lavoro
E Pantalón de trabajo tipo jardinero
CN 工作服

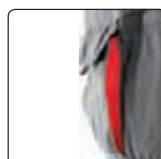

65% POLYESTER
35% COTTON
65% POLYESTER
35% BAWELNA



POLYBAG
WITH PLASTIC
HANGER



DAN

YATO 	size / rozmiar	
YT-80290	S	10
YT-80291	M	10
YT-80292	L	10
YT-80293	XL	10
YT-80294	XXL	10

Memo

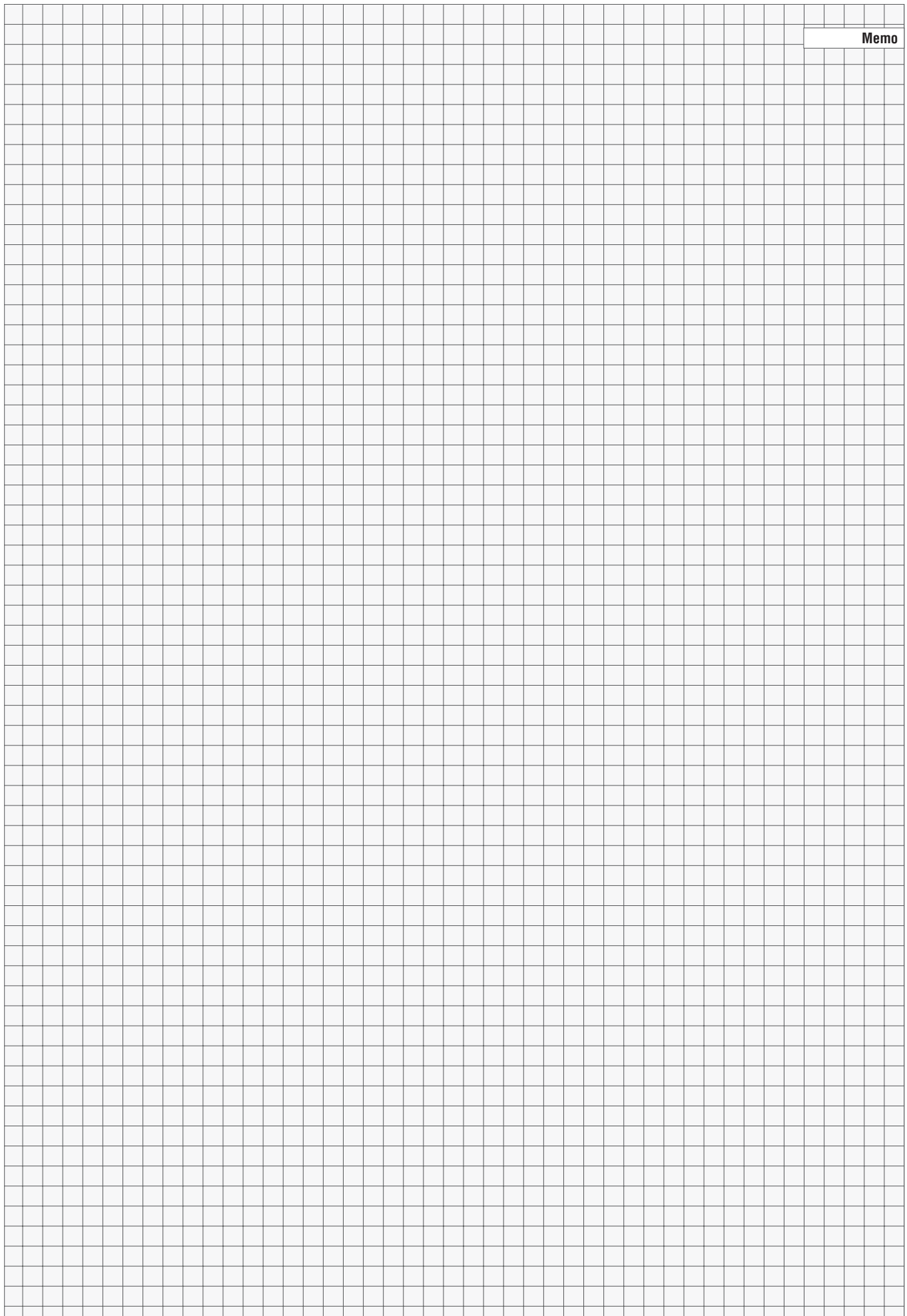

21

Electric products Artykuły elektryczne



Ceiling & wall lamps
Oprawy sufitowe i ściennie

438-441



Workshop lightning
Oświetlenie warsztatowe

445-449



Floodlights
Naświetlacze

441-444



Flashlights
Latarki

449-450



Solar lamps
Oprawy solarne

444-445



Extension cords
Przedłużacze elektryczne

451



- GB** LED ceiling light
- D** LED-Deckenleuchte
- PL** Oprawa sufitowa LED
- RUS** Потолочный светодиодный светильник
- CZ** Stropní LED svítidlo
- H** Mennyezeti LED lámpatest
- RO** Corp de iluminat pt. tavan LED
- F** Lumiere de plafond a LED
- I** Plafoniera LED
- E** Luz de techo del LED
- CN** LED 吸顶灯



GREY CARTON BOX & COLOR LABEL



220-240 V~
50/60 Hz

40W

216 LED

4000 lm

4000 K

120°

Ra>80

YATO	W	lm	size / rozmiar (mm)	
YT-81948	40	4000	595 x 595	5

- GB** LED ceiling light
- D** LED-Deckenleuchte
- PL** Oprawa sufitowa LED
- RUS** Потолочный светодиодный светильник
- CZ** Stropní LED svítidlo
- H** Mennyezeti LED lámpatest
- RO** Corp de iluminat pt. tavan LED
- F** Lumiere de plafond a LED
- I** Plafoniera LED
- E** Luz de techo del LED
- CN** LED 吸顶灯



GREY CARTON BOX & COLOR LABEL



230V~
50Hz

4000 K

120°

50000 h

IP20



40W

112 LED

3100 lm

YATO	W	lm	size / rozmiar (mm)	
YT-81943	40	3100	595 x 595 x 15	5

40W

112 LED

3000 lm

YATO	W	lm	size / rozmiar (mm)	
YT-81947	40	3000	300 x 1200 x 15	4

18W

80 LED

1150 lm



YATO	W	lm	size / rozmiar (mm)	
YT-81941	18	1150	300 x 300 x 15	10

- GB** Mounting brackets for plaster-board ceiling
- D** Montagehalterungen für Gipskartondecke
- PL** Zestaw uchwytyw do płyt kartonowo-gipsowych
- RUS** Монтажные кронштейны для потолочных светильников
- CZ** Montážní konzoly na sádkarton strop
- H** Rögzítőelemek mert gipszkarton mennyezet

- RO** Maner pt. multi-caseta gips
- F** Supports de montage pour plafonds en plâtre
- I** Set di attacchi per lastre in cartongesso
- E** Soportes de montaje para techo de escayola
- CN** 吸顶灯安装支架



POLYBAG



YATO	
YT-81951	20

- GB** Hanging wires set for suspended fittings
- D** Stahlseilaufrichtung für Lampen
- PL** Oprawa sufitowa LED
- RUS** Zestaw linek do zawieszania opraw
- CZ** Kit závěsných lanek pro zavěšení světla
- H** Lámpa függesztődrot
- RO** Set de fire pt. montaj suspendate
- F** Ensemble de suspension pour luminaires
- I** Set di fili per appendere apparecchi a sospensione
- E** Suspensiones con cable para lámparas
- CN** 吸顶灯安装五金件

POLYBAG



YATO	
YT-81952	200

GB Waterproof lamp LED
D Wasserdichte lampe LED
PL Oprawa hermetyczna LED
RUS Светильник светодиодный герметичный
CZ Vodotěsné a prachotěsné svítidlo LED
H Vízálló lámpa LED

RO Lampa LED impermeabilă
F Plafonnier LED étanche
I Plafoniera stagna LED
E Lámpara hermética LED
CN 三防灯

GREY CARTON BOX
& COLOR LABEL



SMD



220-240 V~
50/60 Hz

4000K



120°

IP65

POLYCARBONATE
DIFFUSER
KOSZUL Z POLIWEŚLANU





20W **1800**
lm

YATO 	W	lm	size / rozmiar (mm)	
YT-81960	20	1800	600x80	12





40W **3600**
lm

YATO 	W	lm	size / rozmiar (mm)	
YT-81961	40	3600	1200x80	8



50W **4500**
lm

YATO 	W	lm	size / rozmiar (mm)	
YT-81962	50	4500	1500x80	8

GB Wall lamp
D Wandleuchte
PL Lampa ścienna
RUS Светильник настенный
CZ Nástěnné svítidlo
H Fali lámpa
RO Lampă de perete
F Applique
I Lampada da parete
E Lámpara de pared
CN 壁灯

COLOR BOX



SMD

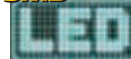

15W

230V~
50Hz

850
lm



4000K

120°



IP54



OUTDOOR LAMP
LAMPĂ ZEWNĘTRZNA



YATO 	W	lm	size / rozmiar (mm)	
YT-81840	15	850	260	12

OUTDOOR LAMP
LAMPĂ ZEWNĘTRZNA



YATO 	W	lm	size / rozmiar (mm)	
YT-81841	15	850	260	12



OUTDOOR LAMP
LAMPĂ ZEWNĘTRZNA

YATO 	W	lm	size / rozmiar (mm)	
YT-81842	15	850	285 x 170	12

OUTDOOR LAMP
LAMPĂ ZEWNĘTRZNA

YATO 	W	lm	size / rozmiar (mm)	
YT-81843	15	850	285 x 170	12

GB Wall lamp
D Wandleuchte
PL Lampa naścienna
RUS Светильник настенный

CZ Nástěnné svítidlo
H Fali lámpa
RO Lampă de perete
F Applique

I Lampada da parete
E Lámpara de pared
CN 壁灯

COLOR BOX



SMD



220-240 V~
50/60 Hz

120°

IP20



12W

840
lm

3000 K

12W

840
lm

4000 K



18W

1260
lm

3000 K



YATO	W	lm	size / rozmiar (mm)	
YT-81844	12	840	290	10

YATO	W	lm	size / rozmiar (mm)	
YT-81845	12	840	290	10

YATO	W	lm	size / rozmiar (mm)	
YT-81846	18	1260	330	10



18W

1260
lm

4000 K

24W

1680
lm

3000 K



24W

1680
lm

4000 K



YATO	W	lm	size / rozmiar (mm)	
YT-81847	18	1260	330	10

YATO	W	lm	size / rozmiar (mm)	
YT-81848	24	1680	385	5

YATO	W	lm	size / rozmiar (mm)	
YT-81849	24	1680	385	5

GB Wall lamp
D Wandleuchte
PL Lampa naścienna
RUS Светильник настенный
CZ Nástěnné svítidlo
H Fali lámpa

RO Lampă de perete
F Applique
I Lampada da parete
E Lámpara de pared
CN 壁灯

COLOR BOX



SMD



230V~
50Hz

4000 K

120°

20000 h

IP54



8W

650
lm



12W

860
lm



YATO	W	lm	size / rozmiar (mm)	
YT-81834	8	650	165 x 115	24

YATO	W	lm	size / rozmiar (mm)	
YT-81835	12	860	222 x 143	12

- GB** Wall lamp
D Wandleuchte
PL Lampa naścienna
RUS Светильник настенный
CZ Nástěnné svítidlo
H Fali lámpa
RO Lampă de perete
F Applique
I Lampada da parete
E Lámpara de pared
CN 壁灯



GU10 OUTDOOR LAMP
1 x 35W max. LAMPA ZEWNĘTRZNA

YATO	
YT-81900	20

COLOR BOX



220-240 V-50 Hz

IP44



GU10 OUTDOOR LAMP
1 x 35W max. LAMPA ZEWNĘTRZNA

YATO	
YT-81901	20



GU10 OUTDOOR LAMP
2 x 35W max. LAMPA ZEWNĘTRZNA

YATO	
YT-81902	12



GU10 OUTDOOR LAMP
2 x 35W max. LAMPA ZEWNĘTRZNA

YATO	
YT-81903	12



GU10 OUTDOOR LAMP
2 x 35W max. LAMPA ZEWNĘTRZNA

YATO	
YT-81904	12

- GB** Garden light with spike
D Gartenleuchte mit Erdspiess
PL Reflektor ogrodowy ze szpikulcem
RUS Светильник садовый
CZ Zahradní svítidlo
H Kerti tűske fényvető
RO Lampa gradina cu pivot
F Lampe de jardin
I Lampada da giardino con punta
E Reflector de jardín
CN 地插灯

220-240 V-50 Hz

GU10
35W max.

AI

IP54



OUTDOOR LAMP
LAMPA ZEWNĘTRZNA



COLOR BOX



YATO	
YT-81775	8

- GB** LED lamp
D Diodenscheinwerfer
PL Reflektor diodowy
RUS Светодиодный прожектор
CZ LED reflektor
H Diódás reflektor
RO Reflector diodă
F Projecteur LED
I Faretto LED
E Reflector de diodos
CN 工作灯

10W

700 lm

6000 K

230V~50Hz

20000 h

IP65

COB

LED



COLOR BOX



YATO	
YT-81800	18

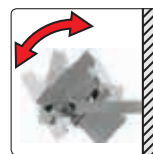

- GB** LED lamp
D Diodenscheinwerfer
PL Reflektor diodowy
RUS Светодиодный прожектор
CZ LED reflektor
H Diódás reflektor
RO Reflector diodă
F Projecteur LED
I Faretto LED
E Reflector de diodos
CN 工作灯

20W

1400 lm

6000 K

230V~50Hz

20000 h

IP65

COB

LED



COLOR BOX



YATO	
YT-81797	16

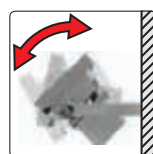

GB LED lamp
D Diodenscheinwerfer
PL Reflektor diodowy
RUS Светодиодный прожектор
CZ LED reflektor
H Diódás reflektor
RO Reflector diodă
F Projecteur LED
I Faretto LED
E Reflector de diodos
CN 工作灯

30W	2100 lm	6000 K	230V~50Hz
		20000 h	IP65

COB LED

COLOR BOX



YATO

YT-81803 6

GB LED lamp
D Diodenscheinwerfer
PL Reflektor diodowy
RUS Светодиодный прожектор
CZ LED reflektor
H Diódás reflektor
RO Reflector diodă
F Projecteur LED
I Faretto LED
E Reflector de diodos
CN 工作灯

50W	3500 lm	6000 K	230V~50Hz
		20000 h	IP65

COB LED

COLOR BOX



YATO

YT-81806 3

GB LED lamp with motion detector
D Diodenscheinwerfer mit Bewegungsmelder
PL Reflektor diodowy z czujnikiem ruchu
RUS Светодиодный прожектор с датчиком движения
CZ LED reflektor se snímačem pohybu
H Diódás reflektor mozgásérzékelővel
RO Reflector diodă cu senzor de mișcare
F Projecteur LED avec détecteur de mouvement
I Faretto LED con sensore movimento
E Reflector de diodos con sensor de movimiento
CN 感应灯

10W	700 lm	6000 K	230V~50Hz
		20000 h	IP44

COB LED

COLOR BOX



YATO

YT-81801 18

GB LED lamp with motion detector
D Diodenscheinwerfer mit Bewegungsmelder
PL Reflektor diodowy z czujnikiem ruchu
RUS Светодиодный прожектор с датчиком движения
CZ LED reflektor se snímačem pohybu
H Diódás reflektor mozgásérzékelővel
RO Reflector diodă cu senzor de mișcare
F Projecteur LED avec détecteur de mouvement
I Faretto LED con sensore movimento
E Reflector de diodos con sensor de movimiento
CN 感应灯

20W	1400 lm	6000 K	230V~50Hz
		20000 h	IP44

COB LED

COLOR BOX



YATO

YT-81798 16

GB LED lamp with motion detector
D Diodenscheinwerfer mit Bewegungsmelder
PL Reflektor diodowy z czujnikiem ruchu
RUS Светодиодный прожектор с датчиком движения
CZ LED reflektor se snímačem pohybu
H Diódás reflektor mozgásérzékelővel
RO Reflector diodă cu senzor de mișcare
F Projecteur LED avec détecteur de mouvement
I Faretto LED con sensore movimento
E Reflector de diodos con sensor de movimiento
CN 感应灯

30W	2100 lm	6000 K	230V~50Hz
		20000 h	IP44

COB LED

COLOR BOX



YATO

YT-81804 6

GB LED lamp with motion detector
D Diodenscheinwerfer mit Bewegungsmelder
PL Reflektor diodowy z czujnikiem ruchu
RUS Светодиодный прожектор с датчиком движения
CZ LED reflektor se snímačem pohybu
H Diódás reflektor mozgásérzékelővel
RO Reflector diodă cu senzor de mișcare
F Projecteur LED avec détecteur de mouvement
I Faretto LED con sensore movimento
E Reflector de diodos con sensor de movimiento
CN 感应灯

50W	3500 lm	6000 K	230V~50Hz
		20000 h	IP44

COB LED

COLOR BOX



YATO

YT-81807 3

- GB** Portable LED lamp
D Diodenscheinwerfer mit Tragebügel
PL Reflektor diodowy przenośny
RUS Светодиодный прожектор переносной
CZ LED reflektor přenosný
H Hordozható, diódás reflektor
RO Reflector diodă portabil
F Projecteur LED
I Faretto LED portatilea
E Reflector de diodos portátil
CN 手提式工作灯

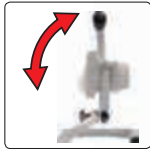

10W	700 lm
20000 h	IP65
6000 K	230V~50Hz
CABLE H05RN-F KABEL	1.8m

COB LED

COLOR BOX



YATO
YT-81802 12

- GB** Portable LED lamp
D Diodenscheinwerfer mit Tragebügel
PL Reflektor diodowy przenośny
RUS Светодиодный прожектор переносной
CZ LED reflektor přenosný
H Hordozható, diódás reflektor
RO Reflector diodă portabil
F Projecteur LED
I Faretto LED portatilea
E Reflector de diodos portátil
CN 手提式工作灯



20W	1400 lm
20000 h	IP65
6000 K	230V~50Hz
CABLE H05RN-F KABEL	1.8m

COB LED

COLOR BOX



YATO
YT-81799 8

- GB** LED lamp with tripod
D Stativ-Diodenscheinwerfer
PL Reflektor diodowy na stojaku
RUS Светодиодный прожектор на стойке
CZ LED reflektor na stojanu
H Allványos diódás reflektor
RO Reflector diodă pe stativ
F Projecteur LED sur un trépied
I Riflettore LED sul cavalletto
E Reflector de diodos con tripie
CN 灯

20W	6000 K
1400 lm	20000 h
230V~50Hz	IP65
CABLE H05RN-F KABEL	3m

COB LED

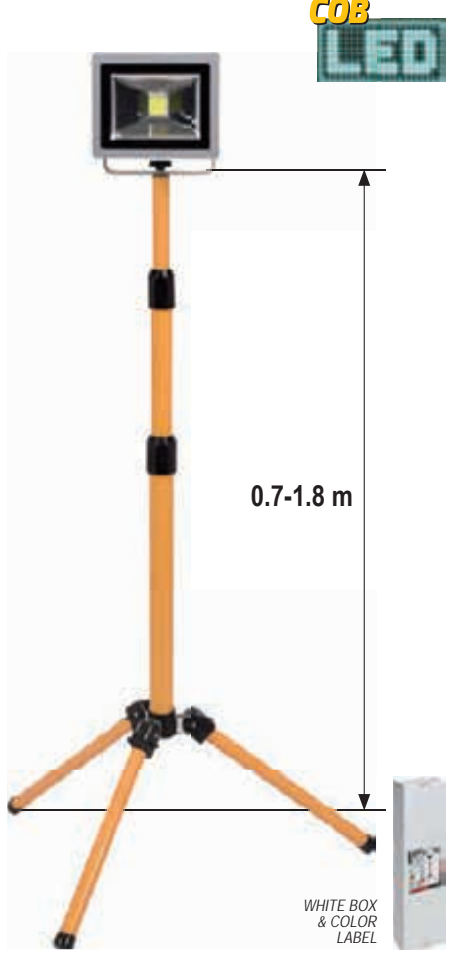

0.7-1.8 m

WHITE BOX & COLOR LABEL

YATO
YT-81788 2

- GB** LED lamp with tripod
D Stativ-Diodenscheinwerfer
PL Reflektor diodowy na stojaku
RUS Светодиодный прожектор на стойке
CZ LED reflektor na stojanu
H Allványos diódás reflektor
RO Reflector diodă pe stativ
F Projecteur LED sur un trépied
I Riflettore LED sul cavalletto
E Reflector de diodos con tripie
CN 灯

30W	6000 K
2250 lm	20000 h
230V~50Hz	IP65
CABLE H05RN-F KABEL	3m

COB LED



0.7-1.8 m

WHITE BOX & COLOR LABEL

YATO
YT-81810 2

- GB** LED lamp with tripod
D Stativ-Diodenscheinwerfer
PL Reflektor diodowy na stojaku
RUS Светодиодный прожектор на стойке
CZ LED reflektor na stojanu
H Allványos diódás reflektor
RO Reflector diodă pe stativ
F Projecteur LED sur un trépied
I Riflettore LED sul cavalletto
E Reflector de diodos con tripie
CN 灯

20W x2	6000 K
1400lm x2	20000 h
230V~50Hz	IP65
CABLE H05RN-F KABEL	3m

COB LED

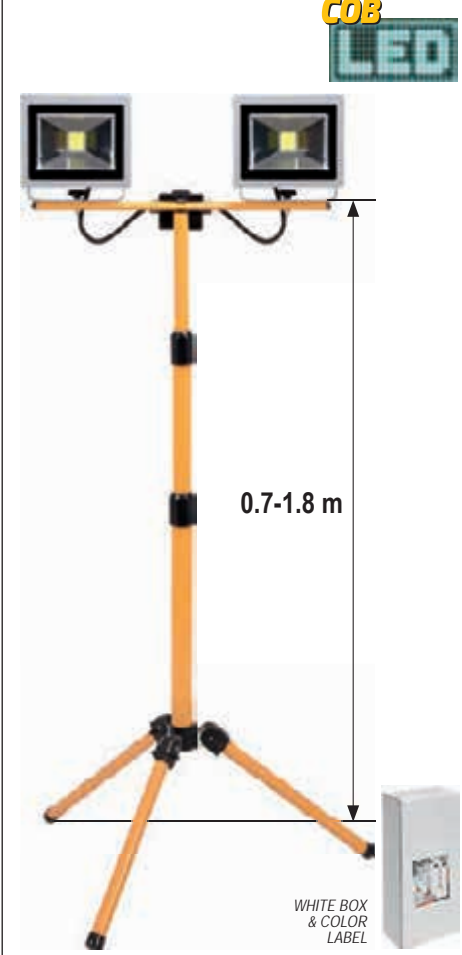

0.7-1.8 m

WHITE BOX & COLOR LABEL

YATO
YT-81789 4

GB LED rechargeable floodlight
D Akku-Diodenscheinwerfer
PL Reflektor diodowy akumulatorowy
RUS Светодиодный аккумуляторный прожектор
CZ LED reflektor dobijeci
H LED reflektor újratölthető

RO Reflector cu led dioda pe acumulatori
F Projecteur a LED rechargeable
I Lampada a LED a batteria
E LED reflector recargable
CN 工作灯

10W **3.7V** **800**
 4400mAh **lm**
Li-Ion!

6000 K **Micro** **4400mAh**
USB

CHARGING TIME **WORK TIME**
 CZAS ŁADOWANIA CZAS PRACY
5.5 h **2.5 h**

COB
LED



GB LED lamp
D Diodenscheinwerfer
PL Reflektor diodowy
RUS Светодиодный прожектор
CZ LED reflektor
H Diodás reflektor

RO Reflector diodă
F Projecteur LED
I Faretto LED
E Reflector de diodos
CN 工作灯

80W **6000** **6000 K** **230V~**
lm **50Hz**

20000 h **IP65**

COB
LED



GB Solar LED floodlight with motion detector
D Solar-Diodenscheinwerfer mit Bewegungsmelder
PL Reflektor solarny LED z czujnikiem ruchu
RUS Настенный светильник на солнечной батарее с датчиком движения
CZ LED solární reflektor se snímačem pohybu
H Napelemes reflektor led mozgásérzékelővel
RO Lampă solara cu senzor
F LED projecteur solaire avec détecteur de mouvement
I Lampada solare a LED con sensore di movimento
E LED solar reflector con sensor de movimiento
CN 带感应太阳能投光灯

SMD
LED

4W **380** **4000 K** **3.7V** **CHARGING TIME** **WORK TIME**
lm **2200mAh** **6h** **3h**
Li-Ion! **6h** **3h**



GB Solar LED wall lamp
D LED Solar-Wandleuchte
PL Lampa ścienna solarna LED
RUS Настінний світильник
CZ LED solární světla
H Fali lámpa napelemes LED
RO Lampă solara pt. perete
F Lampe solaire LED
I Lampada da parete LED solare
E Luz de pared de LED solar
CN 太阳能感应壁灯

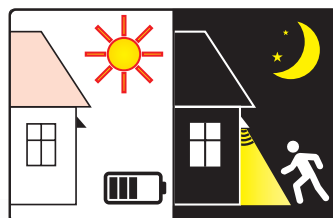

120 **3.7V**
lm **900mAh**
Li-Ion!

CHARGING TIME **WORK TIME**
 CZAS ŁADOWANIA CZAS PRACY
8 h **12 h**

3m **IP65**



- GB Solar LED floodlight with spike
- D Solar-Diodenscheinwerfer mit Spitze
- PL Reflektor solarny LED ze szpikulcem
- RUS Настенный светильник на солнечной батарее со шпиком
- CZ LED solární reflektor s hrotem
- H Napelemes reflektor LED tűskével
- RO Lampă solara cu vârf
- F LED projecteur solaire avec avec pique
- I Lampada solare a LED con punta
- E LED solar reflector con pincho
- CN 带感应太阳能地插灯

LED

4 LED 2W 3.7V 2200mAh Li-Ion 180 lm

CHARGING TIME CZAS ŁADOWANIA 6h WORK TIME CZAS PRACY 6h

IP44



YATO YT-81880 20

- GB Workshop LED battery lamp
- D LED Akku-handleuchte
- PL Diodowa lampa warsztatowa akumulatorowa
- RUS Светодиодная беспроводная лампа
- CZ Ruční svítidla LED
- H LED szerelő lámpák
- RO Lampă portabilă cu acumulator leduri
- F Lampe a LED rechargeable
- I Lampada LED per officina
- E Linterna LED recargable
- CN 可充裝款針脩



CRI 95 5W 3.7V 2600mAh Li-Ion 400 lm

4500K 4h 4h

IP65 IK07

HOOK HAK 2x

CRI 95

COLOR INSPECTION LAMP
LAMPÁ DO INSPEKCIJ LAKIERU

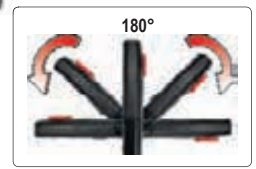
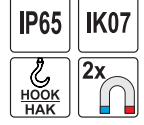

YATO YT-08509 12

- GB Workshop LED battery lamp
- D LED Akku-handleuchte
- PL Diodowa lampa warsztatowa akumulatorowa
- RUS Светодиодная беспроводная лампа
- CZ Ruční svítidla LED
- H LED szerelő lámpák
- RO Lampă portabilă cu acumulator leduri
- F Lampe a LED rechargeable
- I Lampada LED per officina
- E Linterna LED recargable
- CN 可充裝款針脩

1+1 LED 3.7V 3600mAh Li-Ion 180 lm

230V-50Hz BATTERY CHARGER ŁADOWARKA 12V

CHARGING TIME CZAS ŁADOWANIA 4h WORK TIME CZAS PRACY 3h 2 LED

HOOK HAK MAGNETIC



YATO YT-08502 10

- GB Workshop LED battery lamp
- D LED Akku-handleuchte
- PL Diodowa lampa warsztatowa akumulatorowa
- RUS Светодиодная беспроводная лампа
- CZ Ruční svítidla LED
- H LED szerelő lámpák
- RO Lampă portabilă cu acumulator leduri
- F Lampe a LED rechargeable
- I Lampada LED per officina
- E Linterna LED recargable
- CN 可充裝款針脩

5+3 W 3.7V 2600mAh Li-Ion 4h

600/260 lm 6500 K

USB BATTERY CHARGER ŁADOWARKA WORK TIME CZAS PRACY 2,5/5,5 h

MAGNETIC POLYCARBONATE DIFFUSER KŁOSZ Z POLIWĘGLANU

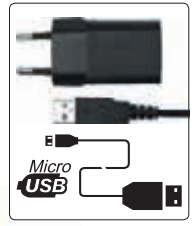
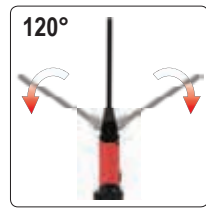

YATO YT-08518 12

GB Workshop LED battery lamp
 D LED Akku-handleuchte
 PL Diodowa lampa warsztatowa akumulatorowa
 RUS Светодиодная беспроводная лампа
 CZ Ruční svítidla LED
 H LED szerelő lámpák
 RO Lampa portabila cu acumulator leduri
 F Lampe a LED rechargeable
 I Lampada LED per officina
 E Linterna LED recargable
 CN 可充式LED灯



3W
 3.7V
 2200mAh
 Li-Ion
 250
 lm
 6000 K
 230V~
 50Hz
 BATTERY
 CHARGER
 LADOWARKA
 5 h
 WORK TIME
 CZAS PRACY
 3.5 h
 IP54
 IK07
 POLYCARBONATE
 DIFFUSER
 KLÓZ
 Z POLIWĘGLANU
 MAGNETIC

COB
 LED



YATO
 YT-08563 10

GB Workshop LED battery lamp
 D LED Akku-handleuchte
 PL Diodowa lampa warsztatowa akumulatorowa
 RUS Светодиодная беспроводная лампа
 CZ Ruční svítidla LED
 H LED szerelő lámpák
 RO Lampa portabila cu acumulator leduri
 F Lampe a LED rechargeable
 I Lampada LED per officina
 E Linterna LED recargable
 CN 可充式LED灯



FRONT LIGHTING
 FUNKCJA LATARNI
 3.5+3
 W
 3.7V
 2200mAh
 Li-Ion
 280
 lm
 6000 K
 USB
 BATTERY
 CHARGER
 LADOWARKA
 4h
 WORK TIME
 CZAS PRACY
 3.5 h
 IP54
 IK07
 POLYCARBONATE
 DIFFUSER
 KLÓZ
 Z POLIWĘGLANU
 x2
 HOOK
 HAK
 x3

SMD
 LED

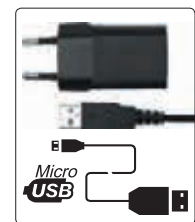

YATO
 YT-08508 12

GB Workshop LED battery lamp
 D LED Akku-handleuchte
 PL Diodowa lampa warsztatowa akumulatorowa
 RUS Светодиодная беспроводная лампа
 CZ Ruční svítidla LED
 H LED szerelő lámpák
 RO Lampa portabila cu acumulator leduri
 F Lampe a LED rechargeable
 I Lampada LED per officina
 E Linterna LED recargable
 CN 可充式LED灯

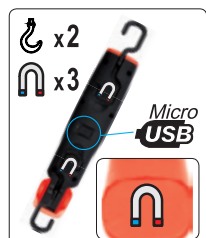

FRONT LIGHTING
 FUNKCJA LATARNI
 30+7
 LED
 140
 lm
 3.7V
 2000mAh
 Li-Ion
 USB
 BATTERY
 CHARGER
 LADOWARKA
 4h
 WORK TIME
 CZAS PRACY
 4h
 CHARGING TIME
 CZAS ŁADOWANIA
 4h
 POLYCARBONATE
 DIFFUSER
 KLÓZ
 Z POLIWĘGLANU
 x3
 x2
 HOOK
 HAK

LED

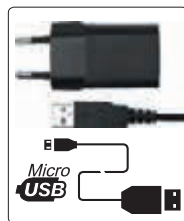

YATO
 YT-08507 12

GB Workshop LED battery lamp
 D LED Akku-handleuchte
 PL Diodowa lampa warsztatowa akumulatorowa
 RUS Светодиодная беспроводная лампа
 CZ Ruční svítidla LED
 H LED szerelő lámpák
 RO Lampa portabila cu acumulator leduri
 F Lampe a LED rechargeable
 I Lampada LED per officina
 E Linterna LED recargable
 CN 可充式LED灯





FRONT LIGHTING
 FUNKCJA LATARNI
 1+7
 LED
 250
 lm
 3.7V
 1800mAh
 Li-Ion
 12V
 BATTERY
 CHARGER
 LADOWARKA
 USB
 BATTERY
 CHARGER
 LADOWARKA
 4h
 WORK TIME
 CZAS PRACY
 4h
 CHARGING TIME
 CZAS ŁADOWANIA
 4h
 POLYCARBONATE
 DIFFUSER
 KLÓZ
 Z POLIWĘGLANU
 x2
 HOOK
 HAK
 x2

COB
 LED



YATO
 YT-08504 10

- GB Workshop LED battery lamp
D LED Akku-handleuchte
PL Diodowa lampa warsztatowa akumulatorowa
RUS Светодиодная беспроводная лампа
CZ Ruční svítidla LED
H LED szerelő lámpák
RO Lampă portabilă cu acumulator leduri
F Lampe a LED rechargeable
I Lampada LED per officina
E Linterna LED recargable
CN 可充養駁釘腑

30+7 LED	85 lm	3.7V 1800mAh Li-Ion	12V BATTERY CHARGER LADOWARKA
	230V~50Hz BATTERY CHARGER LADOWARKA	CHARGING TIME CZAS ŁADOWANIA 4-5 h	
WORK TIME CZAS PRACY 15h 7LED	WORK TIME CZAS PRACY 4h 30LED		

LED





COLOR
BOX



YATO
YT-08505 10



- GB LED workshop lamp
D LED Werkstattlampe
PL Diodowa lampa warsztatowa
RUS Светодиодная беспроводная лампа
CZ Montážní lampa
H LED lámpa
RO Lampă cu LED
F Lampe d'atelier a LED
I Lampada LED per autofficina
E Lámpara de taller LED
CN 可充養駁釘腑

27 LED	13000 MCD	3.6V 1200mAh Ni-MH	
12V BATTERY CHARGER LADOWARKA	230V~50Hz BATTERY CHARGER LADOWARKA	WATER PROOF ODPORNA NA WODĘ	CHARGING TIME CZAS ŁADOWANIA 4h
WORK TIME CZAS PRACY 4h	WORK TIME CZAS PRACY 4h		

LED



DOUBLE
BLISTER



YATO
YT-08523 10



- GB LED workshop lamp
D LED Werkstattlampe
PL Diodowa lampa warsztatowa
RUS Светодиодная беспроводная лампа
CZ Montážní lampa
H LED szerelő lámpák
RO Lampă cu LED
F Lampe d'atelier a LED
I Lampada LED per autofficina
E Lámpara de taller LED
CN 可充養駁釘腑

60+1 LED	13000 MCD	7.2V 800mAh Ni-MH	230V~50Hz BATTERY CHARGER LADOWARKA
WORK TIME CZAS PRACY 4h	CHARGING TIME CZAS ŁADOWANIA 4h	WATER PROOF ODPORNA NA WODĘ	
12V BATTERY CHARGER LADOWARKA			

LED

DOUBLE
BLISTER





YATO
YT-0852 5/20



- GB LED workshop lamp
D LED Werkstattlampe
PL Diodowa lampa warsztatowa
RUS Светодиодная беспроводная лампа
CZ Montážní lampa
H LED szerelő lámpák
RO Lampă cu LED
F Lampe d'atelier a LED
I Lampada LED per autofficina
E Lámpara de taller LED
CN 可充養駁釘腑



8+1 LED	280 lm	3 LIGHTING OPTIONS OPCJE ŚWIĘCENIA	
WORK TIME CZAS PRACY 4 h 9 LED	1.5V 3x AA		

SMD
LED



COLOR
BOX



YATO
YT-08513 50



GB LED workshop lamp
D LED Werkstattlampe
PL Diodowa lampa warsztatowa
RUS Светодиодный светильник для мастерской
CZ Montážní lampa
H LED szerelő lámpák
RO Lampa cu LED
F Lampe d'atelier a LED
I Lampada LED per autofficina
E Lámpara de taller LED
CN 可充長款釘腳



8 LED **80 lm** **1.5V 3x AAA** **WORK TIME CZAS PRACY 20 h 8 LED**

SMD LED



YATO **YT-08514** **12/72**

GB LED workshop lamp
D LED Werkstattlampe
PL Diodowa lampa warsztatowa
RUS Светодиодный светильник для мастерской
CZ Montážní lampa
H LED szerelő lámpák
RO Lampa cu LED
F Lampe d'atelier a LED
I Lampada LED per autofficina
E Lámpara de taller LED
CN 可充長款釘腳



4 LED **400 lm** **IP65** **CABLE HO5RN-F KABEL**
230V~50Hz **HOOK HAK** **4.9m**

POWER LED



YATO **YT-08531** **10**

GB Workshop LED battery lamp
D LED Akku-handleuchte
PL Diodowa lampa warsztatowa akumulatorowa
RUS Светодиодная лампа LED

CZ Ruční svítidla LED
H LED szerelő lámpák
RO Lampa portabila cu acumulator leduri
F Lampe a LED rechargeable

I Lampada LED trasportabile per illuminazione di vani motore
E Linterna LED recargable
CN 引擎盖检修灯

SMD LED

100 LED **600 lm** **7.4V 2000mAh Li-Ion** **230V~50Hz BATTERY CHARGER LADONWARKA**
CHARGING TIME CZAS ŁADOWANIA 3-4 h **WORK TIME CZAS PRACY 4 h 100 LED** **HOOK HAK** **MAGNETIC**



YATO **YT-08503** **8**

GB Workshop LED battery lamp
D LED Akku-handleuchte
PL Diodowa lampa warsztatowa akumulatorowa
RUS Светодиодная лампа LED

CZ Ruční svítidla LED
H LED szerelő lámpák
RO Lampa portabila cu acumulator leduri
F Lampe a LED rechargeable

I Lampada LED trasportabile per illuminazione di vani motore
E Linterna LED recargable
CN 引擎盖检修灯

LED

350 lm **60 LED** **120 LED** **7.2V 1800mAh Ni-MH** **230V~50Hz BATTERY CHARGER LADONWARKA**
120 LED **WORK TIME CZAS PRACY 8 h 60 LED** **WORK TIME CZAS PRACY 4h 120LED** **CHARGING TIME CZAS ŁADOWANIA 4-5 h** **HOOK HAK** **MAGNETIC**

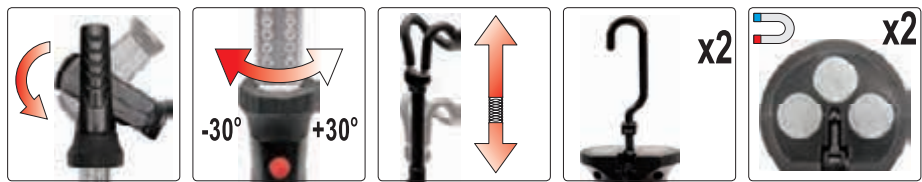

YATO **YT-08530** **4**

GB Workshop LED battery lamp
D LED Akku-handleuchte
PL Diodowa lampa warsztatowa akumulatorowa
RUS Светодиодная лампа LED

CZ Ruční svítidla LED
H LED szerelő lámpák
RO Lampa portabila cu acumulator leduri
F Lampe a LED rechargeable

I Lampada LED trasportabile per illuminazione di vani motore
E Linterna LED recargable
CN 引擎盖检修灯

SMD LED

36 LED **18 LED** **36 LED** **7.4V 2400mAh Li-Ion** **230V~50Hz BATTERY CHARGER LADONWARKA**
900 lm **CHARGING TIME CZAS ŁADOWANIA 5.5 h** **WORK TIME CZAS PRACY 3.5 h** **HOOK HAK** **MAGNETIC**

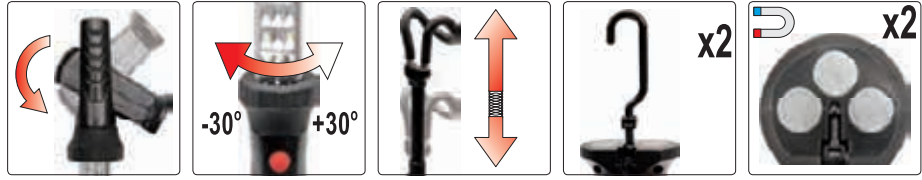

YATO **YT-08533** **4**

GB Workshop LED battery lamp
D LED Akku-handleuchte
PL Diodowa lampa warsztatowa akumulatorowa
RUS Светодиодная лампа LED

CZ Ruční svítidla LED
H LED szerező lámpák
RO Lampa portabila cu acumulator leduri
F Lampe a LED rechargeable

I Lampada LED trasportabile per illuminazione di vani motore
E Linterna LED rechargeable
CN 引擎盖检修灯

SMD

LED

12W	1200 lm	4000 K	230V~50Hz	CABLE H05RN-F KABEL
5m	2x 1.0mm ²	POLYCARBONATE DIFFUSER KÖZELÉK Z POLYMERGLANU	HOOK HAK	IP54



GB UV LED flashlight and glasses set
D UV LED-Taschenlampe mit UV Schutzbrille
PL Zestaw latarka UV LED i okulary
RUS Комплект для проверки утечек хладогента - UV фонарь LED

UV

LED

51 LED	UV
395 nm	1.5V 3x AA



CZ UV LED svítilna + brýle
H UV LED zseblámpa + szemüveg
RO Set lanternă UV LED și ochelari
F UV LED lampe de poche avec lunettes
I Set torcia UV LED e occhiali
E UV LED linterna con gafas para
CN 手电筒



GB LED Flashlight
D LED Taschenlampe
PL Latarka LED
RUS Светодиодный фонарь
CZ LED svítilna
H LED zseblámpa
RO Lanternă cu LED
F LED lampe de torche

6W	XPG3	500 lm	230 m
4 LIGHTING MODES TRYBY SWIĘCENIA	IPX7	6V 4x AA	

POWER

LED



GB LED Flashlight
D LED Taschenlampe
PL Latarka LED
RUS Светодиодный фонарь
CZ LED svítilna
H LED zseblámpa

RO Lanternă cu LED
F LED lampe de torche
I Torcia LED
E Linterna LED
CN 手电筒

10W	XPL	1000 lm	350 m
3 LIGHTING MODES TRYBY SWIĘCENIA	ZOOM	IPX4	6V 4x AA

POWER

LED



GB LED Flashlight
D LED Taschenlampe
PL Latarka LED
RUS Светодиодный фонарь
CZ LED svítilna
H LED zseblámpa
RO Lanternă cu LED
F LED lampe de torche

I Torcia LED
E Linterna LED
CN 手电筒

3W	XPE2	200 lm	120 m
2 LIGHTING MODES TRYBY SWIĘCENIA	IPX4	3V 2x AA	

POWER

LED



GB LED Flashlight
D LED Taschenlampe
PL Latarka LED
RUS Светодиодный фонарь
CZ LED svítilna
H LED zseblámpa
RO Lanternă cu LED
F LED lampe de torche

I Torcia LED
E Linterna LED
CN 手电筒

5W	XPG2	300 lm	150 m
3 LIGHTING MODES TRYBY SWIĘCENIA	IPX4	4.5V 3x AAA	

POWER

LED



GB LED Flashlight
D LED Taschenlampe
PL Latarka LED
RUS Светодиодный фонарь
CZ LED svítilna
H LED zseblámpa
RO Lanternă cu LED
F LED lampe de torche

I Torcia LED
E Linterna LED
CN 手电筒

6W	XPG3	500 lm	
200 m	3 LIGHTING MODES TRYBY SWIĘCENIA	ZOOM	

3.7V 2200mAh Li-Ion	IPX7	USB BATTERY CHARGER ŁADOWNIK	
---------------------	------	------------------------------	--

POWER

LED



- GB LED Flashlight
 D LED Taschenlampe
 PL Latarka LED
 RUS Светодиодный фонарь
 CZ LED svítilna
 H LED zseblámpa
 RO Lanterna cu LED
- F LED lampe de torche
 I Torcia LED
 E Linterna LED
 CN 手电筒

5W **XTE** **350 Im**

150 m **4 LIGHTING MODES TRYBY SVIŠCENIA** **3x ZOOM**

3.7 V 650 mAh Li-Ion **USB BATTERY CHARGER LADOVARKA** **IPX4**



DOUBLE BLISTER



YATO	W	Im	
YT-08569	5	350	12/96

- GB LED Flashlight
 D LED Taschenlampe
 PL Latarka LED
 RUS Светодиодный фонарь
 CZ LED svítilna
 H LED zseblámpa

- RO Lanterna cu LED
 F LED lampe de torche
 I Torcia LED
 E Linterna LED
 CN 手电筒

3W **130 Im** **3x ZOOM**

IP64 **1.5V 2x C** **WATER PROOF ODPORNÁ NA WODE**



SLIDING CARD



YATO	W	Im	
YT-08577	3	130	12/48

- GB LED Flashlight
 D LED Taschenlampe
 PL Latarka LED
 RUS Светодиодный фонарь
 CZ LED svítilna
 H LED zseblámpa

- RO Lanterna cu LED
 F LED lampe de torche
 I Torcia LED
 E Linterna LED
 CN 手电筒

3W **100 Im** **3x ZOOM**

IP64 **1.5V 2x AA** **WATER PROOF ODPORNÁ NA WODE**



SLIDING CARD



YATO	W	Im	
YT-08575	3	100	12/72

- GB LED Flashlight
 D LED Taschenlampe
 PL Latarka LED
 RUS Светодиодный фонарь
 CZ LED svítilna
 H LED zseblámpa

- RO Lanterna cu LED
 F LED lampe de torche
 I Torcia LED
 E Linterna LED
 CN 手电筒

3W **110 Im** **3x ZOOM**

IP64 **1.5V 2x AA** **WATER PROOF ODPORNÁ NA WODE**



SLIDING CARD



YATO	W	Im	
YT-08572	3	110	12/72

- GB LED Flashlight
 D LED Taschenlampe
 PL Latarka LED
 RUS Светодиодный фонарь
 CZ LED svítilna
 H LED zseblámpa
 RO Lanterna cu LED
 F LED lampe de torche

- I Torcia LED
 E Linterna LED
 CN 手电筒

3W **100 Im** **3x ZOOM** **IP64**

1.5V AA **WATER PROOF ODPORNÁ NA WODE**



SLIDING CARD



YATO	W	Im	
YT-08571	3	100	24/96

- GB LED Flashlight
 D LED Taschenlampe
 PL Latarka LED
 RUS Светодиодный фонарь
 CZ LED svítilna
 H LED zseblámpa
 RO Lanterna cu LED
 F LED lampe de torche
 I Torcia LED
 E Linterna LED
 CN 手电筒

9 LED **1.5V 3x AAA**



SLIDING CARD



YATO	W	Im	
YT-08570			24/192

- GB LED head lamp
 D LED kopflampe
 PL Diodowa lampka czolowa
 RUS Налобный светодиодный фонарь
 CZ LED montážní lampka - čelovka
 H LED fejlámpa
 RO Lampa cu LED
 F Lampe frontale LED
 I Lampada da testa
 E Linterna de diodo
 CN LED头灯

10W **XM-L2** **450 Im** **3x ZOOM**

3 LIGHTING MODES TRYBY SVIŠCENIA **6V 4x AA**



DOUBLE BLISTER



YATO	W	Im	
YT-08591	10	450	6/24

- GB LED head lamp
 D LED kopflampe
 PL Diodowa lampka czolowa
 RUS Налобный светодиодный фонарь
 CZ LED montážní lampka - čelovka
 H LED fejlámpa
 RO Lampa cu LED
 F Lampe frontale LED
 I Lampada da testa
 E Linterna de diodo
 CN LED头灯

3W **100 Im** **3x ZOOM** **WATER PROOF ODPORNÁ NA WODE** **1.5V 3x AAA**



SLIDING CARD





YATO	W	Im	
YT-08590	3	100	25/100

- GB** Rubber protection extension cord
D Gummiisolierte Verlängerungsschnur
PL Przedłużacz w osłonie gumowej
RUS Удлинитель с резиновой изоляцией
CZ Prodlužovací kabel s gumovou izolací
H Gumi szigetelésű hosszabbító
RO Cablu prelungitor cauciuc
F Rallonge électrique
I Prolunga in gomma
E Cable de extensión con protección de caucho
CN 电缆延长线



CABLE
H05RR-F
KABEL
3G1.5
mm²
CABLE / KABEL

YATO	L (m)	
YT-81021	10	8
YT-81022	20	4
YT-81023	30	4
YT-81024	40	2

IP44 **16A**   **230V~50Hz**



CABLE
H05RR-F
KABEL
3G2.5
mm²
CABLE / KABEL

YATO	L (m)	
YT-8100	20	4
YT-8101	30	2
YT-8102	40	2

COLOR
BOX



CABLE
H07RN-F
KABEL
3G1.5
mm²
CABLE / KABEL

YATO	L (m)	
YT-8111	5	16
YT-8112	10	8





CABLE
H07RN-F
KABEL
3G1.5
mm²
CABLE / KABEL

YATO	L (m)	
YT-8116	10	4
YT-81162	20	4

- GB** Cable reel
D Kabeltrommel
PL Przedłużacz zwijany
RUS Удлинитель электрический
CZ Bubnový prodlužovač
H Kábeldob
RO Prelungitor pe tambur
F Rallonge électrique sur tambour enrouleur
I Avvolgicavo con bobina
E Cable de prolongación de tambor
CN 电缆延长线

IP44 **16A**

CABLE
H05RR-F
KABEL
3G1.5
mm²
CABLE / KABEL



 

230V~50Hz

- GB** Cable reel
D Kabeltrommel
PL Przedłużacz zwijany
RUS Удлинитель электрический
CZ Bubnový prodlužovač
H Kábeldob
RO Prelungitor pe tambur
F Rallonge électrique sur tambour enrouleur
I Avvolgicavo con bobina
E Cable de prolongación de tambor
CN 电缆延长线

IP44 **16A**

CABLE
H05RR-F
KABEL
3G2.5
mm²
CABLE / KABEL



 

PLASTIC REEL
BEBEN
PLASTIKOWY **230V~50Hz**

- GB** Drum power extension cord
D Verlängerungstrommel für Kraftstrom
PL Przedłużacz bębnowy silowy
RUS Силовой удлинитель барабанного типа
CZ Prodlužovací kabel silový na bubnu
H Háromfázisú hosszabbító dob
RO Derulator cu tambur
F Rallonge électrique sur tambour enrouleur
I Avvolgicavo di forza
E Cilindro de extensión de fuerza
CN 电缆延长线

IP44 **~400V~230V**

CABLE
H07RN-F
KABEL
5G2.5
mm²
CABLE / KABEL



- $P_{max} = 1000$ W coiled
- $P_{max} = 1000$ W zwinięty
- $P_{max} = 3000$ W uncoiled
- $P_{max} = 3000$ W rozwinęty

POLYBAG



YATO	L (m)	
YT-81052	20	2
YT-81053	30	2
YT-81054	40	2



- $P_{max} = 1200$ W coiled
- $P_{max} = 1200$ W zwinięty
- $P_{max} = 3600$ W uncoiled
- $P_{max} = 3600$ W rozwinęty

POLYBAG



YATO	L (m)	
YT-8106	30	1
YT-8107	40	1
YT-8108	50	1



- ~230V; 2P+E
- $P_{max} = 1200$ W coiled
- $P_{max} = 1200$ W zwinięty
- $P_{max} = 3000$ W uncoiled
- $P_{max} = 3000$ W rozwinęty
- ~400V; 3P+N+E
- $P_{max} = 3000$ W coiled
- $P_{max} = 3000$ W zwinięty
- $P_{max} = 9000$ W uncoiled
- $P_{max} = 9000$ W rozwinęty

POLYBAG



YATO	L (m)	
YT-8120	25	1

22

Garden tools Narzędzia ogrodnicze



Watering program
Program wodny

454-461



Cordless garden tools & accessories

Ogrodowe narzędzia akumulatorowe i akcesoria

470-473



Hose connectors, male connectors, couplings, hose menders

Złącza, nypły, łączniki, rozgałęźniacze, reparatory..... 454

Hose nozzles (sprinklers) & sets

Zraszacze i zestawy..... 456

Garden hose holders

Stojaki na węże ogrodowe..... 461

Pumps

Pompy..... 461

Cordless chainsaws

Akumulatorowe pilarki łańcuchowe..... 470

Cordless grass trimmers

Akumulatorowe wykasarki..... 470

Cordless hedge trimmers

Akumulatorowe nożyce do żywopłotu..... 472

Pruners & shears

Sekatory i nożyce ogrodowe

462-466



Electric garden tools

Ogrodowe narzędzia elektryczne

473



Electric chainsaws

Elektryczne pilarki łańcuchowe..... 473

Pruners

Sekatory..... 462

Lopping shears

Sekatory do gałęzi..... 464

Leverage tree pruners

Sekatory gąsienicowe..... 465

Hedge shears

Nożyce do żywopłotu..... 466

Grass shears

Nożyce do trawy..... 466

Gasoline garden tools & accessories

Ogrodowe narzędzia spalinowe i akcesoria

473-479



Gasoline sprayers

Opryskiwacze spalinowe..... 473

Gasoline chainsaws

Pilarki spalinowe..... 474

Gasoline brushcutters

Kosy spalinowe..... 475

Gasoline hedge trimmers

Spalinowe nożyce do żywopłotu..... 475

Accessories

Akcesoria..... 475

Bow saws & blades

Piły kabłąkowe i brzeszczoły

467



Axes

Siekiery

467



Hand tools

Narzędzia ręczne

468-469



Small garden tools

Małe narzędzia ogrodowe..... 468

Big garden tools

Duże narzędzia ogrodowe..... 469

- GB** Hose connector
D Universal
 Schnellschlauchkupplung
PL Złącze standard
RUS Соединитель
CZ Rychlospojka
H Fitting
RO Mufă pt. pistol
F Raccord standard
I Connettore standard
E Junta estandar
CN 通水接头



- GB** Waterstop hose connector
D Universal
 Schnellschlauchkupplung mit Wasserstop
PL Złącze stop
RUS Соединитель с автостопом
CZ Rychlospojka
H Fitting
RO Mufă pt. pistol
F Raccord stop
I Connettore stop
E Junta estandar
CN 止水接头



- GB** Hose connector
D Universal
 Schnellschlauchkupplung
PL Złącze standard
RUS Соединитель
CZ Rychlospojka
H Fitting
RO Mufă pt. pistol
F Raccord standard
I Connettore standard
E Junta estandar
CN 通水接头



- GB** Waterstop hose connector
D Universal
 Schnellschlauchkupplung mit Wasserstop
PL Złącze stop
RUS Соединитель с автостопом
CZ Rychlospojka
H Fitting
RO Mufă pt. pistol
F Raccord stop
I Connettore stop
E Junta estandar
CN 止水接头



TIED ON CARD



TIED ON CARD



TIED ON CARD



TIED ON CARD

YATO	size / rozmiar	
YT-99801	1/2" 12.5 mm	12/120

YATO	size / rozmiar	
YT-99803	1/2" 12.5 mm	12/120

YATO	size / rozmiar	
YT-99802	3/4" 19.0 mm	12/120

YATO	size / rozmiar	
YT-99804	3/4" 19.0 mm	12/120

- GB** Hose mender
D Schlauchreparator,
 Schlauchverbinder
PL Reparatör do węzła
RUS Соединитель шлангов
CZ Opravka
H Gyorstoldó
RO Mufă înădire
F Réparateur de tuyau
I Tubo reparatore
E Reparador para manguera
CN 修补接头



- GB** Hose mender
D Schlauchreparator,
 Schlauchverbinder
PL Reparatör do węzła
RUS Соединитель шлангов
CZ Opravka
H Gyorstoldó
RO Mufă înădire
F Réparateur de tuyau
I Tubo reparatore
E Reparador para manguera
CN 修补接头



- GB** Hose mender
D Schlauchreparator,
 Schlauchverbinder
PL Reparatör do węzła
RUS Соединитель шлангов
CZ Opravka
H Gyorstoldó
RO Mufă înădire
F Réparateur de tuyau
I Tubo reparatore
E Reparador para manguera
CN 修补接头



- GB** Snap-in tap adaptor
D Wasserhahnanschluss
 für Gartenschlauch
PL Przyłącze do kranu
RUS Адаптер внутренний
CZ Sroubení
H Tömlovég csaphoz
RO Mufă pt. robinet
 cu filet interior
F Raccord
I Collegamento al rubinetto
E Tubuladura de grifo
CN 铁箍接头



TIED ON CARD



TIED ON CARD



TIED ON CARD



TIED ON CARD

YATO	size / rozmiar	
YT-99810	1/2" 12.5 mm	12/120

YATO	size / rozmiar	
YT-99811	3/4" 19.0 mm	12/120

YATO	size / rozmiar	
YT-8979	1/2"; 3/4" 12.5; 19.0 mm	24/240

YATO	size / rozmiar	
YT-8970	1/2" 12.5 mm	24/240

- GB** Snap-in tap adaptor
D Wasserhahnanschluss
 für Gartenschlauch
PL Przyłącze do kranu
RUS Адаптер внутренний
CZ Sroubení
H Tömlovég csaphoz
RO Mufă pt. robinet
 cu filet interior
F Raccord
I Collegamento al rubinetto
E Tubuladura de grifo
CN 铁箍接头



- GB** Snap-in tap adaptor
D Wasserhahnanschluss
 für Gartenschlauch
PL Przyłącze do kranu
RUS Адаптер внутренний
CZ Sroubení
H Tömlovég csaphoz
RO Mufă pt. robinet
 cu filet interior
F Raccord
I Collegamento al rubinetto
E Tubuladura de grifo
CN 铁箍接头



- GB** Snap-in tap adaptor
D Wasserhahnanschluss
 für Gartenschlauch
PL Przyłącze do kranu
RUS Адаптер внутренний
CZ Sroubení
H Tömlovég csaphoz
RO Mufă pt. robinet
 cu filet interior
F Raccord
I Collegamento al rubinetto
E Tubuladura de grifo
CN 铁箍接头



- GB** Snap-in tap adaptor
D Wasserhahnanschluss
 für Gartenschlauch
PL Przyłącze do kranu
RUS Адаптер внутренний
CZ Sroubení
H Tömlovég csaphoz
RO Mufă pt. robinet
 cu filet interior
F Raccord
I Collegamento al rubinetto
E Tubuladura de grifo
CN 铁箍接头



TIED ON CARD



TIED ON CARD



TIED ON CARD



TIED ON CARD

YATO	size / rozmiar	
YT-8971	3/4" 19.0 mm	12/120

YATO	size / rozmiar	
YT-99812	3/4" 19.0 mm	12/120

YATO	size / rozmiar	
YT-8972	1" 25.0 mm	12/120

YATO	size / rozmiar	
YT-99813	1" 25.0 mm	12/120

GB Snap-in tap adaptor
D Wasserhahnanschluss für Gartenschlauch
PL Przyłącze do kranu
RUS Адаптер внутренний
CZ Šroubení
H Tömlovég csaphoz
RO Mufă pt. robinet cu filet interior
F Raccord
I Collegamento al rubinetto
E Tubuladura de grifo
CN 铁箍接头

1/2"
12.5mm

3/4"
19mm

ABS



TIED ON CARD

YATO	size / rozmiar	
YT-8973	1/2"; 3/4" 12.5; 19.0 mm	12/120

GB Snap-in tap adaptor
D Wasserhahnanschluss für Gartenschlauch
PL Przyłącze do kranu
RUS Адаптер внутренний
CZ Šroubení
H Tömlovég csaphoz
RO Mufă pt. robinet cu filet interior
F Raccord
I Collegamento al rubinetto
E Tubuladura de grifo
CN 铁箍接头

1/2"
12.5mm

3/4"
19mm

ABS



TIED ON CARD

YATO	size / rozmiar	
YT-99814	1/2"; 3/4" 12.5; 19.0 mm	12/120

GB Snap-in tap adaptor
D Wasserhahnanschluss für Gartenschlauch
PL Przyłącze do kranu
RUS Адаптер внутренний
CZ Šroubení
H Tömlovég csaphoz
RO Mufă pt. robinet cu filet interior
F Raccord
I Collegamento al rubinetto
E Tubuladura de grifo
CN 铁箍接头

3/4"
19mm

1"
25mm

ABS



TIED ON CARD

YATO	size / rozmiar	
YT-8974	3/4"; 1" 19.0; 25.0 mm	12/120

GB Snap-in tap adaptor
D Wasserhahnanschluss für Gartenschlauch
PL Przyłącze do kranu
RUS Адаптер внутренний
CZ Šroubení
H Tömlovég csaphoz
RO Mufă pt. robinet cu filet interior
F Raccord
I Collegamento al rubinetto
E Tubuladura de grifo
CN 铁箍接头

3/4"
19mm

1"
25mm

ABS



TIED ON CARD

YATO	size / rozmiar	
YT-99815	3/4"; 1" 19.0; 25.0 mm	12/120

GB Snap-in tap adaptor
D Wasserhahnanschluss für Gartenschlauch
PL Przyłącze do kranu
RUS Адаптер внутренний
CZ Šroubení
H Tömlovég csaphoz
RO Mufă pt. robinet cu filet interior
F Raccord
I Collegamento al rubinetto
E Tubuladura de grifo
CN 铁箍接头

3/4"
19mm

ABS



TIED ON CARD

YATO	size / rozmiar	
YT-8975	3/4" 19.0 mm	24/240

GB 2 way coupling
D Schlauchkupplung
PL Złącze typu „I”
RUS Соединитель шлангов
CZ Spojka
H „I” típusú csötöldő idom
RO Prelungitor furtun apă
F Connecteur type „I”
I Connettore tipo „I”
E Junta tipo „I”
CN 双向水管接头

ABS



TIED ON CARD

YATO		
YT-8976		24/240

GB 3 way coupling
D Drei wege kupplung
PL Rozdzielacz typu „Y”
RUS Тройник для шлангов
CZ Y-kus
H „Y” típusú elágazás
RO Distributor 3 căi
F Dérivation type „Y”
I Connettore tipo „Y”
E Distribuidor tipo „Y”
CN 三向水管接头

ABS



TIED ON CARD

YATO		
YT-8977		24/240

GB Y-switch coupling with swivel
D 2-Wege Ventil
PL Rozdzielacz z zaworami
RUS Распределитель внешний
CZ Rozbočovač s uzavíracími ventily
H Y-elágazó, 2 db külső menetes elzáróval
RO Racord iny cu robinet
F Dérivation type „Y”
I Distributore con valvole
E Distribuidor tipo „Y”
CN 双通水管转换接头

1/2"
12.5mm

ABS



TIED ON CARD

YATO	size / rozmiar	
YT-8978	1/2" 12.5 mm	24/240

GB One way tap adaptor
D Garten-Ventil
PL Zawór ogrodowy
RUS Вентиль
CZ Ventil
H Szelep
RO Robinet
F Raccord régulateur
I Valvola giardino
E Válvula
CN 接头

3/4"
19mm

BRASS
MOSIADZ

AI

ABS



TIED ON CARD

YATO	size / rozmiar	
YT-9940	3/4" 19.0 mm	12/48

GB Y-switch coupling with swivel
D 2-Wege Ventil
PL Rozdzielacz z zaworami
RUS Распределитель внешний
CZ Rozbočovač s uzavíracími ventily
H Y-elágazó, 2 db külső menetes elzáróval
RO Racord iny cu robinet
F Soupape double
I Distributore con valvole
E Distribuidor tipo „Y”
CN 两用转换接头

3/4"
19mm

1"
25mm

ABS



TIED ON CARD

YATO	size / rozmiar	
YT-99848	3/4"; 1" 19.0; 25.0 mm	12/48

GB Y-switch coupling with swivel
D 2-Wege Ventil
PL Rozdzielacz z zaworami
RUS Распределитель внешний
CZ Rozbočovač s uzavíracími ventily
H Y-elágazó, 2 db külső menetes elzáróval
RO Racord iny cu robinet
F Raccord régulateur double
I Distributore con valvole
E Distribuidor tipo „Y”
CN 两用转换接头

3/4"
19mm

BRASS
MOSIADZ

AI

ABS



TIED ON CARD

YATO	size / rozmiar	
YT-9941	3/4" 19.0 mm	12/48

GB Adjustable spray nozzle
D Spritze
PL Zraszacz prosty regulowany
RUS Распылитель поливочный
CZ Postřikovač
H Szórófej
RO Stropitor apă

F Pistolet d'arrosage droit et réglé
I Semplice sprinkler regolabile
E Rociador
CN 铝合金调节式水枪

Zn ABS



TIED ON CARD

YATO **YT-8950** 12/48

GB Adjustable spray nozzle
D Spritze
PL Zraszacz prosty regulowany
RUS Распылитель поливочный
CZ Postřikovač
H Szórófej
RO Stropitor apă

F Pistolet d'arrosage droit et réglé
I Semplice sprinkler regolabile
E Rociador
CN 铝合金调节式水枪

ABS



TIED ON CARD

YATO **YT-99830** 12/120

GB Adjustable spray gun
D Regelbare Sprühpistole
PL Pistolet zraszający regulowany
RUS Регулируемый оросительный пистолет
CZ Kropící pistole regulovatelná

H Öntöző pisztoly, állítható sugarú
RO Pistolet de irigare ajustabil
F Pistolet d'arrosage réglé
I Pistola a spruzzo regolabile
E Pistola rociadora ajustable
CN 调节式水枪

AI ABS

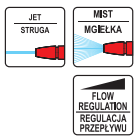

TIED ON CARD



YATO **YT-8965** 12/48

GB Adjustable spray gun
D Regelbare Sprühpistole
PL Pistolet zraszający regulowany
RUS Регулируемый оросительный пистолет
CZ Kropící pistole regulovatelná

H Öntöző pisztoly, állítható sugarú
RO Pistolet de irigare ajustabil
F Pistolet d'arrosage réglé
I Pistola a spruzzo regolabile
E Pistola rociadora ajustable
CN 调节式水枪

AI ABS

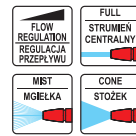

TIED ON CARD



YATO **YT-8955** 12/48

GB Adjustable spray gun
D Regelbare Sprühpistole
PL Pistolet zraszający regulowany
RUS Регулируемый оросительный пистолет
CZ Kropící pistole regulovatelná

H Öntöző pisztoly, állítható sugarú
RO Pistolet de irigare ajustabil
F Pistolet d'arrosage réglé
I Pistola a spruzzo regolabile
E Pistola rociadora ajustable
CN 调节式水枪

AI ABS

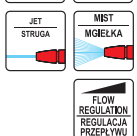

TIED ON CARD



YATO **YT-8966** 12/48

GB Adjustable spray gun
D Regelbare Sprühpistole
PL Pistolet zraszający regulowany
RUS Регулируемый оросительный пистолет
CZ Kropící pistole regulovatelná

H Öntöző pisztoly, állítható sugarú
RO Pistolet de irigare ajustabil
F Pistolet d'arrosage réglé
I Pistola a spruzzo regolabile
E Pistola rociadora ajustable
CN 调节式水枪

AI ABS

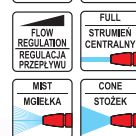

TIED ON CARD



YATO **YT-8956** 12/48

GB Adjustable spray gun
D Regelbare Sprühpistole
PL Pistolet zraszający regulowany
RUS Регулируемый оросительный пистолет
CZ Kropící pistole regulovatelná

H Öntöző pisztoly, állítható sugarú
RO Pistolet de irigare ajustabil
F Pistolet d'arrosage réglé
I Pistola a spruzzo regolabile
E Pistola rociadora ajustable
CN 调节式水枪



TIED ON CARD



YATO
YT-8957 12/48

GB Adjustable spray gun
D Regelbare Sprühpistole
PL Pistolet zraszający regulowany
RUS Регулируемый оросительный пистолет
CZ Kropící pistole regulovatelná
H Öntöző pisztoly, állítható sugarú

RO Pistolet de irigare ajustabil
F Pistolet d'arrosage réglé
I Pistola a spruzzo regolabile
E Pistola rociadora ajustable
CN 调节式水枪

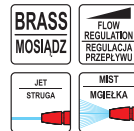

TIED ON CARD



YATO
YT-8967 12

GB Multifunction sprinkling gun
D Multifunktions-Spritzpistole
PL Wielofunkcyjny pistolet zraszający
RUS Многофункциональный оросительный пистолет
CZ Multifunkční postřikovací pistole
H Többfunkciós öntöző pisztoly

RO Pistol multifuncțional pt. pulverizare
F Pistolet d'arrosage
I Multifunzione pistola a spruzzo
E Pistola para regar multifuncional
CN 六用途调节式水枪



TIED ON CARD



YATO
YT-8958 12/48

GB Multifunction sprinkling gun
D Multifunktions-Spritzpistole
PL Wielofunkcyjny pistolet zraszający
RUS Многофункциональный оросительный пистолет
CZ Multifunkční postřikovací pistole
H Többfunkciós öntöző pisztoly

RO Pistol multifuncțional pt. pulverizare
F Pistolet d'arrosage
I Multifunzione pistola a spruzzo
E Pistola para regar multifuncional
CN 六用途调节式水枪

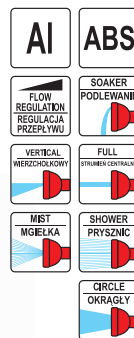

TIED ON CARD



YATO
YT-8964 12/48

GB Multifunction sprinkling gun
D Multifunktions-Spritzpistole
PL Wielofunkcyjny pistolet zraszający
RUS Многофункциональный оросительный пистолет
CZ Multifunkční postřikovací pistole
H Többfunkciós öntöző pisztoly

RO Pistol multifuncțional pt. pulverizare
F Pistolet d'arrosage
I Multifunzione pistola a spruzzo
E Pistola para regar multifuncional
CN 六用途调节式水枪

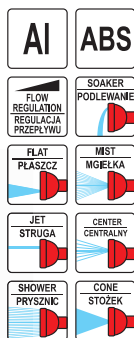

TIED ON CARD



YATO
YT-8963 12/48

GB Multifunction sprinkling gun
D Multifunktions-Spritzpistole
PL Wielofunkcyjny pistolet zraszający
RUS Многофункциональный оросительный пистолет
CZ Multifunkční postřikovací pistole
H Többfunkciós öntöző pisztoly

RO Pistol multifuncțional pt. pulverizare
F Pistolet d'arrosage
I Multifunzione pistola a spruzzo
E Pistola para regar multifuncional
CN 六用途调节式水枪

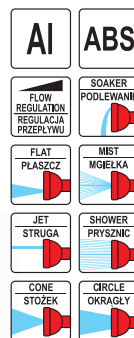

TIED ON CARD



YATO
YT-8959 12/48

GB Multifunction sprinkling gun
D Multifunktions-Spritzpistole
PL Wielofunkcyjny pistolet zraszający
RUS Многофункциональный оросительный пистолет
CZ Multifunkční postřikovací pistole
H Többfunkciós öntöző pистолы

RO Pistol multifuncțional pt. pulverizare
F Pistolet d'arrosage
I Multifunzione pistola a spruzzo
E Pistola para regar multifuncional
CN 六用途调节式水枪



TIED ON CARD



YATO **YT-8960** 12/48

GB Multifunction sprinkling gun
D Multifunktions-Spritzpistole
PL Wielofunkcyjny pistolet zraszający
RUS Многофункциональный оросительный пистолет
CZ Multifunkční postřikovací pistole
H Többfunkciós öntöző pистолы

RO Pistol multifuncțional pt. pulverizare
F Pistolet d'arrosage
I Multifunzione pistola a spruzzo
E Pistola para regar multifuncional
CN 六用途调节式水枪



TIED ON CARD



YATO **YT-99841** 12/48

GB Multifunction sprinkling gun
D Multifunktions-Spritzpistole
PL Wielofunkcyjny pistolet zraszający
RUS Многофункциональный оросительный пистолет
CZ Multifunkční postřikovací pistole
H Többfunkciós öntöző pистолы

RO Pistol multifuncțional pt. pulverizare
F Pistolet d'arrosage
I Multifunzione pistola a spruzzo
E Pistola para regar multifuncional
CN 六用途调节式水枪

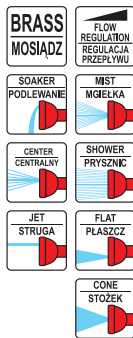

TIED ON CARD



YATO **YT-8968** 12

GB Basic hose set with straight nozzle
D Bewässerungs Spritz und Anschlussset
PL Zestaw złączek ze zraszaczem prostym
RUS Набор поливочный
CZ Postřikovač + spojky
H Készlet gyorskapoccsal csaphoz
RO Ștut furtun apă cu accesorii pt. robinet
F Set d'arrosage raccord
I Set raccordi con sprinkler semplice
E Juego de rociar tubuladura de grifo
CN 水枪组套



TIED ON CARD



YATO size / rozmiar **YT-8940** 1/2"; 3/4" 12.5; 19.0 mm 12/48

GB Basic hose set with straight nozzle
D Bewässerungs Spritz und Anschlussset
PL Zestaw złączek ze zraszaczem prostym
RUS Набор поливочный
CZ Postřikovač + spojky
H Készlet gyorskapoccsal csaphoz
RO Ștut furtun apă cu accesorii pt. robinet
F Set d'arrosage raccord
I Set raccordi con sprinkler semplice
E Juego de rociar tubuladura de grifo
CN 水枪组套

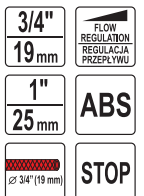

TIED ON CARD



YATO size / rozmiar **YT-8941** 3/4"; 1" 19.0 mm; 25.0 mm 12/48

GB Sprinkling lance
D Multifunktions-Spritzstab
PL Lancia zraszająca wielofunkcyjna
RUS Пика для распылителя многофункциональная

CZ Multifunkční postřikovací nadstavec
H Többfunkciós esőztető fej
RO Tijă pt. irigare
F Fusil arrosoir

I Lancia con prolunga
E Lanza para regar multifuncional
CN 长杆喷枪

TIED ON CARD

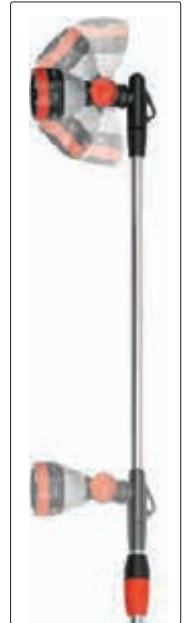

YATO	L (cm)	
YT-8962	90-135	12

GB Set of gaskets
D Dichtungssatz
PL Zestaw uszczeltek do programu wodnego
RUS Набор прокладок
CZ Sada těsnění

H Tömítéskészlet
RO Set de garnituri
F Kit de joints
I Set di guarnizioni per programma del acqua

E Juego de juntas
CN 垫圈组套

2 x Ø16 x Ø11.0 x 2.5
2 x Ø18.5 x Ø11.0 x 3.0
2 x Ø30.0 x Ø20.0 x 3.0
2 x Ø10.0 x Ø6.0 x 2.0
2 x Ø24.0 x Ø15.0 x 3.0
2 x Ø12.0 x Ø8.0 x 2.0
2 x basket



POLYBAG WITH HEADER



14
PCS

for / dla: YT-8900-YT-8994

YATO	
YT-8920	20/80

GB Impulse sprinkler
D Impulssprenger
PL Zraszacz impulsowy
RUS Распылитель импульсный на пике
CZ Postřikovač
H Impulzus szórófej
RO Stropitor apă
F Arroseur impulsion sur piquet
I Sprinkler impulso
E Rociador
CN 脉冲洒水器

MAX RANGE
ZASIEG
MAKSYMALNY
24 m

ZINC ALLOY SPIKE
KOLEC
ZE STOPU
CYNKU

ABS

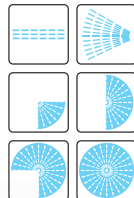

GB Impulse sprinkler
D Impulssprenger
PL Zraszacz impulsowy
RUS Распылитель импульсный на пике
CZ Postřikovač
H Impulzus szórófej
RO Stropitor apă
F Arroseur impulsion sur piquet
I Sprinkler impulso
E Rociador
CN 脉冲洒水器

MAX RANGE
ZASIEG
MAKSYMALNY
24 m

ZINC ALLOY SPIKE
KOLEC
ZE STOPU
CYNKU

ABS

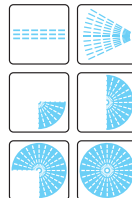

TIED ON CARD

YATO	
YT-8985	48



TIED ON CARD

YATO	
YT-8986	48

GB 3-arms revolving sprinkler
D 3-Arm Kreis-Regner
PL Zraszacz 3-ramienny
RUS Трехсторонний вращающийся распылитель на пике
CZ Rozprašovač tříramenný
H Locsoló, leszűrhető, forgó
RO Aspersol cu 3 brate
F Arroseur sur piquet 3 branches
I Tre braccio sprinkler
E Rociador 3-brazos
CN 三叉插针洒水器

MAX RANGE
ZASIEG
MAKSYMALNY
12 m

ZINC ALLOY SPIKE
KOLEC
ZE STOPU
CYNKU

ABS



TIED ON CARD

YATO	
YT-8987	48

- GB Tripod impulse sprinkler
- D Impulsregner
- PL Zraszacz impulsowy na statywie
- RUS Распылитель импульсный
- CZ Postřikovač
- H Impulzus szórófej
- RO Stropitor apă
- F Arroseur impulsion lance
- I Sprinkler impulso su un treppiede
- E Rociador
- CN 洒水器

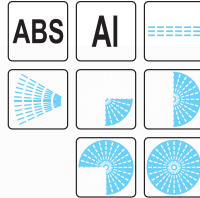

COLOR BOX

YATO	
YT-8984	12

- GB 8 pattern sprinkler
- D 8-Flächenregner
- PL Zraszacz 8-funkcyjny
- RUS Распылитель 8-позиционный на подставке
- CZ Postřikovač
- H 8 funkciós szórófej
- RO Stropitor apă cu 8 duze
- F Turbine d'arrosage 8 fonctionnes
- I Sprinkler 8-funzioni
- E Rociador 8-funciones de tierra
- CN 洒水器

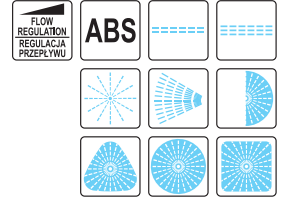

TIED ON CARD



YATO	
YT-8991	48

- GB Aluminium tube oscillating sprinkler
- D Viereckregner
- PL Zraszacz oscylacyjny z rurką aluminiową
- RUS Распылитель осциллирующий
- CZ Postrikovač
- H Oszillációs szórófej
- RO Stropitor apă
- F Arroseur oscillant aluminium
- I Oscillante sprinkler con tubo di alluminio
- E Rociador giratorio con tubo de aluminio
- CN 摇摆洒水器

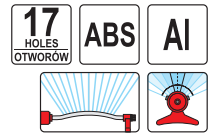

COLOR BOX

YATO	
YT-8993	6

- GB Tube oscillating sprinkler
- D Viereckregner
- PL Zraszacz oscylacyjny
- RUS Распылитель осциллирующий
- CZ Postrikovač
- H Oszillációs szórófej
- RO Stropitor apă
- F Arroseur oscillant
- I Oscillante sprinkler
- E Rociador giratorio
- CN 摇摆洒水器

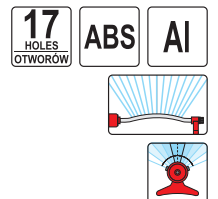

COLOR BOX

YATO	
YT-99845	6

- GB** Hose holder
D Gartenschlauchträger
PL Stojak do węża ogrodowego
RUS Барабан для намотки поливочного шланга
CZ Stojan navíjecí na zahradní hadici
H Utartódob locsolótömlőhöz
RO Suport pt. furtun
F Dévidoir sur roues
I Carrello avvolgitubo
E Estante para manguera de jardín
CN 卷线盘



COLOR BOX

YATO	hose size / rozmiar węża (m)	
YT-99850	3/4" (19.0 mm) / 45 m 1/2" (12.5 mm) / 50 m	2

- GB** Hose holder
D Gartenschlauchträger
PL Stojak do węża ogrodowego
RUS Барабан для намотки поливочного шланга
CZ Stojan navíjecí na zahradní hadici
H Utartódob locsolótömlőhöz
RO Suport pt. furtun
F Dévidoir sur roues
I Carrello avvolgitubo
E Estante para manguera de jardín
CN 卷线盘



COLOR BOX

YATO	hose size / rozmiar węża (m)	
YT-99852	3/4" (19.0 mm) / 45 m 1/2" (12.5 mm) / 50 m	2

- GB** Hose holder
D Gartenschlauchträger
PL Stojak do węża ogrodowego
RUS Барабан для намотки поливочного шланга
CZ Stojan navíjecí na zahradní hadici
H Utartódob locsolótömlőhöz
RO Suport pt. furtun
F Dévidoir sur roues
I Carrello avvolgitubo
E Estante para manguera de jardín
CN 卷线盘



COLOR BOX

YATO	hose size / rozmiar węża (m)	
YT-99853	3/4" (19.0 mm) / 60 m 1/2" (12.5 mm) / 100 m	2

- GB** Submersible pump for dirty water and wastewater
D Tauchpumpe für Schmutzwasser
PL Pompa zatapialna do wody brudnej i ścieków
RUS Погружной насос для грязной воды
CZ Ponorné čerpadlo pro odpadní vody
H Búvárszivattyú szennyvíz
RO Pompă submersibilă pt. apă uzată
F Pompe submersible pour eaux usees
I Pompa sommersa per acque reflue
E Bomba sumergible para aguas residuales
CN 污水和废水的潜水泵

COLOR BOX



230V~50Hz 750 W Q max 16000 l/h



Δ [m]	Q [l/h]
0	16000
1	15000
2	14000
3	13500
4	12500
5	11500
6	11000
7	10500
8	9500
9	8000
10	5500
11	3500
12	2000
13	500

YATO	W	l/h	H (max)	
YT-85350	750	16000	13	1

GB By-pass pruner
D Rebenschere
PL Sekator uniwersalny
RUS Секатор
CZ Nožnice zahradnicke
H Metszoolló

RO Foarfece pt. pomi
F Sécateur traditionnel
I Cesioie universale
E Podadera universal
CN 剪枝剪



YATO	L (mm)	Box
YT-8800	205	12/72

mid carbon steel blades

GB By-pass pruner
D Rebenschere
PL Sekator uniwersalny
RUS Секатор
CZ Nožnice zahradnicke
H Metszoolló

RO Foarfece pt. pomi
F Sécateur traditionnel
I Cesioie universale
E Podadera universal
CN 剪枝剪



YATO	L (mm)	Box
YT-8801	220	12/72

high carbon steel blades

GB Professional anvil pruner
D Amboss-Gartenschere
PL Sekator kowadelkowy
RUS Секатор
CZ Nožnice zahradnicke
H Metszoolló

RO Foarfece pt. pomi
F Sécateur à enclume
I Cesioie anvil
E Podadera de bigornia
CN 棘轮剪枝剪



YATO	L (mm)	Box
YT-8802	200	12/72

high carbon steel blades

GB By-pass pruner
D Rebenschere
PL Sekator uniwersalny
RUS Секатор
CZ Nožnice zahradnicke
H Metszoolló

RO Foarfece pt. pomi
F Sécateur traditionnel
I Cesioie universale
E Podadera universal
CN 剪枝剪



YATO	L (mm)	Box
YT-8805	180	12/72

high carbon steel blades

GB Ratchet by-pass pruner
D Gartenschere
PL Sekator z grzechotką
RUS Секатор
CZ Nožnice zahradnicke
H Metszoolló

RO Foarfece pt. pomi
F Sécateur à cliquet
I Cesioie con cricchetto
E Podadera con carraca
CN 棘轮剪枝剪



YATO	L (mm)	Box
YT-8807	200	12/72

GB Ratchet by-pass pruner
D Gartenschere
PL Sekator z grzechotką
RUS Секатор
CZ Nožnice zahradnicke
H Metszoolló

RO Foarfece pt. pomi
F Sécateur à cliquet
I Cesioie con cricchetto
E Podadera con carraca
CN 棘轮剪枝剪



YATO	L (mm)	Box
YT-8808	200	12/72

GB Professional anvil pruner
D Amboss-Gartenschere
PL Sekator kowadelkowy
RUS Секатор
CZ Nožnice zahradnicke
H Metszoolló

RO Foarfece pt. pomi
F Sécateur à enclume
I Cesioie anvil
E Podadera de bigornia
CN 棘轮剪枝剪



YATO	L (mm)	Box
YT-8809	210	12/72

GB By-pass pruner
D Rebenschere
PL Sekator uniwersalny
RUS Секатор
CZ Nožnice zahradnicke
H Metszoolló

RO Foarfece pt. pomi
F Sécateur traditionnel
I Cesioie universale
E Podadera universal
CN 剪枝剪



YATO	L (mm)	Box
YT-8811	190	12/72

GB By-pass pruner
D Rebenschere
PL Sekator uniwersalny
RUS Cекатор
CZ Nožnice zahradnicke
H Metszoolló

RO Foarfece pt. pomi
F Sécateur traditionnel
I Cesoia universale
E Podadera universal
CN 剪枝剪



YATO	L (mm)	
YT-8845	200	12/72

GB By-pass pruner
D Rebenschere
PL Sekator uniwersalny
RUS Cекатор
CZ Nožnice zahradnicke
H Metszoolló

RO Foarfece pt. pomi
F Sécateur traditionnel
I Cesoia universale
E Podadera universal
CN 剪枝剪



YATO	L (mm)	
YT-8790	200	12/60

GB Fruit and flower shears
D Blumen- und Rebschere
PL Sekator do obcinania zawiązków
RUS Cекатор
CZ Nožnice zahradnicke
H Metszoolló

RO Foarfece pt. pomi
F Sécateur
I Cesoia taglio gemme
E Podadera para cortar germenos
CN 花枝剪



YATO	L (mm)	
YT-8791	200	12/60

GB Fruit and flower shears
D Blumen- und Rebschere
PL Sekator do obcinania zawiązków
RUS Cекатор
CZ Nožnice zahradnicke
H Metszoolló

RO Foarfece pt. pomi
F Sécateur
I Cesoia taglio gemme
E Podadera para cortar germenos
CN 花枝剪



YATO	L (mm)	
YT-8815	180	12/72

GB Fruit and flower shears
D Blumen- und Rebschere
PL Sekator do obcinania zawiązków
RUS Cекатор
CZ Nožnice zahradnicke
H Metszoolló

RO Foarfece pt. pomi
F Sécateur
I Cesoia taglio gemme
E Podadera para cortar germenos
CN 花枝剪



YATO	L (mm)	
YT-8816	190	12/72

GB Fruit and flower shears
D Blumen- und Rebschere
PL Sekator do obcinania zawiązków
RUS Cекатор
CZ Nožnice zahradnicke
H Metszoolló

RO Foarfece pt. pomi
F Sécateur
I Cesoia taglio gemme
E Podadera para cortar germenos
CN 花枝剪



YATO	L (mm)	
YT-8817	190	12/72

GB By-pass pruner
D Rebenschere
PL Sekator uniwersalny
RUS Cекатор
CZ Nožnice zahradnicke
H Metszoolló

RO Foarfece pt. pomi
F Sécateur traditionnel
I Cesoia universale
E Podadera universal
CN 剪枝剪



YATO	L (mm)	
YT-8843	180	5/60

GB By-pass pruner
D Rebenschere
PL Sekator uniwersalny
RUS Cекатор
CZ Nožnice zahradnicke
H Metszoolló

RO Foarfece pt. pomi
F Sécateur traditionnel
I Cesoia universale
E Podadera universal
CN 剪枝剪



YATO	L (mm)	
YT-8849	200	12/72

GB By-pass lopping shears
D Astschere
PL Sekator do gałęzi
RUS Сучкорез
CZ Nožnice zahradnicke
H Ágvágó fix
RO Foarfeca curbata pt. taiat crengi

F Coupe-branches à lame franche
I Cesoia tagliarami
E Podadera para ramas
CN 高枝剪

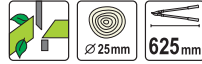

HANGING CARD & POUCH ON BLADE

YATO	L (mm)	
YT-8831	625	12

1050 mid carbon steel blades

GB Anvil lopping shears
D Amboss Astschere
PL Sekator kowadelkowy do gałęzi
RUS Сучкорез
CZ Nožnice zahradnicke
H Ágvágó fix
RO Foarfeca curbata pt. taiat crengi

F Coupe-branches à éclume
I Cesoia anvil tagliarami
E Podadera para ramas, de bigornia
CN 高枝剪



HANGING CARD & POUCH ON BLADE

YATO	L (mm)	
YT-8832	635	12

1050 mid carbon steel blades

GB By-pass lopping shears
D Astschere
PL Sekator do gałęzi
RUS Сучкорез
CZ Nožnice zahradnicke
H Ágvágó fix
RO Foarfeca curbata pt. taiat crengi

F Coupe-branches à lame franche
I Cesoia tagliarami
E Podadera para ramas
CN 高枝剪



HANGING CARD & POUCH ON BLADE

YATO	L (mm)	
YT-8833	705	12

1050 mid carbon steel blades

GB Anvil lopping shears
D Amboss Astschere
PL Sekator kowadelkowy do gałęzi
RUS Сучкорез
CZ Nožnice zahradnicke
H Ágvágó fix
RO Foarfeca curbata pt. taiat crengi

F Coupe-branches à éclume
I Cesoia anvil tagliarami
E Podadera para ramas, de bigornia
CN 高枝剪



HANGING CARD & POUCH ON BLADE

YATO	L (mm)	
YT-8834	700	12

1050 mid carbon steel blades

GB By-pass lopping shears
D Astschere
PL Sekator do gałęzi
RUS Сучкорез
CZ Nožnice zahradnicke
H Ágvágó fix
RO Foarfeca curbata pt. taiat crengi

F Coupe-branches à lame franche
I Cesoia tagliarami
E Podadera para ramas
CN 高枝剪



HANGING CARD & POUCH ON BLADE

YATO	L (mm)	
YT-8835	780	12

1050 mid carbon steel blades

GB Anvil lopping shears
D Amboss Astschere
PL Sekator kowadelkowy do gałęzi
RUS Сучкорез
CZ Nožnice zahradnicke
H Ágvágó fix
RO Foarfeca curbata pt. taiat crengi

F Coupe-branches à éclume
I Cesoia anvil tagliarami
E Podadera para ramas, de bigornia
CN 高枝剪



HANGING CARD & POUCH ON BLADE

YATO	L (mm)	
YT-8836	770	12

1050 mid carbon steel blades

GB Telescopic by-pass lopping shears
D Astschere
PL Sekator teleskopowy do gałęzi
RUS Секатор с телескопическими ручками
CZ Nožnice zahradnicke
H Ágvágó teleszkópos
RO Foarfeca curbata pt. taiat crengi
F Coupe-branches télescopique
I Cesoia tagliarami telescopica
E Podadera telescópica para ramas
CN 可伸缩高枝剪



HANGING CARD & POUCH ON BLADE

YATO	L (mm)	
YT-8838	630-960	6/12

mid carbon steel blades

GB Telescopic by-pass lopping shears
D Astschere
PL Sekator teleskopowy do gałęzi
RUS Секатор с телескопическими ручками
CZ Nožnice zahradnicke
H Ágvágó teleszkópos

RO Foarfeca curbata pt. taiat crengi
F Coupe-branches télescopique
I Cesoie tagliarami telescopica
E Podadera telescópica para ramas
CN 可伸缩高枝剪



HANGING CARD & POUCH ON BLADE

YATO	L (mm)	
YT-8839	650-900	6

GB Telescopic by-pass lopping shears
D Astschere
PL Sekator teleskopowy do gałęzi
RUS Секатор с телескопическими ручками
CZ Nožnice zahradnicke
H Ágvágó teleszkópos

RO Foarfeca curbata pt. taiat crengi
F Coupe-branches télescopique
I Cesoie tagliarami telescopica
E Podadera telescópica para ramas
CN 可伸缩高枝剪



HANGING CARD & POUCH ON BLADE

YATO	L (mm)	
YT-8840	640-885	12

GB Telescopic by-pass lopping shears
D Astschere
PL Sekator teleskopowy do gałęzi
RUS Секатор с телескопическими ручками
CZ Nožnice zahradnicke
H Ágvágó teleszkópos

RO Foarfeca curbata pt. taiat crengi
F Coupe-branches télescopique
I Cesoie tagliarami telescopica
E Podadera telescópica para ramas
CN 可伸缩高枝剪



HANGING CARD & POUCH ON BLADE

YATO	L (mm)	
YT-8841	690-930	6

GB Telescopic by-pass lopping shears
D Astschere
PL Sekator teleskopowy do gałęzi
RUS Секатор с телескопическими ручками
CZ Nožnice zahradnicke
H Ágvágó teleszkópos

RO Foarfeca curbata pt. taiat crengi
F Coupe-branches télescopique
I Cesoie tagliarami telescopica
E Podadera telescópica para ramas
CN 可伸缩高枝剪



HANGING CARD & POUCH ON BLADE

YATO	L (mm)	
YT-8842	660-910	12

GB Leverage tree pruner
D Baumsäge mit astschere
PL Sekator gašienicowy z piłą
RUS Сучкорез штанговый с пилой
CZ Střiháč na větve s pilovým listem
H Kötteles ágvágó
RO Fierastrau pt. pomi cu prelungitor
F Système de scie à poulie
I Taglio pista con sega
E Podadera de palanca con sierra
CN 高枝锯



DOUBLE BLISTER

YATO	L (mm)	
YT-8876	325	12

GB Hedge shears
D Heckenschere
PL Nożyce do żywopłotu
RUS Кусторезы
CZ Nožnice na živý plot
H Sónvényvágó olló

RO Foarfeca pt. gard viu
F Cisaille à haie
I Cesioie per le siepe
E Tijeras para seto vivo
CN 整篱剪

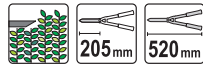

HANGING CARD & POUCH ON BLADE

YATO	L (mm)	
YT-8821	520	24

1050 mid carbon steel blades

GB Hedge shears
D Heckenschere
PL Nożyce do żywopłotu
RUS Кусторезы
CZ Nožnice na živý plot
H Sónvényvágó olló
RO Foarfeca pt. gard viu

F Cisaille à haie
I Cesioie per le siepe
E Tijeras para seto vivo
CN 整篱剪



HANGING CARD & POUCH ON BLADE

YATO	L (mm)	
YT-8822	550	12

1050 mid carbon steel blades

GB Hedge shears
D Heckenschere
PL Nożyce do żywopłotu
RUS Кусторезы
CZ Nožnice na živý plot
H Sónvényvágó olló

RO Foarfeca pt. gard viu
F Cisaille à haie
I Cesioie per le siepe
E Tijeras para seto vivo
CN 整篱剪

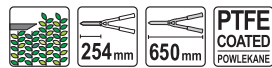

HANGING CARD & POUCH ON BLADE

YATO	L (mm)	
YT-8823	650	12

1050 mid carbon steel blades

GB Telescopic hedge shears
D Heckenschere
PL Teleskopowe nożyce do żywopłotu
RUS Кусторезы с телескопическими ручками
CZ Nožnice na živý plot
H Sónvényvágó olló

RO Foarfeca pt. gard viu
F Cisaille télescopique à haie
I Cesioie telescopiche per siepe
E Tijeras para seto vivo
CN 可伸缩整篱剪

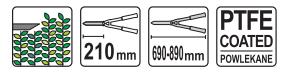

HANGING CARD & POUCH ON BLADE

YATO	L (mm)	
YT-8824	690-890	6

50 mid carbon steel blades

GB Grass shears
D Handgrassschere
PL Nożyce do trawy wielopozycyjne
RUS Ножницы для стрижки травы
CZ Nožnice na trávu
H Forgatható fűviró olló

RO Foarfeca pt. gazon
F Cisaille à gazon
I Cesioie per erba multifunzione
E Tijeras de cesped
CN 草剪



PTFE COATED POWLEKANE



TRY ME HALF BLISTER CARD

YATO	L (mm)	
YT-8851	330	12/60

1050 mid carbon steel blades

GB Grass shears
D Handgrassschere
PL Nożyce do trawy wielopozycyjne
RUS Ножницы для стрижки травы
CZ Nožnice na trávu
H Forgatható fűviró olló

RO Foarfeca pt. gazon
F Cisaille à gazon
I Cesioie per erba multifunzione
E Tijeras de cesped
CN 草剪



PTFE COATED POWLEKANE



TRY ME HALF BLISTER CARD

YATO	L (mm)	
YT-8852	310	6/24

1050 mid carbon steel blades

GB Grass shears
D Handgrassschere
PL Nożyce do trawy wielopozycyjne
RUS Ножницы для стрижки травы
CZ Nožnice na trávu
H Forgatható fűviró olló

RO Foarfeca pt. gazon
F Cisaille à gazon
I Cesioie per erba multifunzione
E Tijeras de cesped
CN 草剪



S50C PTFE COATED POWLEKANE



TRY ME HALF BLISTER CARD

YATO	L (mm)	
YT-8853	370	6/72

- GB** Bow saw
D Bügelsäge
PL Piła kabląkowa
RUS Лучковая пила
CZ Oblouková pila
H Keretes fűrés
- RO** Ferăstrău de curbură
F Scie à bûches
I Sega ad arco
E Sierra de arco
CN 两用弓锯

COLOR SLEEVE



HCS 65



2
FUNCTION

FOR WOOD AND METAL
DO DREWNA I METALU

FOR WOOD
DO DREWNA

YATO	L (mm)	
YT-3200	300	12/24

YATO	L (mm)	
YT-3201	450	12/24
YT-3202	530	
YT-3203	610	
YT-3204	760	

- GB** Blade for dry wood
D Trockenholzsägeblatt für Handsäge
PL Brzeczot do drewna suchego
RUS Лезвие для работы по сухому дереву
CZ Pilový list na suché dřevo
- H** Fűrészlap száraz fához
RO Lama pt. lemn uscat
F Lame à bois sec
I Lama per il legno secco
E Hoja de sierra para madera seca
CN 干木锯条

HCS 65

DRY WOOD
DREWNO SUCHE



COLOR SLEEVE

YATO	L (mm)	
YT-3221	450	50/200
YT-3222	530	
YT-3223	610	
YT-3224	760	

- GB** Blade for wet wood
D Nassholzsägeblatt für Handsäge
PL Brzeczot do drewna mokrego
RUS Лезвие для работы по влажному дереву
CZ Pilový list na mokré dřevo
- H** Fűrészlap nedves fához
RO Lama pt. lemn verde
F Lame à bois humide
I Lama per il legno bagnato
E Hoja de sierra para madera mojada
CN 湿木锯条

HCS 65

WET WOOD
DREWNO MOKRE



COLOR SLEEVE

YATO	L (mm)	
YT-3230	300	50/200
YT-3231	450	
YT-3232	530	
YT-3233	610	
YT-3234	760	

- GB** Axe
D Beil Hicorystiel
PL Siekiera
- RUS** Tonop
CZ Sekerka
H Szekece
- RO** Secure
F Hache
I Ascia
- E** Hacha
CN 把斧

DIN 5131
7294

GENUINE HICKORY

Timber wedge and steel ring
Drewniany klin ze stalowym pierścieniem

Genuine hickory shaft
Trzonek z hikorzy



Forged carbon steel head hardened and tempered
Głowica z kutej stali węglowej, hartowana i utwardzona

YATO	m (g)	L (mm)	DIN	
YT-8001	600	360	5131	24
YT-8002	800	380	5131	20
YT-8003	1000	430	5131	12
YT-8004	1250	710	7294	12
YT-8005	1400	710	7294	12
YT-8006	1600	810	7294	12

- GB** Axe
D Beil Hicorystiel
PL Siekiera
- RUS** Tonop
CZ Sekerka
H Szekece
- RO** Secure
F Hache
I Ascia
- E** Hacha
CN 把斧

GENUINE HICKORY

Timber wedge and steel ring
Drewniany klin ze stalowym pierścieniem

Genuine hickory shaft
Trzonek z hikorzy



Forged carbon steel head hardened and tempered
Głowica z kutej stali węglowej, hartowana i utwardzona

YATO	m (g)	L (mm)	
YT-8011	1000	515	6
YT-8012	2000	820	6

GB Transplanter
 D Blumenkelle
 PL Łopatka
 RUS Совок посадочный
 CZ Lopatka
 H Ásó
 RO Mini-lopata gradinarit
 F Transplantoir
 I Spatola
 E Paleta estrecha
 CN 移植器

350 mm

CARBON STEEL



YATO	L (mm)	
YT-8865	350	10/60

GB Rake
 D Blumenrechen
 PL Grabki
 RUS Грабли
 CZ Hrabičky
 H Gereblye
 RO Mini grebla
 F Râteau
 I Rastrelli
 E Rastrillo
 CN 园艺耙

325 mm

CARBON STEEL



YATO	L (mm)	
YT-8866	325	10/60

GB 3-tine fork & rake
 D Kleinhacke
 PL Motyczka + pazurki
 RUS Рыхлитель комбинированный
 CZ Motyčka s kultivátorem
 H Kapa és kultivátor
 RO Sapaliga + cultivator
 F Râteau et bêche
 I Zappa + artigli
 E Escarificador tres dienetes con azadilla
 CN 园艺耙

310 mm

CARBON STEEL



YATO	L (mm)	
YT-8867	310	10/60

GB Cultivator
 D Grubber
 PL Pazurki
 RUS Рыхлитель
 CZ Kultivátor
 H Kultivátor
 RO Cultivator
 F Griffes piocheuse
 I Artigli
 E Escarificador
 CN 园艺耙

420 mm

CARBON STEEL



YATO	L (mm)	
YT-8868	420	10/60

GB Garden rake
 D Landschaftsbesen
 PL Grabki wachlarzowe
 RUS Грабли веерные
 CZ Hrabičky
 H Kerti gereblye
 RO Grebla de gradina
 F Râteau
 I Rastrelli ventilatore
 E Rastrillo de abanico de hojalata
 CN 园艺耙

400 mm

CARBON STEEL



YATO	L (mm)	
YT-8869	400	10/60

GB Transplanter
 D Blumenkelle
 PL Łopatka
 RUS Совок посадочный
 CZ Lopatka
 H Ásó
 RO Mini-lopata gradinarit
 F Transplantoir
 I Spatola
 E Paleta estrecha
 CN 移植器

360 mm

CARBON STEEL



YATO	L (mm)	
YT-8870	360	10/60

GB Transplanter
 D Blumenkelle
 PL Łopatka
 RUS Совок посадочный
 CZ Lopatka
 H Ásó
 RO Mini-lopata gradinarit
 F Transplantoir
 I Spatola
 E Paleta estrecha
 CN 移植器

340 mm

CHROME PLATED



YATO	L (mm)	
YT-8885	340	12/72

GB Transplanter
 D Blumenkelle
 PL Łopatka
 RUS Совок посадочный
 CZ Lopatka
 H Ásó
 RO Mini-lopata gradinarit
 F Transplantoir
 I Spatola
 E Paleta estrecha
 CN 移植器

340 mm

CHROME PLATED



YATO	L (mm)	
YT-8886	340	12/72

GB Hoe
 D Garten handhacke
 PL Motyczka
 RUS Мотыжка
 CZ Motyčka
 H Kerti kapa
 RO Sapaliga
 F Binette
 I Zappetta
 E Azadilla
 CN 园艺锄

280 mm

CHROME PLATED



YATO	L (mm)	
YT-8889	280	12/72

GB Cultivator
 D Grubber
 PL Pazurki
 RUS Рыхлитель
 CZ Kultivátor
 H Kultivátor
 RO Cultivator
 F Griffes piocheuse
 I Artigli
 E Escarificador
 CN 园艺耙

270 mm

CHROME PLATED



YATO	L (mm)	
YT-8890	270	12/72

GB Rolling tiller
 D Rollpflüger
 PL Spulchniacz
 RUS Рыхлитель дисковый
 CZ Kypřič púdy
 H Görögös talajjazító
 RO Maruntitor pt. pamant
 F Émietteur
 I Coltivatore
 E Escarificador
 CN 松土器

370 mm

CHROME PLATED



YATO	L (mm)	
YT-8891	370	12/72

GB Hoe + cultivator
 D Kleinhacke
 PL Motyczka z pazurkami
 RUS Рыхлитель комбинированный
 CZ Motyčka s hrabičkami
 H Kerti villás kapa
 RO Sapaliga + cultivator
 F Serfouette
 I Zappetta con artigli
 E Azadilla con escarificador
 CN 园艺锄

320 mm

CHROME PLATED





YATO	L (mm)	
YT-8892	320	12/72

GB Dibble
D Pflanzler
PL Pikiownik ogrodniczy
RUS Конус посадочный с деревянной ручкой
CZ Zahradnický přerichovač
H Kerti palántázó
RO Chitonag pt. grădină
F Plantoir
I Foraterra
E Picadeor de jardin
CN 挖洞器



280
mm

STAINLESS
STEEL
STAL
NIEKORZYŻNA

YATO 	L (mm)	
YT-8894	280	10/60



GB Spade
D Rodespaten
PL Szpadel
RUS Заступ
CZ Lisovaný rýč kalená
H Ásó, sajtolt-edzett
RO Hârleț cu coadă
F Bêche à bord pointu
I Spatola
E Pala
CN 铲



120
cm

HRC
40-48

1050Mn
STEEL

YATO 	L (cm)	
YT-86804	120	6



GB Spade
D Rodespaten
PL Szpadel
RUS Заступ
CZ Lisovaný rýč kalená
H Ásó, sajtolt-edzett
RO Hârleț cu coadă
F Bêche à bord droit
I Spatola
E Pala
CN 铲



120
cm

HRC
40-48

1050Mn
STEEL

YATO 	L (cm)	
YT-86800	120	6



GB Shovel
D Schaufel
PL Łopata
RUS Лопата
CZ Osazený rýč
H Homoklapát, ékelt
RO Lopată pt. nisip
F Pelle à charbon
I Palla
E Pala
CN 鏟子



120
cm

HRC
40-48

1050Mn
STEEL

YATO 	L (cm)	
YT-86801	120	6



GB Shovel
D Schaufel
PL Łopata ogrodnicza
RUS Лопата совковая песочная
CZ Osazený rýč pískový
H Homoklapát, ékelt
RO Lopată pt. nisip
F Pelle à sable
I Palla
E Pala
CN 鏟子



120
cm

HRC
40-48



1050Mn
STEEL

YATO 	L (cm)	
YT-86808	120	6

GB Digging fork
D Profi-grabegabel
PL Widły
RUS Вилы
CZ Zahradnické vidlice
H Vasvilla
RO Furcă pt. grădinărit
F Fourche à bêche
I Forchetta
E Horca
CN 铁叉





120
cm

YATO 	L (cm)	
YT-86805	120	6

GB Digging fork
D Profi-grabegabel
PL Widły
RUS Вилы
CZ Zahradnické vidlice
H Vasvilla
RO Furcă pt. grădinărit
F Fourche à bêche
I Forchetta
E Horca
CN 铁叉



120
cm

YATO 	L (cm)	
YT-86809	120	6

GB Cordless chainsaw
 D Akku-kettensäge
 PL Akumulatorowa pilarka łańcuchowa
 RUS Аккумуляторная цепная пила
 CZ Akumulátorová řetězová píla
 H Akkus lánclűrész
 RO Ferăstrăie cu lanț cu acumulator
 F Tronçonneuse
 I Motosega a batteria
 E Inalámbrico motosierra
 CN 无绳链锯



40 V	2.5 Ah	12" 30.5 cm	Li-Ion
<small>AUTOMATIC CHAIN LUBRICATION</small>	<small>TOOL-FREE ADJUSTMENT OF CHAIN TENSION</small>	<small>CHARGE LEVEL INDICATOR</small>	<small>OIL TANK</small>
<small>AUTOMATYCZNE SMAROWANIE ŁĄCZKI TRĄCZEGO</small>	<small>BEZWOLNOCIENNE REGULACJA NAJADOWANIA ŁĄCZKI</small>	<small>WSKAZNIK STANU NAJADOWANIA BATERII</small>	<small>0.18 l</small>

COLOR BOX



L_{pa} = 86.8 ± 3.0 dB;
 L_{wa} = 96.5 ± 3.0 dB;
 a_w = 3.5 ± 1.5 m/s²

YATO	V	
YT-85090	40	2

GB Battery
 D Akkumulator
 PL Akumulator
 RUS Аккумулятор
 CZ Akumulátor
 H Akkumulátor
 RO Acumulatorul
 F Batterie
 I Batteria
 E Bateria
 CN 锂电池



40 V	2.5 Ah	100 Wh
<small>CHARGE LEVEL INDICATOR</small>	<small>Li-Ion</small>	
<small>WSKAZNIK STANU NAJADOWANIA BATERII</small>	<small>Li-Ion</small>	

WHITE CARTON BOX & COLOR LABEL



for / dla: YT-85090

YATO	V	
YT-85132	40	10

GB Battery charger
 D Ladegerät
 PL Ładowarka
 RUS Зарядное устройство
 CZ Nabíječka
 H Akkutöltő
 RO Redresor
 F Chargeur de batterie
 I Caricabatteria
 E Rectificador
 CN 充电器



for/dla: 40V	230V~50Hz	for/dla: Li-Ion
1h	<small>QUICK CHARGING SYSTEM LAJAZWIANIE</small>	

WHITE CARTON BOX & COLOR LABEL



for / dla: YT-85090, YT-85132

YATO	V	
YT-85133	40	18

GB Cordless chainsaw
 D Akku-kettensäge
 PL Akumulatorowa pilarka łańcuchowa
 RUS Аккумуляторная цепная пила
 CZ Akumulátorová řetězová píla
 H Akkus lánclűrész
 RO Ferăstrăie cu lanț cu acumulator
 F Tronçonneuse
 I Motosega a batteria
 E Inalámbrico motosierra
 CN 无绳链锯



18 V	3.0 Ah	10" 25 cm	Li-Ion	<small>AUTOMATIC CHAIN LUBRICATION</small>	<small>OIL TANK</small>
				<small>AUTOMATYCZNE SMAROWANIE ŁĄCZKI TRĄCZEGO</small>	<small>0.21 l</small>

COLOR BOX



L_{pa} = 80.8 ± 3.0 dB;
 L_{wa} = 93.6 ± 3.68 dB;
 a_w = 2.53 ± 1.5 / 3.80 ± 1.5 m/s²

YATO	V	
YT-85080	18	2

GB Cordless pole saw
 D Akku-Hochentaster
 PL Akumulatorowa okrzesywarka na wysięgniku
 RUS Аккумуляторный телескопический высторез
 CZ Akumulátorová vyvčtovací píla
 H Akumulátoros magassági ágnyeső
 RO Ferăstrăie cu lanț cu telescopic
 F Elagueuse sur perche
 I Potatore a batteria
 E Sierra de pértiga telescópica
 CN 高枝锯



18 V	3.0 Ah	8" 20 cm
<small>Li-Ion</small>	<small>AUTOMATIC CHAIN LUBRICATION</small>	<small>OIL TANK</small>
	<small>AUTOMATYCZNE SMAROWANIE ŁĄCZKI TRĄCZEGO</small>	<small>0.6 l</small>

COLOR BOX



GB Cordless telescopic pole saw
 D Akku-Teleskop-Hochentaster
 PL Akumulatorowe okrzesywarka na wysięgniku
 RUS Аккумуляторный телескопический высторез
 CZ Akumulátorová teleskopická vyvčtovací píla
 H Akkus magassági ágvágvó távcsvéses
 RO Ferăstrăie cu lanț cu telescopic cu acumulator
 F Elagueuse sur perche telescopique sans-fil
 I Decescpugliatore telescopico a batteria
 E Sierra de pértiga telescópica a bateria
 CN 充电式高枝锯

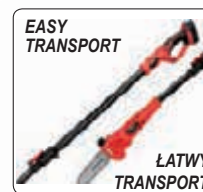

18 V	Li-Ion
2.0 Ah	1h
2500 min⁻¹	8" 20 cm
5 m/s	

L_{pa} = 78.2 ± 3.0 dB;
 L_{wa} = 91.2 ± 2.36 dB;
 a_w = 2.109 ± 1.5 m/s²



3 POSITIONS ROZWIĘZANIE

YATO	V	
YT-85120	18	2

L_{pa} = 78.8 ± 3.0 dB;
 L_{wa} = 90.7 ± 2.36 dB;
 a_w = 2.68 ± 1.5 / 4.84 ± 1.5 m/s²

18V Li-Ion

COLOR BOX

YATO	V	
YT-82836	18	2

- GB** Cordless telescopic pole saw (tool only)
D Akku-Teleskop-Hochentaster (nur das Gerät)
PL Akumulatorowe okrzyszawarka na wysięgniku (tylko narzędzie)
RUS Аккумуляторный телескопический высоторез (только инструмент)
CZ Akumulátorová teleskopická vyvívavací pila (pouze nářadí)
H Akkus magassági ágvágó távcsőves (csak a szerszámot)
RO Ferăstrăie cu lanț cu telescopic cu acumulator (numai sculă)
F Elagueuse sur perche télescopique sans-fil (outil seulement)
I Decescpugliatore telescopico a batteria (solo utensile)
E Sierra de pértiga telescópica a batería (herramienta solamente)
CN 充电式高枝锯 (光机)



battery not included
akumulatora
nie dołączono

$L_{wA} = 78.2 \pm 3.0$ dB;
 $L_{wB} = 91.2 \pm 2.36$ dB;
 $a_s = 2.109 \pm 1.5$ m/s²

* given charging
time is for 2.0 Ah
battery only

* podany czas
ładowania
dotyczy
tylko akumulatora
2.0 Ah

18V
Li-Ion!

YATO	V	COLOR BOX
YT-82837	18	2

- GB** Cordless grass trimmer
D Akku-Rasentrimmer
PL Akumulatorowa podkaszarka do trawy
RUS Аккумуляторный телескопический высоторез
CZ Akumulátorová sekačka na trávu
H Akkus szegélynyíró
RO Trimmer de gazon cu acumulator
F Coupe bordures sans fil
I Tosaerba a filo a batteria
E Desmalezadora inalámbrica
CN 打草机

COLOR BOX



$L_{wA} = 80.8 \pm 3.0$ dB;
 $L_{wB} = 88.5 \pm 2.64$ dB;
 $a_s = 4.41 \pm 1.5 / 3.33 \pm 1.5$ m/s²



YATO	V	COLOR BOX
YT-85110	18	4

- GB** Cordless grass trimmer
D Akku-Rasentrimmer
PL Akumulatorowa podkaszarka do trawy
RUS Аккумуляторный триммер (только инструмент)
CZ Akumulátorová sekačka na trávu
H Akkus szegélynyíró
RO Trimmer de gazon cu acumulator
F Débroussailleuse sans-fil
I Tagliabordi a batteria
E Desbrozadora a batería
CN 充电式打草机



$L_{wA} = 85.0 \pm 3.0$ dB;
 $L_{wB} = 93.0 \pm 3.0$ dB;
 $a_s = 2.5 \pm 1.5$ m/s²

18V
Li-Ion!

YATO	V	COLOR BOX
YT-82830	18	2

- GB** Cordless grass trimmer (tool only)
D Akku-Rasentrimmer (nur das Gerät)
PL Akumulatorowa podkaszarka do trawy (tylko narzędzie)
RUS Аккумуляторный триммер (только инструмент)
CZ Akumulátorová sekačka na trávu (pouze nářadí)
H Akkus szegélynyíró (csak a szerszámot)
RO Trimmer de gazon cu acumulator (numai sculă)
F Débroussailleuse sans-fil (outil seulement)
I Tagliabordi a batteria (solo utensile)
E Desbrozadora a batería (herramienta solamente)
CN 充电式打草机 (光机)



battery not included
akumulatora
nie dołączono

* given charging
time is for 2.0 Ah
battery only

* podany czas
ładowania dotyczy
tylko akumulatora
2.0 Ah

18V
Li-Ion!

YATO	V	COLOR BOX
YT-82831	18	2

$L_{wA} = 85.0 \pm 3.0$ dB;
 $L_{wB} = 93.0 \pm 3.0$ dB;
 $a_s = 2.5 \pm 1.5$ m/s²

GB Cordless hedge trimmer
D Akku-Heckenschere
PL Akumulatorowe nożyce do żywopłotu
RUS Аккумуляторный кусторез
CZ Akumulátorové nůžky na živé ploty
H Akkus sövénynyíró
RO Foarfece de tăiat gard viu cu acumulator

F Taille-haies sans fil
I Tagliasiepi a batteria
E Cortasetos inalámbrico
CN 充电式修枝剪



18 V **3.0 Ah** **Li-Ion**

2400 min¹ 450mm

$L_{pa} = 77,4 \pm 3,0$ dB;
 $L_{wa} = 86,5 \pm 2,07$ dB;
 $a_s = 1,96 \pm 1,5 / 2,07 \pm 1,5$ m/s²



YATO	V	
YT-85100	18	2

GB Cordless hedge trimmer
D Akku-Heckenschere
PL Akumulatorowe nożyce do żywopłotu
RUS Аккумуляторный кусторез
CZ Akumulátorové nůžky na živé ploty
H Akkus sövénynyíró
RO Foarfece de tăiat gard viu cu acumulator

I Tagliasiepi a batteria
E Cortasetos inalámbrico
CN 充电式修枝剪



18 V **Li-Ion** **2.0 Ah** **1h**

1050 min¹ 560 mm

$L_{pa} = 80,0 \pm 3,0$ dB;
 $L_{wa} = 87,0 \pm 3,0$ dB;
 $a_s = 3,5 \pm 1,5$ m/s²



YATO	V	
YT-82832	18	2

GB Cordless hedge trimmer (tool only)
D Akku-Heckenschere (nur das Gerät)
PL Akumulatorowe nożyce do żywopłotu (tylko narzędzie)
RUS Аккумуляторный кусторез (только инструмент)
CZ Akumulátorové nůžky na živé ploty (pouze nářadí)
H Akkus sövénynyíró (csak a szerszámot)
RO Foarfece de tăiat gard viu cu acumulator (numai sculă)
F Taille-haies sans-fil (outil seulement)
I Tagliasiepi a batteria (solo utensile)
E Cortasetos inalámbrico (herramienta solamente)
CN 充电式高枝剪 (光机)

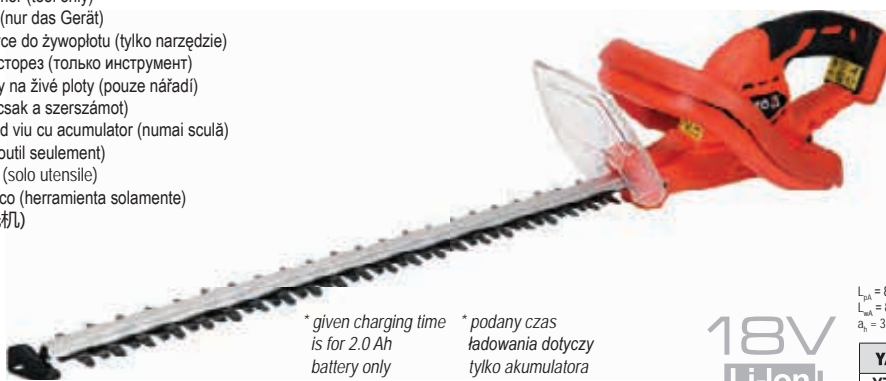

18 V **Li-Ion** **1h***

1050 min¹ 560 mm

$L_{pa} = 80,0 \pm 3,0$ dB;
 $L_{wa} = 87,0 \pm 3,0$ dB;
 $a_s = 3,5 \pm 1,5$ m/s²



YATO	V	
YT-82833	18	2

battery not included
 akumulatora
 nie dołączono

* given charging time
 is for 2.0 Ah
 battery only

* podany czas
 ładowania dotyczy
 tylko akumulatora
 2.0 Ah

GB Cordless hedge trimmer
D Akku-Heckenschere
PL Akumulatorowe nożyce do żywopłotu
RUS Аккумуляторный кусторез
CZ Akumulátorové nůžky na živé ploty
H Akkus sövénynyíró
RO Foarfece de tăiat gard viu cu acumulator
F Taille-haies sans-fil
I Tagliasiepi a batteria
E Tijera cortasetos a batería
CN 充电式高枝剪

18 V **Li-Ion** **2.0 Ah** **1h**

2100 min¹ 420 mm

GB Cordless hedge trimmer (tool only)
D Akku-Heckenschere (nur das Gerät)
PL Akumulatorowe nożyce do żywopłotu (tylko narzędzie)
RUS Аккумуляторный кусторез (только инструмент)
CZ Akumulátorové nůžky na živé ploty (pouze nářadí)
H Akkus sövénynyíró (csak a szerszámot)
RO Foarfece de tăiat gard viu cu acumulator (numai sculă)
F Taille-haies sans-fil (outil seulement)
I Tagliasiepi a batteria (solo utensile)
E Tijera cortasetos a batería (herramienta solamente)
CN 充电式高枝剪 (光机)

18 V **Li-Ion** **1h***

2100 min¹ 420 mm

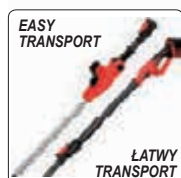

$L_{pa} = 77,3 \pm 3,0$ dB;
 $L_{wa} = 88,1 \pm 3,0$ dB;
 $a_s = 1,5 \pm 1,5$ m/s²

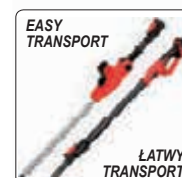
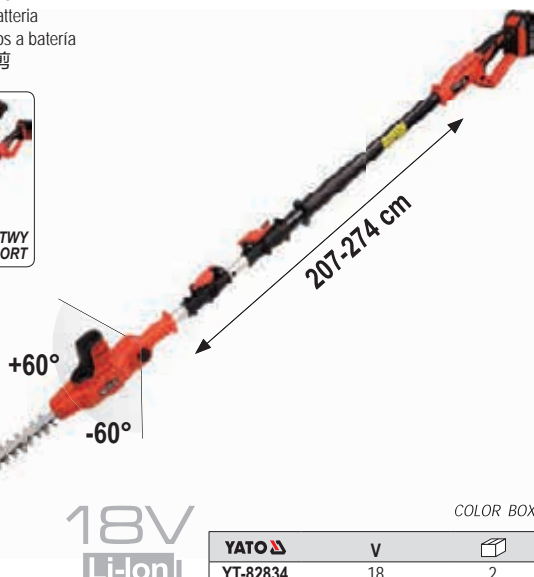

* given charging time
 is for 2.0 Ah
 battery only

* podany czas
 ładowania dotyczy
 tylko akumulatora
 2.0 Ah



$L_{pa} = 77,3 \pm 3,0$ dB;
 $L_{wa} = 88,1 \pm 3,0$ dB;
 $a_s = 1,5 \pm 1,5$ m/s²

battery not included
 akumulatora
 nie dołączono

YATO	V	
YT-82835	18	2

- GB Battery
D Akkumulator
PL Akumulator
RUS Аккумулятор
CZ Akumulátor
H Akumulátor
RO Acumulatorul
F Batterie
I Batteria
E Bateria
CN 锂电池



18 V 3.0 Ah 54 Wh Li-Ion

WHITE CARTON BOX & COLOR LABEL



for / dla: YT-85080, YT-85100, YT-85110, YT-85120

YATO	V	
YT-85130	18	18

- GB Battery
D Akkumulator
PL Akumulator
RUS Аккумулятор
CZ Akumulátor
H Akumulátor
RO Acumulatorul
F Batterie
I Batteria
E Bateria
CN 锂电池



18 V Li-Ion for/dla: Li-Ion

COLOR BOX



for / dla: YT-82830, YT-82831, YT-82832, YT-82833, YT-82834, YT-82835, YT-82836, YT-82837

YATO	V	capacity / pojemność (Ah)	charging time / czas ładowania (h)	
YT-82842	18	2.0	1.0	20
YT-82843	18	3.0	1.5	20
YT-82844	18	4.0	2.0	20

- GB Electric chainsaw
D Kettensäge
PL Piłarka elektryczna
RUS Электронпила цепная
CZ Elektrická pila
- H Elektromos fűrész
RO Ferăstrău cu lanț
F Tronçonneuse électrique
I Motosega elettrica
- E Motosierra eléctrica
CN 电链锯



2.2 kW 230V~50Hz 16" 40 cm

AUTOMATIC CHAIN LUBRICATION
AUTOMATYCZNE SMAROWANIE ŁAŃKI I ŚRĘTEK
100% FREE ADJUSTMENT OF CHAIN TENSION
100% BEZWOLNE DOPASOWANIE NAPIĘCIA ŁAŃKI I ŚRĘTEK

OIL TANK 0.23 l

COLOR BOX



L_{WA} = 87.5 ± 0.88 dB;
L_{WA} = 104.88 ± 0.88 dB;
a_v = 4.552 ± 1.5 m/s²

YATO	kW	
YT-84920	2.2	2

- GB Gasoline backpack sprayer
D Benzin Motorsprüher
PL Opryskiwacz plecakowy spalinowy
RUS Бензиновый ранец-опрыскиватель
CZ Motorový rosič
H Benzines permetező
RO Pulverizatoare pe benzina
F Pulvérisateur à essence
I Atomizzatore
E Pulverizador de gasolina
CN 喷雾喷粉机



2.13 kW 2.9 KM 41.5 cm³ 12 m max ≤3 l/min 16 l

WHITE CARTON BOX & COLOR LABEL



L_{WA} = 78.8 ± 3.0 / 97.8 ± 3.0 dB;
L_{WA} = 89.8 ± 3.0 / 108.8 ± 3.0 dB;
a_v = 1.94 ± 1.5 / 8.93 ± 1.5 m/s²

YATO	kW	KM	
YT-85140	2.13	2.9	1

- GB Gasoline chainsaw
- D Motorsägen
- PL Pilarka spalinowa
- RUS Бензопила
- CZ Motorová pila
- H Benzin láncfűrész
- RO Drujba pe benzina
- F Tronçonneuses
- I Motosega a benzina
- E Motosierra de gasolina
- CN 油锯

1.8 kW 2.4 KM	45 cm ³	C max 11000 min ⁻¹	AUTOMATIC CHAIN LUBRICATION AUTOMATYCZNE SMAROWANIE UKŁADU TŁACZEGO	ANTI-EROSION SYSTEM SYSTEM ANTYERAZYJNY	18" 44 cm
		0.325" 8.255 mm			0.058" 1.5 mm
		40 : 1			



Matching YATO bars / Pasujące prowadnice z programu YATO: YT-84934, YT-84936
 Matching YATO chains / Pasujące łańcuchy z programu YATO: YT-84940, YT-84941, YT-84942, YT-84943, YT-84944

COLOR BOX



QUICK CHANGE OF AIR FILTER
ŁATWA WYMIANA FILTRA POWIETRZA



POCKET FOR UNIVERSAL WRENCH
SCHOWEK NA KLUCZ UNIWERSALNY

L_{wa} = 90,8 ± 2,5 dB;
 L_{pa} = 109,3 ± 2,5 dB;
 a_{wa} = 6,815 ± 1,5 / 5,277 ± 1,5 m/s²

YATO	kW	KM	L (mm)	
YT-84900	1.8	2.4	440	1

- GB Gasoline chainsaw
- D Motorsägen
- PL Pilarka spalinowa
- RUS Бензопила
- CZ Motorová pila
- H Benzin láncfűrész
- RO Drujba pe benzina
- F Tronçonneuses
- I Motosega a benzina
- E Motosierra de gasolina
- CN 油锯

2.0 kW 2.7 KM	49.3 cm ³	C max 8500 min ⁻¹	AUTOMATIC CHAIN LUBRICATION AUTOMATYCZNE SMAROWANIE UKŁADU TŁACZEGO	ANTI-EROSION SYSTEM SYSTEM ANTYERAZYJNY	20" 50 cm
		0.325" 8.255 mm			0.05" 1.3 mm
		40 : 1			



Matching YATO bars / Pasujące prowadnice z programu YATO: YT-84933
 Matching YATO chains / Pasujące łańcuchy z programu YATO: YT-84945

COLOR BOX



QUICK CHANGE OF AIR FILTER
ŁATWA WYMIANA FILTRA POWIETRZA



POCKET FOR UNIVERSAL WRENCH
SCHOWEK NA KLUCZ UNIWERSALNY

L_{wa} = 106,5 ± 3 dB;
 L_{pa} = 114,4 ± 3 dB;
 a_{wa} = 6,9 ± 1,5 / 9,4 ± 1,5 m/s²

YATO	kW	KM	L (mm)	
YT-84905	2.0	2.7	500	1

- GB** Brushcutter
D Motorsensen
PL Kosa spalinowa
RUS Бензокоса
CZ Motorový křovinořez
H Motoros kasza
RO Motocoasa
I Falce fienai a benzina
E Motoguadaña de gasolina
CN 割草机



1.25 kW	42.7 cm ²
1.7 KM	
255 mm	430 mm
40 : 1	1L

L_{pa} = 88,59 ± 5,29 dB;
L_{wa} = 106,65 ± 5,29 dB;
a_s = 12,479 ± 1,5 / 4,692 ± 1,5 m/s²

YATO	kW	KM	
YT-85000	1.25	1.7	1

COLOR BOX

- GB** Brushcutter
D Motorsensen
PL Kosa spalinowa
RUS Бензокоса
CZ Motorový křovinořez
H Motoros kasza
RO Motocoasa
I Falce fienai a benzina
E Motoguadaña de gasolina
CN 割草机



1.4 kW	51.7 cm ²
1.9 KM	
255 mm	430 mm
40 : 1	1L

L_{pa} = 94,35 ± 2,5 dB;
L_{wa} = 108,67 ± 2,5 dB;
a_s = 4,512 ± 1,5 / 4,319 ± 1,5 m/s²

YATO	kW	KM	
YT-85002	1.4	1.9	1

COLOR BOX

- GB** Petrol hedge trimmer
D Benzin-Heckenscheren
PL Spalinowe nożyce do żywoplotu
RUS Бензоножницы
CZ Plotostřih na živé ploty
H Benzines sövényvágó

- RO** Tuns gard viu
F Taille-haie
I Tosasieci per privati
E Corta sebes a gasolina
CN 绿篱剪



0.7 kW	25.4 cm ²	7000min ^{max}	550mm
0.99 KM			
1850 min ⁻¹	40 : 1		0.6L

L_{pa} = 96 ± 3 dB;
L_{wa} = 105,3 ± 0,48 dB;
a_s = 6,9 ± 1,5 m/s²

YATO	kW	KM	L (mm)	
YT-85021	0.7	0.99	550	1

COLOR BOX

- GB** Chainsaw guide bar
D Kettensägeföhrung
PL Prowadnica do pił łańcuchowych
RUS Шина для бензопил

- CZ** Vodičí lišta k řetězové pile
H Lánçvezető
RO Lama de ghidai pt. ferastrau
F Guide de tronçonneuse

- I** Barra per motosega
E Barra guía motosierra
CN 导板

COLOR PAPER POUCH



for / dla: YT-84950, YT-84960

competitors / odpowiedniki: Oregon: 140SPEA074; Alpina: 4112560; Stihl: 3005 000 809; Windsor: 14ST50SSR
for / dla: Alpina: 270, 280, Elletra 160, Elletra 170, Energy 1.6, Energy 1.8, P360, P361, P370, P390, P391, Sinergy 35, Sinergy 40; Oleo-Mac: 240, OEM200; Stihl: 009, 010, 011, 012, 017, 018, 019, 019T, 020, 020T, 021, 021C, 023, 025, 25, MS160, MS170, MS180, MS181, MS191, MS192, MS200, MS200T, MS210, MS211, MS230, MS231, MS241, MS250, MS251, MSE140, MSE200

14"	36 cm	9.32 mm	0.322"	8.2 mm	Mn 65
36 cm					
50	0.05"	1.3 mm	4 RIVETS	4 NITY	
	ROLLER BEARING	ŁOŻYSKO WALECZKOWE			

YATO	size / rozmiar	
YT-84930	14" (36 cm)	20

for / dla: YT-84951, YT-84960

competitors / odpowiedniki: Oregon: 140SDEA041; Oleo-mac: 50030218; Husqvarna: 501854149; Windsor: 14PKU50SSR; Makita: 442035661, 472035661, 482035661; Alpina: 4112300; Dolmar: 412035661, 452035661, 462035661; Partner: 530044328
for / dla: Al-Ko: 2000, 2300, 25A, E1200, E125, E1400, E1500, KE3500, VARIO, KE4000, KS, KSB; Alpina: 352, 382, A10E, A14E, E120, E130, E150, ELECTRIC, ES182, ES202, KS1400B, KS1500B; Bosch: 1586, 40-19PRO, AKE30B, AKE30Li, AKE35-19PRO, AKE35B, AKE40B, BULLCRAFT, GKE35BC, GKE40BC, PKE25, PKE30B, PKE35B, PKE40; Dolmar: 100, 101, 102, 103, 104, 105, 106, 108, 275, 285, ES140, ES151, ES152, ES152A, ES153, ES160, ES161, ES162, ES162A, ES163, ES172, ES172A, ES173, ES183, ES2035, ES2040, ES3, ES30, ES37, ES40, ES41, ES6, PS33, PS330, PS330TH, PS34, PS340, PS341, PS3410, PS344, PS350, PS390, PS400, PS401, PS41, PS45; Echo: CS2600ES, CS260TES, CS2700ES, CS-310WES, CS3500ES, CS350WES, CS351WES; Einhell: BG-EC-1840TC, BG-PC-4040, EKS1650, KSE, KSE1435, KSE1635, KSE1640, KSE2000, PES1540, PES1640, PES30, PES34, PES35, PES40, PKS1635, PKS1840, PROF; Hitachi: CS280A, CS280B, CS30EH, CS350A, CS350B, CS35B; Homelite: 20AV, 23AV, 27, 3300, 3335, 350, 3550, 3800, 3850, 4500, 4550, S40, HCS3335, HCS4041CA, PS33, RANGER, TIMBERMAN, UT10901, UT10926, UT10974; Husqvarna: 23, E16, E316, E317, E321, T425; Jonsered: 2033TH; Makita: 5012, 5014, 5016, BUC122RFE, BUC250RDE, DCS232T, DCS300, DCS330S, DCS340, DCS341, DCS3410TH, DCS350, DCS3501, DCS380, DCS390, DCS400, DCS401, DCS4610, EA3201, EA3500F35B, EA3500F40B, UC250DWB, UC3000, UC3030A, UC3500, UC3501, UC3520A, UC3530AK, UC4000, UC4020A, UC4030AK, UC4530A; McCulloch: 10-42, 10-49, 335, 435, 440, 441, 442, 4600, 4700, 4900, 5000, 738, TIMBERBEAR-849, TITAN41, TITAN46; Oleo-Mac: 931, 932, GS35, GS350, GS370, GS410C; Partner: 330, 335, 340, 345, 350, 351, 352, 360, 370, 385, 391, 395, P390, P420, P842; Ryobi: APR02, PCN3335; Skil: 1620U, 1634U, 1636U



14"	36 cm	9.32 mm	0.322"	8.2 mm	Mn 65
36 cm					
52	0.05"	1.3 mm	4 RIVETS	4 NITY	
	ROLLER BEARING	ŁOŻYSKO WALECZKOWE			

YATO	size / rozmiar	
YT-84931	14" (36 cm)	20

GB Chainsaw guide bar
D Kettensägeführung
PL Prowadnica do pił łańcuchowych
RUS Шина для бензопил

CZ Vodící lišta k řetězové pile
H Lánvezető
RO Lama de ghidai pt. ferastrau
F Guide de tronçonneuse

I Barra per motosega
E Barra guía motosierra
CN 导轨

COLOR PAPER POUCH

Mn
65



for / dla: YT-84961

competitors / odpowiedniki: Oregon: 158SLHD009; Husqvarna: 508914356; Windsor: 15HS58SPNA

for / dla: Alpina: P660, P680, P700, P750, P800, PROF700, PROF800; Dolmar: PS6400, PS6400H, PS7300, PS7300H, PS7900, PS7900H, PS9000, PS9010; Dolpima: PS190, PS290, PS390, PS490; Echo: CS3500, CS3500WES, CS351WE; Husqvarna: 1100, 160, 162, 181, 2100XP, 2101, 2101XP, 260, 266, 268, 272, 281XP, 285, 288XP, 298, 298X, 298XG, 3120, 3120XP, 365, 371, 371XP, 371XP6, 372, 372XP, 372XP6, 380, 385, 385XP, 394, 394XP, 394XP6, 395, 395XP, 395XP6, 480, 562XP, 570, 575, 575XP, 576XP, 61, 64, 65, 66, 70, 77; Jonsered: 1020, 2065, 2071, 2077, 2083, 2094, 2095, 2165, 2171, 2186, 625, 630, 630 SUPER, 670, 670 CHAMP, 820; Makita: DCS6400, DCS6401, DCS7300, DCS7301, DCS7900, DCS7901, DCS9000, DCS9010; Partner: 660, 710, P7700; Solo: 603, 662, 665, 667, 670, 675, 680, 681, 690, 694

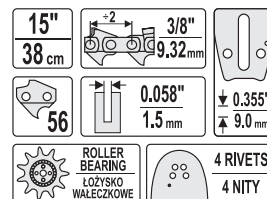

YATO	size / rozmiar	
YT-84932	15" (38 cm)	20



for / dla: YT-84905, YT-84945, YT-84962

competitors / odpowiedniki: Oregon: 50MLBK095; Dolmar: 415038631; Husqvarna: 508926164, 508926364; Makita: 445038141; Windsor: 15CJL50SPYJ

for / dla: Dolmar: 109, 110, 111, 112, 113, 114, 115, 116, PS460, PS4600, PS4605, S500, PS5000, PS510, PS5100S, PS540; Husqvarna: 133, 136, 137, 141, 142, 154, 234, 238, 240, 242, 242XP, 246, 254, 257, 261, 262, 339XP, 340, 345, 346, 346XP, 350, 351, 353, 357, 357XP, 359, 36, 40, 41, 42, 435, 435E, 44, 440E, 444, 445, 445E, 45, 450E, 455 RANCHER, 455E RANCHER, 460, 460 RANCHER, 50, 51, 550, 560XP, T435; Jonsered: 2012, 2014, 2015, 2016, 2036, 2040, 2041, 2045, 2050, 2051, 2054, 2055, 2063, 2141, 2145, 2147, 2149, 2150, 2152, 2153, 2155, 2156, 2159, 2163, 370, 380, 410, 420, 425, 435, 45, 450, 451, 451EVS, 452, 455, 490, 49SP, 50, 51, 510, 52, 520, 521, 525, 535, 590, CS2149W, CS2152W; Makita: 45, DCS430, DCS43001, DCS4300I, DCS431, DCS460, DCS4600S, DCS500, DCS5000, DCS5030, DCS520, DCS5200I; Oleo-Mac: 850, 938, 940, 941, 942, 942C, 945, 946, 947, 950, 950 Super, 950A, 951, 952, 956, 962 E300F, GS410CX, GS44; Partner: 1200EL, 1400EL, 1450EL, 1500EL, 1650EL, 365, 400, 405, 410, 450, 460, 465, 470, 495, 500, 510, 540, 545, P500, P5000, P5500; Solo: 639, 641, 644, 645, 647, 650, 651, 652, 656, 665

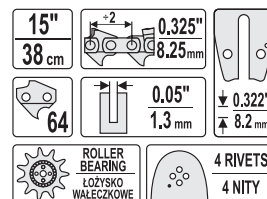

YATO	size / rozmiar	
YT-84933	15" (38 cm)	20



for / dla: YT-84900, YT-84941, YT-84963

competitors / odpowiedniki: Oregon: 158PXBK095; Dolmar: 415038631; Husqvarna: 508912164, 508912364; Makita: 445038631; Solo: 6900343, 6900343K, 6900343N

for / dla: Dolmar: 109, 110, 111, 112, 113, 114, 115, 116, ES1800, PS460, PS4600, PS4605, PS500, PS5000, PS510, PS5100S, PS540; Homelite: 250, 252, 290, 290C, 300, 340, 340C, 3850B, 3850C, 4045, 415B, 444, 4550B, HCS4040, HCS4446CA; Husqvarna: 133, 136, 137, 141, 142, 154, 234, 238, 240, 242, 242XP, 246, 254, 257, 261, 262, 339XP, 340, 345, 346, 346XP, 350, 351, 353, 357, 357XP, 359, 36, 40, 41, 42, 435, 435E, 44, 440, 440E, 444, 445, 445E, 45, 450E, 455 RANCHER, 455E RANCHER, 460, 460 RANCHER, 50, 51, 550, 560XP, T435; Jonsered: 2012, 2014, 2015, 2016, 2036, 2040, 2041, 2045, 2050, 2051, 2054, 2055, 2063, 2141, 2145, 2147, 2149, 2150, 2152, 2153, 2155, 2156, 2159, 2163, 370, 380, 410, 420, 425, 435, 45, 450, 451, 451EVS, 452, 455, 490, 49SP, 50, 51, 510, 52, 520, 521, 525, 535, 590, CS2149W, CS2152W; Makita: 45, DCS430, DCS43001, DCS4300I, DCS431, DCS460, DCS4600S, DCS500, DCS5000, DCS5030, DCS5200I; NAC: NO-CS38, SPS01-45, SPS01-52, SPS02-45, YD 40/45, YD40, YD52; Oleo-Mac: 850, 938, 940, 941, 942, 942C, 945, 946, 947, 950, 950 Super, 950A, 951, 952, 956, 962, E300F; Partner: 365, 400, 405, 410, 450, 460, 465, 470, 495, 500, 510, 540, 545, P500, P5000, P5500

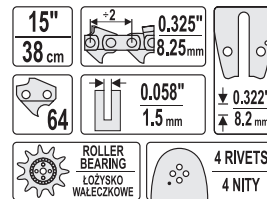

YATO	size / rozmiar	
YT-84934	15" (38 cm)	20



for / dla: YT-84953, YT-84960

competitors / odpowiedniki: Oregon: 160SDEA041; Oleo-Mac: 50050092; Husqvarna: 530044508; Windsor: 16PKU50SSR; Makita: 442040661, 442040061; Alpina: 4112500; Partner: 530044329

for / dla: Al-Ko: 2000, 2300, 25A, E1200, E125, E1400, E1500, KE3500 VARIO, KE4000, KS, KSB; Alpina: 352, 382, A10E, A14E, E120, E130, E150, ELECTRIC ES182, ES202, KS1400B, KS1500B; Dolmar: 100, 101, 102, 103, 104, 105, 106, 108, 275, 285, ES140, ES151, ES152, ES152A, ES153, ES160, ES161, ES162, ES163, ES172, ES172A, ES173, ES183, ES2035, ES2040, ES3, ES30, ES37, ES40, ES41, ES6, PS33, PS330, PS3300TH, PS34, PS340, PS341, PS3410, PS344, PS350, PS390, PS400, PS401, PS41, PS45; Echo: CS2600ES, CS2600TES, CS2700ES, CS310WES, CS3500ES, CS3500WES, CS351WES, CS3600WES; Hitachi: CS280A, CS280B, CS350A, CS350B, CS35B; Homelite: 20AV, 23AV, 27, 3300, 3335, 3350, 3550, 3800, 3850, 4500, 4550, CS40, HCS3335, HCS4041CA, PS33, RANGER, TIMBERMAN, UT10901, UT10926, UT10974; Husqvarna: 23, E16, E316, E317, E321, T425; Jonsered: 2033TH; Makita: 5012, 5014, 5016, BUC122RFE, BUC250RDE, DCS230T, DCS232T, DCS300, DCS300S, DCS330, DCS330S, DCS34, DCS340, DCS341, DCS3410TH, DCS350, DCS3500, DCS3501, DCS3520A, DCS380, DCS390, DCS400, DCS401, DCS4610, UC3000, UC3030A, UC3500, UC3501, UC3520A, UC3530AK, UC4000, UC4030AK; McCulloch: 338, 442; Oleo-Mac: 931, 932, GS35, GS350, GS370, GS410C; Partner: 330, 335, 340, 345, 350, 351, 352, 360, 370, 385, 391, 395, P390, P420, P842; Ryobi: APR02, PCN3335

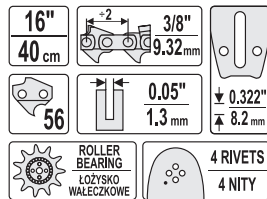

YATO	size / rozmiar	
YT-84935	16" (40 cm)	20



for / dla: YT-84900, YT-84943, YT-84963

competitors / odpowiedniki: Oregon: 188SLGK095; Dolmar: 415045631; Makita: 415045631; Windsor: 18CJL58SPYJ

for / dla: Dolmar: 109, 110, 111, 112, 113, 114, 115, 116, ES1800, PS460, PS4600, PS4605, PS500, PS5000, PS510, PS5100S, PS540; Homelite: 250, 252, 290, 290C, 300, 340, 340C, 3850B, 3850C, 4045, 415B, 444, 4550B, HCS4040, HCS4446CA; Husqvarna: 133, 136, 137, 141, 142, 154, 234, 238, 240, 242, 242XP, 246, 254, 257, 261, 262, 339XP, 340, 345, 346, 346XP, 350, 351, 353, 357, 357XP, 359, 36, 40, 41, 42, 435, 435E, 44, 440, 440E, 444, 445, 445E, 45, 450E, 455 RANCHER, 455E RANCHER, 460, 460 RANCHER, 50, 51, 550, 560XP, T435; Jonsered: 2012, 2014, 2015, 2016, 2036, 2040, 2041, 2045, 2050, 2051, 2054, 2055, 2063, 2141, 2145, 2147, 2149, 2150, 2152, 2153, 2155, 2156, 2159, 2163, 370, 380, 410, 420, 425, 435, 45, 450, 451, 451EVS, 452, 455, 490, 49S, P50, 51, 510, 52, 520, 521, 525, 535, 590, CS2149W, CS2152W; Makita: 45, DCS430, DCS43001, DCS4300I, DCS431, DCS460, DCS4600S, DCS500, DCS5000, DCS5030, DCS520, DCS5200I; NAC: NO-CS38, SPS01-45, SPS01-52, SPS02-45, YD 40/45, YD40, YD52; Oleo-Mac: 850, 938, 940, 941, 942, 942C, 945, 946, 947, 950, 950 Super, 950A, 951, 952, 956, 962, E300F; Partner: 365, 400, 405, 410, 450, 460, 465, 470, 495, 500, 510, 540, 545, P500, P5000, P5500; Solo: 639, 641, 644, 645, 647, 650, 651, 652, 656, 665

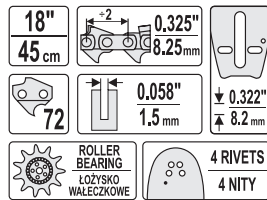

YATO	size / rozmiar	
YT-84936	18" (45 cm)	20

GB Chain for chainsaw
D Kette für Kettensägen
PL Łańcuch tnący do pił
RUS Цепь для бензопилы

CZ Řetěz pro řetězové pily
H Lánc láncfűrész
RO Lanț pt. drujba
F Chaîne de tronçonneuse

I Taglio per motoseghea
E Cadena de motosierra
CN 蠟沫

COLOR BOX
WITH EURO HOLE



for / dla: YT-84900

for / dla: **Alpina:** A40, A40E, P400, P450, P460, P500, P510, P522, PRO540, PRO600, PROF-41, PROF-45; **Dolmar:** 109, 110, 111, 112, 113, 114, 1151, 116, ES1800, PS460, PS4600, PS4605, PS500, PS5000, PS5100S, PS540; **Echo:** CS4200ES, CS4400; **Homelite:** 250, 252, 290, 290C, 300, 340, 340C, 3850B, 3850C, 415B, 444, 4550B, HCS4040, HCS4446CA; **Husqvarna:** 133, 136, 137, 140, 141, 142, 154, 234, 235, 238, 240, 240E, 242, 242XP, 246, 254, 254XP, 257, 261, 262, 338XPT, 339XP, 340, 345, 346, 346XP, 350, 351, 353, 357, 357XP, 359, 36, 365, 40, 41, 42, 435, 435E, 44, 440E, 444, 445, 445E, 45, 450E, 455 RANCHER, 455E RANCHER, 460 RANCHER, 50, 51, 55, T435; **Jonsered:** 2012, 2014, 2015, 2016, 2036, 2040, 2041, 2045, 2050, 2051, 2054, 2055, 063, 2141, 2145, 2147, 2149, 2150, 2152, 2153, 2155, 2156, 2159, 2163, 370, 380, 410, 420, 425, 435, 45, 450, 451, 451EVS, 452, 455, 490, 49SP, 50, 51, 510, 52, 521, 525, 535, 590, CS2149W, CS2152W; **Makita:** 45, DCS430, DCS43001, DCS43001, DCS431, DCS460, DCS4600S, DCS4630, DCS500, DCS5000, DCS5030, DCS520, DCS52001; **NAC:** NO-CS38, SPS01-45, SPS01-52, SPS02-45, YD 40/45, YD40, YD52; **Oléo-Mac:** 850, 938, 940, 941, 942, 945, 946, 947, 950, 950 Super, 950A, 951, 952, 956, 962, E300F; **Partner:** 1650, 365, 400, 405, 410, 450, 460, 465, 470, 495, 500, 510, 525, 535, 590, CS2149W, CS2152W; **Makita:** 45, DCS430, DCS43001, DCS431, DCS460, DCS4600S, DCS4630, DCS500, DCS5000, DCS5030, DCS520, DCS52001; **NAC:** NO-CS38, SPS01-45, SPS01-52, SPS02-45, YD 40/45, YD40, YD52; **Oléo-Mac:** 850, 938, 940, 941, 942, 945, 946, 947, 950, 950 Super, 950A, 951, 952, 956, 962, E300F; **Partner:** 1650, 365, 400, 405, 410, 450, 460, 465, 470, 495, 500, 510, 540, 545, P500, P5000, P5500

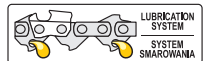
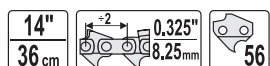

YATO	size / rozmiar	
YT-84940	14" (36 cm)	50



for / dla: YT-84900, YT-84934

for / dla: **Dolmar:** 109, 110, 111, 112, 113, 114, 1151, 116, ES1800, PS460, PS4600, PS4605, PS500, PS5000, PS5510, PS5100S, PS540; **Husqvarna:** 154, 257, 440E, 133, 136, 137, 140, 141, 142, 234, 235, 238, 240, 240E, 242, 242XP, 246, 254, 254XP, 261, 262, 338XPT, 339XP, 340, 345, 346, 346XP, 350, 351, 353, 357, 357XP, 359, 36, 365, 372XP, 40, 41, 42, 435, 435E, 44, 444, 445, 445E, 45, 450E, 455 RANCHER, 455E RANCHER, 460 RANCHER, 50, 51, 55, T435; **Jonsered:** 520, 2012, 2014, 2015, 2016, 2036, 2040, 2041, 2045, 2050, 2051, 2054, 2055, 063, 2141, 2145, 2147, 2149, 2150, 2152, 2153, 2155, 2156, 2159, 2163, 370, 380, 410, 420, 425, 435, 45, 450, 451, 451EVS, 452, 455, 490, 49SP, 50, 51, 510, 52, 521, 525, 535, 590, CS2149W, CS2152W; **Makita:** 45, DCS430, DCS43001, DCS43001, DCS431, DCS460, DCS4600S, DCS4630, DCS500, DCS5000, DCS5030, DCS520, DCS52001; **NAC:** NO-CS38, SPS01-45, SPS01-52, SPS02-45, YD 40/45, YD40, YD52; **Oléo-Mac:** 850, 938, 940, 941, 942, 945, 946, 947, 950, 950 Super, 950A, 951, 952, 956, 962, E300F; **Partner:** 1650, 365, 400, 405, 410, 450, 460, 465, 470, 495, 500, 510, 540, 545, P500, P5000, P5500

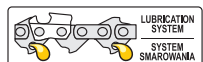
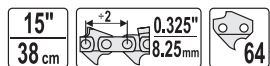

YATO	size / rozmiar	
YT-84941	15" (38 cm)	50



for / dla: YT-84900

for / dla: **Dolmar:** 109, 110, 111, 112, 113, 114, 1151, 116, ES1800, PS460, PS4600, PS4605, PS500, PS5000, PS5510, PS5100S, PS540; **Husqvarna:** 154, 257, 440E, 133, 136, 137, 140, 141, 142, 234, 235, 238, 240, 240E, 242, 242XP, 246, 254, 254XP, 261, 262, 338XPT, 339XP, 340, 345, 346, 346XP, 350, 351, 353, 357, 357XP, 359, 36, 365, 372XP, 40, 41, 42, 435, 435E, 44, 444, 445, 445E, 45, 450E, 455 RANCHER, 455E RANCHER, 460 RANCHER, 50, 51, 55, T435; **Jonsered:** 520, 2012, 2014, 2015, 2016, 2036, 2040, 2041, 2045, 2050, 2051, 2054, 2055, 063, 2141, 2145, 2147, 2149, 2150, 2152, 2153, 2155, 2156, 2159, 2163, 370, 380, 410, 420, 425, 435, 45, 450, 451, 451EVS, 452, 455, 490, 49SP, 50, 51, 510, 52, 521, 525, 535, 590, CS2149W, CS2152W; **Makita:** 45, DCS430, DCS43001, DCS43001, DCS431, DCS460, DCS4600S, DCS4630, DCS500, DCS5000, DCS5030, DCS520, DCS52001; **NAC:** NO-CS38, SPS01-45, SPS01-52, SPS02-45, YD 40/45, YD40, YD52; **Oléo-Mac:** 850, 938, 940, 941, 942, 945, 946, 947, 950, 950 Super, 950A, 951, 952, 956, 962, E300F; **Partner:** 1650, 365, 400, 405, 410, 450, 460, 465, 470, 495, 500, 510, 540, 545, P500, P5000, P5500

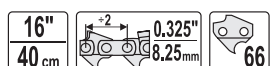

YATO	size / rozmiar	
YT-84942	16" (40 cm)	50



for / dla: YT-84900, YT-84936

for / dla: **Dolmar:** 109, 110, 111, 112, 113, 114, 1151, 116, ES1800, PS460, PS4600, PS4605, PS500, PS5000, PS5510, PS5100S, PS540; **Husqvarna:** 154, 257, 440E, 133, 136, 137, 140, 141, 142, 234, 235, 238, 240, 240E, 242, 242XP, 246, 254, 254XP, 261, 262, 338XPT, 339XP, 340, 345, 346, 346XP, 350, 351, 353, 357, 357XP, 359, 36, 365, 372XP, 40, 41, 42, 435, 435E, 44, 444, 445, 445E, 45, 450E, 455 RANCHER, 455E RANCHER, 460 RANCHER, 50, 51, 55, T435; **Jonsered:** 520, 2012, 2014, 2015, 2016, 2036, 2040, 2041, 2045, 2050, 2051, 2054, 2055, 063, 2141, 2145, 2147, 2149, 2150, 2152, 2153, 2155, 2156, 2159, 2163, 370, 380, 410, 420, 425, 435, 45, 450, 451, 451EVS, 452, 455, 490, 49SP, 50, 51, 510, 52, 521, 525, 535, 590, CS2149W, CS2152W; **Makita:** 45, DCS430, DCS43001, DCS43001, DCS431, DCS460, DCS4600S, DCS4630, DCS500, DCS5000, DCS5030, DCS520, DCS52001; **NAC:** NO-CS38, SPS01-45, SPS01-52, SPS02-45, YD 40/45, YD40, YD52; **Oléo-Mac:** 850, 938, 940, 941, 942, 945, 946, 947, 950, 950 Super, 950A, 951, 952, 956, 962, E300F; **Partner:** 1650, 365, 400, 405, 410, 450, 460, 465, 470, 495, 500, 510, 540, 545, P500, P5000, P5500

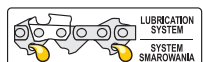
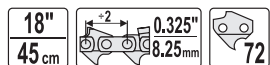

YATO	size / rozmiar	
YT-84943	18" (45 cm)	50



for / dla: YT-84900

for / dla: **Dolmar:** 109, 110, 111, 112, 113, 114, 1151, 116, ES1800, PS460, PS4600, PS4605, PS500, PS5000, PS5510, PS5100S, PS540; **Husqvarna:** 154, 257, 440E, 133, 136, 137, 140, 141, 142, 234, 235, 238, 240, 240E, 242, 242XP, 246, 254, 254XP, 261, 262, 338XPT, 339XP, 340, 345, 346, 346XP, 350, 351, 353, 357, 357XP, 359, 36, 365, 372XP, 40, 41, 42, 435, 435E, 44, 444, 445, 445E, 45, 450E, 455 RANCHER, 455E RANCHER, 460 RANCHER, 50, 51, 55, T435; **Jonsered:** 2012, 2014, 2015, 2016, 2036, 2040, 2041, 2045, 2050, 051, 2054, 2055, 2063, 2141, 2145, 2147, 2149, 2150, 2152, 2153, 2155, 2156, 2159, 2163, 370, 380, 410, 420, 425, 435, 45, 450, 451, 451EVS, 452, 455, 490, 49SP, 50, 51, 510, 52, 520, 521, 525, 535, 590, CS2149W, CS2152W; **Makita:** 45, DCS430, DCS43001, DCS43001, DCS431, DCS460, DCS4600S, DCS4630, DCS500, DCS5000, DCS5030, DCS520, DCS52001; **NAC:** NO-CS38, SPS01-45, SPS01-52, SPS02-45, YD 40/45, YD40, YD52; **Oléo-Mac:** 850, 938, 940, 941, 942, 945, 946, 947, 950, 950 Super, 950A, 951, 952, 956, 962, E300F; **Partner:** 1650, 365, 400, 405, 410, 450, 460, 465, 470, 495, 500, 510, 540, 545, P500, P5000, P5500

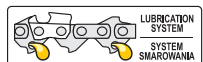
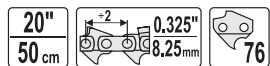

YATO	size / rozmiar	
YT-84944	20" (50 cm)	50



for / dla: YT-84905, YT-84933

for / dla: **Dolmar:** 109, 110, 111, 112, 113, 114, 1151, 116, PS460, PS4600, S4605, PS500, PS5000, PS510, PS5100S, PS540; **Husqvarna:** 133, 136, 137, 141, 142, 154, 234, 238, 240, 242, 42XP, 246, 254, 254XP, 257, 261, 262, 338XPT, 339XP, 340, 345, 346, 346XP, 350, 351, 353, 357, 357XP, 359, 36, 65, 40, 41, 42, 435, 435E, 44, 440E, 444, 445, 445E, 45, 450E, 455 RANCHER, 455E RANCHER, 460, 460 RANCHER, 50, 51, 55, T435; **Jonsered:** 2012, 2014, 2015, 2016, 2036, 2040, 2041, 2045, 2050, 051, 2054, 2055, 2063, 2141, 2145, 2147, 2149, 2150, 2152, 2153, 2155, 2156, 2159, 2163, 370, 380, 410, 420, 425, 435, 45, 450, 451, 451EVS, 452, 455, 490, 49SP, 50, 51, 510, 52, 520, 521, 525, 535, 590, CS2149W, CS2152W; **Makita:** 45, DCS430, DCS43001, DCS43001, DCS431, DCS460, DCS4600S, DCS4630, DCS500, DCS5000, DCS5030, DCS520, DCS52001; **Oléo-Mac:** 850, 938, 940, 941, 941C, 942, 945, 946, 947, 950, 950 Super, 950A, 951, 952, 956, 962, E300F, GS350, GS370, GS410CX; **Partner:** 1200EL, 1400EL, 1450EL, 1500EL, 1650EL, 365, 400, 405, 410, 450, 460, 465, 470, 495, 500, 510, 540, 545, P500, P5000, P5500

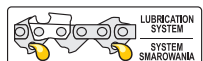
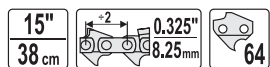

YATO	size / rozmiar	
YT-84945	15" (38 cm)	50

GB Chain for chainsaw
D Kette für Kettensägen
PL Łańcuch tnący do pił
RUS Цепь для бензопилы

CZ Řetěz pro řetězové pily
H Lánc láncfűrész
RO Lanț pt. drujba
F Chaîne de tronçonneuse

I Taglio per motosegna
E Cadena de motosierra
CN 蠟沫

COLOR BOX
WITH EURO HOLE



KICKBACK REDUCTION REDUKCJA ODRZUTU
 VIBRATION REDUCTION REDUKCJA WIBRACJI
Mn 65



14"
36 cm

3/8"
9.32 mm

50

0.05"
1.3 mm

SEMI-CHEL POL-DUTO

for / dla: Alpina: 270, 280, 330, 380, 432, 438, EURO-40, EURO-45, Elletra 160, Elletra 170, Energy 1.6, Energy 1.8, P360, P370, P390, PR350, Sinergy 35, Sinergy 40; Dolmar: CS2040, PS3300TH; Husqvarna: T425; McCulloch: 3500, 370, 374, 375, 384, 400, 400P, 430, 442, 445, 470, 474, 484, 838, 839, ELECTRA MAC 16E, MAC110, MAC120, MAC130, MAC140, MAC4, MAC6, MAC930, MAC935, MC115, MM30, MM36, PM310, PM320, PM330, PM340, PM36, PM360, PM364, PM370, PM380, PM394, PM400, M470, PM480, PM484, PM510, PM730; Oleo-Mac: 240, OEM200; Partner: 1535EL, 1540, 1540EL, 1640, 1835, 1840, 352, 371, 391, 538E, 542E, P1535, P351; Stihl: 009, 010, 011, 012, 017, 018, 019, 019T, 020, 020T, 021, 021C, 023, 025, 25, MS160, MS170, MS180, MS181, MS191, MS192, MS200, MS200T, MS210, MS211, MS230, MS231, MS241, MS250, MS251, MSE140, MSE200

YATO size / rozmiar
YT-84950 14" (36 cm) 50

for / dla: YT-84931



for / dla: Al-Ko: 2000, 2300, 25A, E1200, E125, E1400, E1500, KE3500 VARIO, KE4000, KS, KSB; Alpina: 352, 382, A10E, A14E, E120, E130, E150, ELECTRIC, ES182, ES202, KS1400B, KS1500B; Dolmar: 100, 101, 102, 103, 104, 105, 106, 108, 275, 285, CS2040E, S140, ES151, ES152, ES152A, ES153, ES160, ES161, ES162, ES162A, ES163, ES172, ES172A, ES173, ES183, ES2035, ES2040, ES3, ES30, ES37, ES40, ES41, ES6, PS33, PS330, PS3300TH, PS330TH, PS34, PS340, PS341, PS3410, PS344, PS350, PS390, PS400, PS401, PS41, PS45; Echo: CS2600ES, CS260TES, CS2700ES, CS3500ES, CS3500WES, CS3510WES; Hitachi: CS280A, CS280B, CS350A, CS350B, CS35B; Homelite: 20AV, 23AV, 27, 3300, 3335, 3350, 3550, 3800, 4500, 4550, CS40, HCS3335, HCS4041CA, PS33, RANGER, TIMBERMAN, UT10901, UT10926, UT10974; Husqvarna: 136, 137, 1400, 141, 142, 16, 1600, 23, 243, 315, 316, 318, 320, 321, 33, 333, 334, 335XPT, 338, 338XPT, 36, 41, E16, E316, E317, E321, T425; Jonsered: 2033TH, 2035, 2115, 2115EL, 2116, 2117, 2118EL, 2121, 2135, 2137, 2138, 2139; Makita: 5012, 5016, BUC122RFE, BUC250RDE, DCS230T, DCS232T, DCS300, DCS300S, CS330, DCS330S, DCS34, DCS340, DCS341, DCS3410TH, DCS350, DCS3500, DCS3501, DCS3520A, DCS380, DCS390, DCS400, DCS401, DCS4610, UC3000, UC3030A, UC3500, UC3501, UC3520A, UC3530AK, UC4000, UC4030AK; McCulloch: MS1215, MS1415, MS1425, MS1435, MS1630, MS1635AV, MS1640, MS1645, MS1834N, MS1845J; Oleo-Mac: 931, 932, GS35, GS350, GS370; Partner: 330, 335, 340, 345, 350, 351, 360, 370, 385, 391, 395, P390, P420, P842; Ryobi: APR02, PCN33351

14"
36 cm

3/8"
9.32 mm

52

0.05"
1.3 mm

SEMI-CHEL POL-DUTO

YATO size / rozmiar
YT-84951 14" (36 cm) 50

for / dla: YT-84935



for / dla: Al-Ko: 2000, 2300, 25A, E1200, E125, E1400, E1500, KE3500 VARIO, KE4000, KS, KSB; Alpina: 352, 382, A10E, A14E, E120, E130, E150, ELECTRIC, ES182, ES202, KS1400B, KS1500B; Dolmar: 100, 101, 102, 103, 104, 105, 106, 108, 275, 285, CS2040, ES140, ES151, ES152, ES152A, ES153, ES160, ES161, ES162, ES162A, ES163, ES172, ES172A, ES173, ES183, ES2035, ES2040, ES3, ES30, ES37, ES40, ES41, ES6, PS33, PS330, PS3300TH, PS330TH, PS34, PS340, PS341, PS3410, PS344, PS350, PS390, PS400, PS401, PS41, PS45; Echo: CS2600ES, CS260TES, CS2700ES, CS3500ES, CS3500WES, CS3510WES; Hitachi: CS280A, CS280B, CS350A, CS350B, CS35B; Homelite: 20AV, 23AV, 27, 3300, 3335, 3350, 3550, 3800, 4500, 4550, CS40, HCS3335, HCS4041CA, PS33, RANGER, TIMBERMAN, UT10901, UT10926, UT10974; Husqvarna: 136, 137, 1400, 141, 142, 16, 1600, 23, 243, 315, 316, 318, 320, 321, 33, 333, 334, 335XPT, 338, 338XPT, 36, 41, E16, E316, E317, E321, T425; Jonsered: 2033TH, 2035, 2115, 2115EL, 2116, 2117, 2118EL, 2121, 2135, 2137, 2138, 2139; Makita: 5012, 5016, BUC122RFE, BUC250RDE, DCS230T, DCS232T, DCS300, DCS300S, DCS34, DCS340, DCS341, DCS3410TH, DCS350, DCS3500, DCS3501, DCS3520A, DCS380, DCS390, DCS400, DCS401, DCS4610, UC3000, UC3030A, UC3500, UC3501, UC3520A, UC3530AK, UC4000, UC4030AK; McCulloch: MS1215, MS1415, MS1425, MS1435, MS1630, MS1635AV, MS1640, MS1645, MS1834N, MS1845J; Oleo-Mac: 931, 932, GS35, GS350, GS370; Partner: 330, 335, 340, 345, 350, 351, 360, 370, 385, 391, 395, P390, P420, P842; Ryobi: APR02, PCN3335

16"
40 cm

3/8"
9.32 mm

56

0.05"
1.3 mm

SEMI-CHEL POL-DUTO

YATO size / rozmiar
YT-84953 16" (40 cm) 50

for / dla: YT-84935



for / dla: Al-Ko: 2000, 2300, 25A, E1200, E125, E1400, E1500, KE3500 VARIO, KE4000, KS, KSB; Alpina: 352, 382, A10E, A14E, E120, E130, E150, ELECTRIC, ES182, ES202, KS1400B, KS1500B; Dolmar: 100, 101, 102, 103, 104, 105, 106, 108, 275, 285, CS2040, ES140, ES151, ES152, ES152A, ES153, ES160, ES161, ES162, ES162A, ES163, ES172, ES172A, ES173, ES183, ES2035, ES2040, ES3, ES30, ES37, ES40, ES41, ES6, PS33, PS330, PS3300TH, PS330TH, PS34, PS340, PS341, PS3410, PS344, PS350, PS390, PS400, PS401, PS41, PS45; Echo: CS2600ES, CS260TES, CS2700ES, CS3500ES, CS3500WES, CS3510WES; Hitachi: CS280A, CS280B, CS350A, CS350B, CS35B; Homelite: 20AV, 23AV, 27, 3300, 3335, 3350, 3550, 3800, 4500, 4550, CS40, HCS3335, HCS4041CA, PS33, RANGER, TIMBERMAN, UT10901, UT10926, UT10974; Husqvarna: 23, E16, E316, E317, E321, T425; Jonsered: 2033TH; Makita: 5012, 5016, BUC122RFE, BUC250RDE, DCS230T, DCS232T, DCS300, DCS300S, DCS330, DCS330S, DCS34, DCS340, DCS341, DCS3410TH, DCS350, DCS3500, DCS3501, DCS3520A, DCS380, DCS390, DCS400, DCS401, DCS4610, UC3000, UC3030A, UC3500, UC3501, UC3520A, UC3530AK, UC4000, UC4030AK; Oleo-Mac: 931, 932, GS35, GS350, GS370; Partner: 330, 335, 340, 345, 350, 351, 360, 370, 385, 391, 395, P390, P420; Ryobi: APR02, PCN3335

16"
40 cm

3/8"
9.32 mm

57

0.05"
1.3 mm

SEMI-CHEL POL-DUTO

YATO size / rozmiar
YT-84954 16" (40 cm) 50

for / dla: Stihl: 029, 031, 032, 034, 036, 038, 039, 041, 042, 044, 045, 046, 048, 056, 064, 066, E15, E20, E220, MS200, MS220, MS290, MS310, MS311, MS340, MS341, MS361, MS362, MS390, MS440, MS441, MS460, MS650, MS660, MS880, MSE200, MSE220

16"
40 cm

3/8"
9.32 mm

60

0.063"
1.6 mm

CHEL DLUTO

LUBRICATION SYSTEM SYSTEM SMAROWANA

YATO size / rozmiar
YT-84955 16" (40 cm) 50

GB Chain for chainsaw
D Kette für Kettensägen
PL Łańcuch tnący do pił
RUS Цепь для бензопилы

CZ Řetěz pro řetězové pily
H Lánc láncfűrész
RO Lanț pt. drujba
F Chaîne de tronçonneuse

I Taglio per motosegna
E Cadena de motosierra
CN 蠟沫

PAPER SPOOL & COLOR LABEL
PLUS 30 PCS OF ADDITIONAL
COLOR BOXES & POLYBAGS



KICKBACK REDUCTION REDUKCJA ODRZUTU
 VIBRATION REDUCTION REDUKCJA WIBRACJI
1632

Mn 65
 30 SPARE LINKS ZAPASOWYCH OGNIV
 SEMI-CHEL POL-DUTO

3/8"
9.32 mm

0.05"
1.3 mm

for / dla: YT-84930, YT-84931, YT-84935

for / dla: Alpina: 270, 280, 330, 380, 432, 438, EURO-40, EURO-45, Elletra 160, Elletra 170, Energy 1.6, Energy 1.8, P360, P370, P390, PR350, Sinergy 35, Sinergy 40; Dolmar: CS2040, PS3300TH; Husqvarna: T425; McCulloch: 3500, 370, 374, 375, 384, 400, 400P, 430, 442, 445, 470, 474, 484, 838, 839, ELECTRA MAC 16E, MAC110, MAC120, MAC130, MAC140, MAC4, MAC6, MAC930, MAC935, MC115, MM30, MM36, PM310, PM320, PM330, PM340, PM36, PM360, PM364, PM370, PM380, PM394, PM400, M470, PM480, PM484, PM510, PM730; Oleo-Mac: 240, OEM200; Partner: 1535EL, 1540, 1540EL, 1640, 1835, 1840, 352, 371, 391, 538E, 542E, P1535, P351; Stihl: 009, 010, 011, 012, 017, 018, 019, 019T, 020, 020T, 021, 021C, 023, 025, 25, MS160, MS170, MS180, MS181, MS191, MS192, MS200, MS200T, MS210, MS211, MS230, MS231, MS241, MS250, MS251, MSE140, MSE200



YATO size / rozmiar
YT-84960 1

GB Chain for chainsaw
D Kette für Kettensägen
PL Łańcuch łańcucha do pił
RUS Цепь для бензопилы

CZ Řetěz pro řetězové pily
H Lánc láncfűrészt
RO Lant pt. drujba
F Chaîne de tronçonneuse

I Taglio per motosegna
E Cadena de motosierra
CN 鋸沫

PAPER SPOOL & COLOR LABEL
PLUS 30 PCS OF ADDITIONAL
COLOR BOXES & POLYBAGS



+30 PCS



KICKBACK
REDUCTION
ODRZUTU

VIBRATION
REDUCTION
REDUKCJA
WIBRACJI

Mn
65

30
SPARE LINKS
ZAPASOWYCH
OŁNIV

for / dla: YT-84932

for / dla: **Alpina:** P700, P750, P800, PROF700, PROF800; **Dolmar:** 115, 117, 119, 120, 120SI, 122, 123, 1231, 133, 143, 152, 153, 186, 219, CA, KMS4, PS43, PS6000I, PS6000IH, PS6400, PS6400H, PS6800I, PS6800IH, PS7300, PS7300H, PS7900, PS7900H, PS9000, PS9010; **Echo:** CS3500, CS3500WES, CS351WE; **Husqvarna:** 1100, 154, 160, 162, 181, 2100XP, 2101, 2101XP, 254, 257, 260, 261, 262, 266, 268, 272, 281XP, 285, 288XP, 298, 298X, 298XG, 3120, 3120XP, 357, 357XP, 359, 362, K34365, 371, 371XP, 371XPG, 372, 372XP, 372XPG, 380, 385, 385XP, 394, 394XP, 394XPG, 395, 395XP, 395XPG, 455, 480, 55, 560XP, 562XP, 570, 575, 575XP, 576XP, 61, 64, 65, 66, 70, 77; **Jonsered:** 1020, 2063, 2065, 2071, 2077, 2083, 2094, 2095, 2159, 2163, 2165, 2171, 2186, 625, 630, 630 SUPER, 670, 670 CHAMP, 820; **Makita:** DCS460, DCS4600, DCS500, DCS5030, DCS6400, DCS6401, DCS7301, DCS79001, DCS9000, DCS9010; **Oleo-Mac:** 250A, 251, 252, 254, 261, 264, 271, 272, 284, 350, 355, 460, 480, 481, 482, 484, 970, 971, 980, 981, E300; **Partner:** 550, 660, 710, P770



1632

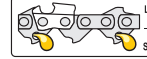

LUBRICATION
SYSTEM
SYSTEM
SMAROWANIA

YATO 
YT-84961 1

for / dla: YT-84905, YT-84933

for / dla: **Dolmar:** 109, 110, 111, 112, 113, 114, 115I, 116, PS460, PS4600, S4605, PS500, PS5000, PS5100, PS5100S, PS540; **Husqvarna:** 133, 136, 137, 141, 142, 154, 234, 238, 240, 242, 42XP, 246, 254, 254XP, 257, 261, 262, 338XPT, 339XP, 340, 345, 346, 346XP, 350, 351, 353, 357, 357XP, 359, 36, 65, 40, 41, 42, 435, 435E, 44, 440E, 444, 445, 445E, 45, 450E, 455 RANCHER, 455E RANCHER, 460, 460 RANCHER, 50, 51, 55, 1435; **Jonsered:** 2012, 2014, 2015, 2016, 2036, 2040, 2041, 2045, 2050, 051, 2054, 2055, 2063, 2141, 2145, 2147, 2149, 2150, 2152, 2153, 2155, 2156, 2159, 2163, 370, 380, 410, 420, 425, 435, 45, 450, 451, 451EVS, 452, 455, 490, 495P, 50, 51, 510, 52, 520, 521, 525, 535, 590, CS2149W, CS2152W; **Makita:** 45, DCS4300, DCS4300I, DCS4300I, DCS431, DCS460, DCS4600S, DCS4630, DCS500, DCS5000, DCS5030, DCS520, DCS5200I; **Oleo-Mac:** 850, 938, 940, 941, 941C, 942, 945, 946, 947, 950, 950 Super, 950A, 951, 952, 956, 962, E300F, GS350, GS370, GS410CX; **Partner:** 1200EL, 1400EL, 1450EL, 1500EL, 1650EL, 365, 400, 405, 410, 450, 460, 465, 470, 495, 500, 510, 540, 545, P500, P5000, P5500



1846

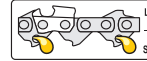

LUBRICATION
SYSTEM
SYSTEM
SMAROWANIA

YATO 
YT-84962 1

for / dla: YT-84900, YT-84934, YT-84936

for / dla: **Dolmar:** 109, 110, 111, 112, 113, 114, 115I, 116, ES1800, PS460, PS4600, PS4605, PS500, PS5000, PS5110, PS5100S, PS540; **Husqvarna:** 154, 257, 440e, 133, 136, 137, 140, 141, 142, 234, 235, 238, 240, 240e, 242, 242XP, 246, 254, 254XP, 261, 262, 338XPT, 339XP, 340, 345, 346, 346XP, 350, 351, 353, 357, 357XP, 359, 36, 365, 372XP, 40, 41, 42, 435, 435E, 44, 444, 445, 445E, 45, 450E, 455 RANCHER, 455E RANCHER, 460 RANCHER, 50, 51, 55, 1435; **Jonsered:** 520, 2012, 2014, 2015, 2016, 2036, 2040, 2041, 2045, 2050, 2051, 2054, 2055, 063, 2141, 2145, 2147, 2149, 2150, 2152, 2153, 2155, 2156, 2159, 2163, 370, 380, 410, 420, 425, 435, 45, 450, 451, 451EVS, 452, 455, 490, 495P, 50, 51, 510, 52, 521, 525, 535, 590, CS2149W, CS2152W; **Makita:** 45, DCS430, DCS4300I, DCS4300I, DCS431, DCS460, DCS4600S, DCS4630, DCS500, DCS5000, DCS5030, DCS520, DCS5200I; **NAC:** NO-CS38, SPS01-45, SPS01-52, SPS02-45, YD 40/45, YD40, YD52; **Oleo-Mac:** 850, 938, 940, 941, 942, 945, 946, 947, 950, 950 Super, 950A, 951, 952, 956, 962, E300F; **Partner:** 1650, 365, 400, 405, 410, 450, 460, 465, 470, 495, 500, 510, 540, 545, P500, P5000, P5500



1846



LUBRICATION
SYSTEM
SYSTEM
SMAROWANIA

YATO 
YT-84963 1

GB Chainsaw chain spinner
D Sägekette nettergät
PL Nitownica do łańcuchów do pilarek
RUS Станок для клепания цепей
CZ Nitovačka pilových řetězů
H Szegezselő készülék fűrészláncokhoz
RO Masina de nituit lanturi si de spart lanturi
F Riveteuse d'établi pour chaînes de tronçonneuses
I Catena spinner
E Remachadora banco cadenas de motosierra
CN 鋸鏈

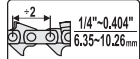
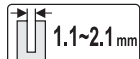
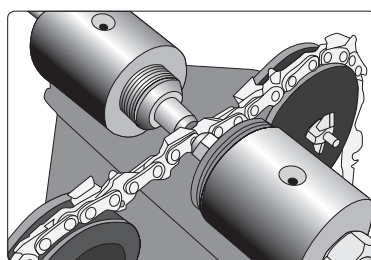
COLOR
BOX



YATO 
YT-84970 6









GB Chainsaw chain breaker
D Sägeketten Entnetgerät
PL Rozkuwarka do łańcuchów pilarek
RUS Станок для расклепки цепей
CZ Roznitovačka pilových řetězů
H Szegezskinyomó fűrészláncokhoz
RO Masina spart lant drujba
F Deriveteuse chaine de tronçonneuse
I Catena breaker
E Rompe cadenas de motosierra
CN 鋸鏈













COLOR
BOX



YATO 
YT-84971 6

YATO 	page/ strona	YATO 	page/ strona	YATO 	page/ strona	YATO 	page/ strona	YATO 	page/ strona	YATO 	page/ strona	YATO 	page/ strona	YATO 	page/ strona	YATO 	page/ strona
YT-0006	7	YT-0122	10	YT-0213	12	YT-0338	6	YT-04052	81	YT-04354	56	YT-04762	82	YT-05226	52	YT-05516	88
YT-0007	7	YT-0123	10	YT-0215	12	YT-0339	6	YT-0406	81	YT-04355	56	YT-0477	83	YT-05227	52	YT-05517	88
YT-0008	7	YT-0125	10	YT-0217	12	YT-0340	6	YT-0407	81	YT-04356	56	YT-04772	82	YT-05228	52	YT-05518	88
YT-0009	7	YT-0127	10	YT-0219	12	YT-0341	6	YT-0408	81	YT-04357	56	YT-0478	83	YT-0530	15	YT-05519	88
YT-0010	7	YT-0128	10	YT-0222	12	YT-0342	6	YT-0409	81	YT-04360	56	YT-04782	82	YT-0534	326	YT-05520	88
YT-0011	7	YT-0132	10	YT-0223	12	YT-0343	6	YT-0410	85	YT-04370	55	YT-0479	83	YT-0539	313	YT-05521	88
YT-0012	7	YT-0135	14	YT-0227	12	YT-0344	6	YT-0411	85	YT-04371	55	YT-04792	82	YT-0540	313	YT-05522	88
YT-0013	7	YT-0136	14	YT-0228	12	YT-0345	6	YT-0412	85	YT-04372	55	YT-0480	83	YT-05430	88	YT-05571	87
YT-0014	7	YT-0137	14	YT-0232	12	YT-0346	6	YT-0413	85	YT-04373	55	YT-0481	83	YT-05431	88	YT-05572	87
YT-0015	7	YT-0138	14	YT-02330	11	YT-0347	6	YT-0414	85	YT-04374	55	YT-04812	82	YT-05432	88	YT-05574	87
YT-0016	7	YT-01385	14	YT-02331	11	YT-0348	6	YT-0415	85	YT-04375	55	YT-0482	83	YT-05433	88	YT-05576	87
YT-0017	7	YT-0139	14	YT-02332	11	YT-0349	6	YT-0416	85	YT-04381	55	YT-04822	82	YT-05434	88	YT-05577	87
YT-0018	7	YT-0140	14	YT-02333	11	YT-0350	6	YT-0417	85	YT-04382	55	YT-0483	83	YT-05435	88	YT-05578	87
YT-0019	7	YT-0143	14	YT-02334	11	YT-0351	6	YT-0418	85	YT-04383	55	YT-04832	82	YT-05436	88	YT-05579	87
YT-0020	7	YT-0150	10	YT-0248	12	YT-0352	6	YT-0419	85	YT-04384	55	YT-0484	84	YT-05437	88	YT-05581	87
YT-0021	7	YT-0152	10	YT-0250	12	YT-0353	6	YT-0420	85	YT-04385	55	YT-0485	81	YT-05438	88	YT-05583	87
YT-0022	7	YT-01670	18	YT-0252	12	YT-0354	6	YT-0421	323	YT-04386	55	YT-0486	81	YT-05439	88	YT-05585	87
YT-0023	7	YT-01671	18	YT-0290	25	YT-0355	6	YT-04211	323	YT-04387	55	YT-0487	81	YT-05440	88	YT-05586	87
YT-0024	7	YT-01672	18	YT-0291	30	YT-0356	6	YT-04301	55	YT-04388	55	YT-0488	84	YT-05441	88	YT-05588	87
YT-0025	7	YT-01673	18	YT-0292	35	YT-0357	6	YT-04302	55	YT-04390	56	YT-0489	84	YT-05442	88	YT-05590	87
YT-0026	7	YT-01674	18	YT-0293	25	YT-0358	6	YT-04303	55	YT-04391	56	YT-0490	84	YT-05443	88	YT-05591	87
YT-0027	7	YT-01675	18	YT-0294	30	YT-0359	6	YT-04304	55	YT-04392	56	YT-0491	84	YT-05444	88	YT-05592	87
YT-0028	7	YT-01676	18	YT-0295	35	YT-0360	6	YT-04305	55	YT-04393	56	YT-0492	84	YT-05445	88	YT-05593	87
YT-0030	7	YT-01677	18	YT-0297	26	YT-0362	6	YT-04306	55	YT-04394	56	YT-0493	84	YT-05446	88	YT-05594	87
YT-0032	7	YT-01678	18	YT-0298	31	YT-0363	6	YT-04307	55	YT-04395	56	YT-0494	84	YT-05450	88	YT-05597	87
YT-0036	7	YT-01679	18	YT-0299	36	YT-0365	6	YT-04310	55	YT-04396	56	YT-0495	84	YT-05451	88	YT-0560	90
YT-0038	7	YT-0170	14	YT-0307	25	YT-0367	10	YT-04311	55	YT-04397	56	YT-0496	84	YT-05452	88	YT-05601	87
YT-0041	7	YT-0171	14	YT-0308	29	YT-0368	10	YT-04312	55	YT-04398	56	YT-0497	84	YT-05453	88	YT-05602	87
YT-0046	7	YT-0172	14	YT-0309	35	YT-0369	10	YT-04313	55	YT-04401	56	YT-0498	84	YT-05454	88	YT-05603	87
YT-0050	7	YT-0173	14	YT-0310	25	YT-0370	10	YT-04314	55	YT-04411	55	YT-0499	84	YT-05455	88	YT-05604	87
YT-0055	7	YT-0175	14	YT-0311	29	YT-0371	10	YT-04315	55	YT-04412	55	YT-0500	89	YT-05456	88	YT-05605	87
YT-0060	7	YT-0189	8	YT-0312	35	YT-0372	10	YT-04316	55	YT-04413	55	YT-0501	89	YT-05457	88	YT-05606	87
YT-0062	7	YT-0190	14	YT-0313	25	YT-0373	10	YT-04317	55	YT-04417	55	YT-0502	89	YT-05458	88	YT-05607	87
YT-0065	7	YT-01906	8	YT-0314	29	YT-0374	10	YT-04318	55	YT-04418	55	YT-0503	90	YT-05459	88	YT-05608	87
YT-0067	7	YT-01907	8	YT-0315	35	YT-0375	10	YT-04319	55	YT-0459	84	YT-0504	90	YT-05460	88	YT-05609	87
YT-0075	7	YT-01908	8	YT-0316	25	YT-0376	10	YT-04320	56	YT-0461	57	YT-0505	89	YT-05461	88	YT-0561	90
YT-00760	6	YT-01909	8	YT-0317	30	YT-0377	10	YT-04321	56	YT-0465	86	YT-0506	89	YT-05462	88	YT-05610	87
YT-00761	6	YT-0191	8	YT-0318	35	YT-0378	10	YT-04322	56	YT-0466	86	YT-0507	89	YT-05463	88	YT-05611	87
YT-00762	6	YT-0192	8	YT-0319	25	YT-0380	10	YT-04323	56	YT-0467	86	YT-0508	89	YT-05464	88	YT-05615	87
YT-00763	6	YT-0193	8	YT-0320	30	YT-0381	10	YT-04324	56	YT-0468	86	YT-0509	89	YT-05465	88	YT-0562	90
YT-00764	6	YT-0194	8	YT-0321	35	YT-0383	11	YT-04325	56	YT-04681	86	YT-0511	90	YT-05466	88	YT-0563	90
YT-00765	6	YT-0195	8	YT-0322	25	YT-0384	11	YT-04326	56	YT-04682	86	YT-0512	90	YT-05490	88	YT-0585	302
YT-00766	6	YT-0196	8	YT-0323	30	YT-0385	11	YT-04327	56	YT-04685	86	YT-05123	88	YT-05491	88	YT-0590	301
YT-00767	6	YT-0197	8	YT-0324	35	YT-0386	11	YT-04328	56	YT-04686	86	YT-0519	90	YT-05492	88	YT-0591	301
YT-00768	6	YT-0198	8	YT-0325	25	YT-0387	11	YT-04329	56	YT-04690	86	YT-0520	52	YT-05493	88	YT-0593	70; 326
YT-00769	6	YT-0199	8	YT-0326	30	YT-0388	11	YT-04331	56	YT-0470	83	YT-0521	52	YT-05494	88	YT-0594	291
YT-0107	10	YT-0200	8	YT-0327	35	YT-0389	11	YT-04332	56	YT-04702	82	YT-05211	52	YT-05495	88	YT-0595	291
YT-0109	10	YT-0201	8	YT-0331	26	YT-0390	11	YT-04341	55	YT-0471	83	YT-05212	52	YT-05496	88	YT-0596	292
YT-0110	10	YT-0202	8	YT-03311	26	YT-0391	11	YT-04342	55	YT-04712	82	YT-05213	52	YT-05497	88	YT-0598	292
YT-0111	10	YT-0203	8	YT-03315	36; 200	YT-0392	11	YT-04343	55	YT-0472	83	YT-05214	52	YT-05498	88	YT-0599	292
YT-0112	10	YT-0204	8	YT-03316	36; 200	YT-0394	11	YT-04344	55	YT-04722	82	YT-05215	52	YT-05499	88	YT-0600	292
YT-0113	10	YT-0205	8	YT-0332	10	YT-0396	11	YT-04345	55	YT-0473	83	YT-05220	52	YT-05501	88	YT-0601	314
YT-0115	10	YT-0206	8	YT-0333	10	YT-0398	11	YT-04346	55	YT-0474	83	YT-05221	52	YT-05502	88	YT-06011	314
YT-0117	10	YT-0207	12	YT-0334	10	YT-0400	85	YT-04350	56	YT-04742	82	YT-05222	52	YT-05503	88	YT-06012	315
YT-0118	10	YT-0208	9	YT-0335	6	YT-0404	81	YT-04351	56	YT-0475	83	YT-05223	52	YT-05513	88	YT-06013	316
YT-0119	10	YT-0209	12	YT-0336	6	YT-0405	81	YT-04352	56	YT-04752	82	YT-05224	52	YT-05514	88	YT-06014	315
YT-0120	10	YT-0211	12	YT-0337	6	YT-04051	81	YT-04353	56	YT-0476	83	YT-05225	52	YT-05515	88	YT-06015	317















YATO	page/ strona	YATO	page/ strona	YATO	page/ strona	YATO	page/ strona	YATO	page/ strona	YATO	page/ strona	YATO	page/ strona	YATO	page/ strona
YT-06016	316	YT-0657	309	YT-0691	296	YT-07711	69	YT-0838	305	YT-0886	289	YT-09702	259	YT-1040	60
YT-06017	317	YT-0659	307	YT-06912	296	YT-07712	68	YT-08385	305	YT-08920	279	YT-09715	258	YT-1041	60
YT-06019	314	YT-06590	307	YT-06913	296	YT-07720	68	YT-0840	325	YT-08921	286	YT-09740	257	YT-1042	60
YT-0602	298	YT-0660	334	YT-06914	296	YT-07721	68	YT-08403	325	YT-08922	286	YT-09741	257	YT-1043	60
YT-0603	301	YT-0661	335	YT-0692	346	YT-07722	68	YT-0841	306	YT-09000	278	YT-09742	257	YT-1044	60
YT-0605	331	YT-06611	335	YT-0693	346	YT-07723	68	YT-0842	306	YT-09002	277	YT-09743	192; 257	YT-1045	60
YT-0606	309	YT-0662	335	YT-0694	346	YT-07730	69	YT-0843	76	YT-09003	277	YT-09744	192; 257	YT-1046	60
YT-0607	309	YT-0663	334	YT-0695	346	YT-07731	69	YT-0844	307	YT-09008	279	YT-09745	192; 257	YT-1047	60
YT-0608	309	YT-0670	321	YT-0696	346	YT-07732	69	YT-0845	308	YT-0902	278	YT-09746	192; 257	YT-1048	60
YT-0609	298	YT-0671	329	YT-0697	346	YT-07733	69	YT-0846	308	YT-09061	279	YT-09747	192; 257	YT-1049	60
YT-0610	327	YT-0672	324	YT-06980	345	YT-07740	69	YT-0847	307	YT-0907	287	YT-09748	192; 257	YT-1050	60
YT-0611	328	YT-06722	352	YT-06983	345	YT-07741	69	YT-08502	337; 445	YT-09071	287	YT-09749	192; 257	YT-1052	60
YT-0612	303	YT-0673	325	YT-06985	345	YT-07742	69	YT-08503	341; 448	YT-09072	287	YT-09750	192; 257	YT-1054	61
YT-06122	302	YT-0674	325	YT-0699	346	YT-07743	69	YT-08504	339; 446	YT-0908	287	YT-0980	256	YT-1055	61
YT-0613	303	YT-0677	312	YT-0700	293	YT-07744	69	YT-08505	339; 447	YT-0910	287	YT-0981	256	YT-1056	333
YT-0614	303	YT-06771	359	YT-0701	293	YT-07750	69	YT-08507	339; 446	YT-09101	207; 288	YT-0982	256	YT-1060	61
YT-0615	303	YT-06772	356	YT-0704	294	YT-07751	69	YT-08508	338; 446	YT-09102	207; 288	YT-0990	259	YT-1061	61
YT-06155	303	YT-06773	356	YT-07041	294	YT-07752	69	YT-08509	337; 445	YT-09107	207; 288	YT-0993	258	YT-1062	61
YT-06157	303	YT-06774	356	YT-07042	293	YT-07753	69	YT-08513	340; 447	YT-09108	207; 288	YT-0994	258	YT-1064	61
YT-0616	304	YT-06775	356	YT-07043	293	YT-07760	68	YT-08514	340; 448	YT-0911	287	YT-09944	258	YT-1065	64
YT-06160	303	YT-06776	357	YT-0705	293	YT-07761	68	YT-08518	337; 445	YT-0913	277	YT-09945	258	YT-1066	64
YT-0617	318	YT-06777	364	YT-07055	264; 294	YT-07762	68	YT-0852	340; 447	YT-0914	277	YT-1000	60	YT-1067	61
YT-06175	318	YT-06780	358	YT-07061	295	YT-0781	70	YT-08523	339; 447	YT-09152	276	YT-1001	60	YT-1068	64
YT-0618	318	YT-06782	362	YT-07063	295	YT-0782	70	YT-08530	341; 448	YT-09155	276	YT-1002	60	YT-1069	64
YT-0619	332	YT-06785	364	YT-07067	264; 295	YT-07822	70	YT-08531	340; 448	YT-0920	216; 265	YT-1003	60	YT-1070	61
YT-0620	302	YT-06786	359	YT-0707	294	YT-0795	333	YT-08532	341; 449	YT-0921	217; 265	YT-1004	60	YT-1071	61
YT-06205	310	YT-06787	362	YT-0708	295	YT-0796	333	YT-08533	341; 448	YT-0923	217; 265	YT-1005	60	YT-1072	61
YT-0621	332	YT-06790	363	YT-0709	295	YT-0800	333	YT-08563	337; 446	YT-0930	217	YT-1006	60	YT-1073	61
YT-0622	320	YT-0680	327	YT-0710	295	YT-0801	333	YT-08564	342; 449	YT-0931	217	YT-1007	60	YT-1074	61
YT-0623	302	YT-0681	328	YT-07115	296	YT-0802	333	YT-08565	342; 449	YT-0932	217	YT-1008	60	YT-1075	61
YT-0624	302	YT-0682	329	YT-0712	296	YT-0803	334	YT-08566	342; 449	YT-0935	217	YT-1009	60	YT-1076	61
YT-06251	302	YT-06822	330	YT-0715	296	YT-08035	334	YT-08567	342; 449	YT-0936	217	YT-1010	60	YT-1077	61
YT-0627	313	YT-0683	327	YT-0716	346	YT-0807	334	YT-08568	342; 449	YT-0937	217	YT-1011	60	YT-1078	61
YT-06273	313	YT-0684	327	YT-0717	346	YT-0808	334	YT-08569	342; 450	YT-0938	217	YT-1012	60	YT-1079	61
YT-0628	332	YT-0685	327	YT-0718	346	YT-0809	334	YT-08570	343; 450	YT-0939	217	YT-1013	60	YT-1080	61
YT-06288	308	YT-0686	327	YT-0720	26	YT-0810	334	YT-08571	343; 450	YT-0940	217	YT-1014	60	YT-1082	61
YT-0630	309	YT-06864	358	YT-0722	36	YT-0811	334	YT-08572	343; 450	YT-0941	217	YT-1015	60	YT-1083	61
YT-06311	327	YT-06865	357	YT-0730	26	YT-0813	326	YT-08575	342; 450	YT-0942	217	YT-1016	60	YT-1084	61
YT-0632	314	YT-06866	126; 366	YT-0731	30	YT-0814	326	YT-08577	342; 450	YT-09505	252	YT-1017	60	YT-1085	61
YT-0633	316	YT-06868	126; 366	YT-0732	36	YT-0817	326	YT-08581	449	YT-09511	252	YT-1018	60	YT-1086	61
YT-0635	314	YT-06870	126; 366	YT-0733	26	YT-0818	326	YT-08590	343; 450	YT-09512	252	YT-1019	60	YT-1088	61
YT-0636	314	YT-06871	357	YT-0734	31	YT-0819	326	YT-08591	343; 450	YT-09513	252	YT-1020	60	YT-1091	61
YT-0637	314	YT-06872	358	YT-0735	36	YT-08195	176; 318	YT-0860	335	YT-09524	253	YT-1022	60	YT-1092	61
YT-0638	304	YT-06873	361	YT-0750	68	YT-0820	290	YT-0862	142; 374	YT-09525	253	YT-1025	60	YT-1093	61
YT-0640	299	YT-06875	360	YT-07500	68	YT-0821	290	YT-0863	142; 374	YT-0953	253	YT-1027	64	YT-1096	61
YT-0641	299	YT-06876	365	YT-0751	68	YT-0822	290	YT-0864	142; 374	YT-09540	253	YT-1028	64	YT-1100	61
YT-0642	304	YT-06877	365	YT-07511	68	YT-0823	290	YT-0865	142; 374	YT-09564	254	YT-1029	63	YT-1102	61
YT-0643	333	YT-06878	364	YT-0754	69	YT-0824	290	YT-0866	142; 374	YT-09571	254	YT-1030	60	YT-1105	61
YT-0645	310	YT-06879	365	YT-0755	69	YT-0825	290	YT-0867	142; 374	YT-0959	254	YT-1031	60	YT-1110	61
YT-0646	311	YT-06880	363	YT-0760	68	YT-0826	291	YT-0870	142; 374	YT-0960	254	YT-1032	60	YT-1115	62
YT-0647	311	YT-06881	363	YT-07601	68	YT-08295	335	YT-08707	259; 336	YT-09611	255	YT-1033	60	YT-1119	62
YT-06475	313	YT-06882	362	YT-0761	69	YT-0830	335	YT-0880	336	YT-09615	255	YT-1034	60	YT-1121	62
YT-0648	312	YT-06883	360	YT-07611	68	YT-08305	335	YT-08802	336	YT-09632	256	YT-1035	60	YT-1122	62
YT-0650	311	YT-06884	361	YT-07641	68	YT-0831	335	YT-0882	289	YT-0965	256	YT-1036	60	YT-1123	62
YT-0651	311	YT-06885	361	YT-07642	68	YT-0835	336	YT-0883	289	YT-0967	257	YT-1037	60	YT-1124	62
YT-0652	311	YT-06888	359	YT-0770	69	YT-0836	307	YT-0884	289	YT-09675	256	YT-1038	60	YT-1127	62
YT-0653	312	YT-0690	296	YT-0771	69	YT-0837	307	YT-0885	289	YT-0970	258	YT-1039	60	YT-1128	62

YATO 	page/ strona	YATO 	page/ strona	YATO 	page/ strona	YATO 	page/ strona	YATO 	page/ strona	YATO 	page/ strona	YATO 	page/ strona	YATO 	page/ strona	YATO 	page/ strona
YT-1211	31	YT-1272	32	YT-1317	53	YT-1420	23	YT-1517	86	YT-1604	13	YT-1670	9	YT-1767	158; 344	YT-1939	167; 233; 378
YT-1212	31	YT-1273	32	YT-1318	53	YT-1421	23	YT-1518	86	YT-1605	13	YT-1671	9	YT-1768	158; 344		
YT-1213	31	YT-1274	32	YT-1319	53	YT-1422	23	YT-15271	17	YT-1606	13	YT-1672	9	YT-1769	158; 344	YT-1940	95
YT-1214	31	YT-1275	32	YT-1320	53	YT-1423	23	YT-15272	17	YT-1607	13	YT-1673	9	YT-1843	167	YT-1941	95
YT-1215	31	YT-1276	32	YT-1322	53	YT-1424	23	YT-15273	17	YT-1608	13	YT-1674	9	YT-1844	167	YT-1942	95
YT-1216	31	YT-1277	32	YT-1323	53	YT-1425	24	YT-15274	17	YT-1609	13	YT-1675	9	YT-1845	167	YT-1943	95
YT-1217	31	YT-1278	32	YT-1324	53	YT-1426	24	YT-15275	17	YT-1610	13	YT-1676	9	YT-1846	167	YT-1944	95
YT-1218	31	YT-1279	32	YT-1326	53	YT-1427	24	YT-15276	17	YT-1611	13	YT-1677	9	YT-1847	167	YT-1945	95
YT-1219	31	YT-1280	32	YT-1328	53	YT-1429	23	YT-15277	17	YT-1612	13	YT-1678	9	YT-1848	167	YT-1946	95
YT-1220	31	YT-1281	32	YT-1330	53	YT-1430	23	YT-15278	17	YT-1613	13	YT-1679	9	YT-1851	167	YT-1947	95
YT-1221	32	YT-1282	32	YT-1334	54	YT-1431	23	YT-15279	17	YT-1614	13	YT-1680	9	YT-1852	167	YT-1948	95
YT-1222	32	YT-1283	32	YT-1335	54	YT-1432	23	YT-15280	17	YT-1615	13	YT-1681	9	YT-1853	167	YT-1949	100
YT-1223	32	YT-1284	32	YT-1340	53	YT-1433	23	YT-15281	17	YT-1616	13	YT-1682	9	YT-1854	167	YT-1950	99
YT-1224	32	YT-1285	32	YT-1341	53	YT-1434	23	YT-15282	17	YT-1617	13	YT-1683	9	YT-1855	167	YT-1951	99
YT-1225	32	YT-1286	32	YT-1342	53	YT-1435	23	YT-15283	17	YT-1618	13	YT-1684	9	YT-1856	167	YT-1952	99
YT-1226	32	YT-1289	32	YT-1345	54	YT-1436	23	YT-15284	17	YT-1619	13	YT-1685	9	YT-18600	121; 168	YT-1953	99
YT-1227	32	YT-1291	32	YT-13465	54	YT-1437	24	YT-15291	17	YT-1620	13	YT-1686	9	YT-18602	121; 168	YT-1954	99
YT-1228	32	YT-1292	32	YT-1347	54	YT-1438	24	YT-15292	17	YT-1621	13	YT-1687	9	YT-18610	120; 168	YT-1956	99
YT-1229	32	YT-12930	32	YT-13475	54	YT-14411	49	YT-15293	17	YT-1622	13	YT-1688	9	YT-18611	120; 168	YT-1960	164; 230; 375
YT-1230	32	YT-12931	32	YT-1348	54	YT-14421	49	YT-1530	87	YT-1627	15	YT-1690	9	YT-18612	120; 168		
YT-1231	32	YT-12932	32	YT-13490	54	YT-14431	37	YT-1531	87	YT-1628	15	YT-17000	347	YT-1900	166; 231; 376	YT-1961	165; 231; 376
YT-1232	32	YT-12933	32	YT-1350	53	YT-14451	37	YT-1532	87	YT-1629	15	YT-17001	347				
YT-1233	32	YT-12934	32	YT-1352	53	YT-14461	37	YT-1533	87	YT-1630	15	YT-17002	347	YT-1901	166; 231; 376	YT-1962	165; 230; 375
YT-1234	32	YT-12935	32	YT-1355	53	YT-14471	38	YT-1534	87	YT-1631	15	YT-17003	347				
YT-1235	32	YT-12936	32	YT-1356	33	YT-14481	38	YT-1535	87	YT-1632	15	YT-17004	347	YT-1902	166; 231; 376	YT-1963	166; 232; 377
YT-1236	32	YT-12937	32	YT-1360	54	YT-14491	37	YT-1537	87	YT-1633	15	YT-17005	347				
YT-1237	32	YT-12938	32	YT-1370	306	YT-14501	38	YT-1539	87	YT-1634	15	YT-17006	347	YT-1910	164; 230; 375	YT-1964	166; 232; 377
YT-1238	32	YT-12939	32	YT-1371	306	YT-1460	32	YT-1541	16	YT-1635	15	YT-17007	347				
YT-1239	32	YT-12940	32	YT-1372	306	YT-1461	32	YT-1542	16	YT-1636	15	YT-17008	347	YT-1911	165; 231; 376	YT-1965	166; 232; 377
YT-1240	32	YT-12941	32	YT-1373	306	YT-1462	32	YT-1543	16	YT-1637	15	YT-17009	347				
YT-1241	34	YT-12942	32	YT-1374	306	YT-1463	32	YT-1544	16	YT-1638	15	YT-1702	347	YT-1912	165; 230; 375	YT-1966	121; 164
YT-1242	34	YT-12943	32	YT-1375	306	YT-1464	32	YT-1545	16	YT-1639	15	YT-1704	347				
YT-1243	34	YT-12944	32	YT-1378	306	YT-1465	32	YT-1546	16	YT-1640	15	YT-1706	347	YT-1913	165; 230; 375	YT-1967	121; 164
YT-12439	34	YT-12945	32	YT-1379	306	YT-1466	32	YT-1547	16	YT-1641	15	YT-1707	347				
YT-1244	34	YT-12946	32	YT-13790	306	YT-1467	32	YT-1548	16	YT-1642	15	YT-1709	347	YT-1914	165; 231; 376	YT-1969	121; 164
YT-12445	34	YT-12947	32	YT-1381	306	YT-1468	32	YT-1549	16	YT-1644	15	YT-1711	347				
YT-1246	33	YT-12948	32	YT-1382	306	YT-1469	32	YT-1552	16	YT-1647	15	YT-1713	347	YT-1915	164; 230; 375	YT-1970	166; 232; 377
YT-1247	33	YT-12949	32	YT-1385	306	YT-1470	32	YT-1553	16	YT-1649	15	YT-1714	347				
YT-1248	33	YT-1295	33	YT-1400	24	YT-1471	32	YT-1554	16	YT-1650	15	YT-1715	347	YT-1916	165; 231; 376	YT-1974	120; 181
YT-1249	33	YT-1296	28	YT-1401	23	YT-1472	32	YT-1555	16	YT-1651	9	YT-1720	348				
YT-1250	33	YT-1297	24	YT-1403	23	YT-1473	32	YT-1556	16	YT-1652	9	YT-1721	348	YT-1918	164; 230; 375	YT-19763	181
YT-1251	33	YT-1301	53	YT-1404	23	YT-1474	32	YT-1557	16	YT-1653	9	YT-17211	348				
YT-1252	34	YT-1302	53	YT-1405	23	YT-1475	32	YT-1558	16	YT-1654	9	YT-17310	348	YT-1919	165; 231; 376	YT-19764	181
YT-1253	34; 326	YT-1303	53	YT-1406	23	YT-1476	32	YT-1559	16	YT-1655	9	YT-17311	348				
YT-1254	34; 326	YT-1304	53	YT-1407	23	YT-1478	32	YT-1565	16	YT-1656	9	YT-17312	348	YT-1920	166; 232; 377	YT-19765	181
YT-1255	33	YT-1305	53	YT-1408	23	YT-1480	32	YT-1566	16	YT-1657	9	YT-1751	319				
YT-1258	33	YT-1306	53	YT-1409	23	YT-1481	32	YT-1567	16	YT-1658	9	YT-1752	319	YT-1922	165; 230; 375	YT-1988	102
YT-1259	33	YT-1307	53	YT-1410	23	YT-1501	86	YT-1571	17	YT-1659	9	YT-1753	319				
YT-12621	49	YT-1308	53	YT-1411	23	YT-1502	86	YT-1573	17	YT-1660	9	YT-1754	319	YT-1923	165; 230; 375	YT-1989	102
YT-12651	50	YT-1309	53	YT-1412	23	YT-1503	86	YT-1574	17	YT-1661	9	YT-1756	319				
YT-12671	50	YT-1310	53	YT-1413	23	YT-1505	86	YT-1575	17	YT-1662	9	YT-1757	293	YT-1924	166; 232; 377	YT-1990	102
YT-12681	42	YT-1311	53	YT-1414	23	YT-1507	86	YT-1576	17	YT-1663	9	YT-1762	320				
YT-12682	50	YT-1312	53	YT-1415	23	YT-1508	86	YT-1577	17	YT-1664	9	YT-17625	320	YT-1925	166; 232; 377	YT-1991	102
YT-12685	42	YT-1313	53	YT-1416	23	YT-1511	86	YT-1578	17	YT-1665	9	YT-1763	158; 344				
YT-12691	41	YT-1314	53	YT-1417	23	YT-1512	86	YT-1601	13	YT-1666	9	YT-1764	158; 344	YT-19260	167; 232; 377	YT-1992	102
YT-1270	32	YT-1315	53	YT-1418	23	YT-1513	86	YT-1602	13	YT-1667	9	YT-1765	158; 344				
YT-1271	32	YT-1316	53	YT-1419	23	YT-1515	86	YT-1603	13	YT-1669	9	YT-1766	158; 344	YT-19261	167; 232; 377	YT-2006	95
														YT-1930	167; 378	YT-2007	95
														YT-1933	121; 164	YT-2008	95
																YT-2016	95
																YT-2018	95

YATO	page/ strona	YATO	page/ strona	YATO	page/ strona	YATO	page/ strona	YATO	page/ strona	YATO	page/ strona	YATO	page/ strona	YATO	page/ strona		
YT-2026	95	YT-20963	13; 112	YT-21058	33; 113	YT-2160	105; 372	YT-2225	106; 198	YT-22861	117	YT-2406	262	YT-25145	297; 308	YT-25904	74
YT-2028	95	YT-20964	13; 112	YT-21071	30; 113	YT-2161	105; 372	YT-22255	107; 199	YT-22862	117	YT-2407	262	YT-2515	297	YT-25905	74
YT-2029	96	YT-20965	13; 112	YT-21072	35; 113	YT-2162	105; 372	YT-22256	107; 199	YT-22870	168	YT-24091	263	YT-2516	297	YT-25906	74
YT-2030	96	YT-20966	13; 112	YT-21080	55; 114	YT-2165	18	YT-22260	107; 200	YT-22871	168	YT-24092	263	YT-2517	297	YT-25907	74
YT-2031	96	YT-20967	13; 112	YT-21081	55; 114	YT-21650	18	YT-2228	183; 201	YT-22872	168	YT-24093	263	YT-2518	297	YT-25908	74
YT-2036	95	YT-20968	13; 112	YT-21082	55; 114	YT-21651	18	YT-2229	183; 201	YT-22873	168	YT-24094	263	YT-2519	297	YT-25909	74
YT-2037	95	YT-20969	13; 112	YT-21083	55; 114	YT-21652	18	YT-2230	183; 201	YT-22874	168	YT-24095	263	YT-2520	297	YT-25910	74
YT-2039	100	YT-20980	12; 112	YT-21085	56; 114	YT-21653	18	YT-2231	183; 201	YT-22875	168	YT-24100	263	YT-2521	297	YT-25911	74
YT-2046	100	YT-20981	12; 112	YT-21086	56; 114	YT-21654	18	YT-22312	183; 201	YT-2293	117	YT-24101	263	YT-2522	297	YT-25912	74
YT-2047	100	YT-20982	12; 112	YT-21087	56; 114	YT-2166	18	YT-22313	184; 202	YT-22930	117	YT-24102	263	YT-2523	297	YT-25913	74
YT-2048	100	YT-20983	12; 112	YT-21088	56; 114	YT-2167	18	YT-22314	184; 202	YT-2294	118	YT-24103	263	YT-25331	308	YT-25914	74
YT-2050	100	YT-20984	12; 112	YT-21089	56; 114	YT-2168	18	YT-22315	184; 202	YT-2295	117	YT-24201	262	YT-2535	331	YT-25920	74
YT-2051	100	YT-20985	12; 112	YT-21095	17; 112	YT-2170	18	YT-22316	184; 202	YT-2296	115	YT-24202	262	YT-2536	331	YT-25921	74
YT-2052	100	YT-20986	12; 112	YT-21096	17; 112	YT-2171	18	YT-22317	184; 202	YT-2297	116	YT-24203	262	YT-2537	331	YT-25922	74
YT-2055	100	YT-20987	12; 112	YT-21120	86; 114	YT-2172	18	YT-22318	184; 202	YT-2298	115	YT-24204	262	YT-2539	300	YT-25923	74
YT-2056	100	YT-20988	12; 112	YT-21121	86; 114	YT-2173	18	YT-2232	184; 202	YT-2299	116	YT-24205	262	YT-25391	300	YT-25924	74
YT-2057	100	YT-20989	12; 112	YT-21122	86; 114	YT-21735	205	YT-2233	184; 202	YT-2300	115	YT-24206	262	YT-2540	299	YT-25925	74
YT-2058	100	YT-20990	12; 112	YT-21123	86; 114	YT-21740	205	YT-22338	184; 202	YT-2302	115	YT-24207	262	YT-2541	300	YT-25926	74
YT-2060	100	YT-20991	12; 112	YT-21125	86; 114	YT-21741	205	YT-2234	184; 202	YT-2305	116	YT-24208	262	YT-2542	301	YT-25927	74
YT-2061	100	YT-20992	12; 112	YT-21126	86; 114	YT-21742	205	YT-2235	184; 202	YT-2307	115	YT-24209	262	YT-2543	301	YT-25928	74
YT-2063	100	YT-20993	12; 112	YT-21127	86; 114	YT-21743	205	YT-22353	183; 201	YT-2313	118	YT-24220	262	YT-2544	331	YT-25929	74
YT-2064	100	YT-20994	12; 112	YT-21141	121; 164	YT-21744	205	YT-22354	183; 201	YT-2316	119	YT-24221	262	YT-2546	331	YT-25930	74
YT-2066	96	YT-20995	12; 112	YT-21151	98; 111	YT-21745	205	YT-22355	183; 201	YT-2319	118	YT-24224	262	YT-2547	331	YT-25931	74
YT-2067	96	YT-20996	12; 112	YT-21152	98; 111	YT-21746	205	YT-22360	206	YT-2340	260	YT-24225	262	YT-25480	308	YT-25932	74
YT-2069	106; 200	YT-20997	12; 112	YT-21153	98; 111	YT-21747	205	YT-22361	206	YT-2341	260	YT-24240	262	YT-25802	78	YT-25933	74
YT-2070	106; 200	YT-20998	12; 112	YT-21154	98; 111	YT-2180	203	YT-22373	203	YT-2346	260	YT-24301	344	YT-25803	78	YT-25934	74
YT-2071	18	YT-20999	12; 112	YT-21155	98; 111	YT-2182	203	YT-22374	203	YT-2357	260	YT-2449	103	YT-25804	78	YT-25940	74
YT-2072	18	YT-21008	27; 113	YT-21158	98; 111	YT-21840	203	YT-22380	234	YT-2370	259	YT-2450	103	YT-25805	78	YT-25941	74
YT-2073	18	YT-21010	27; 113	YT-21159	98; 111	YT-21842	203	YT-2240	116	YT-23701	259	YT-2451	103	YT-25806	78	YT-25942	74
YT-2074	18	YT-21011	27; 113	YT-21160	98; 111	YT-21843	203	YT-2242	116	YT-2371	259	YT-2452	103	YT-25807	78	YT-25943	74
YT-2075	18	YT-21012	27; 113	YT-21161	98; 111; 200	YT-21844	203	YT-22422	116	YT-2372	259	YT-2453	103	YT-25808	78	YT-25950	74
YT-2080	97	YT-21013	27; 113			YT-21845	203	YT-2243	116	YT-2373	260	YT-2459	103	YT-25809	78	YT-25951	74
YT-2081	97	YT-21014	27; 113	YT-21190	114; 140	YT-21846	203	YT-2244	116	YT-23731	260	YT-2460	103	YT-25810	78	YT-25952	74
YT-2082	97	YT-21016	27; 113	YT-21191	98; 111	YT-21850	203	YT-2245	114	YT-2374	260	YT-2461	104; 372	YT-25811	78	YT-25953	74
YT-2083	97	YT-21017	27; 113	YT-21200	120; 181	YT-21851	203	YT-2246	115	YT-2375	260	YT-2463	104; 372	YT-25831	78	YT-25954	74
YT-2084	97	YT-21018	27; 113	YT-21210	120; 177	YT-21852	203	YT-2247	116	YT-2376	261	YT-2466	104; 372	YT-25832	78	YT-25955	74
YT-2085	97	YT-21019	27; 113	YT-21211	120; 177	YT-22000	107; 199	YT-2249	116	YT-2380	261	YT-2468	104; 372	YT-25833	78	YT-25956	74
YT-2086	97	YT-21021	27; 113	YT-2130	101	YT-22001	107; 199	YT-2250	115	YT-2381	261	YT-2469	104; 372	YT-25834	78	YT-25957	74
YT-2090	106; 200	YT-21022	27; 113	YT-2136	101	YT-22002	107; 199	YT-2251	115	YT-2382	261	YT-2473	103	YT-25835	78	YT-25958	74
YT-2091	106; 200	YT-21030	31; 113	YT-2137	101	YT-22005	107; 199	YT-2254	117	YT-2383	261	YT-2476	103	YT-25836	78	YT-25959	74
YT-20911	106; 200	YT-21031	31; 113	YT-2138	101	YT-2201	106; 198	YT-2255	115	YT-2384	261	YT-2482	106; 198	YT-25837	78	YT-25960	74
YT-20940	18; 112	YT-21032	31; 113	YT-2139	101	YT-2203	106; 198	YT-2256	115	YT-2385	261	YT-2483	106; 198	YT-25838	78	YT-25961	74
YT-20941	18; 112	YT-21033	31; 113	YT-2140	102	YT-2204	106; 198	YT-2260	119	YT-2390	262	YT-2484	106; 198	YT-25839	78	YT-25965	75
YT-20942	18; 112	YT-21034	31; 113	YT-2141	102	YT-2205	106; 198	YT-2261	119	YT-2391	262	YT-2485	106; 198	YT-25840	78	YT-25966	75
YT-20950	13; 112	YT-21036	31; 113	YT-2142	102	YT-2206	106; 198	YT-2262	119	YT-2392	262	YT-2488	106; 198	YT-25852	78	YT-25967	75
YT-20951	13; 112	YT-21037	31; 113	YT-2143	102	YT-2210	199	YT-2263	119	YT-2393	262	YT-2489	106; 198	YT-25853	78	YT-25968	76
YT-20952	13; 112	YT-21038	31; 113	YT-2144	102	YT-2211	199	YT-2266	118	YT-2394	262	YT-2490	106; 198	YT-25854	78	YT-25971	76
YT-20953	13; 112	YT-21039	31; 113	YT-2145	102	YT-2212	199	YT-2267	118	YT-2395	262	YT-2491	106; 198	YT-25855	78	YT-25972	80
YT-20954	13; 112	YT-21041	31; 113	YT-2146	102	YT-2213	199	YT-2268	119	YT-2396	262	YT-2492	106; 198	YT-25856	78	YT-25980	75
YT-20955	13; 112	YT-21042	31; 113	YT-2147	102	YT-2214	199	YT-2270	118	YT-2397	262	YT-2493	106; 198	YT-25857	78	YT-25981	76
YT-20956	13; 112	YT-21044	31; 113	YT-2151	103	YT-2215	199	YT-2274	119	YT-2398	262	YT-2494	106; 198	YT-25861	78	YT-25982	76
YT-20957	13; 112	YT-21047	31; 113	YT-2152	103	YT-2216	199	YT-2275	119	YT-2399	262	YT-2510	298	YT-25862	78	YT-25985	74
YT-20958	13; 112	YT-21050	31; 113	YT-2153	103	YT-2217	199	YT-2276	119	YT-2401	262	YT-25105	298	YT-25863	78	YT-25986	74
YT-20959	13; 112	YT-21052	31; 113	YT-2155	103	YT-2218	199	YT-2278	118	YT-2402	262	YT-2511	297	YT-25900	74	YT-25987	74
YT-20960	13; 112	YT-21055	28; 113	YT-2156	103	YT-2222	106; 198	YT-2279	119	YT-2403	262	YT-2512	297	YT-25901	74	YT-25988	74
YT-20961	13; 112	YT-21056	28; 113	YT-21570	104; 372	YT-2223	106; 198	YT-2280	120	YT-2404	262	YT-2513	297	YT-25902	74	YT-25989	74
YT-20962	13; 112	YT-21057	33; 113	YT-21582	153; 374	YT-2224	106; 198	YT-22860	117	YT-2405	262	YT-2514	297	YT-25903	74	YT-25990	74

YATO	page/ strona	YATO	page/ strona	YATO	page/ strona	YATO	page/ strona	YATO	page/ strona	YATO	page/ strona	YATO	page/ strona	YATO	page/ strona	YATO	page/ strona
YT-25991	74	YT-2798	80	YT-2912	198	YT-2979	156	YT-3103	169	YT-3269	152	YT-3350	154	YT-35854	182	YT-36700	204; 219; 400
YT-25992	74	YT-28003	81	YT-2913	198	YT-2980	158	YT-3106	169	YT-3270	152	YT-3351	154	YT-35855	182	YT-36704	204; 219; 401
YT-25993	74	YT-2801	81	YT-2914	198	YT-2981	158	YT-3107	169	YT-3271	152	YT-3353	154	YT-35856	182	YT-36706	204; 219; 400
YT-25994	74	YT-28015	81	YT-2916	198	YT-2982	158	YT-3108	169	YT-3272	152	YT-3370	155	YT-35857	182	YT-36709	204; 219; 401
YT-25995	74	YT-2802	81	YT-2917	198	YT-2983	158	YT-3130	169	YT-3273	152	YT-3371	155	YT-35858	182	YT-3701	224
YT-25996	74	YT-2806	80	YT-2918	198	YT-2984	158	YT-3133	169	YT-3274	152	YT-3372	155	YT-35859	182	YT-3703	224
YT-25997	74	YT-2810	81	YT-2919	198	YT-2985	158	YT-3134	169	YT-3275	152	YT-3373	155	YT-35860	182	YT-3704	225
YT-25998	75	YT-2811	81	YT-2920	198	YT-2986	157	YT-3150	169	YT-3276	152	YT-3374	155	YT-35861	182	YT-3705	225
YT-2601	77	YT-2812	81	YT-2921	198	YT-2987	157	YT-3160	170	YT-3277	152	YT-3376	155	YT-35862	182	YT-3706	225
YT-2602	77	YT-2815	79; 110	YT-2926	156	YT-2988	157	YT-3161	170	YT-3278	152	YT-3377	155	YT-35863	182	YT-3707	225
YT-2604	77	YT-2816	79; 110	YT-2930	156	YT-2989	157	YT-3163	170	YT-3279	152	YT-3380	155	YT-35864	182	YT-3708	225
YT-2606	77	YT-2817	79; 110	YT-2931	156	YT-2990	157	YT-3200	170; 467	YT-3280	152	YT-3381	155	YT-35865	182	YT-3712	224
YT-2608	77	YT-2818	79; 110	YT-2932	156	YT-2991	157	YT-3201	170; 467	YT-3281	152	YT-3400	171	YT-35866	182	YT-3713	224
YT-2609	77	YT-2819	79; 110	YT-2933	156	YT-2992	158	YT-3202	170; 467	YT-3282	152	YT-3401	171	YT-35867	182	YT-3714	225
YT-2610	77	YT-2820	79; 110	YT-2934	156	YT-2993	158	YT-3203	170; 467	YT-3283	152	YT-3402	171	YT-35868	182	YT-3716	225
YT-2612	77	YT-2821	79; 110	YT-2935	156	YT-2994	158	YT-3204	170; 467	YT-3284	152	YT-3403	171	YT-35869	182	YT-3717	225
YT-2613	77	YT-2822	79; 110	YT-2937	156	YT-2995	158	YT-3221	170; 467	YT-3285	152	YT-3404	171	YT-35870	182	YT-3725	153
YT-2614	77	YT-2823	79; 110	YT-2939	156	YT-2996	158	YT-3222	170; 467	YT-3286	152	YT-3405	171	YT-35871	182	YT-3726	153
YT-2615	77	YT-2824	79; 110	YT-2940	156	YT-2997	157	YT-3223	170; 467	YT-3287	152	YT-3407	171	YT-35872	182	YT-3727	153
YT-2618	77	YT-2825	79; 110	YT-2941	156	YT-2998	248	YT-3224	170; 467	YT-3288	152	YT-3408	171	YT-35873	182	YT-3728	153
YT-2633	77	YT-2826	79; 110	YT-2942	156	YT-2998	248	YT-3230	170; 467	YT-3289	152	YT-3409	171	YT-35880	182	YT-3730	224
YT-2634	77	YT-2827	79; 110	YT-2943	156	YT-2998	248	YT-3231	170; 467	YT-3290	152	YT-3410	171	YT-35881	182	YT-3735	182; 226
YT-2635	77	YT-2828	79; 110	YT-2944	156	YT-3001	247	YT-3232	170; 467	YT-3291	152	YT-3411	171	YT-35890	182	YT-3736	182; 226
YT-2636	77	YT-28290	79; 110	YT-2945	156	YT-3002	247	YT-3233	170; 467	YT-3292	152	YT-3412	171	YT-3591	182	YT-3740	181
YT-2640	77	YT-28293	79; 110	YT-2946	156	YT-3003	247	YT-3234	170; 467	YT-3293	152	YT-3413	171	YT-3600	212	YT-3744	229
YT-2641	77	YT-28300	122	YT-2947	156	YT-3004	247	YT-3236	151	YT-3294	152	YT-3414	171	YT-36007	212	YT-3745	229
YT-2642	77	YT-2861	122; 242	YT-2948	156	YT-3005	247	YT-3237	151	YT-3295	152	YT-3415	171	YT-36011	212	YT-37690	60
YT-2643	77	YT-2862	122; 242	YT-2949	156	YT-3006	247	YT-3238	151	YT-3296	152	YT-3416	171	YT-36012	212	YT-3801	27
YT-2644	77	YT-28630	122; 242	YT-2950	156	YT-3006	247	YT-3239	151	YT-3297	152	YT-3417	171	YT-36060	212	YT-3802	27
YT-2645	77	YT-28631	122	YT-2951	156	YT-3006	247	YT-3240	151	YT-3298	152	YT-3421	171	YT-3609	212	YT-3803	27
YT-2647	77	YT-2864	122	YT-2952	156	YT-3006	247	YT-3241	151	YT-3299	152	YT-3434	171	YT-36092	212	YT-3804	27
YT-2648	77	YT-2865	343	YT-2953	156	YT-3007	247	YT-3242	151	YT-3300	152	YT-3435	171	YT-36095	212	YT-3805	27
YT-2649	77	YT-2866	343	YT-2954	156	YT-3007	247	YT-3243	151	YT-3303	154	YT-3440	171	YT-3610	213	YT-3806	27
YT-2650	77	YT-28920	153; 373	YT-2955	156	YT-3007	247	YT-3244	151	YT-3304	154	YT-3441	171	YT-36112	213	YT-3807	27
YT-2653	77	YT-28921	153; 373	YT-2956	156	YT-3007	247	YT-3245	151	YT-3306	154	YT-3442	171	YT-36119	213	YT-3808	27
YT-2655	77	YT-28950	153	YT-2957	156	YT-3022	247	YT-3246	151	YT-3308	154	YT-3443	171	YT-3612	213	YT-3809	27
YT-2657	77	YT-28951	153	YT-2958	156	YT-3023	247	YT-3247	151	YT-3311	154	YT-3444	171	YT-36127	213	YT-3810	27
YT-2658	77	YT-28952	153	YT-2959	156	YT-3024	247	YT-3248	151	YT-3313	154	YT-3445	171	YT-36128	213	YT-3811	27
YT-2661	77	YT-28953	153	YT-2960	157	YT-3025	247	YT-3249	151	YT-3315	154	YT-3460	170	YT-36129	213	YT-3812	27
YT-2663	77	YT-28954	153	YT-2961	157	YT-3026	247	YT-3250	151	YT-3317	154	YT-3461	170	YT-36140	213	YT-3813	27
YT-2665	77	YT-28955	153	YT-2962	157	YT-30370	247	YT-3251	151	YT-3318	154	YT-3462	170	YT-36171	214; 264	YT-3814	27
YT-2667	77	YT-28956	153	YT-2963	157	YT-30375	247	YT-3252	151	YT-3321	154	YT-34680	172	YT-3618	214; 264	YT-3815	27
YT-2668	77	YT-28957	153	YT-2964	157	YT-30400	247	YT-3253	151	YT-3322	154	YT-34681	172	YT-36420	360	YT-3816	27
YT-2670	78	YT-28958	153	YT-2965	157	YT-3071	234	YT-3254	151	YT-3323	154	YT-34682	172	YT-36451	214	YT-3817	27
YT-2741	77	YT-28959	153	YT-2966	157	YT-3072	234	YT-3255	151	YT-3324	154	YT-34683	172	YT-36452	214	YT-3818	27
YT-2742	77	YT-28960	153	YT-2967	157	YT-3073	234	YT-3256	151	YT-3327	154	YT-34684	173	YT-36453	214	YT-3819	27
YT-2743	77	YT-28961	153	YT-2968	157	YT-3074	234	YT-3257	151	YT-3329	154	YT-34685	173	YT-36454	214	YT-3820	27
YT-2744	77	YT-28962	153	YT-2969	157	YT-3076	234	YT-3258	151	YT-3330	154	YT-34686	173	YT-36460	214	YT-3821	27
YT-2745	77	YT-28963	153	YT-2970	157	YT-3077	234	YT-3259	151	YT-3332	154	YT-34687	173	YT-36470	214	YT-3822	27
YT-2746	77	YT-28964	153	YT-2971	157	YT-3078	234	YT-3261	152	YT-3333	154	YT-34688	174	YT-36471	214	YT-3823	27
YT-2748	77	YT-28965	153	YT-2972	157	YT-3079	234	YT-3262	152	YT-3334	154	YT-34689	174	YT-36472	214	YT-3824	27
YT-2750	77	YT-28966	153	YT-2973	157	YT-3081	234	YT-3263	152	YT-3336	154	YT-34690	174	YT-36473	214	YT-3825	27
YT-2752	77	YT-28967	153	YT-2974	157	YT-3082	234	YT-3264	152	YT-3338	154	YT-34691	174	YT-36474	214	YT-3826	27
YT-2753	77	YT-2900	198	YT-2975	156	YT-3083	234	YT-3265	152	YT-3343	154	YT-35850	182	YT-36475	214	YT-3827	27
YT-2754	77	YT-29001	198	YT-2976	157	YT-3084	234	YT-3266	152	YT-3345	154	YT-35851	182	YT-36476	214	YT-3828	27
YT-2756	77	YT-2910	198	YT-2977	157	YT-3101	169	YT-3267	152	YT-3346	154	YT-35852	182	YT-36480	214	YT-3829	27
YT-2797	80	YT-2911	198	YT-2978	156	YT-3102	169	YT-3268	152	YT-3349	154	YT-35853	182	YT-36481	214	YT-3830	27

YATO	page/ strona	YATO	page/ strona	YATO	page/ strona	YATO	page/ strona	YATO	page/ strona	YATO	page/ strona	YATO	page/ strona	YATO	page/ strona		
YT-3828	27	YT-4045	147	YT-4202	149	YT-4430	147	YT-44664	148	YT-4518	132; 371	YT-46836	136	YT-4878	8	YT-5228	228
YT-3829	27	YT-4048	147	YT-4203	149	YT-4431	147	YT-44666	148	YT-4519	132; 371	YT-4690	135	YT-4879	8	YT-5230	228
YT-3830	27	YT-4050	147	YT-4204	149	YT-4432	147	YT-44667	148	YT-4520	132; 371	YT-4691	135	YT-4880	8	YT-5234	228
YT-3831	27	YT-4052	147	YT-4205	149	YT-4433	147	YT-44668	148	YT-4521	132; 371	YT-4692	135	YT-4881	8	YT-5237	228
YT-3832	27	YT-4055	147	YT-4206	149	YT-4434	147	YT-44673	149	YT-4522	132; 371	YT-4693	135	YT-4882	8	YT-5240	228
YT-3833	27	YT-4060	147	YT-4207	149	YT-4435	147	YT-44674	149	YT-4550	130	YT-4694	135	YT-4883	8	YT-5242	228
YT-3839	29	YT-4065	147	YT-4208	149	YT-4436	147	YT-44675	149	YT-4551	130	YT-4695	135	YT-4884	8	YT-5243	228
YT-3840	28	YT-4070	147	YT-4209	149	YT-4437	147	YT-44676	149	YT-4552	130	YT-4700	133	YT-4885	8	YT-5245	228
YT-3841	29	YT-4075	147	YT-4210	149	YT-4438	147	YT-44700	149	YT-4553	130	YT-4701	133	YT-4901	8	YT-5247	228
YT-3842	27	YT-4080	147	YT-4211	149	YT-4439	147	YT-44705	149	YT-4560	131	YT-4705	133	YT-4902	8	YT-5260	226
YT-3843	27	YT-4085	147	YT-4212	149	YT-4440	147	YT-44740	157	YT-4561	131	YT-4710	133	YT-4903	8	YT-5261	226
YT-3844	27	YT-4090	147	YT-4213	149	YT-4441	147	YT-44741	157	YT-4562	131	YT-4711	134	YT-4904	8	YT-5262	226
YT-3845	27	YT-4100	147	YT-4214	149	YT-4442	147	YT-44750	148	YT-4563	131	YT-4712	134	YT-4905	8	YT-52621	226
YT-3847	28	YT-4110	147	YT-4215	149	YT-4443	147	YT-44751	148	YT-4564	131	YT-47121	134	YT-4906	8	YT-52630	226
YT-3848	28	YT-4120	147	YT-4216	149	YT-4444	147	YT-44752	148	YT-4570	131	YT-4713	135	YT-4907	8	YT-52631	226
YT-3849	28	YT-4140	147	YT-4217	149	YT-4445	147	YT-44754	148	YT-4571	131	YT-4714	135	YT-4908	8	YT-5400	233
YT-3850	28	YT-4160	147	YT-4218	149	YT-4446	147	YT-44755	148	YT-4573	131	YT-47141	134	YT-4909	8	YT-5402	233
YT-3851	29; 326	YT-41602	148	YT-4219	149	YT-4447	147	YT-44756	148	YT-4590	132; 371	YT-47142	134	YT-4910	8	YT-5404	233
YT-38510	29	YT-41603	148	YT-4220	149	YT-4448	147	YT-44757	148	YT-4594	132	YT-47143	134	YT-4911	8	YT-5405	233
YT-38511	29	YT-41604	148	YT-4221	149	YT-4449	147	YT-44758	148	YT-4600	132	YT-47144	134	YT-4912	8	YT-5410	233
YT-38512	29	YT-41605	148	YT-4222	149	YT-4450	147	YT-44759	148	YT-4601	132	YT-47145	134	YT-4915	15	YT-5415	233; 378
YT-3853	28	YT-4161	150	YT-4223	149	YT-4451	147	YT-44760	148	YT-4602	132	YT-47146	134	YT-4916	15	YT-5416	233; 378
YT-3854	28	YT-4162	150	YT-4224	149	YT-4452	147	YT-44761	148	YT-4603	132	YT-47147	134	YT-4917	15	YT-5417	233; 378
YT-38561	39	YT-4163	150	YT-4225	149	YT-4453	147	YT-44763	148	YT-4604	132	YT-47148	134	YT-4918	15	YT-54230	234
YT-38631	49	YT-4164	150	YT-4226	149	YT-4454	147	YT-44764	148	YT-4605	132	YT-47149	134	YT-4919	15	YT-54233	234
YT-38641	49	YT-41641	150	YT-4227	149	YT-4455	147	YT-44765	148	YT-4620	132; 371	YT-47150	134	YT-4920	15	YT-5490	237
YT-3865	52	YT-41642	150	YT-4228	149	YT-4456	147	YT-44766	148	YT-4622	132; 371	YT-47151	134	YT-4921	15	YT-5491	237
YT-38671	40	YT-4165	150	YT-4229	149	YT-4457	147	YT-44767	148	YT-4623	132; 371	YT-47152	134	YT-4922	15	YT-5492	237
YT-38681	39	YT-4166	150	YT-4230	149	YT-4458	147	YT-44768	148	YT-4624	132; 371	YT-47160	181	YT-4923	15	YT-5493	237
YT-38741	40	YT-4167	150	YT-4350	152	YT-4460	147	YT-44769	148	YT-4625	132; 371	YT-47161	181	YT-4924	15	YT-5494	237
YT-38781	40	YT-4168	150	YT-4351	152	YT-4461	147	YT-44770	148	YT-4626	132; 371	YT-4720	154	YT-4925	15	YT-5496	237
YT-38791	43	YT-4169	150	YT-4352	152	YT-4462	147	YT-44772	148	YT-46270	132	YT-4721	154	YT-4926	15	YT-5497	237
YT-38801	45	YT-4170	150	YT-4353	152	YT-44630	148	YT-44773	148	YT-46273	132	YT-4722	154	YT-4927	15	YT-5499	237
YT-38811	47	YT-4171	150	YT-4354	152	YT-44631	148	YT-44774	148	YT-4630	132; 371	YT-4723	154	YT-4928	15	YT-5500	237
YT-38821	39	YT-4172	150	YT-4355	152	YT-44632	148	YT-44776	148	YT-4631	132; 371	YT-4730	136	YT-4937	15	YT-5501	237
YT-38831	44	YT-4173	150	YT-4356	152	YT-44633	148	YT-4491	130	YT-4632	132; 371	YT-4750	176	YT-4945	16	YT-5502	237
YT-38841	48	YT-4174	150	YT-4357	152	YT-44634	148	YT-4492	130	YT-4633	132; 371	YT-4751	176	YT-5038	11	YT-5503	237
YT-38861	39	YT-4175	150	YT-4358	152	YT-44635	148	YT-4493	130	YT-4634	132; 371	YT-4752	176	YT-5130	105; 373	YT-5504	237
YT-38872	46	YT-4176	150	YT-4359	152	YT-44637	148	YT-4494	130	YT-46800	136	YT-4755	176	YT-5131	105; 373	YT-5505	237
YT-38875	45	YT-4177	150	YT-4361	150	YT-44639	148	YT-4495	130	YT-46801	136	YT-4757	177	YT-51311	105; 373	YT-5506	237
YT-38881	46	YT-4178	150	YT-4362	150	YT-44640	148	YT-4496	130	YT-46802	136	YT-4758	177	YT-51320	105; 373	YT-5507	237
YT-38891	43	YT-4179	150	YT-4363	150	YT-44642	148	YT-4497	130	YT-46803	136	YT-4759	177	YT-5140	105; 373	YT-5508	237
YT-38901	44	YT-4180	150	YT-4364	150	YT-44643	148	YT-4498	130	YT-46804	136	YT-4761	177	YT-5141	105; 373	YT-55210	279
YT-38911	41	YT-4181	150	YT-4367	150	YT-44645	148	YT-4499	130	YT-46810	136	YT-4763	177	YT-5142	105; 373	YT-55280	270
YT-38931	47	YT-4182	150	YT-4369	150	YT-44650	148	YT-4500	130	YT-46811	136	YT-4764	177	YT-51450	215; 229	YT-55290	275
YT-38941	48	YT-4183	150	YT-4370	150	YT-44652	148	YT-4501	130	YT-46812	136	YT-4766	177	YT-51451	215; 229	YT-55291	269
YT-3895	289	YT-4184	150	YT-4375	150	YT-44653	148	YT-4502	130	YT-46813	136	YT-4767	177	YT-5200	227	YT-55292	274
YT-38951	290	YT-4185	150	YT-4376	150	YT-44654	148	YT-4503	130	YT-46814	136	YT-4768	177	YT-5202	227	YT-55293	271
YT-39009	51; 126	YT-4186	150	YT-4379	150	YT-44655	148	YT-4504	130	YT-46820	136	YT-4769	177	YT-5203	227	YT-55299	278
YT-39280	51	YT-4187	150	YT-4380	150	YT-44656	148	YT-4505	130	YT-46821	136	YT-4870	8	YT-5204	227	YT-5530	272
YT-4020	147	YT-4188	150	YT-4383	150	YT-44657	148	YT-4506	130	YT-46822	136	YT-4871	8	YT-5207	227	YT-55300	273
YT-4025	147	YT-4189	150	YT-4385	150	YT-44658	148	YT-4507	130	YT-46823	136	YT-4872	8	YT-5209	227	YT-5531	280
YT-4030	147	YT-4190	150	YT-4390	150	YT-44659	148	YT-4508	130	YT-46831	136	YT-4873	8	YT-5210	227	YT-55311	286
YT-4032	147	YT-4191	150	YT-4400	154	YT-44660	148	YT-4509	130	YT-46832	136	YT-4874	8	YT-5212	227	YT-5532	280
YT-4035	147	YT-4192	150	YT-4401	154	YT-44661	148	YT-4510	130	YT-46833	136	YT-4875	8	YT-5214	227	YT-55321	286
YT-4040	147	YT-4200	149	YT-4402	154	YT-44662	148	YT-4515	132; 371	YT-46834	136	YT-4876	8	YT-5218	227	YT-5533	280
YT-4042	147	YT-4201	149	YT-4403	154	YT-44663	148	YT-4516	132; 371	YT-46835	136	YT-4877	8	YT-5226	228	YT-55331	286

YATO 	page/ strona	YATO 	page/ strona	YATO 	page/ strona	YATO 	page/ strona	YATO 	page/ strona	YATO 	page/ strona	YATO 	page/ strona	YATO 	page/ strona	YATO 	page/ strona	YATO 	page/ strona	YATO 	page/ strona	YATO 	page/ strona	YATO 	page/ strona	YATO 	page/ strona		
YT-5534	280	YT-5835	89	YT-6004	160	YT-6081	161	YT-6160	186	YT-6230	185	YT-6354	175	YT-6441	140	YT-6903	107; 125; 336	YT-6442	140	YT-6443	140	YT-6444	140	YT-6445	140	YT-6446	140	YT-6925	238
YT-55341	286	YT-5837	89	YT-6005	160	YT-6082	161	YT-6161	186	YT-6231	185	YT-6355	175	YT-6447	140														
YT-5535	282	YT-5838	89	YT-6012	160	YT-6083	161	YT-6162	186	YT-6232	185	YT-6356	175	YT-6449	140	YT-6927	238	YT-6448	140	YT-6449	140	YT-6450	140	YT-6451	140	YT-6928	238		
YT-55351	286	YT-58950	353	YT-6013	160	YT-6085	161	YT-6163	187	YT-62328	185	YT-6358	175	YT-6452	140	YT-69281	238	YT-6453	140	YT-6454	140	YT-6455	140	YT-6456	140	YT-69285	238		
YT-5536	282	YT-58951	353	YT-6014	160	YT-6086	161	YT-6164	187	YT-62329	185	YT-6359	175	YT-6457	140	YT-69286	238	YT-6360	175	YT-63701	176; 206	YT-6447	140	YT-6925	238				
YT-55361	286	YT-58953	353	YT-6015	160	YT-60905	161	YT-6165	187	YT-6233	185	YT-6360	175	YT-6446	140	YT-69287	238	YT-62331	185	YT-63702	176; 206	YT-6448	140	YT-6926	238				
YT-5537	283	YT-58954	353	YT-6016	160	YT-60907	161	YT-61678	189	YT-62331	185	YT-63701	176; 206	YT-6447	140	YT-6925	238	YT-61679	189	YT-62338	185	YT-63702	176; 206	YT-6448	140	YT-6926	238		
YT-55371	286	YT-58955	353	YT-6017	160	YT-6091	161	YT-61679	189	YT-62338	185	YT-63702	176; 206	YT-6448	140	YT-6926	238	YT-6093	161	YT-61680	189	YT-62339	185	YT-63703	176; 206	YT-6449	140	YT-6927	238
YT-5538	283	YT-58957	353	YT-6022	160	YT-6093	161	YT-61680	189	YT-62339	185	YT-63703	176; 206	YT-6449	140	YT-6927	238	YT-6095	161	YT-61681	189	YT-6234	185	YT-63704	176; 206	YT-6450	140	YT-6928	238
YT-55381	286	YT-58962	353	YT-6023	160	YT-6095	161	YT-61681	189	YT-6234	185	YT-63704	176; 206	YT-6450	140	YT-6928	238	YT-6097	161	YT-61690	189	YT-62341	185	YT-63705	176; 206	YT-6451	140	YT-69281	238
YT-5539	284	YT-58964	353	YT-6024	160	YT-6097	161	YT-61690	189	YT-62341	185	YT-63705	176; 206	YT-6451	140	YT-69281	238	YT-6099	161	YT-61691	189	YT-62348	185	YT-63740	176; 206	YT-6452	140	YT-69285	238
YT-55391	286	YT-58966	353	YT-6025	160	YT-6099	161	YT-61691	189	YT-62348	185	YT-63740	176; 206	YT-6452	140	YT-69285	238	YT-6101	162	YT-6180	185	YT-62349	185	YT-63951	140	YT-6453	140	YT-69286	238
YT-5540	284	YT-58967	353	YT-6030	160	YT-6101	162	YT-6180	185	YT-62349	185	YT-63951	140	YT-6453	140	YT-69286	238	YT-6102	162	YT-6181	185	YT-6235	185	YT-63952	140	YT-6454	140	YT-69287	238
YT-55401	286	YT-58968	353	YT-6032	160	YT-6102	162	YT-6181	185	YT-6235	185	YT-63952	140	YT-6454	140	YT-69287	238	YT-6103	162	YT-6182	185	YT-62351	185	YT-63953	140	YT-64551	229	YT-7000	215
YT-5541	283	YT-5901	235; 353; 414	YT-6045	160	YT-6103	162	YT-6182	185	YT-62351	185	YT-63953	140	YT-64551	229	YT-7000	215	YT-6104	162	YT-6183	185	YT-62358	185	YT-63954	140	YT-64552	229	YT-7001	215
YT-55411	286			YT-6046	160	YT-6104	162	YT-6183	185	YT-62358	185	YT-63954	140	YT-64552	229	YT-7001	215	YT-6105	162	YT-6184	185	YT-62359	185	YT-63955	140	YT-6501	141	YT-70020	215
YT-5542	283	YT-5902	235; 353; 414	YT-60480	161	YT-6105	162	YT-6184	185	YT-62359	185	YT-63955	140	YT-6501	141	YT-70020	215	YT-6107	162	YT-6185	185	YT-6236	185	YT-63956	140	YT-6502	141	YT-70021	216
YT-55421	286			YT-60482	161	YT-6107	162	YT-6185	185	YT-6236	185	YT-63956	140	YT-6502	141	YT-70021	216	YT-6108	162	YT-6186	185	YT-62361	185	YT-63957	140	YT-6503	141	YT-7003	215
YT-5543	280	YT-5904	235; 353; 414	YT-60484	161	YT-6108	162	YT-6186	185	YT-62361	185	YT-63957	140	YT-6503	141	YT-7003	215	YT-6110	162	YT-6187	185	YT-6237	186	YT-63958	140	YT-6504	141	YT-7004	216
YT-55443	280			YT-60488	161	YT-6110	162	YT-6187	185	YT-6237	186	YT-63958	140	YT-6504	141	YT-7004	216	YT-6112	162	YT-6188	185	YT-6238	186	YT-6401	140	YT-65048	141	YT-7005	215
YT-55444	282	YT-5905	235; 353; 414	YT-60489	161	YT-6112	162	YT-6188	185	YT-6238	186	YT-6401	140	YT-65048	141	YT-7005	215	YT-6113	162	YT-6189	185	YT-6239	186	YT-6402	140	YT-65049	141	YT-7007	216
YT-55451	284			YT-6050	161	YT-6113	162	YT-6189	185	YT-6239	186	YT-6402	140	YT-65049	141	YT-7007	216	YT-61132	162	YT-6190	185	YT-6241	133	YT-6403	140	YT-6505	141	YT-7011	216
YT-55453	284	YT-5911	354	YT-6052	161	YT-61132	162	YT-6190	185	YT-6241	133	YT-6403	140	YT-6505	141	YT-7011	216	YT-6114	162	YT-6191	185	YT-6242	133	YT-6404	140	YT-6506	141	YT-7022	216
YT-55455	282	YT-5913	354	YT-60522	161	YT-6114	162	YT-6191	185	YT-6242	133	YT-6404	140	YT-6506	141	YT-7022	216	YT-6116	162	YT-6192	185	YT-6243	133	YT-6405	140	YT-6510	141; 205	YT-7023	216
YT-55456	280	YT-5914	354	YT-6053	161	YT-6116	162	YT-6192	185	YT-6243	133	YT-6405	140	YT-6510	141; 205	YT-7023	216	YT-6117	162	YT-6193	185	YT-6244	133	YT-6406	140	YT-6511	141; 205	YT-7024	216
YT-55457	284	YT-59160	163	YT-60533	161	YT-6117	162	YT-6193	185	YT-6244	133	YT-6406	140	YT-6511	141; 205	YT-7024	216	YT-6120	162	YT-6194	185	YT-6245	133	YT-6407	140	YT-6512	141; 205	YT-7025	216
YT-55458	283	YT-59161	163	YT-6055	161	YT-6120	162	YT-6194	185	YT-6245	133	YT-6407	140	YT-6512	141; 205	YT-7025	216	YT-6121	162	YT-6199	189	YT-6246	133	YT-6408	140	YT-6513	141; 205	YT-7026	216
YT-55462	283	YT-59163	163	YT-6056	161	YT-6121	162	YT-6199	189	YT-6246	133	YT-6408	140	YT-6513	141; 205	YT-7026	216	YT-6122	162	YT-6220	189	YT-6247	133	YT-6409	140	YT-6581	96	YT-7032	216
YT-55463	281	YT-59164	163	YT-6057	161	YT-6122	162	YT-6220	189	YT-6247	133	YT-6409	140	YT-6581	96	YT-7032	216	YT-6124	162	YT-6221	189	YT-6248	133	YT-6410	140	YT-6582	96	YT-7033	216
YT-55464	282	YT-59165	163	YT-6058	161	YT-6124	162	YT-6221	189	YT-6248	133	YT-6410	140	YT-6582	96	YT-7033	216	YT-6125	162	YT-6222	189	YT-6249	133	YT-64111	140	YT-6583	96	YT-7034	216
YT-55465	285	YT-59166	163	YT-60582	161	YT-6125	162	YT-6222	189	YT-6249	133	YT-64111	140	YT-6583	96	YT-7034	216	YT-6126	162	YT-62228	185	YT-6251	133	YT-64112	140	YT-6600	96	YT-7051	216
YT-55466	285	YT-59167	163	YT-60583	161	YT-6126	162	YT-62228	185	YT-6251	133	YT-64112	140	YT-6600	96	YT-7051	216	YT-6128	162	YT-62229	185	YT-6253	133	YT-64113	140	YT-6601	96	YT-7052	216
YT-55469	282	YT-59168	163	YT-6060	161	YT-6128	162	YT-62229	185	YT-6253	133	YT-64113	140	YT-6601	96	YT-7052	216	YT-6129	162	YT-6223	185	YT-6256	133	YT-6412	140	YT-6602	96	YT-7053	216
YT-55471	285	YT-59169	163	YT-6061	161	YT-6129	162	YT-6223	185	YT-6256	133	YT-6412	140	YT-6602	96	YT-7053	216	YT-6131	162	YT-62231	185	YT-6258	133	YT-6413	140	YT-6610	96	YT-7054	216
YT-55472	281	YT-59170	163	YT-6062	161	YT-6131	162	YT-62231	185	YT-6258	133	YT-6413	140	YT-6610	96	YT-7054	216	YT-6132	162	YT-62238	185	YT-6260	133	YT-6414	140	YT-6611	96	YT-7055	216
YT-55473	281	YT-59171	163	YT-6063	161	YT-6132	162	YT-62238	185	YT-6260	133	YT-6414	140	YT-6611	96	YT-7055	216	YT-6133	162	YT-62239	185	YT-6280	133	YT-6415	140	YT-6612	96	YT-7070	244
YT-55474	284	YT-59172	163	YT-60633	161	YT-6133	162	YT-62239	185	YT-6280	133	YT-6415	140	YT-6612	96	YT-7070	244	YT-6136	162	YT-6224	185	YT-6281	133	YT-6416	140	YT-6740	218	YT-7071	244
YT-55476	285	YT-59173	163	YT-60634	161	YT-6136	162	YT-6224	185	YT-6281	133	YT-6416	140	YT-6740	218	YT-7071	244	YT-6137	162	YT-62241	185	YT-6330	175	YT-6417	140	YT-6741	218	YT-7080	244
YT-55477	285	YT-59174	163	YT-6065	161	YT-6137	162	YT-62241	185	YT-6330	175	YT-6417	140	YT-6741	218	YT-7080	244	YT-6138	162	YT-62243	185	YT-6331	175	YT-6420	141	YT-6742	218	YT-7081	244
YT-55478	285	YT-59175	163	YT-60652	161	YT-6138	162	YT-62243	185	YT-6331	175	YT-6420	141	YT-6742	218	YT-7081	244	YT-6140	187	YT-62244	185	YT-6332	175	YT-6421	141	YT-6743	218	YT-7082	244
YT-55479	286	YT-5917																											

YATO	page/ strona	YATO	page/ strona	YATO	page/ strona	YATO	page/ strona	YATO	page/ strona	YATO	page/ strona	YATO	page/ strona	YATO	page/ strona		
YT-7128	243	YT-7365	424	YT-7470	426	YT-76051	178	YT-7980	83	YT-80382	433	YT-80588	430	YT-80860	431	YT-81841	439
YT-7129	243	YT-7366	424	YT-7471	426	YT-76052	178	YT-8001	136; 467	YT-80383	433	YT-80589	430	YT-8100	236; 451	YT-81842	439
YT-7130	243	YT-7367	424	YT-7472	426	YT-76060	179	YT-8002	136; 467	YT-80384	433	YT-80590	430	YT-8101	236; 451	YT-81843	439
YT-7131	243	YT-7368	424	YT-7473	426	YT-76061	179	YT-8003	136; 467	YT-80390	432	YT-80591	430	YT-8102	236; 451	YT-81844	440
YT-71540	244	YT-7369	424	YT-7474	426	YT-7620	234	YT-8004	136; 467	YT-80391	432	YT-80733	431	YT-81021	236; 451	YT-81845	440
YT-71541	244	YT-73700	425	YT-7480	426	YT-7623	235	YT-8005	136; 467	YT-80392	432	YT-80734	431	YT-81022	236; 451	YT-81846	440
YT-71570	244	YT-73701	425	YT-7481	426	YT-7624	235	YT-8006	136; 467	YT-80393	432	YT-80735	431	YT-81023	236; 451	YT-81847	440
YT-71571	244	YT-7371	424	YT-7485	427	YT-76260	229	YT-8011	136; 467	YT-80394	432	YT-80736	431	YT-81024	236; 451	YT-81848	440
YT-71572	244	YT-7374	424	YT-74852	427	YT-7751	57	YT-8012	136; 467	YT-80435	433	YT-80737	431	YT-81052	236; 451	YT-81849	440
YT-71580	244	YT-73744	424	YT-7486	427	YT-7752	57	YT-80130	136	YT-80436	433	YT-80738	431	YT-81053	236; 451	YT-81855	444
YT-71581	244	YT-7376	424	YT-74862	427	YT-7753	57	YT-8020	433	YT-80437	433	YT-80739	431	YT-81054	236; 451	YT-81856	444
YT-71582	244	YT-73760	424	YT-74870	427	YT-7807	83	YT-8021	433	YT-80438	433	YT-80740	431	YT-8106	236; 451	YT-81860	444
YT-7200	245	YT-73761	424	YT-7488	427	YT-7808	83	YT-8022	433	YT-80439	433	YT-80741	431	YT-8107	236; 451	YT-81880	445
YT-72003	245	YT-73765	425	YT-74916	428	YT-7809	83	YT-8023	433	YT-80460	430	YT-80761	431	YT-8108	236; 451	YT-81900	441
YT-72004	245	YT-73766	425	YT-74917	428	YT-7810	83	YT-8024	433	YT-80461	430	YT-80762	431	YT-8111	236; 451	YT-81901	441
YT-7201	245	YT-7377	425	YT-74919	428	YT-7811	83	YT-8025	434	YT-80462	430	YT-80763	431	YT-8112	236; 451	YT-81902	441
YT-7220	248	YT-7380	425	YT-7492	428	YT-7812	83	YT-8026	434	YT-80463	430	YT-80764	431	YT-8116	236; 451	YT-81903	441
YT-7221	248	YT-73801	425	YT-74949	428	YT-7813	83	YT-8027	434	YT-80464	430	YT-80765	431	YT-81162	236; 451	YT-81904	441
YT-7222	248	YT-7381	425	YT-75001	180	YT-78130	82	YT-8028	434	YT-80465	430	YT-80766	431	YT-8120	236; 451	YT-81941	438
YT-7223	248	YT-7382	425	YT-7504	180	YT-78131	82	YT-80280	433	YT-80466	430	YT-80767	431	YT-81490	351	YT-81943	438
YT-72300	245	YT-7383	425	YT-7505	180	YT-78132	82	YT-80281	433	YT-80467	430	YT-80768	431	YT-81491	351	YT-81947	438
YT-72301	245	YT-73830	425	YT-7506	180	YT-78133	82	YT-80282	433	YT-80468	430	YT-80769	431	YT-8152	125	YT-81948	438
YT-72302	245	YT-73921	370	YT-7507	180	YT-78134	82	YT-80283	433	YT-80469	430	YT-80783	431	YT-8156	125	YT-81951	438
YT-72303	245	YT-73924	370	YT-75071	180	YT-78135	82	YT-80284	433	YT-80470	430	YT-80784	431	YT-8159	125	YT-81952	438
YT-72305	245	YT-7400	418	YT-75072	180	YT-78136	82	YT-80285	434	YT-80471	430	YT-80785	431	YT-81591	125	YT-81960	439
YT-7300	322	YT-7409	418	YT-75101	180	YT-78141	82	YT-80286	434	YT-80521	430	YT-80786	431	YT-81592	125	YT-81961	439
YT-7301	322	YT-7410	418	YT-7511	180	YT-78142	82	YT-80287	434	YT-80522	430	YT-80787	431	YT-81593	125	YT-81962	439
YT-7302	322	YT-7413	418	YT-7512	180	YT-78143	82	YT-80288	434	YT-80523	430	YT-80788	431	YT-81594	125	YT-82034	394
YT-73030	321	YT-7414	418	YT-75121	180	YT-78144	82	YT-80289	434	YT-80524	430	YT-80789	431	YT-81595	125	YT-82035	394
YT-7306	322	YT-7416	418	YT-75122	180	YT-78145	82	YT-8029	434	YT-80525	430	YT-80790	431	YT-8165	125	YT-82036	394
YT-7307	321	YT-7417	418	YT-75140	181	YT-78146	82	YT-80290	434	YT-80526	430	YT-80791	431	YT-81651	125	YT-82037	395
YT-73080	123; 242	YT-7419	419	YT-7520	179	YT-78147	82	YT-80291	434	YT-80527	430	YT-80794	431	YT-81652	125	YT-82044	395
YT-73084	123; 242	YT-7420	419	YT-75201	179	YT-7815	83	YT-80292	434	YT-80528	430	YT-80795	431	YT-81654	125	YT-82050	395
YT-73086	123; 242	YT-7430	419	YT-7524	180	YT-78150	82	YT-80293	434	YT-80529	430	YT-80796	431	YT-81655	125	YT-82051	395
YT-73087	123; 242	YT-7433	419	YT-7525	180	YT-78151	82	YT-80294	434	YT-80552	430	YT-80797	431	YT-8166	125	YT-82070	395
YT-73091	123; 242	YT-7435	420	YT-7527	180	YT-78152	82	YT-8030	434	YT-80553	430	YT-80798	431	YT-8173	125	YT-82091	393
YT-7310	324	YT-74351	419	YT-7528	180	YT-78153	82	YT-8031	434	YT-80554	430	YT-80799	431	YT-8174	125	YT-82094	393
YT-7311	324	YT-74360	419	YT-7529	180	YT-78154	82	YT-8032	434	YT-80555	430	YT-80800	431	YT-8177	125	YT-82100	393
YT-7312	324	YT-74361	419	YT-7530	180	YT-78155	82	YT-8033	434	YT-80556	430	YT-80801	431	YT-81775	441	YT-82103	393
YT-73124	246	YT-74370	420	YT-7531	180	YT-78156	82	YT-8034	434	YT-80557	430	YT-80802	431	YT-81788	443	YT-82120	395
YT-73125	246	YT-74371	420	YT-7532	179	YT-78160	82	YT-80355	432	YT-80558	430	YT-80841	431	YT-81789	443	YT-82125	396
YT-73126	246	YT-74372	420	YT-7534	179	YT-78161	82	YT-80356	432	YT-80559	430	YT-80842	431	YT-81797	441	YT-82127	396
YT-73127	246	YT-74373	420	YT-7550	185	YT-78162	82	YT-80357	432	YT-80560	430	YT-80843	431	YT-81798	442	YT-82130	396
YT-73131	122; 246	YT-7446	420	YT-7551	185	YT-78163	82	YT-80358	432	YT-80572	430	YT-80844	431	YT-81799	443	YT-82135	396
YT-7320	310	YT-7451	429	YT-7560	181	YT-78164	82	YT-80359	432	YT-80573	430	YT-80845	431	YT-81800	441	YT-82140	397
YT-7349	345	YT-74510	429	YT-7561	181	YT-78165	82	YT-80360	432	YT-80574	430	YT-80846	431	YT-81801	442	YT-82150	396
YT-7350	345	YT-7453	429	YT-7581	180	YT-78166	82	YT-80361	432	YT-80575	430	YT-80847	431	YT-81802	443	YT-82153	396
YT-7352	345	YT-7454	429	YT-75811	180	YT-78167	82	YT-80362	432	YT-80576	430	YT-80848	431	YT-81803	442	YT-82171	397
YT-7360	424	YT-7455	429	YT-7600	121; 177	YT-78190	82	YT-80363	432	YT-80577	430	YT-80849	431	YT-81804	442	YT-82180	394
YT-73602	425	YT-7456	429	YT-7601	121; 177	YT-78191	82	YT-80364	432	YT-80578	430	YT-80852	431	YT-81806	442	YT-82190	235; 399
YT-73603	425	YT-7458	429	YT-76030	178	YT-78192	82	YT-80365	432	YT-80579	430	YT-80853	431	YT-81807	442	YT-82195	393
YT-7361	424	YT-7459	429	YT-76031	178	YT-78193	82	YT-80366	432	YT-80580	430	YT-80854	431	YT-81810	443	YT-82220	398
YT-7362	424	YT-7460	426	YT-76040	178	YT-78194	82	YT-80367	432	YT-80583	430	YT-80855	431	YT-81812	337; 444	YT-82223	399
YT-7363	424	YT-7461	426	YT-76041	178	YT-7848	83	YT-80368	432	YT-80584	430	YT-80856	431	YT-81820	337; 444	YT-82230	398
YT-73631	424	YT-7462	429	YT-76042	179	YT-7881	83	YT-80369	432	YT-80585	430	YT-80857	431	YT-81834	440	YT-82250	205; 402
YT-7364	424	YT-74621	429	YT-76043	179	YT-7882	83	YT-80380	433	YT-80586	430	YT-80858	431	YT-81835	440	YT-82270	397
YT-73641	424	YT-7463	429	YT-76050	178	YT-7883	83	YT-80381	433	YT-80587	430	YT-80859	431	YT-81840	439	YT-82272	397

YATO	page/strona	YATO	page/strona	YATO	page/strona	YATO	page/strona	YATO	page/strona	YATO	page/strona	YATO	page/strona	YATO	page/strona		
YT-82280	397	YT-82822	390	YT-83160	191	YT-83274	193	YT-83433	194	YT-8367	190	YT-8481	191	YT-86809	469	YT-8959	457
YT-82288	399	YT-82823	390	YT-83161	191	YT-83275	193	YT-83434	194	YT-8368	190	YT-8482	191	YT-8790	463	YT-8960	458
YT-82291	399	YT-82826	391	YT-83162	191	YT-83276	193	YT-83435	194	YT-8370	190	YT-8483	191	YT-8791	463	YT-8962	459
YT-82292	400	YT-82827	391	YT-83163	191	YT-83291	193	YT-83436	194	YT-8371	190	YT-8484	191	YT-8800	462	YT-8963	457
YT-82293	400	YT-82830	391; 406; 471	YT-83164	191	YT-83292	193	YT-83437	194	YT-8372	190	YT-8485	191	YT-8801	462	YT-8964	457
YT-82340	398			YT-83165	191	YT-83293	193	YT-83438	194	YT-8373	190	YT-8486	191	YT-8802	462	YT-8965	456
YT-82401	123; 221; 402	YT-82831	391; 406; 471	YT-83166	191	YT-83294	193	YT-83440	194	YT-8374	190	YT-84900	408; 474	YT-8805	462	YT-8966	456
				YT-83167	191	YT-83295	193	YT-83441	194	YT-8375	190	YT-84905	409; 474	YT-8807	462	YT-8967	457
YT-82402	123; 221; 402	YT-82832	391; 406; 472	YT-83168	191	YT-83296	193	YT-83442	194	YT-8376	190	YT-84920	408; 473	YT-8808	462	YT-8968	458
				YT-83169	191	YT-83351	193	YT-83443	194	YT-8377	190	YT-84930	410; 475	YT-8809	462	YT-8970	454
YT-82430	221	YT-82833	391; 406; 472	YT-83180	192	YT-83352	193	YT-83444	194	YT-8378	190	YT-84931	410; 475	YT-8811	462	YT-8971	454
YT-82431	221			YT-83181	192	YT-83353	193	YT-83445	194	YT-8400	191	YT-84932	410; 476	YT-8815	463	YT-8972	454
YT-82433	221	YT-82834	392; 407; 472	YT-83182	192	YT-83354	193	YT-83446	194	YT-8401	191	YT-84933	410; 476	YT-8816	463	YT-8973	455
YT-82434	221			YT-83183	192	YT-83355	193	YT-83447	194	YT-8402	191	YT-84934	410; 476	YT-8817	463	YT-8974	455
YT-82435	221	YT-82835	392; 407; 472	YT-83184	192	YT-83356	193	YT-83448	194	YT-8403	191	YT-84935	411; 476	YT-8821	466	YT-8975	455
YT-82436	221			YT-83185	192	YT-83361	193	YT-83451	194	YT-8404	191	YT-84936	411; 476	YT-8822	466	YT-8976	455
YT-82437	221	YT-82836	392; 405; 470	YT-83186	192	YT-83362	193	YT-83452	194	YT-8405	191	YT-84940	411; 477	YT-8823	466	YT-8977	455
YT-82438	221			YT-83187	192	YT-83363	193	YT-83453	194	YT-8406	191	YT-84941	411; 477	YT-8824	466	YT-8978	455
YT-82439	221	YT-82837	392; 405; 471	YT-83188	192	YT-83364	193	YT-83454	194	YT-8407	191	YT-84942	411; 477	YT-8831	464	YT-8979	454
YT-8245	124; 220; 401			YT-83189	192	YT-83365	193	YT-83455	194	YT-8408	191	YT-84943	412; 477	YT-8832	464	YT-8984	460
	YT-82842	392; 407; 473	YT-83190	192	YT-83366	193	YT-83456	194	YT-8409	191	YT-84944	412; 477	YT-8833	464	YT-8985	459	
YT-82451			124; 220; 401			YT-83200	192	YT-83371	193	YT-83457	194	YT-8410	191	YT-84945	412; 477	YT-8834	464
	YT-82843	392; 407; 473	YT-83201	192	YT-83372	193	YT-83458	194	YT-8411	191	YT-84950	412; 478	YT-8835	464	YT-8987	459	
YT-82455			124; 220; 402			YT-83202	192	YT-83373	193	YT-83480	194	YT-8412	191	YT-84951	412; 478	YT-8836	464
	YT-82844	392; 407; 473	YT-83203	192	YT-83374	193	YT-83481	194	YT-8413	191	YT-84953	412; 478	YT-8838	464	YT-8993	460	
YT-8271			124; 220; 401			YT-83204	192	YT-83375	193	YT-83482	194	YT-8414	191	YT-84954	413; 478	YT-8839	465
	YT-82848	392; 407; 473	YT-83205	192	YT-83376	193	YT-83483	194	YT-8415	191	YT-84955	413; 478	YT-8840	465	YT-9940	455	
YT-8272			124; 220; 401			YT-83206	192	YT-83381	193	YT-83484	194	YT-8416	191	YT-84960	413; 478	YT-8841	465
	YT-82857	389	YT-83207	192	YT-83382	193	YT-83485	194	YT-8417	191	YT-84961	413; 479	YT-8842	465	YT-99801	454	
YT-8273	124; 220; 401	YT-82861	389	YT-83208	192	YT-83383	193	YT-83486	194	YT-8418	191	YT-84962	413; 479	YT-8843	463	YT-99802	454
		YT-82900	389; 398	YT-83209	192	YT-83384	193	YT-83487	194	YT-8440	190	YT-84963	413; 479	YT-8845	463	YT-99803	454
YT-82742	124; 220	YT-82930	255; 387	YT-83210	192	YT-83385	193	YT-83488	194	YT-8441	190	YT-84970	414; 479	YT-8849	463	YT-99804	454
YT-82743	124; 220	YT-82931	255; 387	YT-83211	192	YT-83386	193	YT-83490	194	YT-8442	190	YT-84971	414; 479	YT-8851	466	YT-99810	454
YT-82744	124; 220	YT-82932	256; 387	YT-83220	192	YT-83390	193	YT-83491	194	YT-8443	190	YT-85000	409; 475	YT-8852	466	YT-99811	454
YT-82760	387	YT-8300	349	YT-83221	192	YT-83391	193	YT-83492	194	YT-8444	190	YT-85002	409; 475	YT-8853	466	YT-99812	454
YT-82780	383	YT-8301	349	YT-83222	192	YT-83392	193	YT-83493	194	YT-8445	190	YT-85021	409; 475	YT-8854	466	YT-99813	454
YT-82781	383	YT-83016	349	YT-83223	192	YT-83393	193	YT-83494	194	YT-8446	190	YT-85080	404; 470	YT-8865	468	YT-99814	455
YT-82782	383	YT-8302	350	YT-83224	192	YT-83394	193	YT-83495	194	YT-8447	190	YT-85090	404; 470	YT-8866	468	YT-99815	455
YT-82783	383	YT-8303	350	YT-83225	192	YT-83395	193	YT-83496	194	YT-8448	190	YT-85100	406; 472	YT-8867	468	YT-99830	456
YT-82786	384	YT-83031	349	YT-83226	192	YT-83396	193	YT-83497	194	YT-8449	190	YT-85110	405; 471	YT-8868	468	YT-99841	458
YT-82787	384	YT-83032	349	YT-83227	192	YT-83397	193	YT-83498	194	YT-8450	190	YT-85120	405; 470	YT-8869	468	YT-99845	460
YT-82788	384	YT-83033	349	YT-83228	192	YT-83398	193	YT-8350	190	YT-8451	190	YT-85130	407; 473	YT-8870	468	YT-99848	455
YT-82789	384	YT-8304	350	YT-83229	192	YT-83399	193	YT-8351	190	YT-8452	190	YT-85131	407; 473	YT-8876	465	YT-99850	461
YT-82794	385	YT-8305	350	YT-83230	192	YT-83400	193	YT-8352	190	YT-8453	190	YT-85132	404; 470	YT-8885	468	YT-99852	461
YT-82795	385	YT-83051	350	YT-83231	192	YT-83401	193	YT-8353	190	YT-8454	190	YT-85133	404; 470	YT-8886	468	YT-99853	461
YT-82796	385	YT-83052	350	YT-83232	192	YT-83420	194	YT-8354	190	YT-8455	190	YT-85140	408; 473	YT-8889	468		
YT-82797	385	YT-83060	351	YT-83233	192	YT-83421	194	YT-8355	190	YT-8456	190	YT-85350	404; 461	YT-8890	468		
YT-82800	386	YT-83061	351	YT-83234	192	YT-83422	194	YT-8356	190	YT-8457	190	YT-85401	403	YT-8891	468		
YT-82801	386	YT-83062	351	YT-83235	192	YT-83423	194	YT-8357	190	YT-8458	190	YT-85402	403	YT-8892	468		
YT-82804	386	YT-83080	351	YT-83236	192	YT-83424	194	YT-8358	190	YT-8459	190	YT-85403	403	YT-8894	469		
YT-82805	386	YT-83081	351	YT-83237	192	YT-83425	194	YT-8360	190	YT-8460	190	YT-85434	403	YT-8940	458		
YT-82810	388	YT-8310	242; 352	YT-83238	192	YT-83426	194	YT-8361	190	YT-8461	190	YT-85437	403	YT-8941	458		
YT-82811	388	YT-83101	242; 352	YT-83239	192	YT-83427	194	YT-8362	190	YT-8462	190	YT-86800	469	YT-8950	456		
YT-82814	388	YT-8311	242; 352	YT-83240	192	YT-83428	194	YT-8363	190	YT-8463	190	YT-86801	469	YT-8955	456		
YT-82815	388	YT-83151	352	YT-83271	193	YT-83430	194	YT-8364	190	YT-8464	190	YT-86804	469	YT-8956	456		
YT-82818	389	YT-83152	352	YT-83272	193	YT-83431	194	YT-8365	190	YT-8465	190	YT-86805	469	YT-8957	457		
YT-82819	390	YT-83153	352	YT-83273	193	YT-83432	194	YT-8366	190	YT-8466	190	YT-86808	469	YT-8958	457		



MANUFACTURER / PRODUCENT

TOYA S.A.
ul. Sołtysowicka 13-15
51-168 Wrocław
Poland
☎ (+48 71) 32 46 200
fax: (+48 71) 32 46 370
sales@yato.pl (domestic)
export@yato.pl (export)
import@yato.pl (import)

ODDZIAŁ WARSZAWSKI
Teren ProLogis Park Nadarzyn
al. Kasztanowa 160
05-831 Młochów k. Warszawy
Poland
☎ (+48 22) 73 82 800
☎ (+48 22) 73 82 828
sales@yato.pl (domestic)
export@yato.pl (export)

TOYA ROMANIA S.A.
Sos. Odăi Nr. 109-123
Sector 1, București
☎ (+40 031) 710 8692
office@yato.ro

YATO TOOLS (Shanghai) Co., Ltd.
No. 8, Lane 1300, East Kangqiao
Road Shanghai, China 201315
☎ (+86 21) 681 829 50
fax: (+86 21) 681 829 51
yato@yato-sh.com

YOUR TRUSTED SUPPLIER: / TWÓJ ZAUFANY DOSTAWCA:

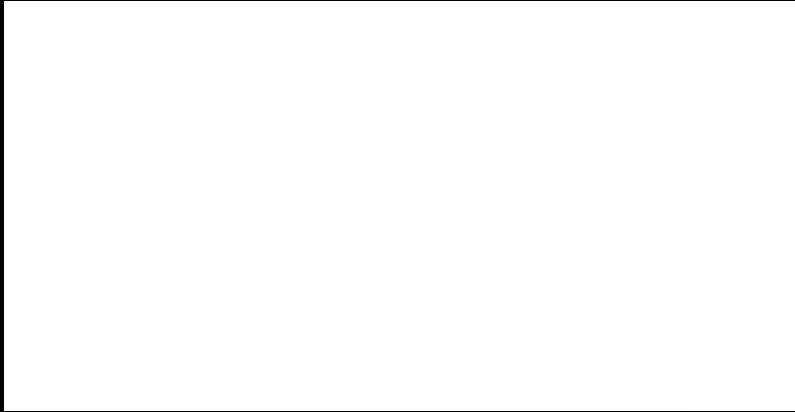

www.yato.com

**GET ACQUAINTED WITH OUR WIDE OFFER:
ZOBACZ NASZĄ BOGATĄ OFERTĘ:**

