

2018



CATALOG

PRODUSE INDEX

TRUSE DE CHEI ȘI SCULE

5



TRUSE / CHEI / GHIDURI NAVELOR / JUEGOS DE PUNTAS / SET CAPETE TUBULARE / ÎNALTĂ TENSIUNE

UNELTE MANUALE

32



CLICHETE / PRELUNGITOARE / BARĂ "T" DE FORȚĂ / ȘURUBELNIȚE / ÎNDOIT TUBURI / TĂIEREA TUBURILOR / CLEȘTE / CUTITE / ADAPTOARE / SET DE CHEI / CHEIE ȚEVI STILLSON / CIOCANE / FERĂȘTRAIE / PILE / POANSOANE / DALȚĂ / SCARPS / RIVETERS / TASTELE DE TRAVERSĂ

MOBILIER

57



CĂRUCIOARE CU SCULE / DULAPURI / MODULE PENTRU CĂRUCIOARE / TABLE PERFORATE PANOURI / CÂRLIGE PENTRU PERETE / MESE DE LUCRU / NICOVALE / ȘURUBURILE DE BANCA / CUTII PENTRU SCULE / TĂRGI / SUPORTURI SUSȚINERE CAROSERII / SCAUNE / BANCHETE / ACCESORII

ILUMINARE

71



LAMPI BUZUNAR / LANTERNE PORTABILE / GIROFARURI / PROIECTOARE PĂTRATE / PENTRU VEICULE LAMPI

INSTRUMENTE PNEUMATICE

87



PISTOALE DE IMPACT / PISTOALE DE AER / FILTRELOR DE PARTICULE / CLICHEȚI / FERĂȘTRAIE / POLIZOARE / MAȘINI DE GĂURIT / MAȘINI DE ȘLEFUIT / KITURI MAȘINĂ / TRUSE PISTOL IMPACT + CLICHET PNEUMATIC

UTILE DE IMPACT

102



TUBULARE DE IMPACT / CAPETE DE IMPACT / ADAPTOARE / BĂRI DE PRELUNGIRE / TUBULARE DE SCHIMB / TUBULARE PENTRU VEICULE GRELE

CAROSERIE

111



VENTUZE / DINTRE CLEME / ACCESORII / CONSUMABILE DE ATELIER / CĂLĂFĂUIT / LEVIERE

UTILAJ

121



VENTUZE / DINTRE CLEME / ACCESORII / CĂLĂFĂTUIT / LEVIERE

KIT DISTRIBUȚIE

160



BLOCAJ PT ARBORELE / UNEALTĂ ALINIARE ARBORE / SET DE CHEI PENTRU TENSOR DISTRIBUȚIE / SET BLOCAJ DISTRIBUȚIE

ACCESORII LUBRIFIANTE

186



COLECTOARE OIL / POMPE MANUAĂ PENTRU EXTRAȚIE ULEI / SERINGI TRANSFER DE ULEI / POMPE DE GRESARE / COLECTOARE DE ULEI / POMPE DE ULEI PNEUMATICĂ / REZERVOARE DE ÎNMAGAZINARE BIDOANE

INSTRUMENTE HIDRAULICE

193



CRICURI HIDRAULICE / CRICURI HIDROPNEUMATICE / CRICURI HIDRAULICE / PURTĂTOARE HIDRAULICE RÔȚI AUTO / PRESE / MACARALE PLIABILE / SUPORȚI PENTRU MOTOR / MESE HIDRAULICE / ELEVATOARE

SCULE ELECTRICE

202



ÎNCĂRCĂTOARE DE BATERII / BORMAȘINI VERTICALE / CABLURI PENTRU REDRESOARE AUTO / TESTERE DE BATERIE / ASPIRATOARE INDUSTRIALE / POLIZOARE ELECTRICE / POLIZOARE ELECTRICE / COMPRESOARE

ACCESORII

210



RULORI / ACCESORII DE ATELIER / ORGANIZATORII / SIGURANȚĂ / KITURI DE URGENȚĂ / SENZORI DE PARCARE / AUTO / ȘTERGĂTOARE DE PARBRIZE / CONTRAGREUȚĂȚI / SETURI REPARAȚIE SUPAPE TPMS / UTILE PENTRU PNEURI / RACORDURI FLEXIBILE

CONSUMABILE

238



CLIPSURI / CONDUCTORI / CHAVETAS / SCREWS ȘI NUTS / RIVETS / SPĂLĂTORI / CLAMPS / O-RINGS / TUBURI DE TERMORETRACTIC / GREASERI / FUSE / TERMINALE / PLASTIC CLIPS

ÎMBRĂCĂMINTE

255



VESTĂ / GEACĂ

PRODUSE PROMOȚIONALE

257



EXPOZANȚII ȘI ACCESORII / PROMOȚIONALI

JBM**JBM, COMPANIA**

JBM este o companie dedicată distribuției de instrumente profesionale.

Suntem un brand spaniol direcționat către industrie și automobile. JBM are, de asemenea, un departament dedicat exclusiv consumatorilor de pe piața de accesorii auto, dotând direct unii producători.

Oferind o gamă completă de peste 5.000 de produse, compania are peste 30 de ani de experiență, exportând produsele noastre în mai mult de 35 de țări din toată lumea.



COMANDA
ON-LINE

www.jbmcamp.com



+2.500
PRODUSE
ÎN CATALOG

+250
PRODUSE
NOI

**JBM**

NUMĂRUL 1
ÎN CALITATE
ȘI PREȚ



CALL CENTER



+34 972 24 55 33
+34 972 40 57 21



jbm@jbmcamp.com



+10.000
EUROPALETI
ÎN STOC

ROTAȚIA
ANUALĂ
x4



NAȚIONALE
ȘI
INTERNAȚIONALE



01



TRUSE DE CHEI ȘI SCULE

- TRUSE DE CHEI ȘI SCULE 6
- SETURI / TRUSE DE TUBULARE. 20
- TRUSE-CAPETE TUBULARE 22
- UNELTE ÎN ȚOLI 24
- TRUSE DE SCULE DIN ALUMINIU 25
- TRUSE CU CLICHET TELESCOPIC 26
- SET TUBULARE 27
- ADAPTOARE 29
- INSTRUMENTE DE ÎNALTĂ TENSIUNE 30



TRUSĂ DE TUBULARE CU 216 PIESE HEXAGONALE

216
PCS



ZINCAT

50895	10,75	2	48
132,00€	Kg		

CROMAT

52840	11,01	2	48
148,00€	Kg		

▶ **PIESE DISPONIBILE**
CONSULTAȚI CATALOGUL DE PIESE

1/2"



1/4"

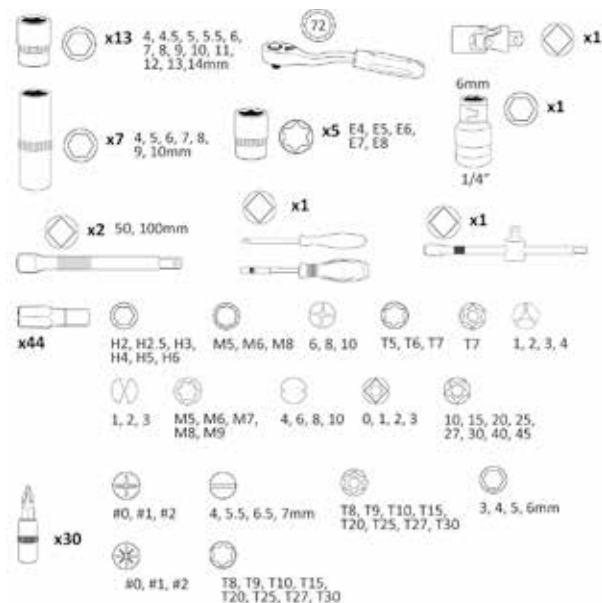

3/8"

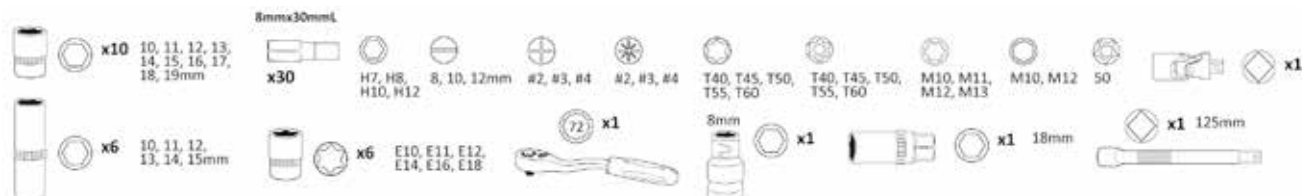

TRUSĂ DE TUBULARE 12 FEȚE CU 113 PIESE

113
PCS



ZINCAT

50791	6,55	3	108
74,00€			

CROMAT

52979	7,06	3	99
79,00€			

▶ **PIESE DISPONIBILE**
CONSULTAȚI CATALOGUL DE PIESE

1/2"

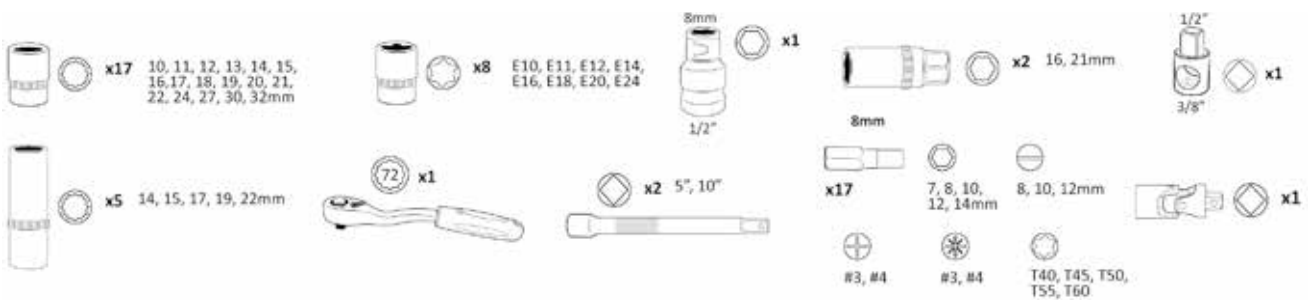

1/4"

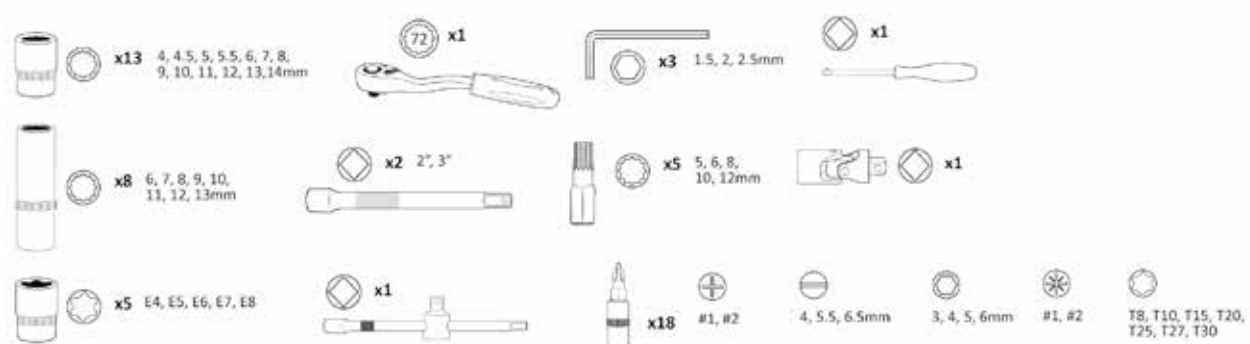

TRUSĂ DE TUBULARE HEXAGONALE CU 108 PIESE

108
PCS



ZINCAT

50521	6,58	3	108
69,00€	Kg		

▶ **PIESE DISPONIBILE
CONSULTAȚI CATALOGUL DE PIESE**

CROMAT

52978	7,00	3	96
78,00€	Kg		

1/2"

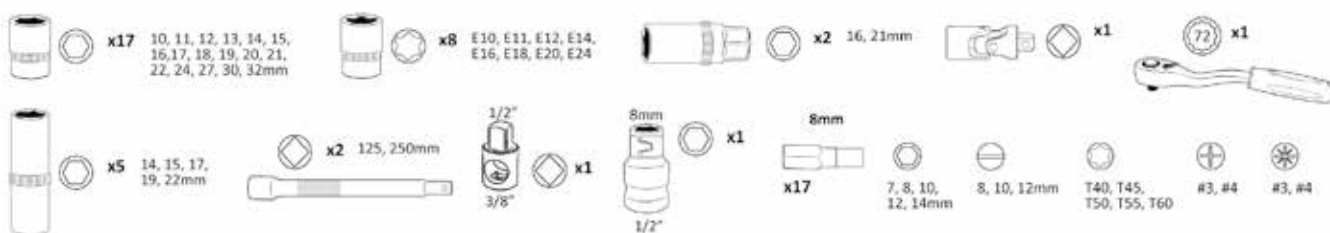

1/4"

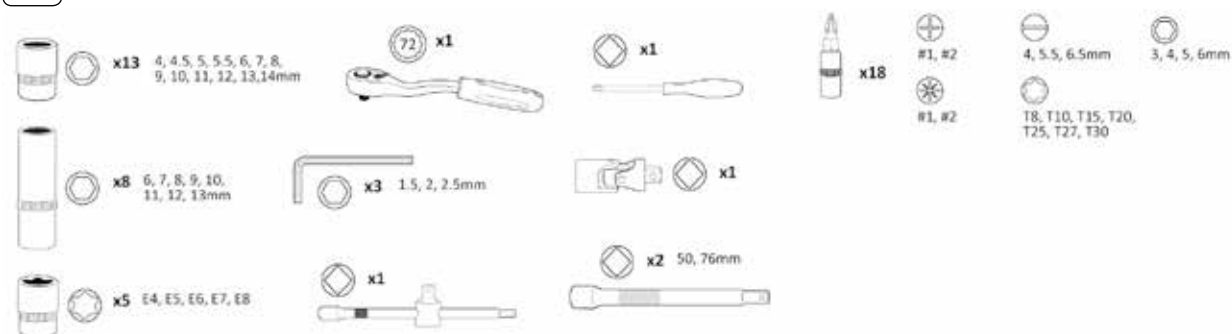

TRUSĂ DE TUBULARE HEXAGONALE CU 94 PIESE

94
PCS



ZINCAT

50437	6,00	3	108
64,00€			

▶ **PIESE DISPONIBILE**
CONSULTAȚI CATALOGUL DE PIESE

CROMAT

53011	6,47	3	108
69,00€			

1/2"

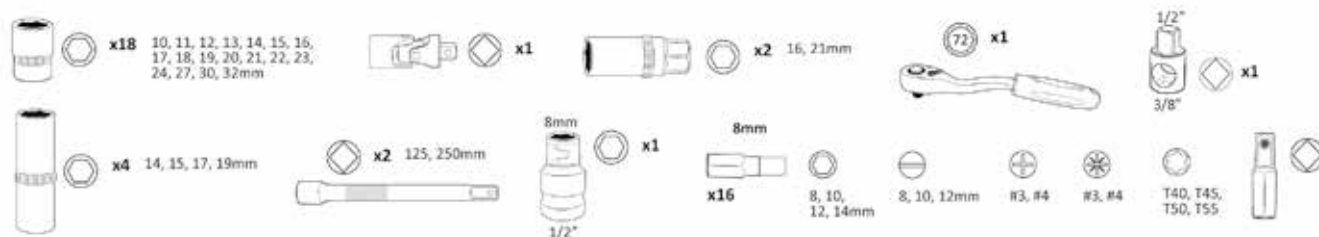

1/4"

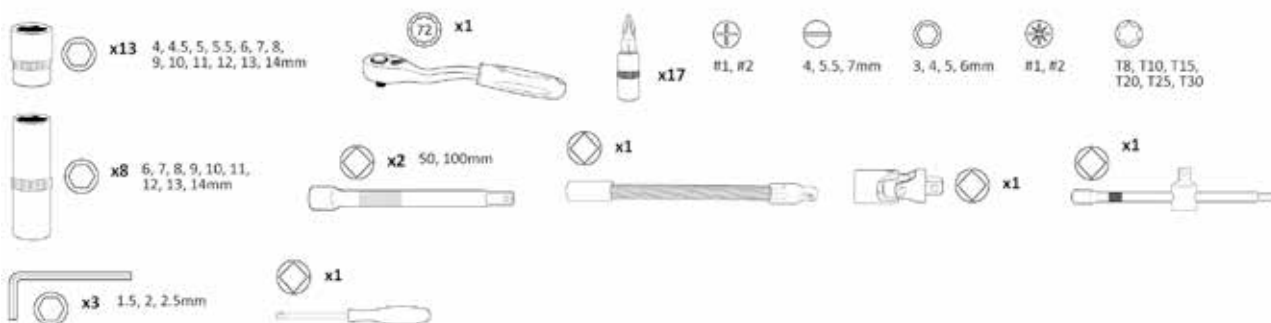

TRUSĂ DE TUBULARE 12 FEȚE DE 3/8" CU 59 PIESE

59
PCS



ZINCAT

51820	2,55	10	180
59,00€			

CROMAT

N 53075	2,57	10	180
60,00€			

3/8"

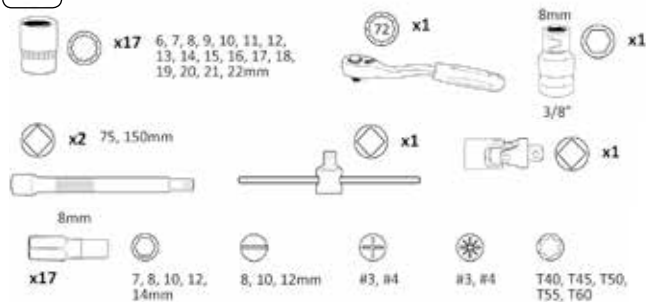

1/4"



➤ **PIESE DISPONIBILE
CONSULTAȚI CATALOGUL DE PIESE**

TRUSĂ DE TUBULARE CU 59 PIESE HEXAGONALE DE 3/8"

59
PCS



➤ **PIESE DISPONIBILE
CONSULTAȚI CATALOGUL
DE PIESE**

ZINCAT

51819	2,55	8	180
56,00€			

N

CROMAT

53219	2,60	10	180
59,00€			



1/4"

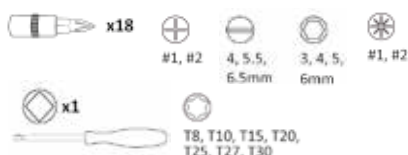

3/8"

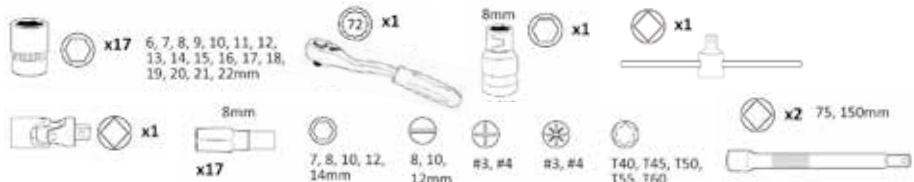

TRUSĂ DE TUBULARE HEXAGONALE CU 56 PIESE



56
PCS

ZINCAT

50566	1,19	20	240
32,00€	Kg	11	11

N

CROMAT

53101	1,26	10	270
33,00€	Kg	11	11



PIESE DISPONIBILE
CONSULTAȚI CATALOGUL
DE PIESE

1/4"

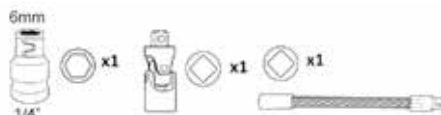
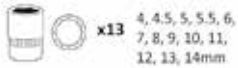

TRUSĂ DE TUBULARE 12 FEȚE CU 56 PIESE



56
PCS

ZINCAT

51892	1,13	10	240
32,00€	Kg	11	11

N

CROMAT

53102	1,28	10	270
34,00€	Kg	11	11



PIESE DISPONIBILE
CONSULTAȚI CATALOGUL
DE PIESE

1/4"

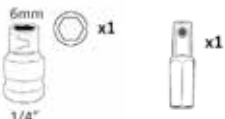
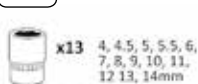

TRUSĂ CHEI TUBULARE SPLINE DE 1/4" CU 36 PIESE

36 PCS



ZINCAT

52720	0,90	10	240
24,00€	Kg	ft	

N
CROMAT

53107	1,07	10	240
27,00€	Kg	ft	

1/4"

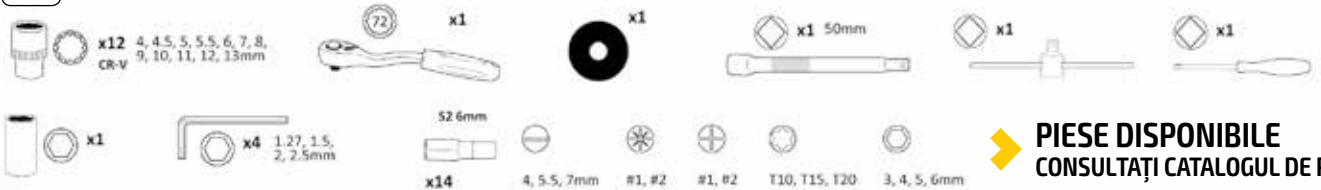

PIESE DISPONIBILE
CONSULTAȚI CATALOGUL DE PIESE

TRUSĂ CHEI TUBULARE SPLINE DE 1/2" ȘI 1/4" CU 61 PIESE

61 PCS



ZINCAT

52722	4,63	4	60
88,00€	Kg	ft	

N

53108	4,83	3	90
89,00€	Kg	ft	

1/2"





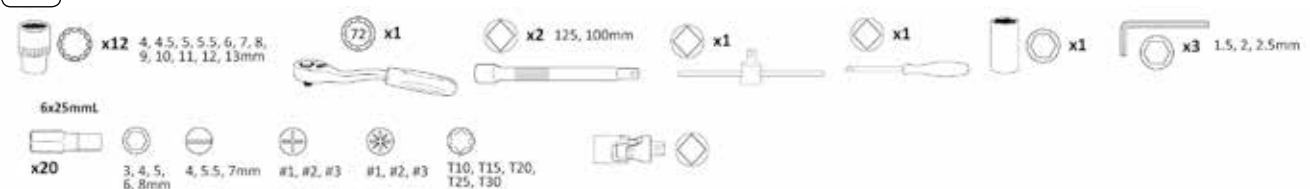

1/4"





TRUSĂ DE TUBULARE HEXAGONALE CU 46 PIESE

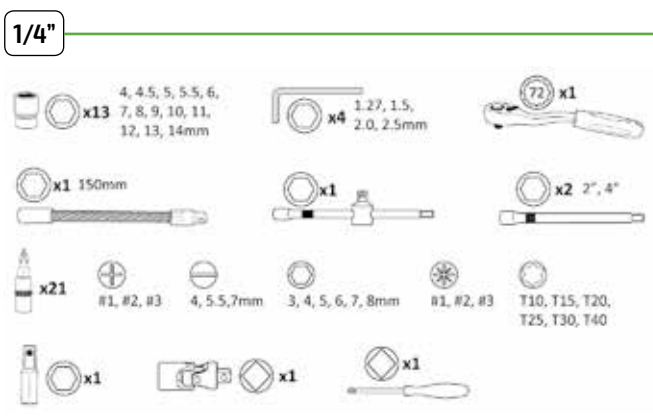

N

53201	1,45	5	10	300		46 PCS
31,65€	Kg					



TRUSĂ DE TUBULARE CU 21 PIESE DE 1/2" SPLINE

52721	3,2	4	120		21 PCS
48,00€	Kg				

52723	3,20	4	96		21 PCS
42,00€	Kg				



TRUSĂ DE TUBULARE 95 PIESE CU 4 SERTARE

51610	11,83	2	20	310mm	485mm	290mm	95 PCS
158,00€	Kg						



Ușor de asamblat
și ...
gata pentru a merge!



SERTAR 1

SERTAR 2

SERTAR 3

SERTAR 4

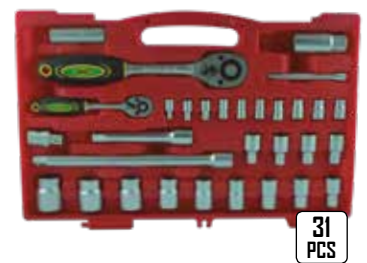

TRUSĂ DE SCULE CU 41 PIESE TUBULARE HEXAGONALE

52713	6,3	4	96		41 PCS
68,00€	Kg				

1/2"

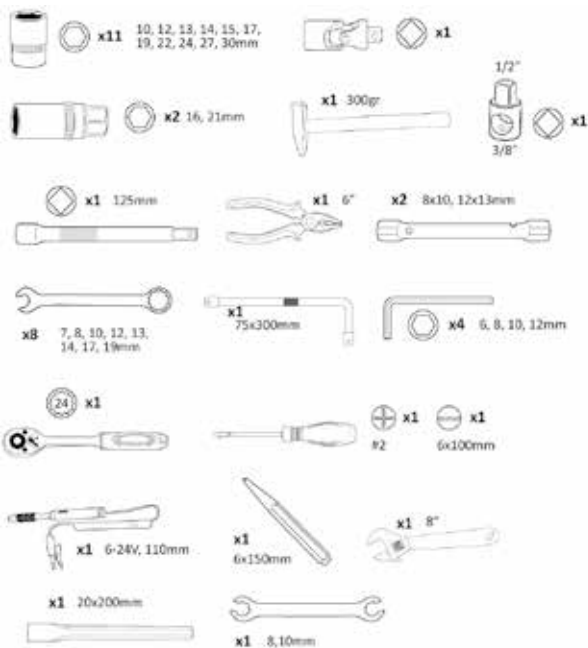

SET DE DUZE HEXAGONALE 303 PIESE

303
PCS



53212	11,35	2	48
148,00€	Kg	11	



- 8x30mmL**
x24
- T25, T27, T30, T35, T40 (x2), T45, T50
 - PH3, PH4
 - P23, P24
 - H5.5, H6.5, H7, H8
 - 5.5, 6.5, 7, 8mm
 - 5, 6, 8, 10mm
- 6.3x25mmL**
x100
- 3, 4, 4.5, 5, 5.5, 6, 6.5, 7, 8mm
 - T8, T10, T15, T20, T25, T27, T30, T35, T40
 - H1.5, H2, H2.5, H3, H4, H5, H5.5, H6, H8
 - 5, 6, 8mm
 - 1, 2, 3, 4
 - 6, 8, 10
 - C1, C2, C3
 - 2, 2.5, 3, 4, 5, 6mm
 - S0, S1, S2, S3
 - 5/64, 3/32, 7/64, 1/8, 9/64, 5/32
 - 4, 6, 8, 10mm
 - PH0 (x2), PH1 (x2), PH2 (x4), PH3 (x2)
 - P20 (x2), P21 (x2), P22 (x4), P23 (x2)
 - 1/16, 5/64, 3/32, 7/64, 1/8, 9/64, 5/32, 3/16, 7/32, 1/4
 - T8, T10, T15, T20, T25, T27, T30, T35, T40, T45

- x4
- 4.0x100mm
 - PH1x80mm
 - 6.5x125mm
 - PH2x100mm

- x5
- 3.0x50mm
 - PH0x50mm
 - 2.5x50mm
 - PH00x50mm
 - PH000x50mm
- x7
- 1.27, 1.5, 2, 2.5, 3, 4, 5mm

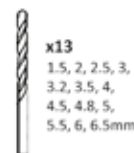
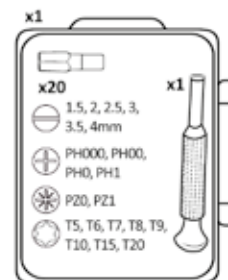
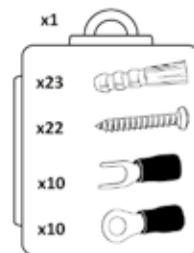
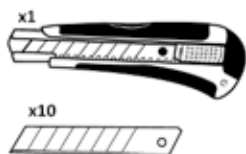
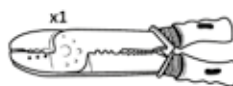

1/2"

- x18
- 10, 11, 12, 13, 14, 15, 16, 17, 18, 19, 20, 21, 22, 23, 24, 27, 30, 32mm
- x1
- x2
- 125, 250mm
- 1/2"
- x1
- 3/8"
- x2
- 16, 21mm
- 8mm
- x1
- x1

1/4"

- x13
- 4, 4.5, 5, 5.5, 6, 7, 8, 9, 10, 11, 12, 14mm
- x1
- x2
- 50, 100mm
- x1
- 6.3mm
- x1
- x1

TRUSĂ DE SCULE CU 72 PIESE TUBULARE HEXAGONALE

72
PCS



ZINCAT

51818	7,25	3	63
78,00€	Kg	1f	1f

▶ **PIESE DISPONIBILE**
CONSULTAȚI CATALOGUL DE PIESE

CROMAT

N	53106	7,20	3	60
	107,70€	Kg	1f	1f

1/2"

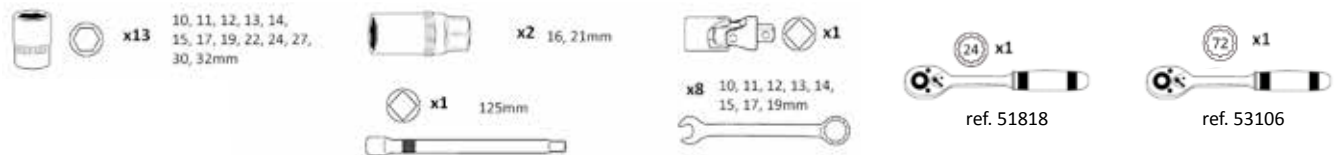

1/4"

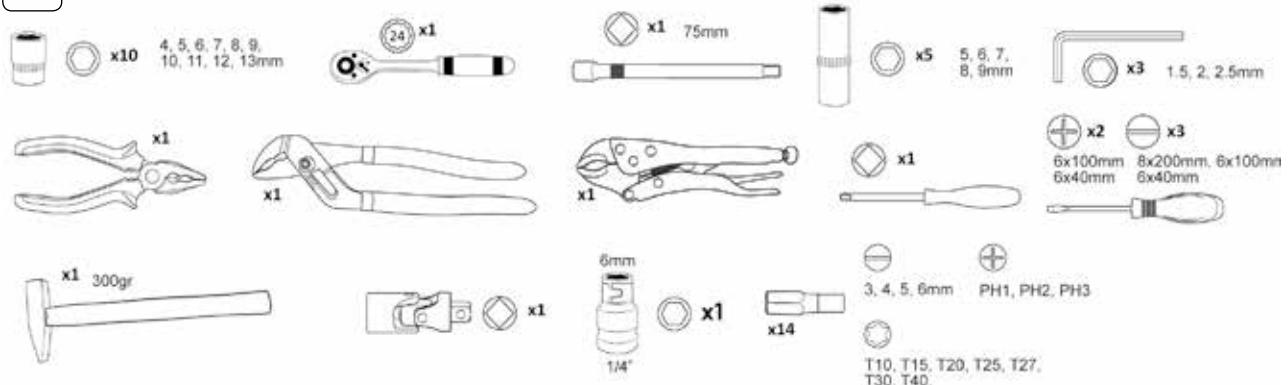

TRUSĂ DE SCULE CU 82 PIESE TUBULARE HEXAGONALE

52712	6,08	3	96
79,00€	Kg	1f	



**82
PCS**



1/2"

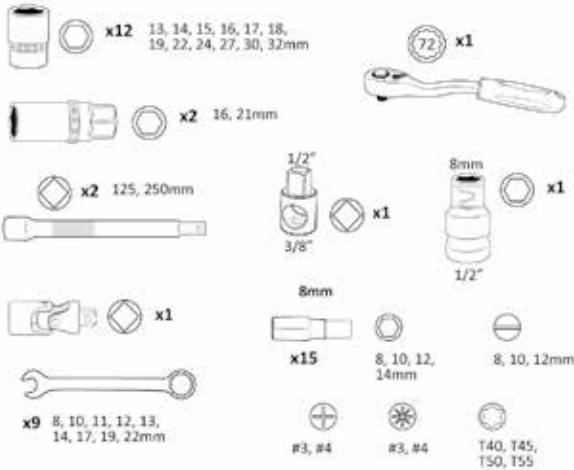

1/4"



➤ **PIESE DISPONIBILE
CONSULTAȚI CATALOGUL DE PIESE**

TRUSĂ CHEI TUBULARE 3/4" CU 22 PIESE HEXAGONALE

53397	14,20	1	40
157,20€	Kg	1f	



3/4"

**22
PCS**

53398	14,50	1	40
157,20€	Kg	1f	



3/4"

**22
PCS**

➤ **PIESE DISPONIBILE
CONSULTAȚI CATALOGUL DE PIESE**

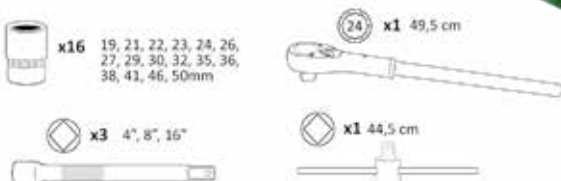

TRUSĂ CHEI TUBULARE HEXAGONALE 1 ȚOL CU 22 PIESE

51616	43,45	1	24
398,00€	Kg		



51855	41,1	1	24
398,00€	Kg		



➤ **PIESE DISPONIBILE**
CONSULTAȚI CATALOGUL DE PIESE

TRUSĂ DE TUBULARE HEX / IMBUS SCURTE CU 39 PIESE

52418	3,61	5	100
144,00€	Kg		



1/4"

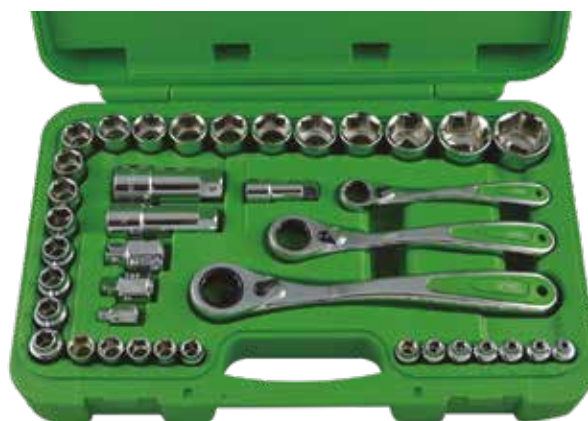
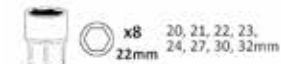
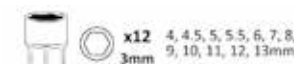

TRUSĂ DE TUBULARE PT. PREZOANE ȘI BARE FILETATE CU 17 PIESE

50623	0,63	10	320
49,00€	Kg		



1/4"



OCUPĂ SPAȚIU MINIM

2,5cm



TRUSĂ DE TUBULARE PT. PREZOANE ȘI BARE FILETATE CU 15 PIESE

51617
55,00€

1,06	18	320
Kg	ff	



1/4"



OCUPĂ SPAȚIU MINIM



SET 28 TUBULARE TORX SCURTE ȘI LUNGI

28 PCS 1/2" 1/4" 3/8"

CROMAT

53061
44,00€

Kg	2,19
ff	3
	180

N



SET DE 12 IMBUSURI TORX 1/2"

12 PCS 1/2"

CROMAT

53103
36,00€

Kg	1,80
ff	10
	330

N



ZINCAT

51930
42,00€

Kg	2,19
ff	10
	240

1/4"

3/8"

1/2"

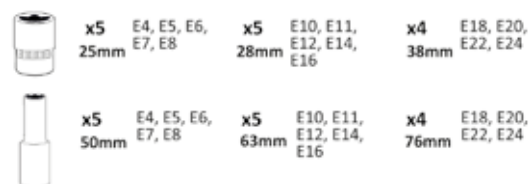

ZINCAT

51261
34,00€

Kg	1,62
ff	10
	390



55mmL: T20, T25, T30, T40, T45, T50
65mmL: T55
70mmL: T60, T70, T80, T90, T100

➤ **PIESE DISPONIBILE
CONSULTAȚI CATALOGUL
DE PIESE**

SET DE 12 IMBUSURI INELARE 1/2"



CROMAT

53104

36,00€

Kg	1,75
ff	10
ff	240

N



SET DE 12 IMBUSURI HEX. 1/2"



CROMAT

53105

36,00€

Kg	2,10
ff	10
ff	240

N



ZINCAT

51384

34,00€

Kg	1,55
ff	10
ff	360



55mmL: M4, M5, M6, M7, M8, M9

65mmL: M10

70mmL: M12, M14, M16, M18, M20

➤ **PIESE DISPONIBILE CONSULTAȚI CATALOGUL DE PIESE**

ZINCAT

51260

34,00€

Kg	1,92
ff	10
ff	390



55mmL: H5, H6, H7, H8, H10, H12

65mmL: H14

70mmL: H16, H17, H18, H19, H22

➤ **PIESE DISPONIBILE CONSULTAȚI CATALOGUL DE PIESE**

SET DE 6 IMBUSURI TORX INVIOLABIL 1/2"

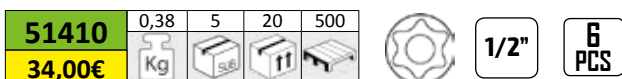

51410

34,00€

0,38	5	20	500
Kg	5	ff	ff



1/2"

6 PCS



T55, T60, T70, T80, T90, T100

SET DE 6 IMBUSURI INELARE (12 FEȚE)/ IMBUSURI XZN 1/2"

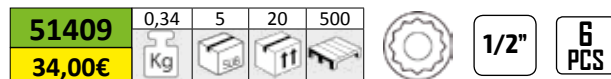

51409

34,00€

0,34	5	20	500
Kg	5	ff	ff



1/2"

6 PCS



M10, M12, M14, M16, M18, M20

TRUSĂ SPECIALĂ CU 55 CAPETE DE ȘURBELNIȚĂ HEAVY DUTY

52753	2,96	4	184
86,00€	Kg		

S-2 **55 PCS**

3/8"x10mm
1/2"x10mm
1/2"x14mm

H4, H5, H6, H7, H8, H10, H12, H14, H16
ISO 2136 (30 & 75mm)

M5, M6, M8, M10, M12, M14, M16
DIN 2325 (30 & 75mm)

T20, T25, T30, T40, T45, T50, T55, T60, T70, T80
(30 & 75mm)

▶ **PIESE DISPONIBILE
CONSULTAȚI CATALOGUL
DE PIESE**

HEAVY DUTY

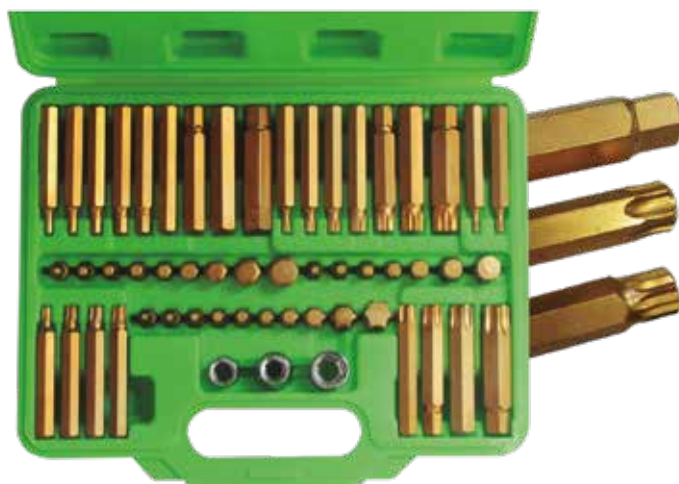

TRUSĂ SPECIALĂ CU 42 CAPETE ȘURBELNIȚĂ PT. ȘURUBURI TORX ȘI ȘURUBURI DE 12 ȘI 6 FEȚE

S-2

INVIOLABIL

S-2

50983	1,77	5	200
38,00€	Kg		

50985	1,74	5	240
49,00€	Kg		

42 PCS

50985 50983

CARACTERISTICI



4, 5, 6, 7, 8, 10, 12 (30mm)
4, 5, 6, 7, 8, 10, 12 (75mm)



T20, T25, T30, T40, T45, T50, T55, T60 (30mm)
T20, T25, T30, T40, T45, T50, T55, T60 (75mm)



M5, M6, M8, M10, M12 (30mm)
M5, M6, M8, M10, M12 (75mm)



3/8" 10mm
1/2" 10mm

▶ **PIESE DISPONIBILE
CONSULTAȚI CATALOGUL DE PIESE**



TRUSĂ CAPETE DE ȘURBELNIȚĂ 75 PIESE PENTRU ȘURUBURI RIBE, 12 FEȚE, TORX, TORX INV., HEXAGONAL

52550	3,61	4	72
74,50€	Kg		

S-2 **75 PCS**

4, 5, 6, 7, 8, 10, 12
(30 & 75mm)

T20H, T25H, T30H, T40H, T45H, T50H, T55H, T60H
(30 & 75mm)

M5, M6, M8, M10, M12(30 & 75mm)

M5, M6, M7, M8, M9, M10, M12, M14
(30 & 75mm)

T20, T25, T30, T40, T45, T50, T55, T60
(30 & 75mm)

3/8" 10mm /
1/2" 10mm (x2)

▶ **PIESE DISPONIBILE
CONSULTAȚI CATALOGUL DE PIESE**



TRUSĂ CAPETE TUBULARE PENTRU ȘURUBURI 12 FEȚE CU 26 PIESE

▶ **PIESE DISPONIBILE**
CONSULTAȚI CATALOGUL DE PIESE

52603	4,07	4	144		1/2"	26 PCS
72,00€						



55mm: M5, M6, M8, M9, M10, M12, M14, M16
100mm: M5, M6, M8, M9, M10, M12, M14
140mm: M5, M6, M8, M9, M10, M12, M14
200mm: M8, M10, M12, M14

52606	5,16	4	144		1/2"	32 PCS
76,00€						



55mm: M5, M6, M7, M8, M9, M10, M12, M13, M14
100mm: M5, M6, M7, M8, M9, M10, M12, M13, M14
140mm: M7, M8, M9, M10, M12, M13, M14
200mm: M7, M8, M9, M10, M12, M13, M14

TRUSĂ CAPETE TUBULARE HEXAGONALE PT. ȘURUBURI CU 30 PIESE

▶ **PIESE DISPONIBILE**
CONSULTAȚI CATALOGUL DE PIESE

52604	4,62	4	128		1/2"	30 PCS
66,00€						



55mm: H5, H6, H7, H8, H10, H12, H14, H17, H19
100mm: H5, H6, H7, H8, H10, H11, H12, H13
140mm: H5, H6, H7, H8, H10, H12, H14
200mm: H5, H6, H7, H8, H10, H12

52605	4,67	4	144		1/2"	32 PCS
72,00€						



55mm: T20, T25, T27, T30, T40, T45, T50, T55, T60, T70
100mm: T20, T25, T27, T30, T40, T45, T50, T55, T60, T70
140mm: T40, T45, T50, T55, T60, T70
200mm: T40, T45, T50, T55, T60, T70

UNELTE ÎN ȚOLI

TRUSĂ DE TUBULARE CU 35 PIESE ÎN ȚOLI

35
PCS



ZINCAT

51885	4,42	4	96
76,00€	Kg	ff	ff

CROMAT

53076	4,97	3	108
78,00€	Kg	ff	ff

1/2"

x17 5/16", 3/8", 7/16", 1/2", 9/16", 19/32", 5/8", 11/16", 3/4", 13/16", 7/8", 15/16", 1", 1-1/16", 1-1/8", 1-3/16", 1-1/4"

x1

x2 5", 10"

x1

x1

1/4"

x8 3/16", 7/32", 1/4", 9/32", 5/16", 11/32", 3/8", 7/16"

x1

x1

x1

x1 3"

x1

▶ **PIESE DISPONIBILE
CONSULTAȚI CATALOGUL
DE PIESE**

SET DE 17 CHEI COMBinate ÎN ȚOLI

17
PCS



ZINCAT

51890	3,92	4	192
89,00€	Kg	ff	ff

CROMAT

52972	4,60	4	
89,00€	Kg	ff	N



5/16", 3/8", 7/16", 1/2", 9/16", 19/32", 5/8", 11/16", 3/4", 13/16", 7/8", 15/16", 1", 1-1/16", 1-1/8", 1-3/16", 1-1/4"

SET DE 10 IMBUSURI HEXAGONALE ÎN ȚOLI

10
PCS



51970	0,28	10	60	1.500
9,90€	Kg	se	ff	ff

1/16", 5/64", 3/32", 1/8", 5/32", 3/16", 7/32", 1/4", 5/16", 3/8"



TRUSE DE SCULE DIN ALUMINIU

TRUSE DE SCULE DIN ALUMINIU 198PCS

N

53160	12,40	1	32	198 PCS	1/2"	1/4"
247,50€	Kg					

INCLUDE:



TRUSE DE SCULE DIN ALUMINIU 108PCS

N

53158	8,60	1	32	108 PCS	1/4"	3/8"
151,50€	Kg					

53444	8,60	1	32	108 PCS	1/2"	3/8"
168,60€	Kg					

INCLUDE:

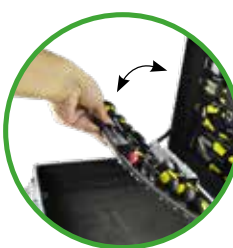

TRUSE DE SCULE DIN ALUMINIU

TRUSE DE SCULE DIN ALUMINIU 159PCS

N

53159	13,30	1	32
262,00€	Kg		

159 PCS	1/2"	1/4"
----------------	------	------

INCLUDE:



TRUSĂ DE 38 PIESE CU CLICHET TELESCOPIC DE 1/4"

53156	
21,00€	
Kg	0,48
	6
	36
	1.152



37 PCS



1/4"

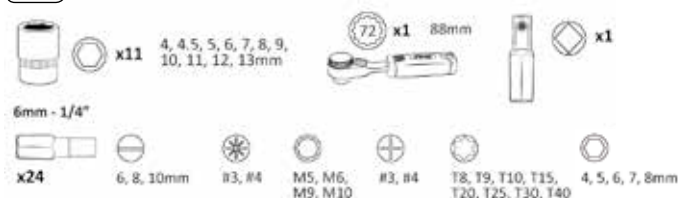

TRUSĂ DE 37 PIESE CU CLICHET TELESCOPIC DE 1/4"

52198	
29,00€	
Kg	0,45
	6
	36
	1.800



37 PCS



1/4"

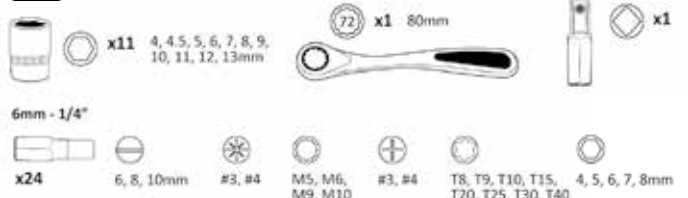

SET TUBULARE 1/2"

4, 4.5, 5, 5.5, 6, 7, 8, 9, 10, 11, 12, 13, 14mm

52714	0,65	4	24	576		1/2"
12,70€						



52716	0,60	4	24	576		1/2"	
13,50€							



▶ **PIESE DISPONIBILE**
CONSULTAȚI CATALOGUL DE PIESE

SET TUBULARE 1/4"

4, 4.5, 5, 5.5, 6, 7, 8, 9, 10, 11, 12, 13, 14mm

52715	0,27	6	36	1.152		1/4"
7,60€						



52717	0,27	6	36	1.152		1/4"	
8,20€							



▶ **PIESE DISPONIBILE**
CONSULTAȚI CATALOGUL DE PIESE

JOC CAPETE TUBULARE TORX 3/8" - 1/2"

53084	0,70	5	20		3/8"	1/2"	
19,00€							

3/8": T30, T40, T45, T50
1/2": T55, T60, T70



JOC 7 CAPETE TUBULARE TORX INVIOLABILE 1/4"

53127	0,10	100	1.000		1/4"	
7,50€						

T10, T15, T20, T25,
T30, T40, T45



PREZENTATE
ÎN GHIDUL METALICĂ

JOC CAPETE TUBULARE 1/4" (18 pcs)

52909	0,35	8	32	1.500	1/4"	S-2	18 PCS	
10,00€								



	T8, T10, T15, T20, T25, T27, T30		4, 5.5, 6.5mm
	#1, #2		#1, #2
			3, 4, 5, 6mm

JOC CAPETE TUBULARE 1/4" 30 UNITĂȚI

52908	0,60	8	32	500	1/4"	S-2	30 PCS	
14,30€								



	T8, T9, T10, T15, T20, T25, T27, T30		4, 5.5, 6.5, 7mm
	#0, #1, #2		3, 4, 5, 6mm
			#0, #1, #2

JOC CAPETE TUBULARE TS 5 FEȚE INVIOLABILE

51746	0,10	25	75	960
9,00€	Kg			

1/4"

7
PCS



TS10, 15, 20,
25, 30, 40, 45



JOC CAPETE TUBULARE TORX RIBE

50980	0,76	5	20	300
25,00€	Kg			



50982	0,46	10	40	300
19,00€	Kg			



52320	0,76	5	20	480
26,00€	Kg			



50980

1/2"

3/8"



1/2" 100mm:
M12, M13, M14
3/8" 90mm:
M6, M7, M8, M10

50982

3/8"



3/8" 100mm HB3:
4, 5, 6, 7, 8, 10mm

52320

1/2"

3/8"



1/2" 100mm:
M12, M13, M14
3/8" 90mm
M6, M7, M8, M10



TUBULARĂ CAPĂT XZN



1/2"



INVIOLABILĂ M16x58MM

12029	0,17	25	50	1.500
3,00€	Kg			



INVIOLABILĂ M16x100MM

12030	0,25	25	50	1.500
5,50€	Kg			



"T" DE FORȚĂ CU PĂTRAT EXTRALUNG 12 FEȚE - 800MM 1/2" 8mm Ø



52059	0,58	25	1.750
32,00€	Kg		

1/2"

Ø 8mm, 800mm

52060	0,58	25	1.750
32,00€	Kg		

1/2"

Ø 10mm, 800mm



TRUSĂ CAPETE TUBULARĂ ASORTATE

52539	1,90	5	128
56,00€	Kg		

85
PCS ALLEN 8

5x 8mm Hex. 7mm (ref. 10135)
5x 8mm Hex. 8mm (ref. 10136)
5x 8mm Hex. 10mm (ref. 10137)
5x 8mm Hex. 12mm (ref. 10138)
5x 8mm Hex. 14mm (ref. 10139)
5x 8mm Hex. 8mm (ref. 10144)
5x 8mm Plat (SL) 10mm (ref. 10140)
5x 8mm Plat (SL) 12mm (ref. 10141)
5x 8mm Stele (PH) #3 (ref. 10142)
5x 8mm Stele (PH) #4 (ref. 10143)

5x 8mm Dublu stele (PZ) #3 (ref. 10145)
5x 8mm Dublu stele (PZ) #4 (ref. 10146)
5x 8mm Torx (TX) T40 (ref. 10147)
5x 8mm Torx (TX) T45 (ref. 10148)
5x 8mm Torx (TX) T50 (ref. 10149)
5x 8mm Torx (TX) T55 (ref. 10150)
5x 8mm Torx (TX) T60 (ref. 10151)

➤ **PIESE DISPONIBILE
CONSULTAȚI CATALOGUL
DE PIESE**



TRUSĂ CAPETE ȘURUBELNIȚĂ ASORTATE

52538	2,07	16	128
56,00€	Kg		

1/4" **56**
PCS

5x Stele (PH) #1 (ref. 10117)
5x Stele (PH) #2 (ref. 10118)
5x Dublu Stele (PZ) #1 (ref. 10119)
5x Dublu Stele (PZ) #2 (ref. 10120)
5x Hex. 3mm (ref. 10121)
5x Hex. 4mm (ref. 10122)
5x Hex. 5mm (ref. 10123)
5x Hex. 6mm (ref. 10124)
5x Plat SL 4mm (ref. 10125)
5x Plat SL 5.5mm (ref. 10126)

5x Plat SL 6.5mm (ref. 10127)
5x Torx (TX) 8mm (ref. 10128)
5x Torx (TX) 10mm (ref. 10129)
5x Torx (TX) 15mm (ref. 10130)
5x Torx (TX) 20mm (ref. 10131)
5x Torx (TX) 25mm (ref. 10132)
5x Torx (TX) 27mm (ref. 10133)
5x Torx (TX) 30mm (ref. 10134)

➤ **PIESE DISPONIBILE
CONSULTAȚI CATALOGUL
DE PIESE**



SET DE 6 ADAPTOARE

51333	0,53	10	40	960
14,00€	Kg			

1/4"-3/8", 3/8"-1/2", 1/2"-3/4",
3/8"-1/4", 1/2"-3/8", 3/4"-1/2"



SET DE 3 ADAPTOARE MAGNETICE

51802	0,25	9	36	1.000
14,50€	Kg			

1/2" **1/4"** **3/8"**



ADAPTOARE

51877	0,02	200	2.000
2,80€	Kg		

50508	0,06	10	200	2.000
2,80€	Kg			

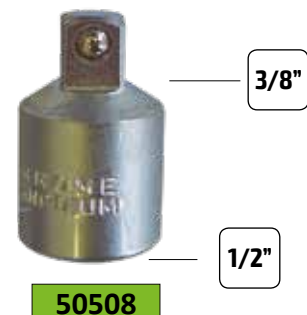

TRUSĂ DE PIESE IZOLATE CU 21 PIESE

N

53153	4,80	3	54
372,00€	Kg	11	11

21
PCS



1/2"

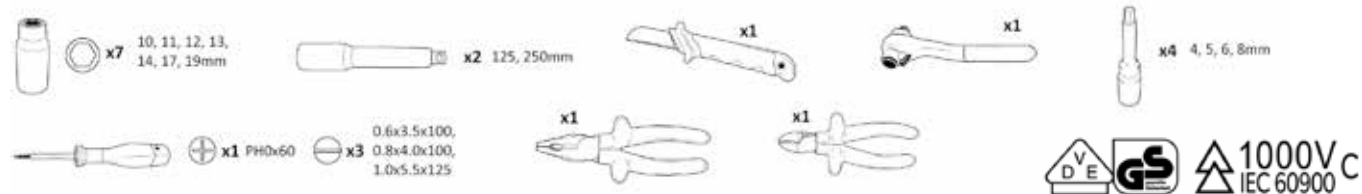

SET DE CHEI FIXE IZOLATE

N

53152	4,70	3	72
343,55€	Kg	11	11

1/2"



20
PCS

6-7-8-9-10-11-12-13-14-15-16-17-18-19-21-22-24-27-30-32mm



TRUSĂ DE PIESE IZOLATE
CU 20 PIESE DE 3/8"

N

53154	428,00€
-------	---------

Kg	3,3
11	3
11	72

20
PCS

3/8"

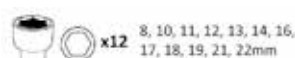

SET DE ȘURUBELNIȚE IZOLATE PENTRU ELECTRICIENI PÂNĂ LA 1.000V

52009	0,34	10	50
32,50€	Kg	3x6	1f

Optimizat pentru aplicații care lucrează cu energie electrică
Instrumentul de securitate

	0,4x2,5x100 0,8x4,0x100 0,6x3,5x100 1,2x6,5x100		PH1x100 PH2x100
--	--	--	--------------------

No: DIN EN60900:2005-01 - EN60900:2004



SET DE 50 ȘURUBELNIȚE IZOLATE

52521	1,43	6	240
109,00€	Kg	1f	3x6

	0,4x2,0x100, 0,4x2,5x100, 0,5x3,0x100, 0,6x3,5x100, 0,8x4,0x100, 1,0x5,5x100, 1,2x6,5x100
--	---

	PH0x100, PH1x100, PH2x100
--	---------------------------

	PZ0x100, PZ1x100, PZ2x100
--	---------------------------

	T6x100, T8x100, T9x100, T10x100, T15x100, T20x100, T25x100, T27x100, T30x100
--	--

	H2,5x100, H3,0x100, H4,0x100, H5x100, H6,0x100
--	---

	1x100, 2x100, 3x100, 4x100
--	----------------------------

	4x100, 6x100, 8x100, 10x100
--	-----------------------------

	M4x4,0x100, M5x5,0x100, M6x5,0x100
--	---------------------------------------

	4X100, 6x100, 8x100, 10x100
--	-----------------------------

	6,3x89, 8,1x89, Voltage Tester 3,0x70 + Torx 31x105
--	--

	R1x100, R2x100
--	----------------



AC 1000V
IEC 60900:2004

CUȚIT IZOLAT



DREPT

53164	
13,50€	
Kg	0,10
3x6	6
1f	36



CURBAT

53165	
16,00€	
Kg	0,10
3x6	6
1f	36



180mm 50mm



SET DE 7 ȘURUBELNIȚE IZOLATE 1.000V

52519	0,14	30	840
30,70€	Kg	1f	3x6

	1,5x0,23x50, 1,8x0,30x50, 2,0x0,40x50, 2,5x0,40x50, 3,0x0,50x50mm
--	--

	PH00x50 - PH0x50mm
--	--------------------

52520	0,67	12	288
38,00€	Kg	1f	3x6

	0,4x2,5x75, 0,8x4,0x100, 1,0x5,5x125, 1,2x6,5x150mm
--	--

	PH0x60, PH1x80, PH2x100mm Voltage Tester 3,0x70mm
--	--



AC 1000V
IEC 60900:2004



02

UNELTE MANUALE

CHEI COMBINATE CU RATCHET	33	CHEI ÎN CRUCE	46
SETURI DE CHEI	35	ȘURUBELNIȚE DE IMPACT	47
CHEI IMBUS	38	ȘURUBELNIȚE	48
CHEI ENGLEZE	38	TRUSE DE TAROZI ȘI FILIERE	49
CIOCAN	39	TAIETOR PENTRU TEAVĂ	50
LĂCĂȚI	40	CLEȘTI	51
DORNURI CILINDRICE	40	CHEI ȚEVI STILLSON	55
CLEȘTI	41	MENGHINĂ DE MÂNĂ	56
CLICHETURI	43	TĂIETOR DE JOJE	56
BARĂ "T" DE FORȚĂ	45		
BARE DE EXTINDERE	46		



SET DE 12 CHEI COMBinate CU CLICHET ȘI CAP ROTATIV

51318	2,15	5	10	240
99,00€	Kg	sub	ff	

8, 9, 10, 11, 12,
13, 14, 15, 16,
17, 18, 19mm



Cap articulată de la 0°
până la 180°
Clichet cu 72 dinți,
încăinare de 5°



➤ **PIESE DISPONIBILE**
CONSULTAȚI CATALOGUL DE PIESE

SET DE 7 CHEI COMBinate CU CLICHET ȘI CAP ROTATIV

53017	1,18	5	10	320
52,00€	Kg	sub	ff	



➤ **PIESE DISPONIBILE**
CONSULTAȚI CATALOGUL DE PIESE

SET 6 CHEI CU RATCHET

53021	0,86	5	20	1.500
48,00€	Kg	sub	ff	



➤ **PIESE DISPONIBILE**
CONSULTAȚI CATALOGUL DE PIESE



SET DE 7 CHEI CU RATCHET EXTRA LONG

53019	2,33	5	175
68,00€	Kg	ff	



➤ **PIESE DISPONIBILE**
CONSULTAȚI CATALOGUL DE PIESE



SET DE 8 CHEI COMBinate CU CLICHET SCURTE

53022	0,82	5	20	1.500
42,00€	Kg	sub	ff	

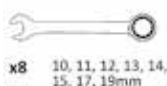

➤ **PIESE DISPONIBILE**
CONSULTAȚI CATALOGUL DE PIESE



SET DE 22 CHEI COMBinate CU RATCHET

53020	7,50	2	78
235,00€	Kg		



**22
PCS**



x22 6, 7, 8, 9, 10, 11, 12,
13, 14, 15, 16, 17, 18,
19, 20, 21, 22, 23, 24,
27,30, 32mm



➤ **PIESE DISPONIBILE
CONSULTAȚI CATALOGUL DE PIESE**

SET DE 4 CHEI TORX COMBinate CU CLICHER ARTICULAT

50754	0,82	20	360
59,00€	Kg		



**4
PCS**



x4 E6-E8, E10-E12,
E14-E18, E20-E24

Cap articulată de la 0°
până la 180°.
Clicher cu 72 dinți,
inclinare de 5°.



➤ **PIESE DISPONIBILE
CONSULTAȚI CATALOGUL DE PIESE**

SET DE 4 CHEI TORX CU CLICHER ARTICULAT

53023	0,83	5	20	1.000
59,00€	Kg			



**4
PCS**



x4 E6-E8, E10-E12,
E14-E18, E20-E24



➤ **PIESE DISPONIBILE
CONSULTAȚI CATALOGUL DE PIESE**

SET DE 10 CHEI HEXAGONALE COMBinate CU CLICHER ȘI CAP SEMIDESCHIS

51840	1,97	10	240
295,00€	Kg		







**10
PCS**

10, 11, 12, 13,
14, 15, 16, 17,
18, 19mm



TRUSĂ CHEI ARTICULATE CU TUBULARĂ INELARĂ CU 6 PIESE

51659	1,60	10	230	 Kg	 ff			6 PCS
56,00€								

8-9, 10-11, 12-13,
14-15, 16-17, 18-19mm



➤ **PIESE DISPONIBILE**
CONSULTAȚI CATALOGUL DE PIESE

SET DE 6 CHEI CU CLICHET ȘI CAP ROTATIV

53018	2,66	5	125	 Kg	 ff			6 PCS
128,00€								



SET DE 14 CHEI COMBinate

N

50560	1,25	5	20	240	ZINCAT
30,00€	 Kg	 SUB	 ff		

52970	1,30	2	16	384	CROMAT
33,00€	 Kg	 SUB	 ff		



**14
PCS**











6, 7, 8, 9, 10, 11, 12,
13, 14, 15, 16, 17, 18,
19mm



SET DE 7 CHEI COMBinate

N

ZINCAT				
50896	3,00	2	8	200
45,00€	 Kg	 SUB	 ff	

CROMAT				
52971	2,55	2	8	224
47,00€	 Kg	 SUB	 ff	

7 PCS			20, 21, 22, 23, 27, 30, 32mm
------------------	---	---	---------------------------------



SET DE 12 CHEI FIXE

N

51529	52973
44,00€	46,00€
2,63	2,50
5	2
165	8
ZINCAT	CROMAT

12 PCS

6x7, 8x9, 10x11, 12x13, 14x15, 16x17, 18x19, 20x22, 21x23, 24x27, 25x28, 30x32mm



SET DE 7 CHEI FIXE

N

50561	52974
11,90€	15,30€
0,69	0,70
5	2
20	20
320	440
ZINCAT	CROMAT

7 PCS

6x7, 8x9, 10x11, 12x13, 14x15, 16x17, 18x19mm



SET DE 12 CHEI INELARE CU COT 12 FEȚE

N

50889	3,66	5	280
59,00€			

ZINCAT

52975	3,55	1	4	200
62,00€				

CROMAT



12 PCS

6x7, 8x9, 10x11, 12x13, 14x15, 16x17, 18x19, 20x22, 21x23, 24x27, 25x28, 30x32mm

SET DE 7 CHEI INELARE CU COT

N

50562	52976
16,50€	19,70€
0,87	1,20
5	2
20	12
500	288
ZINCAT	CROMAT

ZINCAT

CROMAT

7 PCS

6x7, 8x9, 10x11, 12x13, 14x15, 16x17, 18x19mm



SET DE 7 CHEI COMBinate CURBATE

50563	0,93	5	10	560
22,00€				



10, 11, 13, 14, 15, 17, 19mm

SET DE 8 CHEI INELARE SEMILUNĂ

52451	0,93	20	300
30,50€			

PCS

6x7, 8x9, 10x11, 12x13, 14x15, 16x17, 18x19, 20x22mm



SET DE 8 CHEI COMBinate SCURTE

50564	0,65	5	20	400
18,00€				

PCS

10, 11, 12, 13, 14, 15, 17, 19mm



SET DE 6 CHEI INELARE EXTRALUNGI 12 FEȚE

51864	1,87	10	250
64,00€	Kg	ff	ff



10x11mm (290mmL),
12x14mm (330mmL),
13x15mm (368mmL),
16x18mm (407mmL),
17x19mm (407mmL),
22x24mm (430mmL)

SET DE 6 CHEI INELARE EXTRALUNGI TORX

52912	1,62	10	220
77,50€	Kg	ff	ff



E6xE7 (200mmL),
E8xE10 (235mmL),
E11xE12 (290mmL),
E14xE16(370mmL),
E18xE20 (410mmL),
E22xE24 (420mmL)

SET DE CHEI INELARE 12 FEȚE

51878	1,00	5	10	240
41,10€	Kg	ff	ff	ff



6x7, 8x9, 10x11, 12x13, 14x15,
16x17, 18x19, 20x22mm

SET CHEI INELARE 6 FEȚE

51879	0,74	5	20	480
31,40€	Kg	ff	ff	ff



10x11 Hex, 12x13 Hex, 14x15
Hex, 16x17 Hex, 18x19 Hex

SET DE 8 TUBULARE



53420	1,50	20	540
56,65€	Kg	ff	ff

**8
PCS**

6x7, 8x9, 10x11, 12x13,
14x15, 16x17, 18x19, 20x22mm



JOÇ DE 4 CHEI TORX LATE ÎN SUPTOR DE PÂNZĂ

51747	0,38	50	500
21,00€	Kg	ff	ff



6x8
10x12
14x18
20x24mm



SET DE 14 CHEI TUBULARE CU COT TIP "L"

51528	3,55	5	280
29,00€	Kg	ff	ff

**14
PCS**

8, 9, 10, 11, 12, 13, 14, 15, 16,
17, 18, 19, 20, 21mm



SET DE 9 CHEI TORX "L" 275mm

52074	0,35	5	20	1.344
15,00€	Kg	sub	ff	



275mm



T10, T15, T20, T25, T27, T30, T40, T50mm



SET DE 11 CHEI IMBUS "L" DE 275mm

52073	0,81	6	24	1.008
15,00€	Kg	sub	ff	



275mm



1,5, 2, 2,5, 3, 4, 5, 5,5, 6, 8, 10, 12mm



SET DE 10 CHEI IMBUS

50571	0,29	10	50	3.250
5,80€	Kg	sub	ff	



1,5, 2, 2,5, 3, 4, 5, 5,5, 6, 8, 10mm



SET DE 9 ȘURUBELNIȚE TORX ÎN "T"

51959	1,49	5	10	110
26,10€	Kg	sub	ff	



T10x100mm
T15x100mm
T20x100mm
T25x150mm
T27x150mm
T30x150mm
T40x150mm
T45x200mm
T50x200mm



SET DE 9 CHEI IMBUS ÎN "T"

52684	1,54	10	10	110
26,60€	Kg	sub	ff	



2, 2,5, 3, 4, 5, 6, 7, 8, 10mm



SET DE 8 CHEI ÎN "T" CU CAP SEMIROTUND

51954	1,00	10	100	
24,40€	Kg	ff		



1, 2, 3, 4, 5, 6, 8, 10mm



CHEIE ENGLEZĂ

MOD. 1

51798	1,96	1	5	295
25,40€	Kg	sub	ff	

18"



53mm

52424	3,64	1	5	175
54,80€	Kg	sub	ff	

24"



62mm



MOD. 2

51794	0,16	6	48	7.680
4,50€	Kg	sub	ff	

6"



18mm

51795	0,28	6	120	3.600
6,80€	Kg	sub	ff	

8"



22mm

51796	0,48	6	36	2.400
8,90€	Kg	sub	ff	

10"



28mm

51797	0,71	6	24	960
12,00€	Kg	sub	ff	

12"



37mm



CIOCANE PROFESIONALE CU MÂNER DIN FIBRĂ

52182	2,26	6	12	480	2Kg	↔297mm↔
18,60€	Kg					
52184	4,31	4	128		4Kg	↔880mm↔
39,50€	Kg					
52185	6,97	4	72		6Kg	↔895mm↔
55,40€	Kg					
52186	8,68	2	60		8Kg	↔900mm↔
68,00€	Kg					



CIOCAN

LĂCĂTUȘ CU MÂNER DIN LEMN

51674	0,50	6	36	864	505g
5,80€	Kg				
52565	1,13	6	24	600	1Kg
8,80€	Kg				



CAP DREPT ȘI SEMIROTUND

51918	1,34	6	18	432	1Kg
9,50€	Kg				
51504	0,55	4	40	1.280	454g
5,30€	Kg				

CIOCAN PROFESIONAL FĂRĂ RECUL

52180	1,33	6	12	360	1,35Kg	↔355mm↔
16,10€	Kg					
52181	1,81	6	12	300	1,80Kg	↔370m↔
18,20€	Kg					
52183	2,21	6	12	240	2,20Kg	↔405m↔
26,20€	Kg					



CIOCAN DIN PLASTIC FĂRĂ RECUL

52425	0,70	6	12	500	∅ 40mm
23,90€	Kg				
52426	1,68	2	12	204	∅ 60mm
43,50€	Kg				
52427	2,02	2	12	204	∅ 70mm
54,10€	Kg				



FETE DE SCHIMB PENTRU CIOCANUL DIN PLASTIC

REF.	∅	Kg		€
11212	∅ 40mm	0,02	5	4,30€
11213	∅ 60mm	0,08	5	9,20€
11214	∅ 70mm	0,11	6	11,00€



TOPOARE CU MÂNER DIN LEMN

52188	0,82	4	24	875	
10,80€	Kg				

52460	1,17	4	24	864	
11,70€	Kg				

52461	1,82	4	12	432	
18,70€	Kg				



BOMFAIER

51675	0,26	10	48	720	
6,00€	Kg				

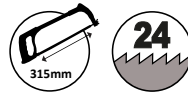
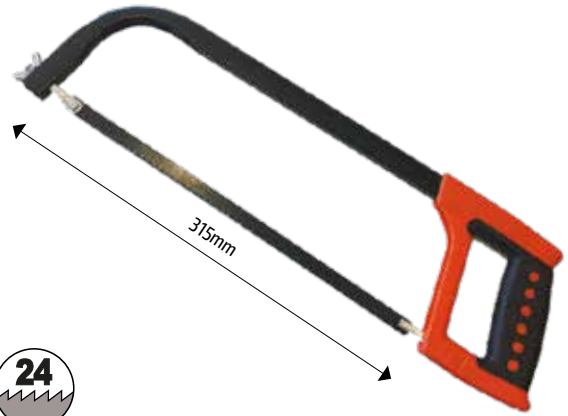

FERĂSTRĂU ARC CU MÂNER ERGONOMIC

52830
20,30€

Kg	0,63
	10
	20
	780

300mm
12"



În interpret
10 unități



FERĂSTRĂU ARC

52831
13,80€

Kg	0,49
	10
	20
	940

300mm
12"

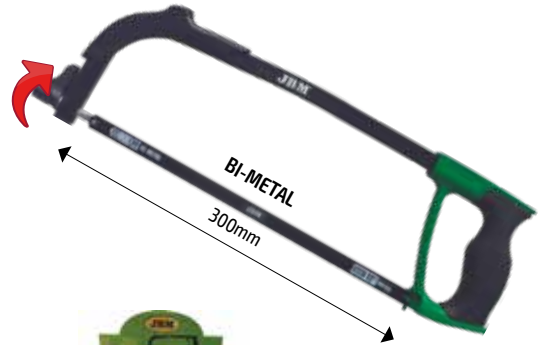

În interpret
10 unități



LAME PT. FERĂSTRĂU ARC REF.52830 și 52831

12060	0,02	10	100
1,60€	Kg		

SET DE 5 DORNURI CONICE

52049
9,60€

Kg	0,43
	10
	40
	3.840

3, 4, 5, 6, 7mm



SET DE 5 DORNURI CILINDRICE

52013
9,50€

Kg	0,38
	10
	40
	3.840

4, 5, 6, 7, 8mm



SET DE 6 DORNURI CILINDRICE

53095
14,00€

Kg	0,76
	6
	24

∅ 3, 4, 5, 6, 7, 8mm
Largo:150mm



DĂLȚI

53120	0,56	6	24	
3,90€	Kg	sub	ff	150mm

53121	0,55	6	24	720
4,80€	Kg	sub	ff	250mm

53122	0,90	6	12	432
6,00€	Kg	sub	ff	350mm



SET DE 4 DĂLȚI

53083	1,09	10	20	
44,00€	Kg	sub	ff	

18x125mm, 21x150mm,
26x200mm, 29x250mm



SET DE 5 DĂLȚI

52014	0,47	10	40	3.840
12,00€	Kg	sub	ff	

10, 11, 12, 14, 16mm



JOC DE 3 SPATULE

51951	0,42	15	360	
15,60€	Kg	ff	ff	

Mâner ergonomic de 40, 60, 80mm



SET DE 4 SPATULE DE OȚEL

53339	0,25	10	40	470
7,45€	Kg	sub	ff	

4 PCS
2", 3", 4", 6"



SET DE 5 PILE

51853	0,89	20	480	
13,90€	Kg	ff	ff	

310mm



CLEȘTE PENTRU NITURI EXTENSIBILI 10"

53331	0,80	5	20	280
25,80€	Kg	sub	ff	

10"

250mm

2,4mm (3/32)
3,2mm (1/8)
4,0mm (5/32)
4,8mm (3/16)
6,4mm (1/4)



CLEȘTE BĂTUT NITURI 8"

53332	1,65	5	10	280
27,95€	Kg	sub	ff	

8"

200mm

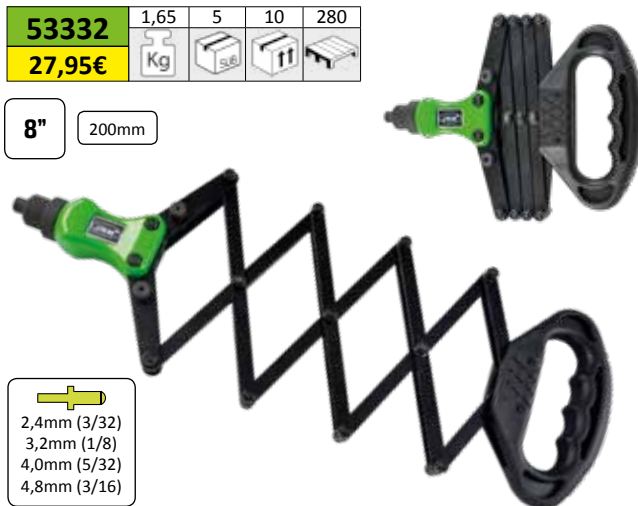

2,4mm (3/32)
3,2mm (1/8)
4,0mm (5/32)
4,8mm (3/16)

CLEȘTE POPNITURI PROFESIONAL 200MM / 8"

52595
49,60€

Kg	1,30
ft	10
ft	140

M3, M4,
M5, M6



CLEȘTE DE NITUIT PROFESIONAL 200MM/8"

52462
21,30€

Kg	0,56
ft	6
ft	30
ft	900

2,4mm (3/32)
3,2mm (1/8)
4,0mm (5/32)
4,8mm (3/16)



CLEȘTE BĂTUT NITURI 300MM / 12"

52463
19,90€

Kg	0,74
ft	20
ft	300

3,2mm (1/8)
4,0mm (5/32)
4,8mm (3/16)



CLEȘTE BĂTUT NITURI 400MM/16"

52464
36,50€

Kg	0,68
ft	10
ft	220

2,4mm (3/32)
3,2mm (1/8)
4,0mm (5/32)
4,8mm (3/16)
6,4mm(1/4)



CLEȘTE POPNITURI 400MM / 16"

52596
95,00€

Kg	3,07
ft	5
ft	75

M3, M4, M5, M6,
M8, M10, M12



CLEȘTE POPNITURI AUTOMĂTIC 440MM / 17"

52597
114,50€

Kg	3,25
ft	5
ft	70

M3, M4, M5, M6,
M8, M10, M12



SET DISPOZITIV DE NITUIT + NITURI DE PLASTIC

52609
27,70€

0,50	10	20	240
Kg	ft	ft	ft

10 u. Ø 6,6mm x 17,2mm
10 u. Ø 6,3mm x 25,2mm
10 u. Ø 5mm x 17,2mm
10 u. Ø 5mm x 15,8mm

NITURI DE PLASTIC

REF.	DESCRIERE	Kg	ft	€
13674	NITURI DE PLASTIC 6 X 19,3MM	0,01	25	0,30€
13675	NITURI DE PLASTIC 6 X 17,8MM	0,01	25	0,30€
13676	NITURI DE PLASTIC 6 X 25,5MM	0,01	25	0,35€
13677	NITURI DE PLASTIC 6 X 24,5MM	0,01	10	0,30€
13678	NITURI DE PLASTIC 6 X 24MM	0,01	10	0,30€



PISTOL NITUIT PNEUMATIC

52575
85,30€

1,71	10	150
Kg	ft	ft

2,4mm (3/32), 3,2mm (1/8)
4,0mm (5/32), 4,8mm (3/16)

Putere de tracțiune: 1586LBS / 720 KGS
Lungime tijă: 9/16" - 14MM
Max. strângere: 60FT-20-IB / 23-69MM
Admisie aer: 1/4"
Mâner 3/8"
Consum aer: 0.03CFM/0.86L/MIN
Debit recomandat în compresor 1,5 HP

INCLUDE:
- 2 Multiunelte
- Lipit rapid
- Oringuri



NITURI DISPONIBILE ÎN PAG. 243

CLICHET CU 72 DINȚI 1/2" CU SET TUBULĂRE



52948	1,24	4	24	384
25,00€	Kg	sub	ff	

1/2" 10, 11, 12, 13, 14, 15, 16, 17, 18, 19mm

52950	0,35	6	36	864
14,50€	Kg	sub	ff	

1/4" 4, 5, 6, 7, 8, 9, 10, 11, 12, 13mm



52949	1,22	4	24	384
25,00€	Kg	sub	ff	

1/2" 10, 11, 12, 13, 14, 15, 16, 17, 18, 19mm

52951	0,34	6	36	864
14,50€	Kg	sub	ff	

1/4" 4, 5, 6, 7, 8, 9, 10, 11, 12, 13mm



CROM CLICHET

53098	0,15	12	36
13,00€	Kg	sub	ff

1/4" 145mm

53099	0,29	12	24
15,00€	Kg	sub	ff

3/8" 200mm

53100	0,59	12	24
18,00€	Kg	sub	ff

1/2" 255mm



în interpret
12 unități



CLICHET CU 24 DINȚI CONȚINE 12 UNITĂȚI

51285	0,14	12	36	1.080
11,00€	Kg	sub	ff	

1/4" 155mm

51286	0,35	12	36	600
11,00€	Kg	sub	ff	

3/8" 210mm

51287	0,57	12	24	960
13,00€	Kg	sub	ff	

1/2" 260mm



în interpret
12 unități



CLICHET CU 72 DINȚI CONȚINE 12 UNITĂȚI

51382	0,14	12	36	1.008
12,00€	Kg			

1/4" 145mm

51270	0,28	12	24	-
14,00€	Kg			

3/8" 200mm

51921	0,58	12	24	960
18,00€	Kg			

1/2" 200mm

52207	0,05	12	240	8.400
15,00€	Kg			

1/4" 85mm



În interpret
12 unități



În interpret
12 unități

CLICHET ARTICULAT CU 72 DINȚI

52587	0,16	12	144	3.456
27,00€	Kg			

1/4" 175mm

52588	0,17	12	144	3.456
27,50€	Kg			

3/8" 175mm

51305	0,31	12	48	816
16,00€	Kg			

1/2" 175mm

51306	0,30	12	48	816
14,00€	Kg			

1/4" 175mm



În interpret
12 unități



În interpret
12 unități



CLICHET 72 DINȚI CU CAP ROTATIV

51405	0,15	12	48	1.440
20,30€	Kg			

1/4" 145mm

51406	0,66	12	24	960
29,20€	Kg			

1/2" 280mm



În interpret
12 unități



CLICHET 48 DINȚI CU CAP ROTATIV

52585	0,15	12	72	2.160
29,30€	Kg			

1/4" 185mm

52586	0,73	12	24	768
36,00€	Kg			

1/2" 310mm



În interpret
12 unități



CLICHET FLEXIBIL 72 DINȚI DE 3/8"

51801	0,57	40	160	500mm
57,00€	Kg			3/8"

Foarte util pentru locuri de acces dificil.



CU CAP GIRATORIU.

CLICHET EXTENSIBIL DE 1/4" 72 DINȚI



53346	0,25	6	12	1/2"	16,5 - 21,5cm
16,00€	Kg				



EXTENSIBIL

CLICHET ARTICULAT EXTENSIBIL DE 1/2" 72 DINȚI

52197	1,04	6	12	480
41,50€	Kg			

350-490mm
1/2"



ROTAȚIE DE 180°

EXTENSIBIL

În interpret 6 unități

CLICHET EXTENSIBIL DE 1/2" 72 DINȚI

51307	0,92	6	12	648
29,70€	Kg			

30,5-44cm
1/2"



În interpret 6 unități

Din oțel forjat cu tratament termic

MÂNER ERGONOMIC EXTENSIBIL

BARĂ "T" DE FORȚĂ

52524	3,65	3	6	192
43,60€	Kg			

3/4"

1.020mm



52526	1,83	5	10	500
22,80€	Kg			

1/2"

600mm

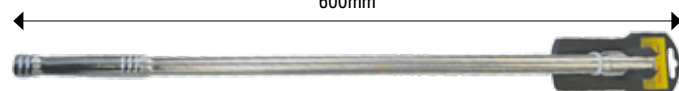

52525	0,78	10	20	1.920
11,10€	Kg			

1/2"

430mm

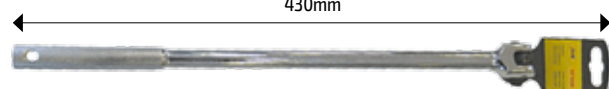

3/4"

11947



1/2"

11945



1/2"

11946

REF.	"	PENTRU	Kg			€
11947	3/4"	52524	0,51	10	40	5,50€
11945	1/2"	52526	0,2	20	100	5,30€
11946	1/2"	52525	0,06	-	300	2,90€

SET DE PRELUNGITOARE 1/2" CU CAP SEMIROTUND

51448	2,38	5	250	1/2"	
48,20€	Kg				

50, 125, 250, 380, 510MM



SET DE PRELUNGITOARE 1/4" CU CAP SEMIROTUND ȘI CAP NORMAL

51447	0,34	20	1.000	1/2"	
12,00€	Kg				

50, 75, 100, 152, 227MM

51805	0,34	20	1.000	1/4"	
15,00€	Kg				

50, 75, 100, 152, 227MM



PRELUNGITOR EXTENSIBIL DE 1/2" CU CAP SEMIROTUND

51479	0,65	24	1.056	260-410mm	1/2"
25,50€	Kg				



În interpret
12 unități



RECUPERATOR FLEXIBIL VÂRF CU 4 GHEARE

51526	0,09	12	144	1.728
6,80€	Kg			

500mm 20mm

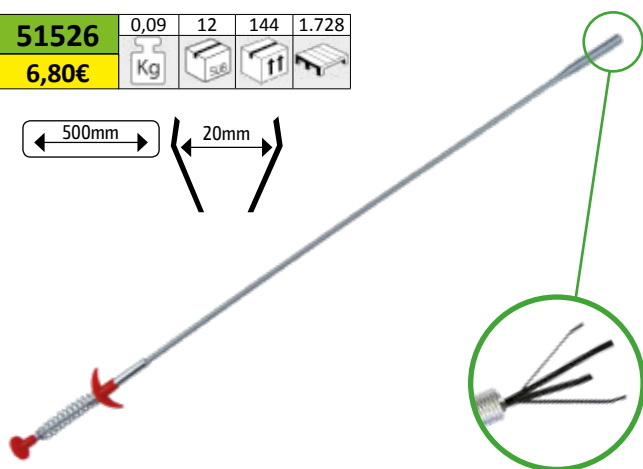

RECUPERATOR FLEXIBIL CU MAGNET ȘI LED

52473	0,09	12	144	1.728	
6,30€	Kg				

545mm



RECUPERATOR EXTENSIBIL CU MAGNET

52472	0,04	12	108	4.320	
3,60€	Kg				

2,5 Kg
135-600mm



RECUPERATOR FLEXIBIL CU MAGNET

51525	0,14	10	60	1.440	
6,80€	Kg				

0,5 Kg
7mm
500mm

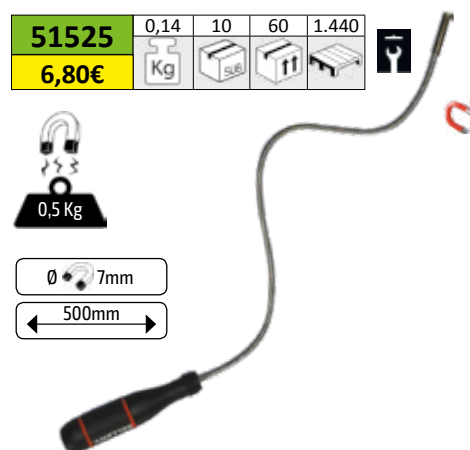

CHEIE ÎN CRUCE LEGĂTURA SUDATĂ

51661	1,17	20	480	1/2"
8,90€	Kg			

17, 19, 21mm
355mm

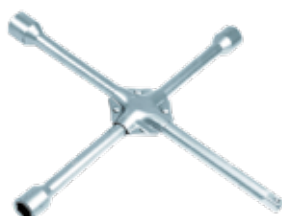

52881	1,40	10	420	1/2"
11,90€	Kg			

17, 19, 21, 22mm
400mm
1/2"

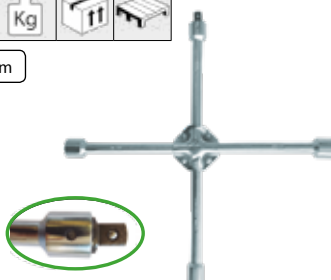

52880	3,75	5	100	3/4"
24,90€	Kg			

24, 27, 32mm
700mm

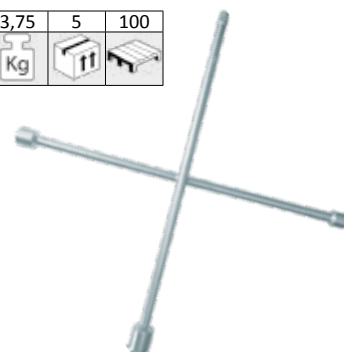

DISPOZITIV TELESCOPIC CU MAGNET ȘI LED

51272	0,08	12	144	1.728
6,80€	Kg			



90-810mm



în interpret
12 unități

OGLINDĂ DE INSPECȚIE TELESCOPICĂ ARTICULATĂ

52468	0,09	12	48	2.400
4,80€	Kg			

280-445 mm
∅ 50mm



SET DE 3 ȘURUBELNIȚE

51952	0,45	4	48	1.056
9,90€	Kg			

51953	0,44	4	48	864
9,90€	Kg			

	6X100mm 6X150mm 6X200mm	
--	-------------------------------	--

	6X100mm 6X150mm 6X200mm	
--	-------------------------------	--



ȘURUBELNIȚĂ REVERSIBILĂ LATĂ - INELARĂ

51955	0,11	24	96	1.344
3,60€	Kg			

52068	0,11	24	96	960
3,50€	Kg			

6x150mm

6x100mm



în interpret
24 unități

MAGNETIZATOR / DEMAGNETIZATOR



53225	0,10	12	96	2.016
2,80€	Kg			



ȘURUBELNIȚĂ DE IMPACT

52325	0,85	6	24	768
12,00€	Kg			

3/8"

Pătrat de 3/8"
Adaptor de 5/16"

	N.2, N.3		5/16" 9/32"
--	----------	--	----------------



ȘURUBELNIȚĂ 6 ÎN 1

52072	0,19	12	72	1.728
5,00€	Kg			



- 1 Bit PH1
 - 1 Bit PH2
 - 1 Bit lat 5mm
 - 1 Bit lat 6mm
 - 1 Tubulară Hex n.8
 - 1 Tubulară Hex n.9 r-V
- Fabricată din oțel Cr-V



JOC DE ȘURUBELNIȚE DE IMPACT MAGNETICE

52748	2,05	8	112
34,50€	Kg	Sub	ff



6x38	3.2x75
5x75	6x100
8x150	9.5x200 mm

PH2x38	PH0x75
PH1x75	PH2x100
PH3x150	PH4x200 mm



MÂNER DIN
CAUCIUC

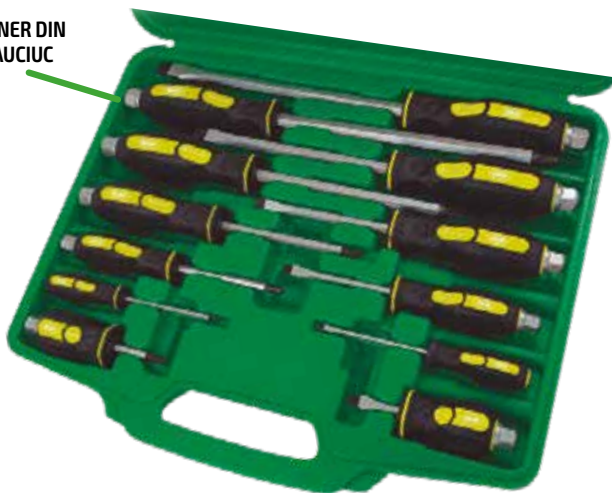

JOC DE 4 ȘURUBELNIȚE LATE DE IMPACT

50902	0,65	6	24	720
9,00€	Kg	Sub	ff	ff

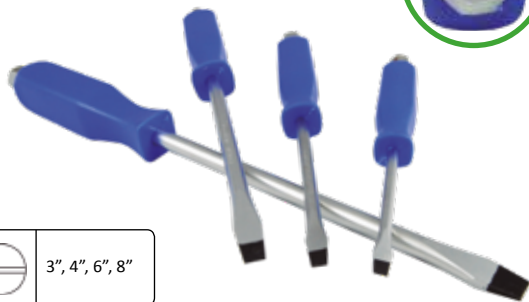

3"	4"	6"	8"
----	----	----	----

ȘURUBELNIȚĂ FLEXIBILĂ

52170	0,27	48	12	672
14,00€	Kg	Sub	ff	ff



1/4"



4, 5, 6, 7, 8, 10mm



TRUSĂ DE ȘURUBELNIȚE CU MÂNERE ÎNTERSCHIMBĂBILE

53010	0,72	5	20	480
14,90€	Kg	Sub	ff	ff



PCS

MÂNER CU
PRIZĂ MOALE



4x6mm	5x7mm
-------	-------

H4x4mm, capeta de bola	H5x5mm, capeta de bola	H6x6mm, capeta de bola
------------------------	------------------------	------------------------

T10x15	T20x25	T30x40
--------	--------	--------

#1	#2
----	----

SET DE 8 ȘURUBELNIȚE

52500	0,33	60	720
14,80€	Kg	Sub	ff

SCURTE

0.4x2x25, 0.4x2.5x25, 0.5x3x.25,
0.5x3.5x25, 0.8x4x25

PH00x25, PH0x25, PH1x25



52501	0,50	30	480
18,00€	Kg	Sub	ff

LUNGI

0.4x2x75, 0.4x2.5x75, 0.5x3x.75,
0.5x3.5x75, 0.8x4x75

PH00x75, PH0x75, PH1x75



JOC DE 3 ȘURUBELNIȚE FLEXIBILE

52169	0,44	48	12	672
19,00€	Kg	Sub	ff	ff



6, 7, 8mm



SET DE 7 ȘURUBELNIȚE CU EVA MODUL

51378	0,81	10	30	240
16,30€	Kg	3x6	11	

	PH4x200 PH3x150 PH2x100 PH2x38	PH1x80 PH0x120 PH1x100
--	---	------------------------------

51380	0,8	10	30	240
16,30€	Kg	3x6	11	

	9x200mm 4x125mm 5x100mm 5x80mm	6x38mm 6x100mm 8x150mm
--	---	------------------------------

51381	0,55	10	30	450
12,00€	Kg	3x6	11	

	T8x75 T9x75 T10x75 T15x75	T20x75 T25x100 T27x100
--	------------------------------------	------------------------------

180mm	380mm	30mm
-------	-------	------



TRUSĂ DE TAROZI ȘI FILIERE ÎN MM ȘI ȚOLI CU 60 PIESE

50793	2,35	5	185
64,00€	Kg	11	

**60
PCS**



- 1 Tarod NPT (toli): 1/8-27 1 filieră NPT (toli): 1/8-27
- 1 Suport de Tarozii mixt: M3 ~ M12 și 3/16 ~ 1/2"
- 1 Suport de Tarozii mixt tip T: M3 ~ M6 6-32 și 4-40
- 1 Suport Filiere mixt : 25mm de diametru/ 1 Șurubelniță,
- 1 Set de lere pentru măsurat filet în mm,
- 1 Set de lere pentru măsurat filet în țoli,
- 10 Seturi de tarozii (mm): M3x0,5, M4x0,7, M5x0,8, M6x1,0, M7x1,0, M8x1,25, M9x1,25, M10x1,0, M10x1,5, M12x1,75
- 10 Filiere UNC (țoli): 4-40, 6-32, 8-32, 10-24, 12-24, 1/4-20, 5/16-18, 3/8-16, 7/16-14, 1/2-13
- 6 Filiere UNF (țoli): 10-32, 1/4-28, 5/16-24, 3/8-24, 7/16-20, 1/2-20
- 10 Filiere (mm): M3x0,5, M4x0,7, M5x0,8, M6x1,0, M7x1,0, M8x1,25, M9x1,25, M10x1,0, M10x1,5, M12x1,75
- 10 Filiere UNC (țoli): 4-40, 6-32, 8-32, 10-24, 12-24, 1/4-20, 5/16-18, 3/8-16, 7/16-14, 1/2-13
- 6 Filiere UNF (țoli): 10-32, 1/4-28, 5/16-24, 3/8-24, 7/16-20, 1/2-20

TRUSĂ DE TAROZI ȘI FILIERE CU 58 PIESE ACOPERITE CU UN STRAT DE TITAN

50792	2,59	6	240
108,00€	Kg	11	

**60
PCS**



- 1 Tarod tip NPT : 1/8-27
- 1 Filieră tip NPT : 1/8-27
- 1 Suport tarozii : M4~M12
- 1 Suport tarozii tip T : M3~M6
- 1 Suport Filiere : 25 mm O/D
- 1 Șurubelniță
- 1 Set de lere pentru măsurarea filetelor
- 17 Tarozii : 2x0,4, 3x0,6, 3x0,5, 3,5x0,6, 4x0,75, 4x0,7, 5x0,8, 6x0,75, 6x1,0, 7x0,75, 7x1, 8x1,0, 8x1,25, 10x1,25, 10x1,5, 12x1,25, 12x1,75
- 17 Filiere : 2x0,4, 3x0,6, 3x0,5, 3,5x0,6, 4x0,75, 4x0,7, 5x0,8, 6x0,75, 6x1,0, 7x0,75, 7x1, 8x1,0, 8x1,25, 10x1,25, 10x1,5, 12x1,25, 12x1,75

CUTTER PROFESIONAL

51909	0,07	24	192	3.456
2,50€	Kg	11	11	

10cm



în interpret
24 unități



MĂNER
ANTI-ALUNECARE.

FOARTE
REZISTENT.

SET CUTTER + LAMĂ CUȚIT DE SCHIMB

51611	0,62	32	280
9,00€	Kg	11	



FOARFECĂ PROFESIONALĂ ASIMETRICĂ

51887	0,04	24	144	2.016
2,50€	Kg	11	11	

200mm

Foarfecă din oțel



în interpret
24 unități

REZISTENȚĂ
ȘI UȘOARĂ

CUȚIT CU SISTEM PENTRU SPART GEAMURI ȘI TĂIAT CENTURI DE SIGURANȚĂ

52786	0,16	12	60	2.040	
11,30€					



În interpret
12 unități



APARAT DE ÎNDOIT TUBURI 6-8-10mm

52905	0,51	6	24		
27,90€					

6, 8, 10mm

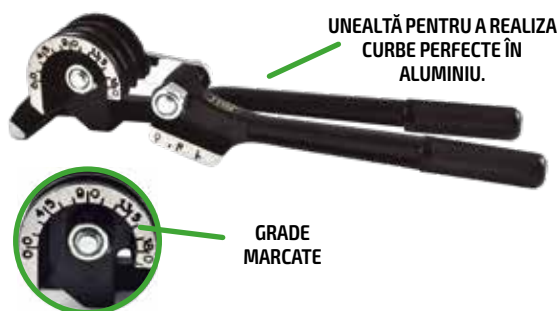

TAIETOR PENTRU TEAVĂ

52878	0,22	10	50	1.500	
11,20€					

3-32mm

52879	0,24	10	50	1.500	
11,20€					

3-35mm



52878

52879

REF.	DESCRIERE	PENTRU		€
12964	Roti din oțel	52878	0,01	1,50€
12965	Roti din oțel	52879	0,01	1,80€

FOARFECE PENTRU TĂIEREA TUBURILOR

52877	0,43	48	720		
13,00€					

1-5/8" 42mm



CLEȘTE PENTRU DEZIZOLAT CABLURI AUTOAJUSTABIL

51972	0,25	10	100	800	
10,80€					

0,08-6mm

Pentru dezizolare cabluri din plastic sau cauciuc, individual sau multiplu, cu secțiuni de la 0.08 până la 6 mm². Ajustare automată a corodării vrac pentru diferite secțiuni.

Pentru cabluri de cupru și aluminiu, posibilitate de a dezizola mai multe cabluri odată cu secțiunea de 6 mm² cel mult.

Posibilitate de a dezizola cablu individual începând de la 0.08 mm² de secțiune. Nu provoacă deteriorarea firului conductor; durabilitate mare.



FOARFECĂ DE TĂIAT CABLU ELECTROIZOLANT

52152	0,08	12	120	1.440	
10,10€					

140mm



CLEȘTI MINI PT DEZMEMBRAREA CABLULUI

53411	0,05	12	120		
3,25€					

127mm



53412	0,05	12	120		
2,65€					

94mm



CLEȘTE PLEGABIL MULTIFUNȚIONAL + CAPETE ȘURUBELNIȚĂ

52411	0,37	12	48	2.880
16,00€	Kg	3x5	1x11	1x15

180mm

1 x șurubelniță stelată
1 x deschizător sticle +
deschizător conserve
3 x șurubelnițe late
1 x ferăstrău
1 x cuțit mic 35 mm
1 x cuțit mare 65 mm
1 x adaptor biți 1/4"
9 x capete șurubelniță:
1 x HEX 3mm, 1 X HEX 4mm,
1 x HEX 5mm, 1 x LATĂ 4mm,
1 x LATĂ 5mm, 1 X LATĂ 6mm,
1 x PH1, 1 X PH2, 1 X PH3



CLEȘTE MINI PLEGABIL MULTIFUNȚIONAL

52412	0,09	24	144	5.760
5,00€	Kg	3x5	1x11	1x15

105mm

2 x șurubelnițe late
1 x pilă 25mm
1 x deschizător sticle
1 x deschizător conserve
1 x cuțit 40mm
1 x șurubelniță stelată
1 x ferăstrău 40mm



CLEȘTE DE SERTIZAT PENTRU TERMINALE

PENTRU TERMINALE IZOLATE ȘI NEIZOLATE

52761	0,25	12	72	1.296
7,00€	Kg	3x5	1x11	1x15



9"



PENTRU TERMINALE NEIZOLATE

52762	0,25	12	72	1.296
7,60€	Kg	3x5	1x11	1x15



8 - 3/4"



SET DE CLEȘTI PENTRU DECONECTAREA CONDUCTEI PRINCIPALE DE COMBUSTIE



53445	12	48
11,25€	3x5	1x11



CLEȘTE PENTRU EXTRAGEREA CLIPSURILOR DE PLASTIC DE CAROSERIE



53385	0,15	6	54	499
14,50€	Kg	3x5	1x11	1x15



CUT



EXTRACT



BRIDGE



Sfat unghiular:
conceput pentru a extrage / tăia capse /
cleme cu ușurință și fără deteriorări. Permite
accesul liber la zonele limitate.

SET DE CLEȘTI CU VÂRF DE 0°, 45°, 90°

52272	
22,80€	
Kg	1,00
3x5	5
1x11	20
1x15	320

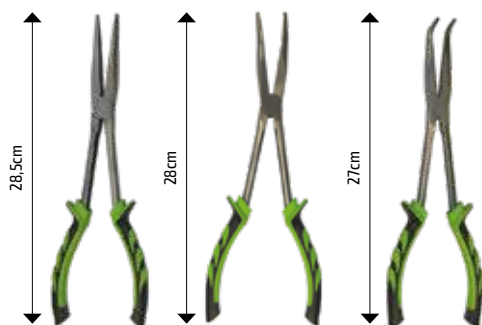

SET DE 5 CLEȘTI

51812	1,45	5	10	240
29,00€	Kg	3x5	1x11	1x15

Patent universal de 180mm
Clește pentru tăiat de
160mm
Clește cu cioc de 200mm
Clește papagal reglabil
de 250mm
Clește pentru dezizolat
cabluri de 160mm



CLEȘTE DE SIGURANȚĂ VÂRF DREPT

INTERIOR

52964	0,23	6	60	1.260	9"	225mm
9,00€	Kg					

51018	0,15	10	100	1.400	7"	180mm
4,80€	Kg					

EXTERIOR

52966	0,25	6	60	1.440	9"	225mm
9,00€	Kg					

51017	0,13	10	100	1.400	7"	180mm
4,80€	Kg					



CLEȘTE DE SIGURANȚĂ VÂRF CURBAT

INTERIOR

52965	0,24	6	60	1.440	9"	225mm
9,00€	Kg					

51021	0,16	10	100	1.400	7"	180mm
4,80€	Kg					

EXTERIOR

52967	0,24	6	60	1.440	9"	225mm
9,00€	Kg					

51020	0,13	10	100	1.400	7"	180mm
4,80€	Kg					



SET DE CLEȘTI SEGER CU VÂRF INTERSCHIMBABIL

N

53389	1,5	10	160	26 PES	10"
22,30€	Kg				

Unghiul vîrfurilor:
90° / 45° / 15° / 0°

Conține:
Clești interne, clești exteriori, 16 vîrfuri
de unghiuri diferite, 8 șuruburi



SET DE 3 CLEȘTE REGLABIL AUTOBLOCANT

52982	1,58	8	400
42,30€	Kg		

37cm : vîrf drept
36cm : unghi 45°
34cm : unghi 90°

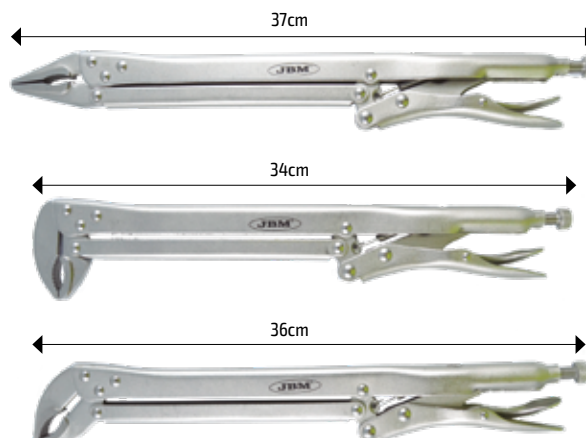

CLEȘTE EXTRALUNG SISTEM FOARFECĂ-DREPT

52846	0,40	60	1.500	
37,80€	Kg			

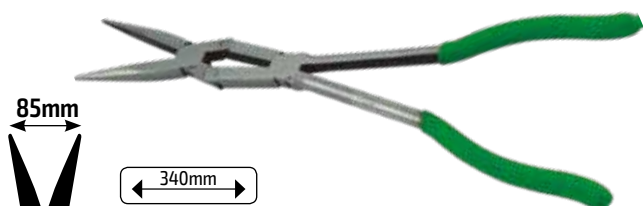

CLEȘTE EXTRALUNG SISTEM FOARFECĂ-CURBAT

52847	0,40	60	1.500	
37,80€	Kg			



PATENT UNIVERSAL

52276	0,24	6	60	1.920	160mm	
7,70€	Kg					6"



52277	0,31	6	60	1.920	180mm	
8,70€	Kg					7"



52278	0,38	6	60	1.920	200mm	
9,20€	Kg					8"



PATENT DE TĂIAT DIAGONAL

52281	0,13	6	60	2.400	140mm	
6,70€	Kg					5"



52282	0,20	6	60	1.920	160mm	
6,90€	Kg					6"



52283	0,26	6	60	1.920	184mm	
7,90€	Kg					7"



PATENT CU FĂLCI LUNGI

52284	0,16	6	60	1.920		
7,40€	Kg					

160mm	
6"	



PATENT CU VÂRF ALUNGIT

52279	0,15	6	60	1.920	160mm	
6,70€	Kg					6"



52280	0,24	6	60	1.920	200mm	
7,90€	Kg					8"



CLEȘTE REGLABIL TIP PAPAGAL

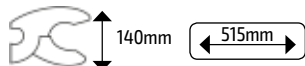

52052	1,88	10	400	
39,00€	Kg			



50567	0,34	10	60	1.000	
9,60€	Kg				



JOC DE 6 MINI CLEȘTI DE 120mm

50580					
9,60€	Kg	0,47			
		5			
		40			
		1.200			



Patent Universal
Clește cu vârf
Clește de tăiat
Clește dezizolat cabluri
Clește de siguranță
Patent Universal lat



SET DE CLEȘTI PENTRU COLIERE

52050	3,24	4	72
86,00€			

Clești pentru coliere elastice care permit extragerea colierelor auto-ajustabile din plastic și/sau din metal cu diametru de 18mm până la 47mm. Clești pentru coliere cu cap rotativ cu formă "+"
 Clești pentru coliere elastice cu cap rotativ.
 Clești pentru coliere cu bandă lată. Vârful se rotește la 360° pentru a putea apuca din orice unghi. Pentru clești moderni.
 Clești pentru extragerea de tuburi. Foarte utile pentru extragerea ușoară a tuburilor goale și combustibil de 5/32" până la 1/2".
 Clești pentru coliere și inel click-R. Utilizat pentru a slăbi și regla coliere ajustabile de tip click sau click-R.



B C F G E D

REF.	DESCRIERE				€
13707	CLEȘTE PENTRU COLIERE ELASTICE CU VÂRF ROTATIV	0,25	10	40	8,10€
13708	CLEȘTE PENTRU COLIERE ELASTICE	0,25	10	40	8,00€
13709	CLEȘTE PENTRU COLIERE ELASTICE CU VÂRF DREPT	0,24	10	40	8,00€
13710	CLEȘTE PENTRU COLIERE ELASTICE 45°	0,21	10	40	8,90€
52791	CLEȘTE PENTRU COLIERE "CLIC" Y "CLIC-R"	0,24	10	40	16,00€
13712	CLEȘTE PENTRU EXTRAGERE TUBURILOR	0,21	10	40	9,30€
51995	CLEȘTE PENTRU COLIERE ELASTICE	0,59	5	40	19,50€



CLEȘTE PENTRU COLIERE ELASTICE

51995			
19,50€			
	0,59		
	5		
	40		
	480		

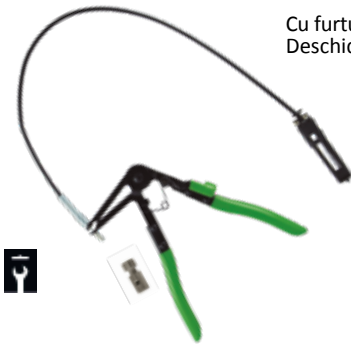

Cu furtun flexibil de: 630 mm
 Deschidere de: 47 mm



CLEȘTE PENTRU COLIERE ELASTICE

53390	10	20
25,95€		



CLEȘTE PENTRU COLIERE TIP URECHE

52812	0,87	10	20	500
49,90€				



Utilaj specific pentru strângerea clemelor de transmisie a burdufurilor de siguranță în mod sigur și eficient, fără efort.

CLEȘTE PENTRU COLIERE ALE ȚEVILOR DE EȘAPAMENT

53396	25	50
13,70€		



CLEȘTE PENTRU COLIERE TIP URECHE

52619		
23,10€		

	0,56
	6
	36
	648



Fiecare mâner are un pătrat de 1/2" pentru a putea fi utilizat cu o cheie dinamometrică și bară de fixare pentru vehiculele care necesită o strângere specifică a colierelor.

CLEȘTE PENTRU COLIERE CLICK-R

52791	0,27	10	50	1.500
16,00€				

Pentru tipul de Clic și Clic-R (tip cerc)

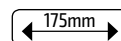

CLEȘTE PENTRU STRÂNS ARCUL LA SABOȚII DE FRÂNĂ

52625	0,32	6	48
7,00€	Kg	sub	ff

Para extraer e instalar resortes de retorno en frenos de tambor



CLEȘTE SPECIAL PENTRU FRÂNE

52389	0,32	5	50	600
26,20€	Kg	sub	ff	ff

Pentru a putea separa pistonul de frâna de disc în sistemele de frânare la motocicletă și vehicule.



CLEȘTE SPECIAL PENTRU FRÂNE

52508	0,32	10	50	800	0-38mm
32,30€	Kg	sub	ff	ff	ff
52509	0,39	10	50	800	22-55mm
33,60€	Kg	sub	ff	ff	ff

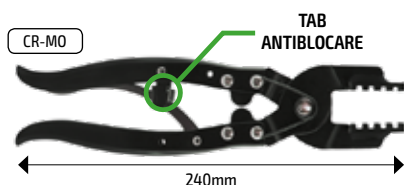

CLEȘTE PENTRU VULCANIZARE

51355	0,45	10	50	500
14,90€	Kg	sub	ff	ff



Extrage ușor și înlocuiește greutatea. Taie și îndoaie cu ușurință. Din oțel, rezistent la căldură. Include mâner ergonomic. Include arc de deschidere pentru a ușura utilizarea acestuia.



ALUMINIU ALIAJ TEAVA INSURUBAT

53070	0,68	6	24	12"	270mm	45mm
13,50€	Kg	sub	ff			
53071	0,92	6	24	14"	320mm	50mm
17,60€	Kg	sub	ff			
53072	1,41	6	12	18"	410mm	65mm
25,30€	Kg	sub	ff			
53073	2,12	2	8	1.000	540mm	75mm
38,30€	Kg	sub	ff			



CHEIE ȚEVI STILLSON

52235	0,85	5	50	1.140	12"	300mm	50mm
9,30€	Kg	sub	ff				
52236	1,09	5	20	760	14"	350mm	55mm
10,60€	Kg	sub	ff				
52237	0,30	4	12	720	18"	450mm	60mm
14,10€	Kg	sub	ff				
52238	3,08	2	8	600	24"	600mm	75mm
21,20€	Kg	sub	ff				
53210	4,45	4			36"	915mm	110mm
30,90€	Kg	ff					N



TĂIETOR DE JOJE

52955	0,77	20	200	300mm
15,10€	Kg			12"

52956	0,95	20	200	350mm
17,95€	Kg			14"

52957	1,47	12	204	450mm
21,50€	Kg			18"

52958	2,41	8	168	600mm
28,50€	Kg			24"

52959	3,78	5	100	750mm
38,65€	Kg			30"

52960	4,75	4	96	900mm
47,05€	Kg			36"



MENGINĂ DE MÂNĂ 11 DIFERITE DIMENSIUNI

52349	1,25	10	480	90x200mm
12,30€	Kg			

52350	1,41	10	540	90x300mm
13,90€	Kg			

52351	1,60	10	480	90x400mm
15,20€	Kg			

52352	1,99	10	360	120x300mm
18,60€	Kg			

52353	2,20	10	350	120x400mm
20,30€	Kg			

52354	2,41	10	300	120x500mm
21,80€	Kg			

52355	2,62	10	300	120x600mm
23,40€	Kg			

52356	4,12	5	250	150x600mm
33,10€	Kg			

52357	4,75	5	125	150x800mm
37,20€	Kg			

52358	1,99	5	120	150x1000mm
41,30€	Kg			

52359	5,96	6	120	150x1200mm
45,60€	Kg			



SET PENTRU EXTRAS GARNITURI 2PCS

52852	0,07	25	100
3,70€	Kg		

Pentru extragerea oringurilor



CLEȘTE DE PERFORAT ROTATIV

52638	0,26	5	30	200
5,00€	Kg			

\varnothing 2, 2.5, 3, 3.5, 4, 4.5mm



SET DE 12 PREDUCELE

METRIC

52885	1,10	10	20	600	3, 4, 5, 6, 7, 8, 9, 10, 12, 14, 16, 19mm
16,20€	Kg				

INCH

52759	1,12	10	20	600	1/8", 5/32", 3/16", 7/32", 1/4", 5/16", 3/8", 7/16", 1/2", 9/16", 5/8", 3/4"
14,10€	Kg				





03



MOBILIER

CĂRUCIOARE CU SCULE	58
ACCESORII	62
DULAPURI	62
MESE DE LUCRU	65
CUTIE PENTRU SCULE	67
GEANTĂ / GHIOZDAN	68
NICOVALĂ / MENGHINĂ FIXĂ	69
BANCHETĂ	70
TARGĂ	70

CĂRUCIOR DOTAT CU SCULE ȘI UNELTE

N



ANTIALUNECARE!

53035	71,00	1	2
859,00€	Kg		

53036	71,00	1	2
859,00€	Kg		

53113	71,00	1	2
859,00€	Kg		

53461	53,00	1	2	VID
570,00€	Kg			

53462	53,00	1	2	VID
570,00€	Kg			

53034	53,00	1	2	VID
570,00€	Kg			

siguranță cu cheie.
Colțuri protejate cu cauciuc foarte rezistent.



SERTARE CU BUTON

SUPRAFAȚĂ ANTI-ALUNECARE

TAVA PENTRU SPRAYS

ROȚILE CU SISTEM DE FRÂNARE

DIMENSIUNI

924mm	710mm	470mm
-------	-------	-------

SERTAR MIC (x5)

60mm	534mm	400mm
------	-------	-------

SERTAR MIJLOCIU (x1)

120mm	534mm	400mm
-------	-------	-------

SERTAR MARE (x1)

200mm	534mm	400mm
-------	-------	-------

CU EVA MODULE:



11997

11996

11998

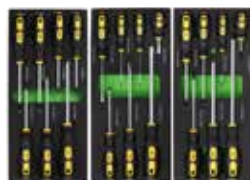

12001

11999

12000



12002

12006

13884



53116



12007

12005

13670

REF.	CARACTERISTICI		€
11993	Tubulare 1/2"	10	73,40€
11994	Tubulare 1/4"	10	30,70€
11995	Chei tub. cu cot Eva	10	51,00€
11996	Chei fixe	10	48,00€
11997	Chei cotate	10	45,60€
11998	Chei combinate	6	68,70€
11999	Șurubelnițe late	10	19,70€
12000	Șurubelnițe inelare	10	18,60€
12001	Șurubelnițe late Torx	10	19,40€

REF.	CARACTERISTICI		€
12002	Ciocane	10	26,30€
12003	Dălți și perforatoare	10	40,70€
12004	Chei în "T"	10	19,30€
12005	Clește + patent	10	28,60€
12006	Clești seger	10	25,70€
12007	Clești	10	27,20€
13670	Modul cu pile	10	12,65€
13884	Modul gol, fara instrumente	-	9,00€
53116	Modul de tubulare hexagonale cu 108 piese	3	99,50€

CĂRUCIOR CU SCULE CU BARĂ TELESCOPICĂ

CU DOTARE EVA*

52705	80	1	2
850,00€	Kg	ff	ff

52825	80	1	2
850,00€	Kg	ff	ff



DIMENSIUNI EXTERIOR

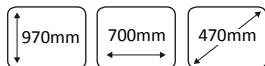

DIMENSIUNI INTERIOR

SERTARE MICI (x5)

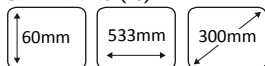

SERTAR MIJLOCIU (x1)

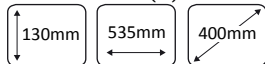

SERTAR MARE (x1)

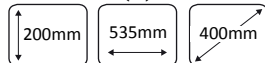

*MODULE EVA 175x30x380mm

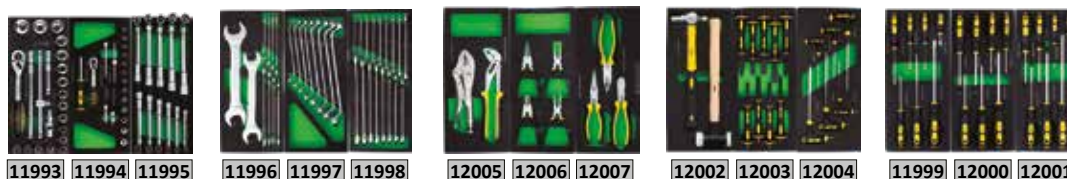

11993 11994 11995

11996 11997 11998

12005 12006 12007

12002 12003 12004

11999 12000 12001

CĂRUCIOR CU SCULE ȘI UNELTE CU DOTARE CU BARĂ TELESCOPICĂ

52704	80	1	2
790,00€	Kg	ff	ff

52764	80	1	2
790,00€	Kg	ff	ff



DIMENSIUNI EXTERIOR

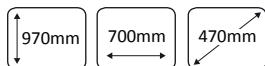

DIMENSIUNI INTERIOR



SERTAR MIJLOCIU (x1)

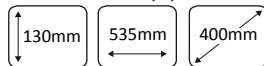

SERTAR MARE (x1)

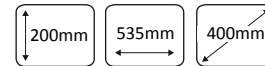

10728 10729 10730

10680 10727 10736

10676 10677 10678

10679 10726 10735

10731 10732 10733

53117

REF.	CARACTERISTICI	ff	€
10728	Chei cot: 6x7mm a 18x19mm + 0x22mm	10	37,90€
10729	Chei combinate: 6 a 22mm	10	52,00€
10730	Chei fixe: 6x7mm a 20x22mm + 27x27mm + 30x32mm	6	44,50€
10680	Ciocan cu cap de nailon și ciocan cu cap semirodund	10	20,70€
10727	Clești mini Seger 6": vârf drept A, vârf drept C, curbat A, curbat C	10	18,60€
10736	Modulul de 12 bay-uri goale	10	6,00€
10676	Șurubelnițe late: 3.0x75, 3.5x75, 4.0x100, 5.5x100, 6.5x150, 8.0x175mm	10	16,90€
10677	Șurubelnițe inelare: 0x75, 1x100, 2x38, 2x100, 2x125, 3x150, 4x200mm	10	19,60€

REF.	CARACTERISTICI	ff	€
10678	Șurubelnițe torx: 10x75, 15x75, 20x100, 25x100, 27x100, 30x125, 40x150mm	10	16,90€
10679	3 clești: universal 8", clește vârf drept 8", clește de tăiat 7,5"	10	21,60€
10726	Clește de presiune 10" + clește cu clemă reglabilă	10	22,80€
10735	Pile cu mâner: pătrat, triunghiular, rotundă, lamă și semilună	10	17,20€
10731	Modul clește nituit + nituri pentru cărucioare cu scule	10	13,30€
10732	Măsură	10	16,60€
10733	Dezizolat + tăiat cablu	10	20,20€
53117	Modul de plastic 108 piese cu tubulare hexagonale	3	93,50€

53195	58,98	1	2
498,00€	Kg		



MĂSURĂTORI:

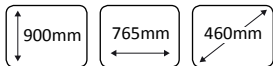

SERTAR MARE (x2)

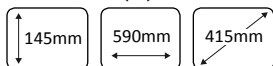

SERTAR MIC (x4)

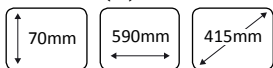

ROATA CU SISTEM DE FRÂNARE



SERTARE CU GHID TELESCOPIC



SIGURANȚĂ CU CHEIE



53117
108
PCS



10679 **10726** **10680**
3 **2** **2**
PCS PCS PCS



10676 **10677** **10678**
7 **7** **7**
PCS PCS PCS



10728 **10730** **10729**
8 **17** **17**
PCS PCS PCS

REF.	CARACTERISTICI			€
53117	Modul cu tubulare hexagonale	3	84	93,50€
10679	3 Clești	10	220	21,60€
10726	Clești nituit + nituri	10	220	22,80€
10680	Ciocane	10	300	20,70€
10676	șurubelnițe late	10	220	16,90€

REF.	CARACTERISTICI			€
10677	șurubelnițe inelare	10	220	19,60€
10678	șurubelnițe torx	10	220	16,90€
10728	Chei cotite	10	220	37,90€
10730	Chei fixe	6	300	44,50€
10729	Chei combinate	10	220	52,00€

CĂRUCIOR CU 7 SERTARE CU BARĂ TELESCOPICĂ CU ȘI FĂRĂ DOTARE

FĂRĂ SCULE

52172	58	1	2
378,00€	Kg		

CU SCULE ASORTATE

52393	69,5	1	2
650,00€	Kg		



CU COVORAȘ DIN CAUCIUC ANTI-ALUNECARE



ÎNCHIDERE CU CHEIE



ROȚILE CU FRÂNELE



DIMENSIUNI EXTERIOR

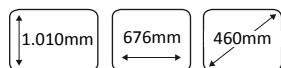

DIMENSIUNI INTERIOR

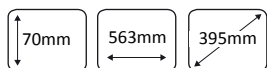

SERTARE MICI (x5)

DIMENSIUNI INTERIOR

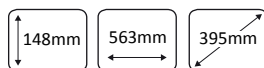

SERTARE MARI (x2)

MODULE INCLUSE 175x45x380mm



10728 10729 10730



10680 10727 11118



10676 10677 10678



10679 10726 10735



53116

REF.	CARACTERISTICI		€
10728	Chei cu cot: 6x7mm A 18x19mm + 0x22mm	10	37,90€
10729	Chei combinate: 6 a 22mm	10	52,00€
10730	Chei fixe: 6x7mm a 20x22mm + 27x27mm + 30x32mm	6	44,50€
10680	Locan cu cap de nailon și cu cap semirotond	10	20,70€
10727	Clești mini Seger 6": vârf drept A, vârf drept C, curbat A, curbat C	10	18,60€
11118	Modulul de bay-uri goale	10	4,50€
10676	Șurubelnițe late: 3.0x75, 3.5x75, 4.0x100, 5.5x100, 6.5x150, 8.0x175mm	10	16,90€
10677	Șurubelnițe inelare: 0x75, 1x100, 2x38, 2x100, 2x125, 3x150, 4x200mm	10	19,60€
10678	Șurubelnițe torx: 10x75, 15x75, 20x100, 25x100, 27x100, 30x125, 40x150mm	10	16,90€
10679	3 clești: universal 8", clește vârf drept 8", clește de tăiat 7,5"	10	21,60€
10726	Clește de presiune 10" + clește cu clemă reglabilă	10	22,80€
10735	Pile cu mâner: pătrat, triunghiulară, rotundă, lamă și semilună	10	17,20€
53117	Modul de plastic 108 piese cu tubulare hexagonale	3	93,50€

**ACCESORII (NU INCLUSE) PENTRU REF. 52705,
52825, 52704, 52764, 52826, 53035, 53036, 53113, 53461, 53462, 53034**



**BUZUNAR
PT. DOCUMENTE**

51431	2,11	5
12,30€		



**SUPORT PENTRU
RESTURI**

51432	2,00	5
40,30€		



**TAVĂ LATERALĂ PENTRU
SPRAYS**

12985	0,35	6
10,10€		



**DULAP AUXILIAR
LATERAL**

51435	4,83	2
90,60€		



**SUPORT TAVĂ + SUPORT
HÂRTIE**

51436	1,19	4
33,40€		



**DUBLU PERETE
SUPERIOR**

51430	0,55	2
108,90€		



**SERTAR SPRAY PENTRU
SERIA ANTIALUNECARE**

13940	0,35	6
14,20€		



**SERTAR DOCUMENTE
PENTRU SERIA
ANTIALUNECAR**

13941	2,11	6
18,30€		



**SERTAR RULOURI
PENTRU SERIA
ANTIALUNECARE**

13942	1,19	6
30,50€		



**COȘ PENTRU HÎRTIE
PENTRU SERIA
ANTIALUNECARE**

13943	2,00	6
29,50€		



**MODUL GOL DE 15
COMPARTIMENTE**

13944	-	2
19,50€		

**CĂRUCIOR DULAP CU 9 SERTARE CU SEPARATOARE
METALICE DETAȘABILE ȘI BARE TELESCOPICE**

52360	72,5	1	2
550,00€			



DULAP

1.010mm	760mm	460mm
---------	-------	-------

SERTARE

60mm	570mm	395mm
------	-------	-------

DIMENSIUNI SEPARATOARE



50 x 56mm

11205	1,80€
--------------	--------------

96 x 56mm

11206	1,80€
--------------	--------------

142 x 56mm

11207	2,50€
--------------	--------------

189 x 56mm

11208	3,10€
--------------	--------------

235 x 56mm

11209	4,80€
--------------	--------------

280 x 56mm

11210	4,80€
--------------	--------------

396 x 56mm

11211	6,90€
--------------	--------------

JOC DE 4 ROȚI PENTRU DULAP REF.52360

ø12cm
2 Roți cu frână + 2 roți simple

11313	4,11	1
42,00€		



DULAP DE LUCRU MULTIMEDIA CU ROȚI

51456	42,5	1	2
495,00€	Kg		

EXTERIOR

1165mm	575mm	458mm
--------	-------	-------

SERTARE SUPERIOR

70mm	570mm	425mm
------	-------	-------

DULAP INFERIOR

148mm	670mm	395mm
-------	-------	-------

DISTANȚĂ ÎNTRE RAFTURI

190mm	305mm	250mm
-------	-------	-------

JOC DE 4 ROȚI PENTRU DULAP REF.51456

ø12cm
2 Roți cu frână + 2 roți simple

11313	4,11	1
42,00€	Kg	



CĂRUCIOR CU DUBLĂ COLUMNĂ DE 12 SERTARE

Cărucior cu 12 sertare

51427	108,00	1	1000mm	1060mm	580mm
890,00€	Kg				

53546	126,00	1
1.525,20€	Kg	

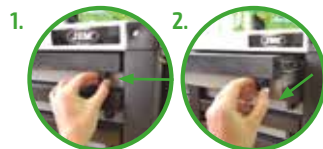

BLOCARE INDIVIDUALĂ

DIMENSIUNI INTERIOR 1a COLUMNĂ

55mm	530mm	395mm
------	-------	-------

SERTARE MICI (x3)

125mm	530mm	395mm
-------	-------	-------

SERTAR MIJLOCIU (x2)

195mm	530mm	395mm
-------	-------	-------

SERTAR MARE (x1)

DIMENSIUNI INTERIOR 2a COLUMNĂ

55mm	265mm	395mm
------	-------	-------

SERTARE MICI (x3)

125mm	265mm	395mm
-------	-------	-------

SERTAR MIJLOCIU (x2)

195mm	265mm	395mm
-------	-------	-------

SERTAR MARE (x1)

CU DOTARE EVA*



53116



12007

12002

12005

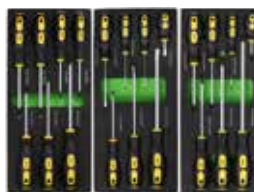

51378

51380

51381



11997

11996

11998

CROMAT

fără TVA

JBM

WWW.JBMCAMP.COM

JBM 2018

63

DULAPURI

CARRITO CU 4 ȘI 6 SERTARE

4 SERTARE

51426	36	1	4
440,00€	Kg		

550mm	680mm	460mm
-------	-------	-------



51426

BLOCARE INDIVIDUALĂ



6 SERTARE

51425	39,50	1	3
530,00€	Kg		

700mm	460mm	680mm
-------	-------	-------



51425

CARUCIOR CU 1 SERTARE CU BARĂ TELESCOPICĂ

52826	33	1	2
348,00€	Kg		

SUPORT SEPARATOR



SUPRAFAȚĂ ANTI-ALUNECARE



COLȚURI PROTEJATE CU CAUCIUC FOARTE REZISTENT

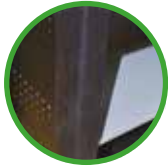

ÎNCHIDEȚI CU FLANȘĂ



DIMENSIUNI EXTERIOR

970mm	700mm	470mm
-------	-------	-------

DIMENSIUNI SERTARE INTERIOR

125mm	530mm	400mm
-------	-------	-------



CĂRUCIOR MOBIL PENTRU SCULE CON 3 BANDEJAS

51576			
88,00€			
Kg	16,35		
	1		
	22		

100Kg



CĂRUCIOR MOBIL PENTRU SCULE CU 3 TĂVI MAXI

52373			
135,00€			
Kg	24,70		
	1		
	10		

150Kg



SUPORT DE PERETE TIP CÂRLIG PENTRU REF. 51430 (NU INCLUDE)



CÂRLIG 1 VÂRF SCURT

40mm

51974	0,02	100
1,40€	Kg	



CÂRLIG 1 VÂRF SCURT FOND

30mm

51975	0,03	100
1,40€	Kg	



CÂRLIG 2 VÂRFURI LUNGI

75mm

51976	0,03	100
2,20€	Kg	



CÂRLIG LUNG ÎNCHIS

75mm

51977	0,02	100
2,50€	Kg	

TABLĂ PERFORATĂ PANOURI

52419	7,49	1	38
58,00€	Kg		

52420	10,80	1	35
69,00€	Kg		

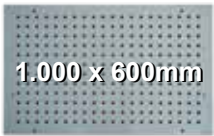

52421	14	1	38
98,00€	Kg		

PĂȘĂTOR PĂTRAT

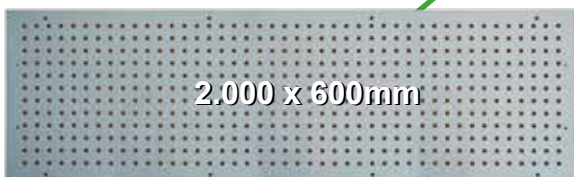

MASĂ DE LUCRU CU PANOU DE SCULE

51035			
530,00€			
Kg	86,50		
	1		
	5		



CÂRLIGE PENTRU REF. 51035 ȘI PENTRU TABLĂ PERFORATĂ PANOURI REF. 52419, 52420, 52421

51654	0,09	10	275
3,60€	Kg		

CÂRLIG VÂRF ÎNCHIS



51658	0,05	80	275
3,60€	Kg		

CÂRLIG 2 VÂRFURI LUNGI



51655	0,07	10	150
3,70€	Kg		

CÂRLIG 2 VÂRFURI SCURTE



52634	0,14	150	
3,70€	Kg		

CÂRLIG 2 VÂRFURI EXTRA LUNGI



51656	0,07	10	250
3,80€	Kg		

CÂRLIG VÂRF LUNG



52635	0,14	275	
3,60€	Kg		

CÂRLIG VÂRF ÎNCHIS EXTRA LUNG



SUPORT SPECIAL PENTRU CHEI

51653	0,28	1	
6,90€	Kg		

Pentru ref.: 51035, 52419, 52420, 52421



SUPORT SPECIAL PENTRU ȘURUBELNIȚE

51657	0,30	50	1.000
7,90€	Kg		

Pentru ref.: 51035, 52419, 52420, 52421



CÂRLIGE PENTRU

51418	0,03	100	
2,30€	Kg		

CÂRLIG 1 VÂRF SCURT



51420	0,03	100	
2,90€	Kg		

CÂRLIG 1 VÂRF SCURT FOND



51419	0,03	100	
2,90€	Kg		

CÂRLIG 1 VÂRF LUNG



51421	0,02	100	
3,20€	Kg		

CÂRLIG 2 VÂRFURI SCURTE



51422	0,05	100	
3,60€	Kg		

CÂRLIG 2 VÂRFURI LUNGI







51423	0,04	100	
3,80€	Kg		

CÂRLIG VÂRF ÎNCHIS

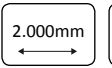







MASĂ DE LUCRU CU 3 SERTARE

51738	81,50	1	5	  
495,00€	Kg		 	



MASĂ DE LUCRU CU 2 SERTARE

51737	65,50	1	5	  
426,00€	Kg		 	



MASĂ DE LUCRU







N

53193	44,70	1	
366,00€	Kg		

Capacitatea maximă a sertarului: 25kg.



MASĂ DE LUCRU CU 4 SERTARE INFERIOARE CU PERSIANĂ PLIANTĂ

51428	138	1	2	  
1.050,00€	Kg		 	

CU PERSIANĂ PLIANTĂ



TABLĂ PERFORATĂ PANOURI

4 SERTARE INFERIOARE

750mm

CUTIE PENTRU SCULE CU 6 COMPARTIMENTE

51574	0,56	1	35			
29,00€	Kg					



CUTIE PENTRU SCULE 75cm

N

53222	6,285	1	25			
47,60€	Kg					



CUTIE PENTRU SCULE CU 3 SERTARE FRONTALE

51600	7,69	1	18			
66,00€	Kg					

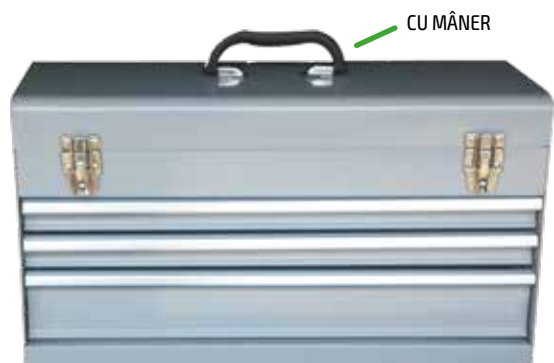

CUTIE PENTRU SCULE CU 4 SERTARE

51575	19,75	1	6			
184,00€	Kg					

Sertare mari: lățime 570mm
Sertare mici: lățime 180mm



CUTIE PENTRU SCULE CU 3 SERTARE FRONTALE + SUPERIOR

51599	8,47	1	18			
79,00€	Kg					



ACCESORII

GEANTĂ PENTRU UNELTE

N

53252	1,80	4	16
42,50€	Kg		

300mm	465mm	250mm
-------	-------	-------

CU MÂNERUL ACOPERIT DE SPUMA PENTRU TRANSPORTUL SAU COMOD

600D polyester.
Nu include instrumente.

15Kg/2BL



VALIZA PENTRU UNELTE

N

53253	4,50	2	12
119,40€	Kg		

430mm	360mm	250mm
-------	-------	-------

600D Polyester.
Nu include instrumente.

20Kg/1BL



GHOZDAN PENTRU SCULE

N

53258	2,60	2	32
75,40€	Kg		

Nu include instrumente.

15Kg

550mm
360mm
230mm



NICOVALĂ PROFESIONALĂ

FIER

52306	10,17	1	100	285 x 85 x 143mm
50,00€	Kg			

52307	25	1	50	365 x 103 x 165mm
118,00€	Kg			



OȚEL

52308	50	1	20	625 x 140 x 190mm
369,00€	Kg			

52309	100	1	9	790 x 180 x 245mm
733,00€	Kg			



MENGHINĂ FIXĂ

51570	15,02	1	48	100mm
135,00€	Kg			

51572	28,95	1	28	150mm
278,00€	Kg			



MENGHINĂ CU BAZA ROTATIV

53031	5,78	1	168	4"	100mm
45,50€	Kg				

53032	13,71	1	60	6"	150mm
98,70€	Kg				



MENGHINĂ FIXĂ

52869	4,96	4	168	100mm
47,90€	Kg			

52870	12,12	1	72	150mm
102,20€	Kg			

52871	24,50	1	28	150mm
230,00€	Kg			

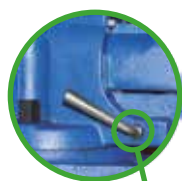

DESCHIDERE IMEDIATĂ
PRIN LEVIER + BAZA ROTATIV

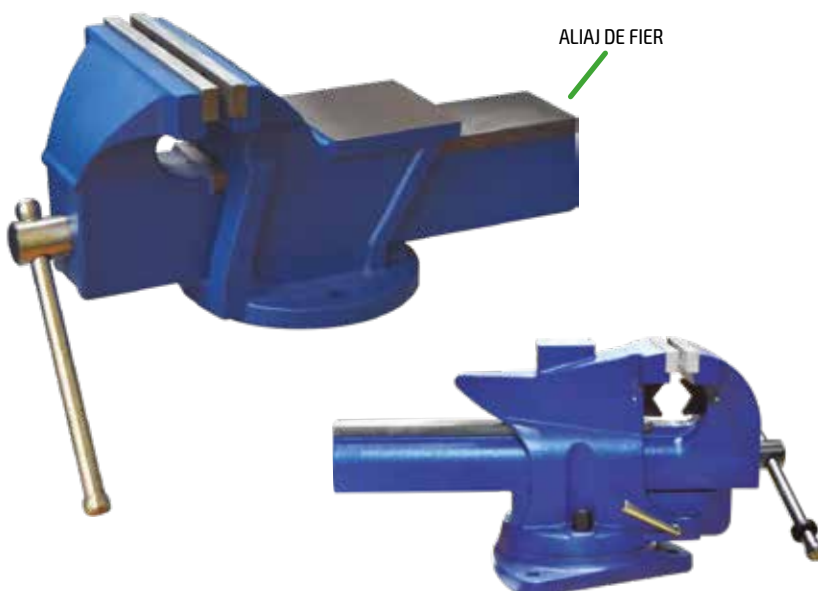

SCAUN REGLABIL PNEUMATIC

50843	5,61	1	36
54,00€	Kg		

575mm	380mm	380mm
-------	-------	-------

Min: 420mm
Max: 540mm



BANCHETĂ CU ROTILE

50844	4,09	1	50
42,00€	Kg		

360mm
440mm
350mm



TARGĂ SERVICE DIN PLASTIC

52148	4,72	1	19
54,00€	Kg		

Plastic de mare densitate
Roți reforțate din cauciuc
Foarte rezistentă

150Kg



120mm	1.020mm	480mm
-------	---------	-------

TARGĂ SERVICE AUTO METALICĂ

50808	5,63	1	24
48,00€	Kg		

105mm	930mm	440mm
-------	-------	-------



TARGĂ SERVICE AUTO

N

53211	5,40	1	36
54,00€	Kg		

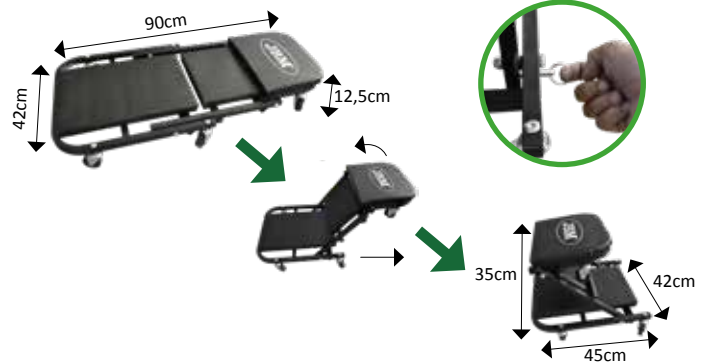

TARGĂ SERVICE AUTO

52542	12,70	1	17
110,00€	Kg		

150Kg



CU 7 ROTI

100mm	1.200mm	390mm
620mm	600mm	450mm



DIN OȚEL
ȘI SCAUNE PVC

ECHIPAMENTE DE LUCRU



04

A white line-art icon of a circular light fixture with several small circles representing LEDs arranged in a pattern. It is positioned to the left of the section header.

ILUMINARE

LANTERNĂ DE LUCRU PORTABILĂ	72
PROIECTOR PORTABIL	75
LUPĂ LED	75
LAMPĂ PORTABILĂ PENTRU CAPOTĂ.	75
LAMPĂ DE CONTROL.	76
APARAT PENTRU REGLAT FARURI	76
GIROFARURI	77
AVERTIZOR ACUSTIC AUTO	79
PROIECTOARE PĂTRATE	80
BARĂ PENTRU REMORCĂ.	83
BECURI PENTRU AUTOTURISME	84
LAMPI BUZUNAR	86

LANTERNĂ DE LUCRU PORTABILĂ LED

N

53431	0,35	10	40	400
33,70€	Kg	Sub	1f	

300 Lm | 7 LED SMD | Li-Ion 3.7V 2.000MA | 3-4H | 3-15H

53432	0,35	10	40	400
37,70€	Kg	Sub	1f	

500 Lm | 11 LED SMD | Li-Ion 3.7V 4.000MA | 6-7H | 3-15H

53433	0,35	10	40	400
45,10€	Kg	Sub	1f	

1.000 Lm | 13 LED SMD | Li-Ion 3.7V 4.400MA | 6-7H | 2-3 min 600 LM | 2-5W 500 LM



53431 53433 53432



LANTERNE PORTABILE

LANTERNĂ DE LUCRU PORTABILĂ LED 200LM

N

53439	0,25	10	50	600
24,65€	Kg	Sub	1f	



200 Lm | 2-3H | 2,5/5H | IP20 | Li-Ion 3.7V 650MA | 7 LED SMD | 1,5m | Magnet | Hook | Cables



LAMPĂ PORTABILĂ COB

N

53217	0,30	20	620
37,60€	Kg	1f	



200 Lm | LED 2W COB | 3.7V 2600MAH | 5V 1.000MA | 4H | 4H | Magnet | Hook | Cables

LAMPĂ PORTABILĂ CU BAZĂ ARTICULATĂ LED C.O.B. CU BATERIE REÎNCĂRCABILĂ

52523	0,44	10	360
46,00€	Kg	ft	ft



LAMPĂ DE LUCRU PORTABILĂ 24+6 LEDURI CU DUBLU MAGNET ÎN SPATE, SUPORT ȘI BAZĂ MAGNETICĂ

51889	0,43	10	360
35,00€	Kg	ft	ft



DUBLU CÂRLIG ȘI
DUBLU MAGNET

LAMPĂ PORTABILĂ SLIM LED C.O.B CU BATERIE REÎNCĂRCABILĂ

52536	0,40	10	330
42,00€	Kg	ft	ft

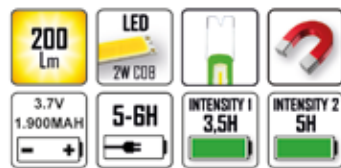

LAMPĂ EXTRAFINĂ CU LED C.O.B

52384	0,33	20	600
32,00€	Kg	ft	ft

Lungime cablu : 5m
DC Lungime cablu : 0,1 M
DC Lungime cablu la pensețe : 0,3M



LAMPĂ PORTABILĂ COB CU BAZĂ ARTICULATĂ

53216	0,60	10	120
47,25€	Kg	ft	ft

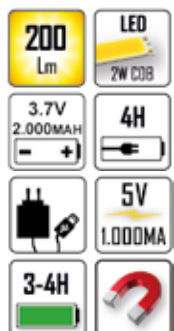

ADAPTOR ENGLEZESC PENTRU PRIZE

13816	0,50	-	-
0,60€	Kg	ft	ft



MINI LANTERNĂ CU 8 LEDURI MAGNETIZATĂ

52582	0,03	12	96	1.728
4,95€	Kg			



În interpret
12 unități



53427	0,05	12	96	3.072
3,20€	Kg			



În interpret
12 unități



LANTERNĂ PORTABILĂ CU BATERIE

52987	0,17	10	40	640
33,70€	Kg			

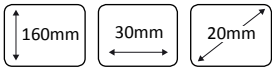

LAMPĂ PORTABILĂ COB CU BAZĂ ARTICULATĂ

52883	0,31	20	640
38,00€	Kg		



LANTERNĂ DE MÂNĂ 37 LEDURI CU BATERIE REÎNCĂRCABILĂ, MÂNER ARTICULAT ȘI MÂNER ROTATIV

52002	1,44	12	120
26,00€	Kg		



Până la 500 cicluri de sarcină
LED lumină albă, economisire de energie
Energetic, largă durată și luminozitate

LANTERNĂ FRONTALĂ CU ZOOM / LED CREE XP-E

52584	0,10	1	360
11,20€	Kg		



PROIECTOR PORTABIL LED

N

53199	0,80	18	270
40,05€	Kg	1f	1f



DIFUZOR BLUETOOTH



CÂRLIG DE FIXARE

LANTERNĂ

ÎNCĂRCĂTOR

DIFUZOR



LUPĂ LED DE MASĂ

N

53227	0,60	24	192
23,20€	Kg	1f	1f



LUPĂ LED (5X)

53085	0,31	10	40	1.500
24,00€	Kg	5b	1f	1f



2 POZIȚII

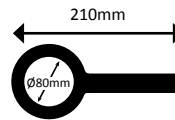

LAMPĂ PORTABILĂ PENTRU CAPOTĂ + SUPORT AJUSTABIL

51230	2,36	10	360	1825 Lm	230V 36W	360°	5m
95,10€	Kg	1f	1f				

Fluorescent înlocuibil
Suport extensibil



- 51232 62,20€**
PIESĂ DE SCHIMB PENTRU FLUORESCENT DE CAPOTĂ CU REF. 51230
- 11877 70,00€**
PIESĂ DE SCHIMB LAMPĂ, FĂRĂ SUPORT, PENTRU REF. 51230
- 11092 38,00€**
SUPORT DE SCHIMB PENTRU LAMPĂ PORTABILĂ CU REF. 51230

REF.	DESCRIERE	PENTRU REF.	Kg	1f	5b	1f	€
11107	ALIMENTATOR BRICHETĂ AUTO 100-240V OUTPUT: 6V 500MA	51889	0,06	-	10	360	4,00€
10961	ÎNCĂRCĂTOR DE REȚEA 100-240V OUTPUT: 6V 500MA	51889	0,08	-	10	360	12,00€
11989	ALIMENTATOR BRICHETĂ AUTO PENTRU PORTABILA DE LUCRU 100-240V OUTPUT: 9V 500MA	52536	0,04	-	10	360	4,00€
11093	ALIMENTATOR BRICHETĂ AUTO 230V OUTPUT: 6V 500MA	51453, 50650, 51648	0,06	-	10	360	4,00€



11107

10961

11989

11093

BARĂ LED PLEGABILĂ PENTRU CAPOTĂ

N



53248	2,55	4	32
115,25€	Kg		

1060Lm 2h	452Lm 4h	120 LEDS 5050 SMD	
---------------------	--------------------	-----------------------------	--

	7.4V 1.800MAH	6-8H	
--	------------------	------	--

138cm	185cm
-------	-------



ARTICULABIL

"STATIV" CU 3 PICIOARE PENTRU LAMPĂ DE CONTROL CU REF. 52232

Lampa nu este inclusă

52254	
48,30€	

Kg	3,51
	1
	4
	24

Min: 2.770mm
Max: 1.290mm

52255	
39,40€	

Kg	2,73
	1
	4
	80

Min: 1.700mm
Max: 930mm



CE

LAMPĂ DE CONTROL 55W PĂTRATĂ

52232	3,30	4	48
98,00€	Kg		

HQ75N/F 3x1.5mm 1,8m		x2
----------------------------	--	----

GR10Q



10982 15,00€
PIESĂ DE SCHIMB LAMPĂ DE CONTROL PENTRU REF. 52232

0,23	50
Kg	

2D 55W

CE

APARAT PENTRU REGLAT FARURI CU LUXOMETRU

52740	24	1	10
495,00€	Kg		

Distanță de măsurare: 50cm
Ușoară măsurare a devierilor axului optic a fazei lungi și a fazei scurte
Ghiduri de deplasare laterală opționale

HALOGEN / XENON / LED

156mm	52mm	28mm
-------	------	------



CE

APARAT PENTRU REGLAT FARURI CU DUBLU LASER ȘI LUXOMETRU

52836	24,85	1	10
890,00€	Kg		

HALOGEN / XENON / LED

ECRAN DE CONTROL



LUXOMETRO DIGITAL



DUBLU LASER

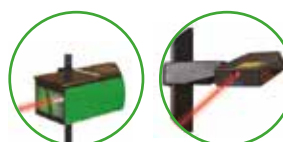

CE

GIROFAR LED CU BAZĂ FLEXIBILĂ



53454	0,65	20	240
45,95€	Kg	ff	ff

12V - 24V

45 PCS 2835 LED

Funcții:

Funcție 1: FLASH

Funcție 2: BLOCAREA DOUBĂ

Funcție 3: ROTAȚIE

CE R10 - R65



GIROFAR BAZĂ FLEXIBILĂ

51964	0,69	20	160
24,50€	Kg	ff	ff

51965	0,68	20	160
24,50€	Kg	ff	ff

Lentile ABS - BAES

Tulipas anti-rupere

Filetul obiectivului cu garnitura pe termen lung

Rpm: 40

Sistem de pinion / Sistem de vierme

Bec:

H1, 12V 55W

H1, 24V 70W

Bază cu filet

Consum energie: 3.0 A

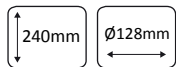

BAZĂ FLEXIBILĂ

**12V - 55W
24 - 70W**

CE R10 - R65

GIROFAR LED BAZĂ FLEXIBILĂ

53131	0,90	20	240
48,00€	Kg	ff	ff

12V - 24V

Lentile ABS-BAES

Tulipa anti-rupere

Consum: 14W

Funcții:

Funcție 1: ROTAȚIE

Funcție 2: BLIȚ DUBLU

Funcție 3: 6 CLIPEȘTE

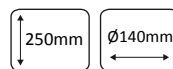

BAZĂ FLEXIBILĂ



R10 - R65 CE

Aprobat E9 10R-046919
CE R10-R65

GIROFAR LED BAZĂ FLEXIBILĂ

52549	0,71	20	200
62,00€	Kg	ff	ff

12V - 24V

Lentile de policarbonat

Tulipa anti-rupere

Consum: 17W

Funcții:

Funcție 1: UNU BLIȚ

Funcție 2: BLIȚ DUBLU

Funcție 3: ROTAȚIE



BAZĂ FLEXIBILĂ



ECE - R65 CE

GIROFAR FĂRĂ CABLU

51962	0,58	20	240
21,00€	Kg	ff	ff

**12V
35W**

51963	0,59	20	240
24,70€	Kg	ff	ff

**24V
55W**

Lentile ABS - BAES

Tulipas anti-rupere

Filetul obiectivului cu garnitura pe termen lung

Rpm: 40

Sistem de pinion / Sistem de vierme

Bec: H1, 12V 55W / H1, 24V 70W

Consum energie: 3.0 A



R10 - R65 CE

GIROFAR LED MAGNETIC



53455	0,70	20	240
49,40€	Kg	ff	ff

12V - 24V

45 PCS 2835 LED

Magnet

Priză brichetă

Funcții:

Funcție 1: FLASH

Funcție 2: BLOCAREA DOUBĂ

Funcție 3: ROTAȚIE

CE R10 - R65



GIROFAR INTERMITENT LED

52548	0,80	20	240
65,00€	Kg	ff	ff

12V

Lentile de policarbonat

Tulipa anti-rupere

Cablu: 4m + priză de brichetă auto

Consum: 17W

Debitul cu led

Funcții:

Funcție 1: UNU BLIȚ

Funcție 2: ROTAȚIE

Funcție 3: BLIȚ DUBLU

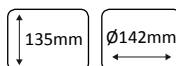

ECE - R65 IP:56 CE

GIROFAR INTERMITENT LED

53130	0,90	20	240
48,00€	Kg	ff	ff

12V - 24V

Lentile ABS-BAES

Tulipa anti-rupere

Cablu: spirala de 2,5m + priză de brichetă auto

Consum: 14W

Debitul cu led

Funcții:

Funcție 1: ROTAȚIE

Funcție 2: BLIȚ DUBLU

Funcție 3: 6 CLIPEȘTE

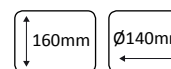

R10 - R65 CE

GIROFAR 12V SCURT MAGNETIC

52299	0,72	20	320
29,80€			

12 - 55V

DESIGN
COMPACT

Lentile ABS - BAES
Tulipa anti-rupere
Filetul obiectivului cu garnitura
permen lung
Rpm: 40
Sistem de pinion / Sistem de vierme
Bec H3, 12V 55W
Cablul: spirala de 3,5m + toma
brichetă auto
Consum energie: 3.0 A



130mm	Ø128mm
-------	--------

R10 - R65

GIROFAR LED BAZĂ FLEXIBILĂ

52456	0,59	20	160
41,00€			

12V - 24V

Lentile ABS-BAES
Tulipa anti-rupere
Consum: 8W
Funcții:
Funcție 1: ROTAȚIE
Funcție 2: BLIȚ DUBLU
Funcție 3: 6 CLIPEȘTE



190mm	Ø128mm	Ø24mm
-------	--------	-------

LED 6 ÎN 1

BAZĂ
FLEXIBILĂ



R10

FAR INTERMITENT

51966	0,31	50	750
18,00€			

12 - 110V

CU BAZA
TULIPEI
FILETATĂ

Lentile ABS - BAES
XENON
Consum energie: 3.0 A

131mm	Ø99mm	Ø61mm
-------	-------	-------



R10

GIROFAR CU CABLU MAGNETIC

51960	0,80	20	240
27,00€			

**12V - 55W
24 - 70W**

51961	0,78	20	240
28,00€			

Lentile ABS - BAES
Tulipas anti-rupere
Filetul obiectivului cu garnitura
pe termen lung
Rpm: 40
Sistem de pinion / Sistem de vierme
Bec: H1, 12V 55W / H1, 24V 70W
Cablul: spirala de 3m + priza de brichetă auto
Consum energie: 3.0 A

160mm	Ø128mm
-------	--------



R10 - R65

GIROFAR AGĂȚĂTOR RAPID

52300	0,63	20	200
32,00€			

12 - 55V

DESIGN
COMPACT

Lentile ABS - BAES
Tulipa anti-rupere
Filetul obiectivului cu garnitura pe termen lung
Rpm: 40
Sistem de antrenare a curelei
Bec: H3, 12V 55W
Pe baza mecanismului de cuplare rapidă
Consum energie: 3.0 A



210mm	Ø128mm
-------	--------

R10 - R65

GIROFAR INTERMITENT ROTATIV PROFIL REDUS

0,50	20	320

12V - 24V

Cu 3 comutatoare de funcție
3 moduri de intermitență:
ROTAȚIE
6 CLIPEȘTE
MODUL DUAL FLASH



52827
36,90€

52910
37,60€

52946
37,60€

52828
36,90€

95mm	129mm	85mm
------	-------	------

R10

GIROFAR INTERMITENT LED

52499	0,61	20	320
42,00€			

140mm	Ø128mm
-------	--------

Lentile ABS-BAES
Tulipa anti-rupere
Cablul: spirala de 2,5m + priza de brichetă auto
Consum: 3W

Funcții:
Funcție 1: ROTAȚIE
Funcție 2: BLIȚ DUBLU
Funcție 3: 6 CLIPEȘTE

R10

LED 6 ÎN 1



AVERTIZOR ACUSTIC AUTO ROTUND 12V-80V

51967	0,30	10	50	1.000
16,00€				

51968	0,25	10	50	1.500
16,00€				

Multivolt 12-80 VDC - 97 dB
 Rezistent la diferite condiții meteorologice.
 Posibilitate de spălare cu apă sub presiune
 Protejat împotriva polarității inverse
 Sigilate cu rășini epoxidice
 Temperaturi suportate : de -30 la 70 °C



51967



51968

BARĂ EXTENSIBILĂ PENTRU GIROFAR

52843	1,03	20	1.500
32,40€			

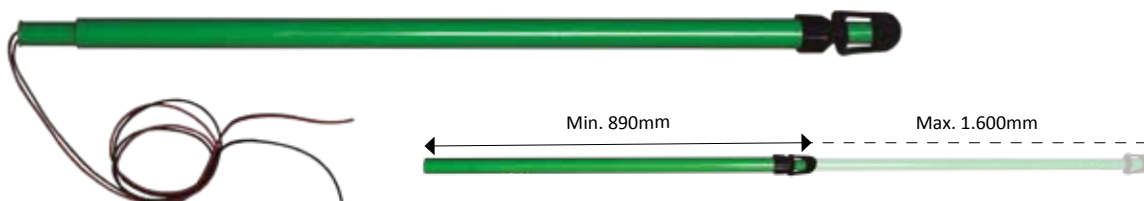

CONECTOR PENTRU GIROFAR

PENTRU REF. 51964, 51965,
52300, 52456, 52549

10750	
13,00€	
	0,25
	50



PENTRU REF. 51964, 51965,
52300, 52456, 52549

10751	
15,00€	
	0,33
	50



BEC DE SCHIMB

PENTRU REF. 51966

11103	
5,00€	
	0,01
	1



PENTRU REF. 51960, 51962, 51964

10766	
2,80€	
	0,02
	200



TULIPĂ PORTOCALIE DE SCHIMB PENTRU REF. 51960, 51962, 51964

Tulipă anti-rupture

51969	0,12	50
14,00€		
11324	0,13	50
17,50€		
11325	0,12	50
17,50€		



120mm
 Ø128mm



FAR CU LEDURI



53163	0,35	20	700
33,20€			

12V - 24V

INPUT: DC12-24V
 OUTPUT: DC5.8V 500mA

16 LED CREE	x9
IP 56	1,5H
120 Flash/min	4H



CE
 ECE R65

PROIECTOR PĂTRAT DE LUCRU CU LED

52302	0,84	5	20	480		140mm	117mm	45mm
28,00€								

52303	0,76	5	20	480		140mm	∅123mm	45mm
28,00€								

1.450 Lm		x9 LED 3W	ALU	10-30V 27W - +	IP 68	+30.000H
--------------------	--	---------------------	------------	----------------------	--------------	-----------------



PROIECTOR DE LUCRU CU LED PĂTRAT, LUMINĂ DIFUZĂ

52566	1,09	10	400		165mm	117mm	45mm
39,00€							

52567	1,02	10	400		170mm	∅127mm	45mm
39,00€							

1.450 Lm		x9 LED 3W	ALU	10-30V 27W - +	IP 68	+30.000H	
--------------------	--	---------------------	------------	----------------------	--------------	-----------------	--



75mm

PROIECTOR DE LUCRU CU LED PĂTRAT, LUMINĂ CONCENTRATĂ

52415	0,60	5	20	640		140mm	117mm	45mm
31,00€								

52414	0,78	5	20	480		140mm	∅127mm	45mm
31,00€								

1.450 Lm		x9 LED 3W	ALU	10-30V 27W - +	IP 68	+30.000H
--------------------	--	---------------------	------------	----------------------	--------------	-----------------



PROIECTOR DE LUCRU CU LED LUMINĂ CONCENTRATĂ

52568	1,17	10	400		165mm	117mm	45mm
43,00€							

52569	1,04	10	400		170mm	∅127mm	45mm
43,00€							

1.450 Lm		x9 LED 3W	ALU	10-30V 27W - +	IP 68	+30.000H	
--------------------	--	---------------------	------------	----------------------	--------------	-----------------	--



75mm

LUMINI DIFUZE

N

53428	0,52	5	20		140mm	117mm	45mm
12,80€							

53429	0,52	5	20		140mm	∅127mm	45mm
12,80€							

FAR DE LUCRU 16 LEDURI LUMINI DIFUZE

53045	1,00	12	468					
38,60€	Kg	ft	mm			155mm	127mm	55mm

2.880 Lm		x16 LED 3W	ALU	9-36V 48W	IP 68	+30.000H
--------------------	--	----------------------	------------	--------------	--------------	-----------------



FAR DE LUCRU LED LUMINI DIFUZE

53046	0,74	12	468					
34,00€	Kg	ft	mm			139mm	128mm	48,5mm

2.272 Lm		x16 LED 1,5W	ALU	9-36V 24W	IP 68	+30.000H
--------------------	--	------------------------	------------	--------------	--------------	-----------------



FAR DE LUCRU LED LUMINI DIFUZE

53052	2,75	6	468					
169,50€	Kg	ft	mm			191,5mm	Ø165mm	98mm

7.200 Lm		x8 LED 10W	ALU	9-36V 80W	IP 68	+30.000H
--------------------	--	----------------------	------------	--------------	--------------	-----------------



FAR DE LUCRU LED LUMINI DIFUZE

53049	1,53	10	468					
85,00€	Kg	ft	mm			118mm	123mm	87mm

3.600 Lm		x4 LED 10W	ALU	9-36V 40W	IP 68	+30.000H
--------------------	--	----------------------	------------	--------------	--------------	-----------------



PROIETTOARE PĂTRATE

FAR DE LUCRU LED LUMINĂ CONCENTRATĂ

53051	2,75	6	468		191,5mm	∅165mm	98mm
169,50€	Kg						

7.200 Lm		x8 LED 10W	ALU	9-36V 80W	IP 68	+30.000H
-----------------	--	-------------------	------------	-----------	--------------	-----------------



FAR DE LUCRU LED LUMINĂ CONCENTRATĂ

53047	5,51	4	32		230mm	185mm	150mm
265,50€	Kg						

3.200 Lm		x10 LED 5W	ALU	12-24V 50W	IP 67	+30.000H		280cm
-----------------	--	-------------------	------------	------------	--------------	-----------------	--	--------------

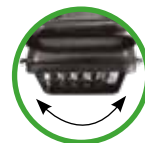

ROTATIV



DISTANȚĂ 100M



VITEZĂ REGLABILĂ DE MIȘCARE

FAR DE LUCRU LED LUMINĂ CONCENTRATĂ

53048	1,50	10	1.000		118mm	123mm	87mm
85,00€	Kg						

3.600 Lm		x4 LED 10W	ALU	9-36V 40W	IP 68	+30.000H
-----------------	--	-------------------	------------	-----------	--------------	-----------------



FAR DE LUCRU LED LUMINI DIFUZE

53050	1,53	10	468		118mm	123mm	87mm
85,00€	Kg						

3.600 Lm		x4 LED 10W	ALU	9-36V 40W	IP 68	+30.000H
-----------------	--	-------------------	------------	-----------	--------------	-----------------



BARĂ PENTRU REMORCĂ CU 2 CATAREFLECTANTES TRIUNGHILARE PILOȚII ȘI CABLU DE 5 M

HALÓGENO

50910	2,14	6	54	140mm	1100mm	Material: HDPE
39,00€	Kg					



LED

52838	1,96	1	6	54	140mm	1100mm	
53,50€	Kg						



Material: HDPE
Aprobat E4 7R-0218756

BARĂ TELESCOPICĂ DE SEMNALIZARE PENTRU REMORCĂ DE 1,4 LA 2,1M

52458	3,45	6	36	1,4m	2,1m
47,00€	Kg				



LED

52848	2,49	1	6	36	1,4m	2,1m	
75,60€	Kg						



Aprobat E4 7R-0218756

KIT MAGNETIC LĂMPI REMORCĂ

118mm	123mm	87mm	Cablu lung: 7m Cablu între lămpi: 2,5m
-------	-------	------	---

51886	1,47	8	96
42,00€	Kg		



LED

52839	1,47	8	200	
55,90€	Kg			



Aprobat E4-7R-0218756

LED PENTRU BARA DE TRACTARE

53151	0,20	5	20	1.040
12,50€	Kg			



TESTER LUMINI REMORCĂ 7 PINI

51929	0,20	5	26	1.144
25,00€	Kg			

Indică rapid dacă sunt probleme la cablurile atât ale mașinii cât și ale remorcii.

Poate fi utilizat la verificarea luminilor de la caravane și de la suporturi pentru biciclete.

PRIZĂ REMORCĂ PRIZĂ VEHICUL



CE

TESTER PRIZE REMORCI 13 PINI

52741	1,59	15	64	
218,00€	Kg			

Util pentru verificarea curentului de ieșire din autovehicul.

Potrivit pentru toate vehiculele de pe piață.

Cu simulare.

Cablu de 3,5m.



CE

MINI SET CU BECURI AUTO

0,09	10	100	1.500
Kg	Sub	11	

12 V H1



51613
2,40€

H4



52047
5,80€

51614
2,98€

H7



52048
5,38€

50431
2,98€

12V H7+H1



50915
3,80€

12 V HB3



50523
4,30€

12V HB4



50524
4,30€

12V H9



51615
5,80€

12V H11



51612
5,80€

PENTRU VEhicULE LAMPI

DULAP EXPOZITOR CU BECURI PENTRU AUTOTURISME

50551	9,39	2	12
250,00€	Kg	11	

Stop de 1 Pol

P21W 21 W BA15s 30u.
P21WA 21 W BA15s Ambar / 10u.
PY21W 21 W BAU15s
Con desc. / 10u.

Stop de 2 Polos

R21/5 W 21/5 W BAY15d 40u.
PLAFONIER
C5W 5 W SV8.5 11x38 22u.

Stop de 2 Poli

R5W 5 W BA15s 30u.
R10W 10 W BA15s 30u.

Lămpi indicatoare

T4W 4 W BA9s 22u.

Lămpi cu Halogen

H1 55 W P14.5s 10u.
H2 55 W X511 4u.
H3 55 W PK22s 4u.
H4 60/55 W P43t 10u.
H7 55 W PX26d 10u.
HB3 65 W P20d 4u.
HB4 55 W P20d 4u.
H9 65 W PGJ19-5 4u.
H11 65 W PGJ19-2 4u.

Focar European

T5 1,2 W W2.1x4,6d 20u.
T10 5 W W2.1x9,6d 12u.
T10 3 W W2.1x9,6d 12u.
T13 10 W W2.1x9,6d 10u.
T15 18 W W2.1x9,6d 10u.
T20 21 W W5x16d 10u.
T20A 21 W W5x16d Ambar 10u.
T20 21/5 W W5x16d 10u.

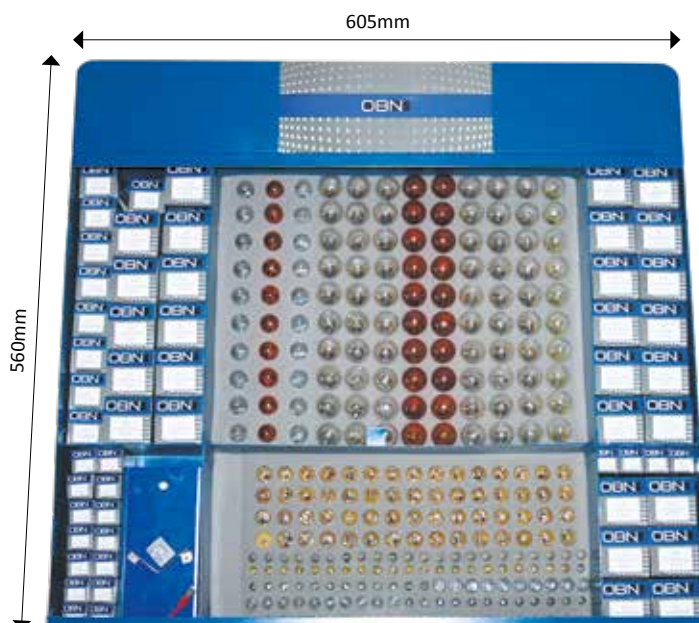

H7

52365	0,01	10	200	8.400
3,42€				

Volt: 12V, Wați: 55W,
Ambalaj: Cutie 1pcs

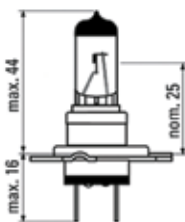

H4

52364	0,02	8	200	4.400
3,92€				

Volt: 12V, Wați: 60/55W,
Ambalaj: Cutie 1pcs

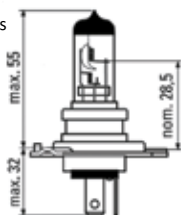

H1

52362	0,01	10	200	14.400
1,68€				

Volt: 12V, Wați: 55W,
Ambalaj: Cutie 1pcs

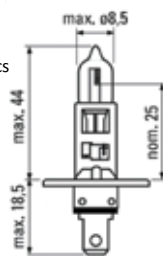

BA15S N

53203	0,10	10	1.000
0,36€			

V: 12V
W: 21W

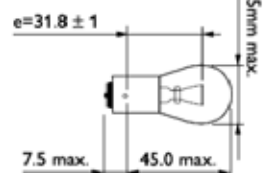

H1 35W

10766	0,02	200
2,80€		

Volt: 12V, Wați: 55W,
Ambalaj: Cutie 1pcs

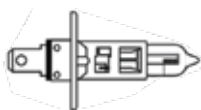

H3

52363	0,02	10	200
1,68€			

Volt: 12V, Wați: 55W,
Ambalaj: Cutie 1pcs

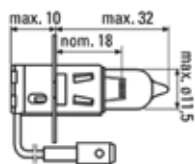

1 POLO

52366	0,10	10	200
0,57€			

Volt: 12V, Wați: 21W,
Ambalaj: Cutie 10pcs
Coajă BA15s

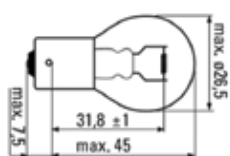

2 POLOS

52367	0,10	10	200
0,57€			

Volt: 12V, Wați: 21/5W,
Ambalaj: Cutie 10pcs
Coajă BAY15d

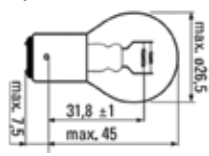

2 POLOS

52369	0,01	10	1.000
1,62€			

Volt: 12V, Wați: 21/55W,
Ambalaj: Cutie 10pcs.
Fără Coajă T20

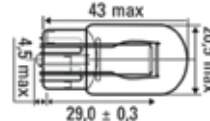

PLAFONIER

52371	0,01	10	2.000
0,36€			

Volt: 12V, Wați: 5W,
Ambalaj: Cutie 10pcs
Fără Coajă SV8,3 11x31

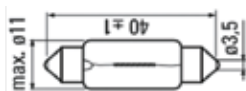

PLAFONIER

52410	0,01	10	2.000
0,36€			

Volt: 12V, Wați: 5W,
Ambalaj: Cutie 10pcs
Fără Coajă SV8,5 11x38

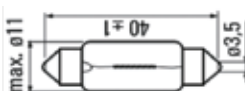

WEDGE T5

52859	0,01	10	5.000
0,45€			

Volt: 12V, Wați: 1,2W, T5
Ambalaj: Cutie 10pcs
W2x4,6d

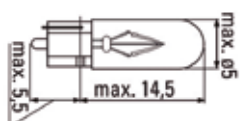

WEDGE T10

52860	0,01	10	5.000
0,36€			

Volt: 12V, Wați: 3W, T10
Ambalaj: Cutie 10pcs
W2,1x9,5d

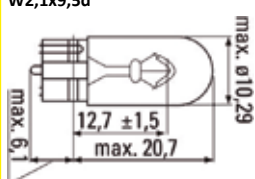

WEDGE T10

52861	0,01	10	5.000
0,36€			

Volt: 12V, Wați: 5W,
T10Ambalaj: Cutie 10pcs
W2,1x9,5d

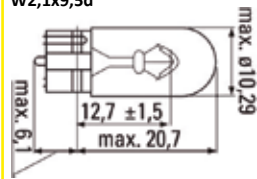

WEDGE T20

52862	0,01	10	1.000
1,80€			

Volt: 12V, Wați: 21W,
Ambalaj: Cutie 10pcs
W3x16d

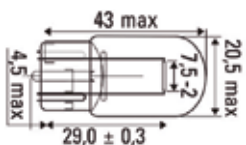

WEDGE T20

52863	0,01	10	1.000
1,80€			

Volt: 12V, Wați: 21W,
Ambalaj: Cutie 10pcs
WX3x16d

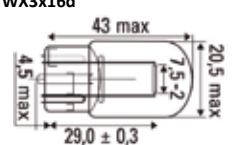

RSW

53007	0,01	10	200
0,40€			

Volt: 12V, Wați: 5W, T16
Ambalaj: Cutie 10pcs
Coajă BA15S

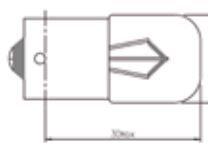

BAZ15D

52868	0,01	10	1.000
0,40€			

Volt: 12V, Wați: 21/4W,
Ambalaj: Cutie 10pcs
Coajă BAZ15D



BAU15S

52867	0,01	10	1.000
0,81€			

Volt: 12V, Wați: 21W, BAU15S
Ambalaj: Cutie 10pcs
Coajă BAU15s

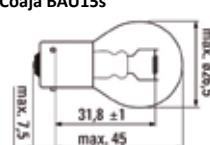

T20A

52368	0,01	10	1.000
1,56€			

Volt: 12V, Wați: 21W,
Ambalaj: Cutie 10pcs. Fără Coajă

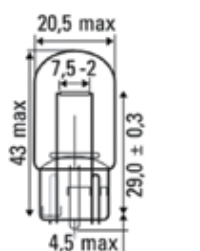

T20

52370	0,01	10	1.000
1,59€			

Volt: 12V, Wați: 21W,
Ambalaj: Cutie 10pcs. Fără Coajă

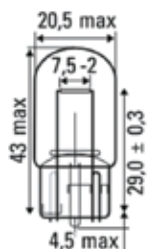

T20

52864	0,01	10	1.000
1,80€			

Volt: 12V, Wați: 21/5W,
Ambalaj: Cutie 10pcs
W3x16q

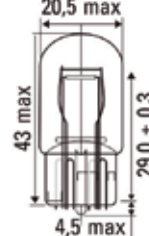

T13

52865	0,01	10	2.000
0,41€			

Volt: 12V, Wați: 10W, T13
Ambalaj: Cutie 10pcs
Fără Coajă

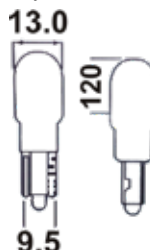

T15

52866	0,01	10	2.000
0,41€			

Volt: 12V, Wați: 18W, T15
Ambalaj: Cutie 10pcs
Coajă

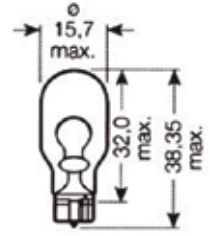

LANTERNĂ DE PLASTIC CU 9 LEDURI

REF.	0,03	12	144	3.456
2,60€	Kg	sub	fl	fl



În interpret
12 unități

52555



52557



52556



52558



LANTERNĂ CU 9 LEDURI

51325	0,04	12	144	3.024
2,70€	Kg	sub	fl	fl

Articol auxiliar
9 Leduri de lungă durată



În interpret
12 unități



LANTERNĂ CU 21 LEDURI

51326	0,07	12	144	2.880
5,30€	Kg	sub	fl	fl



Articol auxiliar
21 Leduri de lungă durată



În interpret
12 unități



LANTERNĂ CU DINAM ȘI 2 LEDURI

51573	0,07	12	96	3.456
2,00€	Kg	sub	fl	fl



PREZENTARE:
ÎN CUTIE INDIVIDUAL



LANTERNĂ CU DINAM ȘI 3 LEDURI

51446	0,08	12	96	3.456
2,60€	Kg	sub	fl	fl



În interpret
12 unități



BATERIE DE SCHIMB

R14P 1,5V	51331	0,09	240
	0,38€	Kg	fl
PENTRU REF. 51701			
	10924	0,05	12
	4,50€	Kg	fl
PENTRU REF. 50917			

"AAA" R03 1,5V	51258	0,02	60	1.200
	0,15€	Kg	sub	fl
PENTRU REF. 51325, 51326, 51829, 52233, 51001, 52582, 52555, 52556, 52557, 52558, 52584				

PĂTRAT DE STIVĂ 9V	10923	0,05	288
	1,10€	Kg	fl
PENTRU REF. 52162, 52450, 51929, 50942			



05

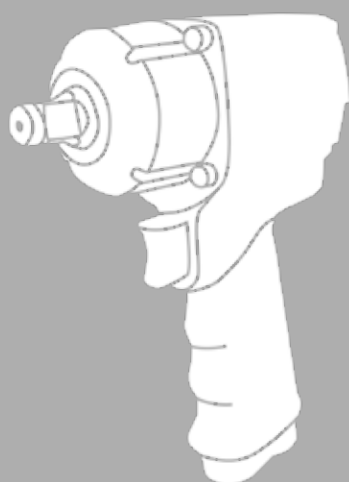

INSTRUMENTE PNEUMATICE

PISTOL DE IMPACT	88
PENTRU CAMIOANE	90
CLICHET	91
MAȘINĂ DE GĂURIT	92
POLIZOR	93
MAȘINĂ DE TĂIAT	95
MAȘINĂ DE ȘLEFUIT	96
PISTOL DE AER	98
FILTU	100
ADAPTOR / CUPLĂ	100
TAMBUR CU FURTUN RETRACTABIL	101

PISTOL DE IMPACT MODEL NANO 1/2" 1356Nm

52981	1,95	5	10	300
182,00€	Kg			

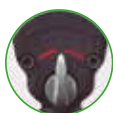

1/2"	1,8kg	120mm
145mm	9.000 RPM	1.356 Nm
0,2 m ² /min	2.8 (m ² /s ²)	94 dBa

PISTOL DE IMPACT DE 1/2" MODEL NANO (1070NM)



53460	-	5	10
198,00€	Kg		



1/2"	8.500 RPM
113mm	1/4"
750-1070 Nm	85 dBa

SET PISTOL IMPACT COMPOSITE + TUBULARE 542Nm

51207	3,95	5	80
260,00€	Kg		

COMPOSITE



1/2"	4.000 RPM	8.000 RPM	68-542 Nm
	83 dBa		

17, 19, 21mm

PISTOL DE IMPACT DE 1/2" MODEL NANO 678Nm

52790	1,51	5	10	300
168,00€	Kg			



1/2"	10.000 RPM	500-678 Nm	1/4"
2.8 (m ² /s ²)	94 dBa	90mm	



PISTOL DE IMPACT 1/2" DUBLU BLISTER COMPOSITE

51222	1,09	20	240
112,00€	Kg		

COMPOSITE



1/2"		360°	1/4"	6.3 bar
10.000 RPM	122 Nm	85 L/m		

PISTOL MINI DE IMPACT 1/2" COMPOSITE 338Nm

51206	1,46	10	150
230,00€	Kg		

COMPOSITE



1/2"	11.000 RPM	11.000 RPM	
338Nm	600Nm	83 dBa	624 Nm

PISTOL DE IMPACT DE 1/2" COMPOSITE 542 Nm

52984	1,41	10	180
99,00€	Kg		

COMPOSITE



1/2"	1,2kg	10.000 RPM	6,5 CFM	6.3 bar	542 Nm
	1/4"				

PISTOL DE IMPACT 1/2" COMPOSITE 1220Nm

52983	1,44	10	400
148,00€	Kg	ft	

COMPOSITE



1/2"	1,2kg	9.000 RPM
1.220 Nm	6 CFM	6.3 bar
130mm	1/4"	x4 SPEED

PISTOL DE IMPACT DE 1/2" COMPOSITE 1492Nm

52767	2,66	10	160
328,00€	Kg	ft	

COMPOSITE



1/2"	5.000 RPM	1.492 Nm	4,90 CFM	x3 SPEED
90 PSI 6,3 bar	100 PSI 7,0 bar			

PISTOL DE IMPACT 3/4" COMPOSITE 1627Nm

51212	3,77	4	60
520,00€	Kg	ft	

COMPOSITE



3/4"	5.500 RPM 1.627 Nm	5.500 RPM 1.600 Nm	90 dBa
------	--------------------	--------------------	--------

PISTOL DE IMPACT 3/4" COMPOSITE



53142	2,29	10
285,85€	Kg	ft

COMPOSITE



3/4"	190mm	90 PSI 7 CFM	1.626 Nm
6.700 RPM	3/8"	x3 SPEED	

PISTOL DE IMPACT DE 3/4"



53343	7,90	2
251,70€	Kg	ft



3/4"	4.600 RPM	1.600 Nm 1.180 FT-LB	245mm	33mm 1-1/3" in
9 CFM 254 L/m	x6 SPEED	90 psi		

PISTOL DE IMPACT DE 1"



53344	8,05	2
290,75€	Kg	ft



1"	4.600 RPM	1.600 Nm 1.180 FT-LB	245mm	33mm 1-1/3" in
90 PSI 9 CFM	x6 SPEED	9 CFM 254 L/m		

PISTOL IMPACT DE 3/4"

+ PRELUNGITOR 15cm COMPOSITE 1627Nm

51210	4,49	4	60
647,00€	Kg	ff	ff

COMPOSITE



3/4"



PISTOL IMPACT DE 1"

+ PRELUNGITOR 12cm COMPOSITE 1627Nm

51213	4,77	4	60
658,00€	Kg	ff	ff

COMPOSITE



1"

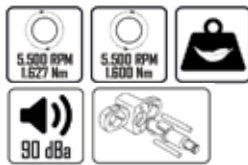

PISTOL DE IMPACT 1" COMPOSITE 1627Nm

51211	3,86	4	60
574,00€	Kg	ff	ff

COMPOSITE



1"



PISTOL DE IMPACT PENTRU CAMIOANE

N

53135	7,92	2	70
468,00€	Kg	ff	ff



485mm



PISTOL PNEUMATIC PENTRU ROȚI DE CAMION 3260Nm

52814	23,50	1	20
448,00€	Kg	ff	ff

32, 33mm

Leșire a aerului lateral
Reglare ușoară a vitezei de strângere.



670mm



220mm

1"



EXPOZANT UNEALTĂ PNEUMATICĂ

53147

27,20€

Kg 0,43

5

10

200



Livrat fără dispozitivul

CLICHET MINI DE 1/4" COMPOSITE

51214

145,00€

0,52 Kg

20

240

1/4" COMPOSITE

350 RPM 40,7 Nm 90 PSI 4 CFM 360°

85 dBa 1/4"



CLICHET PNEUMATIC DE 1/2"

52167

37,50€

1,27 Kg

10

640

1/2"

150 RPM 61 Nm 90 PSI 4 CFM

1/4"



TRUSĂ DE PIESE PNEUMATICE CU PISTOL DE IMPACT ȘI CLICHET

52156

109,30€

5,36 Kg

4

112

1/2"

16 PCS

COMPOSITE

9, 10, 11, 13, 14, 17, 19, 22, 24, 27mm

Pistol de Impact:

7.000 RPM 312 Nm 90 PSI 4 CFM

1/4"

Clichet Pneumatic:
Adaptor M / H

150 RPM 61 Nm 90 PSI 4 CFM

1/4"



CLICHET PNEUMATIC DE 1/2" COMPOSITE

51215

122,30€

1,33 Kg

20

240

1/2"

COMPOSITE

150 RPM 68 Nm 90 PSI 4 CFM 6.2 bar

79 dBa 1/4"



KIT CLICHET MULTIFUNCȚIONAL CU CAP DESCHIS COMPOSITE

51225

189,90€

0,89 Kg

10

120

1/4"

COMPOSITE

Kit include:

Adaptor de 1/4" la 3/8"

Capete pentru șurubelnițe de 1/4"

Set 2 șurubelnițe late + 2 șurubelnițe cruce.

850 RPM 360°

85 dBa 1/4"

1/4"



SET DE INSTRUMENTE PNEUMATICE

PISTOL DE IMPACT + CIOCAN PNEUMATIC + CLICHET PNEUMATIC + MINI SLEFUITOARE PNEUMATICĂ + PISTOL DE SUFLAT + PISTOL DE SUFLAT DREPT + ACCESORII

52331	7,79	2	48
183,50€			

1 x Pistol impact 1/2"
1 x Ciocan pneumatic 150mm
1 x Clichet pneumatic 3/8"
1 x Șlefuitoare pneumatică
1 x Arc de blocare
1 x Prolungitor 1/2" - 75mm
1 x Recipient mini pentru ulei
1 x Cheie hex. 4mm
8 x Tubulare impact: 12, 13, 17, 19, 1/2", 9/16", 5/8", 11/16"
1 x Pistol de suflat

1 x Mini pistol de suflat
1 x Bandă de teflon
4 x Dălți de 120mm
2 x Chei fixe manuale
5 x Disc de șlefuit 1/4"
5 x Disc de șlefuit 1/2"
5 x Freze de 1/4"
5 x Freze de 3/8"
2 x Cilindri de șlefuit (3/4" și 1")
1 x Adaptor rapid
1 x Conector abrupt

8 x Pini suflare
2 x Coliere 1/8"
1 x Conector M-M conexiune rapidă
1 x Conector rapid M-H
1 x Conector din cauciuc
1 x Conector conic
1 x Arc de umflare
1 x Conector de mare presiune
1 x Conector de siguranță
1 x Cutie de plastic



PISTOL DE IMPACT DE 1/2" 680Nm

52165	2,90	6	180
84,00€			



1/2"



PISTOL DE ÎNȘURUBAT CU IMPACT 102Nm

52168	1,02	10	400
36,00€			

Evacuare: lateral

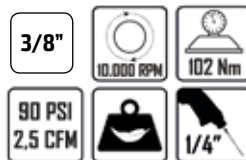

SET CIOCAN PNEUMATIC CU 9 PIESE

52718	2,11	8	160
34,00€			

9 PCS



MAȘINĂ DE GĂURIT PNEUMATICĂ REVERSIBILĂ DE 1/2"

52159	1,79	5	10	240
48,00€				

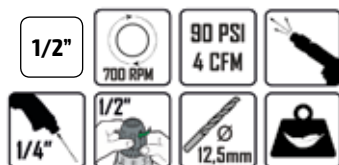

MAȘINĂ DE GĂURIT PNEUMATICĂ REVERSIBILĂ DE 3/8" ÎN UNGHI DE 90°

52527	1,22	5	10	480
59,50€				

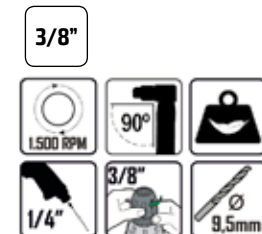

MAȘINĂ DE GĂURIT PNEUMATICĂ REVERSIBILĂ DE 3/8"

52160	1,22	5	10	400
38,00€	Kg			



MAȘINĂ DE GĂURIT PNEUMATICĂ LA 90° COMPOSITE

51221	1,27	10	120
181,90€	Kg		

COMPOSITE

Reversibilă pe amandouă părți
Terminat din cauciuc



MAȘINĂ DE GĂURIT PNEUMATICĂ REVERSIBILĂ COMPOSITE

51220	1,64	10	120
195,00€	Kg		

COMPOSITE

Reversibilă pe amandouă părți

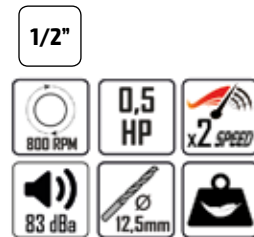

INSTRUMENT PNEUMATIC PENTRU SUPAPE DE ȘLEFUIRE

52689	1,75	10	320
144,50€	Kg		

20, 30, 35, 45mm

Regulator de viteză reglabilă

SUPAPE
DIN CAUCIUC



MINI POLIZOR ELECTRIC 1/4"



53137	0,55	48
38,10€	Kg	

COMPOSITE

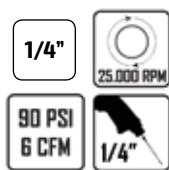

MAȘINĂ DE GĂURIT PNEUMATICĂ 1/4"



53141	0,6	60
60,30€	Kg	

COMPOSITE

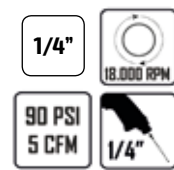

POLIZOR UNGHIULAR COMPOSITE

51218	2,27	10	120
238,00€	Kg		

1/4"

Terminat din cauciuc
Prindere mare
Pârghie reversibilă



COMPOSITE

PIESE DE SCHIMB ÎN PAG. 96

MINI POLIZOR 6mm COMPOSITE

51245	0,60	20	240
95,80€	Kg		

1/4"

COMPOSITE



FERĂSTRĂU PNEUMATIC

52574	0,74	20	640
58,00€	Kg		

2 ferăstraie de schimb 95mm
2 chei allen
1 protector de ferăstrău



235mm



11956 4,10€
5 PÂNZE FERĂSTRĂU
CU 24 DINȚI PT. LEMN



11957 4,10€
5 PÂNZE FERĂSTRĂU
CU 32 DINȚI PT. FIER

MINI POLIZOR PNEUMATIC

52171	0,42	10	20	1.080
26,00€	Kg			

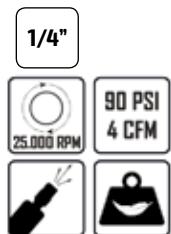

TRUSĂ DE 16 PIESE CU POLIZOR DREPT PNEUMATIC

52157	1	10	240
34,00€	Kg		

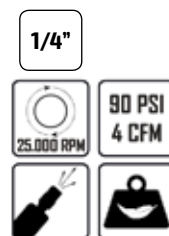

POLIZOR / BIAX PNEUMATIC UNGHILAR

52528	0,69	20	960
44,00€	Kg		

Corp fabricat din aluminiu acoperit cu cauciuc ergonomic
Manevrare și greutate ușoare



ÎNTRERUPTOR DE SIGURANȚĂ
INCORPORAT.

FLEX PNEUMATIC PROFESIONAL CU DISC

52166	2,04	5	10	200
63,50€	Kg			

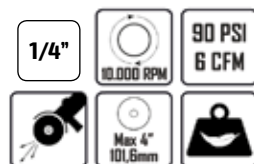

DISCO PENTRU ȘLEFUIT 4"
PENTRU 52166

12962 2,50€



FREZĂ PNEUMATICĂ PENTRU SUDURĂ CU DESPLASARE BIȚI CENTRA

52724	52725
292,00€	280,30€
Kg 2,55	Kg 2,35
6	10
84	180



52724

1.800 Rpm
Vârf de 8-6,5mm
De 1/4" / 6.3, 90(psi)



52725

1.600 Rpm
Vârf de 6.5 - 8.0 - 10mm
De 1/4" / 6.3 (psi)



BURGHIE
REF. 52725 Y 52724

13817 14,05€	6,5mm
13818 16,90€	8mm

FLEX PNEUMATIC REVERSIBIL COMPOSITE

51227	2,03	10	120
169,20€	Kg		

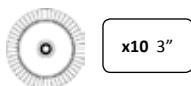

COMPOSITE

Terminat din cauciuc
Prindere mare
Mâner reversibil
Model MINI
Include Ochelari, Pârghie, Cheie Allen
și 10 discuri de 3"



PIESE DE SCHIMB ÎN PAG. 95

MAȘINĂ DE ȘLEFUIT PNEUMATICĂ DE 2" COMPOSITE

51226	1,52	10	120
195,00€	Kg		



COMPOSITE

Terminat din cauciuc
Prindere mare
Mâner rezistent
Model MINI
Include: ochelari, pârghii și discuri
de #60, #80 și #120



PIESE DE SCHIMB ÎN PAG. 96

POLIZOR UNGHIULAR DE 4" CU EXTENSIE COMPOSITE

51219	2,10	10	120
195,00€	Kg		

Terminat din cauciuc
Prindere mare
Prelungitor de 10 cm
Mâner rezistent în 8 poziții

3/8" COMPOSITE



TĂIETOR PNEUMATIC DE 3"

52953	0,90	20	1.500
26,00€	Kg		

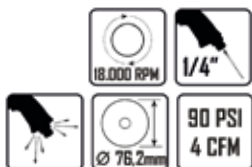

BLADE OARA TĂIETOR
PNEUMATICE DE 3"
(REF. 52953)

12987	1,20€
--------------	--------------

MAȘINĂ DE TĂIAT PNEUMATICĂ



53140	0,99	14
84,95€	Kg	

COMPOSITE



DISC DE SCHIMB
PENTRU REF. 53140

14013	0,60€
--------------	--------------

DISCURI DE TĂIAT

PENTRU REF. 51227

51387	0,02	100	800
2,50€	Kg		

3"



Ø Interior:
9,53mm
Ø Exterior:
75mm

PENTRU REF. 51219

51385	0,07	25	800
3,80€	Kg		

#60



Ø Interior:
9,53mm
Ø Exterior:
100mm

MAȘINĂ DE ȘLEFUIT

N

53136	1,13	9	152
151,55€	Kg	ff	ff



DISCURI DE ȘLEFUIRE

PENTRU REF. 51218

51386	0,10	25	800
5,40€	Kg	ff	ff



PENTRU REF. 51226

51443	0,02	25	800
5,00€	Kg	ff	ff



PENTRU REF. 51226

51444	0,02	25	800
5,00€	Kg	ff	ff



PENTRU REF. 51226

51445	0,02	25	800
5,00€	Kg	ff	ff



MAȘINĂ DE ȘLEFUIT ORBITAL AUTO-ASPIRARE COMPOSITE

52676	1,50	5	10	120
76,70€	Kg	sub	ff	ff

← 214mm →



ERGONOMIC

Corp din aluminiu cu mâner din cauciuc
Excelent randament de curățare cu pungă și furtun

MAȘINĂ DE ȘLEFUIT ORBITAL ADAPTABILĂ LA ASPIRATOR COMPOSITE

52675	1,27	5	10	160
69,20€	Kg	sub	ff	ff

← 200mm →



Corp din aluminiu

DISC CU 6 ORIFICII MAȘINI DE ȘLEFUIT
Ø 150mm

12009 7,50€

DISC CU 15 ORIFICII MAȘINI DE ȘLEFUIT
Filet 5/16" Ø 147mm

13499 7,70€

DISC DE 66 ORIFICII PENTRU MAȘINI DE ȘLEFUIT
Filet 5/16" Ø 149mm

13500 7,70€

MAȘINĂ DE ȘLEFUIT ORBITAL 150mm CU FURTUN ȘI PUNGĂ PENTRU PRAF

52376	2,05	6	54
258,00€	Kg	ff	ff

104mm
187mm

COMPOSITE

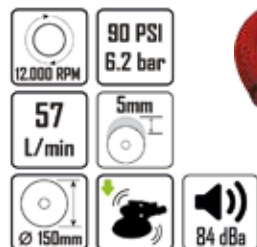

CLEȘTE AUTOBLOCANT CU CIOC GHEARĂ DINȚAT

52378	0,36	10	40	720
8,00€	Kg	sub	ff	ff

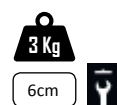

51341	1	12	144
29,80€	Kg	ff	ff



DISPOZITIV PNEUMATIC FIXARE BURDUF PLANETARĂ

51861	4,08	2	32
148,00€			



Material: Aluminiu
Deschidere de 20 la 100mm



VENTUZĂ PNEUMATICĂ PENTRU ÎNDREPTAT LOVITURI LA CAROSERII AUTO

52540	4,69	3	72	620mm	160L / min
159,70€				Ø 75 - 100 - 125mm	70-110Psi



Ventuză cu glisor pneumatic pentru înlăturarea urmelor de lovituri.
Desenul sau permite eliminarea urmelor de lovituri de o maniera rapida si facila.

MAȘINĂ PNEUMATICĂ UNIVERSALĂ COMPOSITE

51216	4,33	4	16
520,00€			

COMPOSITE

Protecția persoanei care folosește mașina de resturi / scântei
Adaptor (patentat). Mâner anatomic
Seguritate în Acceleratorul de pârghie
Evacuare spate
Cheie Allen
Nivel de zgomot redus 83 dB (A)
Include: Diferite Tipuri de Perii
11 mm Perie de sârmă (fină) / 23 mm Perie de Sârmă (fină)

11 mm Perie de sârmă (groasă) / 23 mm Perie de sârmă (groasă)
Gumă de șters
Gumă de șters vopsea pe bază de apă
Adaptor de 23 mm pentru gumă de șters
Adaptor de 11 mm perie de sârmă
Șlefuitor Cauciuc Negru (până la 6 piese)
Adaptor unic de Șlefuitor cauciuc
Adaptor de bandă din cauciuc dublu

MÂNER
ERGONOMIC



ACCESORII

ADAPTOARE

25,00€/u.		
0,10	1	800



51439
Pentru roată de 23 mm



51440
Pentru roată de 11mm



51441
Roată neagră dublă



51442
Roată neagră simplă

PERII

18,00€/u.		
0,10	1	800



51388
Unghi de 23mm



51389
Unghi de 11mm



51390
Fină lată de 23mm



51391
Fină lată de 11mm

ROȚI RĂZUITOARE

25,00€/u.		
0,10	1	800



51392
Perie - roată răzuitoare de vopsea
Ø105mm



51393
Perie răzuitoare de vopsea de apă
Ø105mm

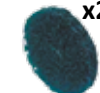

51394
Roată neagră



POMPĂ DE AER

N

ANALOGIC

53449	0,5	5	20
15,95€	Kg	5x6	11

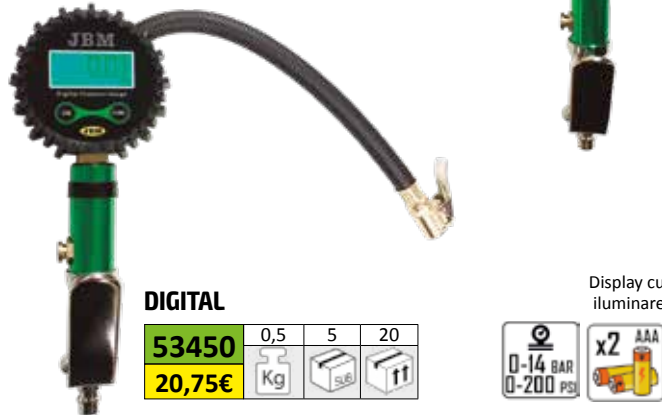

DIGITAL

53450	0,5	5	20
20,75€	Kg	5x6	11



Display cu iluminare

PISTOL PENTRU CURĂȚAREA FILTELOR DE PARTICULE

52543	0,84	6	96
128,70€	Kg	11	11



Universal
Capacitate maximă: 650cc
Furtun de nailon de 4x6x2.7m
Rang de presiune de lucru: 3 bar - 7 bar
Corp inoxidabil de lungă durată
+ Bază de aluminiu

LICHID DESCARBONIZARE

90003	1,08	3	12	400
35,20€	Kg	5x6	11	11

LICHID NEUTRALIZARE

90004	0,50	3	24	320
25,80€	Kg	5x6	11	11

SERIE75: SET COMPUS DIN 52543+90003+90004 **183,00€**

PISTOL DE AER + PISTOL PENTRU UMFLAT PNEURI

51981	0,58
18,00€	

Kg	0,58
5x6	10
11	20
11	240



PISTOL DE AER COMPRIMAT CU MANOMETRU

51980	0,38	5	25	300
12,40€	Kg	5x6	11	11



VERIFICATOR DE PRESIUNE A PNEURILOR

N

52648	0,10	5	100
6,00€	Kg	5x6	11



CU TUB

53416	0,20	10	100
11,60€	Kg	5x6	11



DIGITAL CU TUB

53417	0,30	10	100
19,20€	Kg	5x6	11

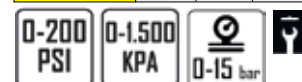

DIGITAL

53418	0,20	10	100
10,15€	Kg	5x6	11

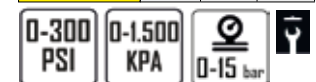

PISTOL DE AER

52490	0,12	10	40	960
4,70€	Kg	sub	ft	

100mm

52491	0,10	10	80	400
7,70€	Kg	sub	ft	

300mm



În interpret
10 unități

PISTOL DE AER EXTENSIBIL

52798	0,25	10	50	700
12,80€	Kg	sub	ft	



285-530mm



IMBUS ACOPERIT DE GUMĂ PENTRU A EVITA ZGÂRIETURI.

POMPĂ DE SUFLARE CU MARE CAPACITATE N

53205				
14,65€	Kg	ft		
	0,90	60		
		500		



Pompă debit mare.
Material corp: aliaj de aluminiu.
Suprafață: placat cu nichel.



MARE CAPACITATE

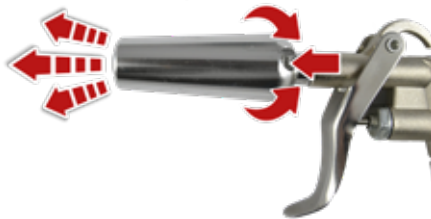

TRUSĂ AEROGRAF

52529	0,43	5	20	480
26,00€	Kg	sub	ft	

Pistol cu regulator de presiune și ieșire de vopsea
2 depozite de 15ml.
Furtun pneumatic 160mm
Adaptor furtun
Conector de 1/4"



SET DE 5 PISTOALE DE AER

51277				
39,00€	Kg		1,84	
	ft		10	
			80	



Pistol pentru vopsit prin gravitație la rezervor de 600 ml.
Pistol pentru umflat pneuri, cu aparat pentru măsurarea presiunii
Pistol pentru suflat aer

Pistol pentru curățat cu ajutorul lichidelor
Furtun - spirală de 5x8 mm cu conexiune rapidă 1/4" extensibil până la 4,5m
extensibil până la 4,5m

PISTOL DE SUFLAT CU AER

51383	0,27	10	50	700
8,60€	Kg	sub	ft	

Pistol de suflat
Reducție pentru conector rapid
Reducție pentru furtun
Teavă de 10 cm
Teavă de 20 cm



În interpret
10 unități

PISTOL DE AER EXTENSIBIL ÎN AMBALAJ INDIVIDUAL

52787				
6,20€	Kg		0,20	
	sub		25	
	ft		100	
			1.000	



PISTOL DE SUFLAT DE 3/8" CU FURTUN DE 5M

52381				
15,60€	Kg		0,45	
	sub		5	
	ft		25	
			200	



Material:
PU // 35 rotații

SERINGĂ DE ULEI

N

53202	1,40	10	120
15,65€	Kg	ff	ff



Pistol de curățare a motorului.
Pot Material: Oțel.
Material corp: aliaj de aluminiu.
Suprafață: Pulbere de acoperire.



POMPĂ DE CURĂȚARE

N

53204	0,90	10	60
56,30€	Kg	ff	ff



Masini de curățare arma, Tornado.
Pot Material: PE.
Material corp: aliaj de aluminiu.
suprafață corporală: lustruită.

FILTRU ȘI REGULATOR DE AER

53063	0,63	5	50
29,00€	Kg	sub	ff

1/4"

53064	0,63	5	50
29,00€	Kg	sub	ff

3/8"

53065	0,63	5	50
29,00€	Kg	sub	ff

1/2"



FILTRU, REGULATOR DE AER ȘI ULEI

53066	1,08	5	25	50
48,00€	Kg	sub	ff	ff

1/4"

53067	1,07	5	25	50
48,00€	Kg	sub	ff	ff

3/8"

53068	1,06	5	25	250
48,00€	Kg	sub	ff	ff

1/2"



ADAPTOR ARTICULAT PNEUMATIC

N

		Kg	ff	ff	€
12988	1/2"	0,15	62	125	7,00€
13809	1/4"	0,10	62	250	8,75€
13810	3/8"	0,10	62	250	10,30€



CUPLĂ PNEUMATICĂ RAPIDĂ

52735	M6
4,50€	
0,07	25
Kg	ff



52736	M8
4,50€	
0,07	25
Kg	ff



52737	M10
4,50€	
0,08	25
Kg	ff



CONECTOR / CUPLAJ

N

REF.	DESCRIERE	Ud.	€
13930	CONECTOR FILET EXTERIOR 1/4" US	1	0,95€
13931	CONECTOR FILET EXTERIOR 1/4" EURO	2	1,70€
13932	CONECTOR FILET EXTERIOR 3/8" US	1	1,10€
13933	CONECTOR FILET EXTERIOR 1/2" US	1	1,30€
13934	CONECTOR FILET INTERIOR 1/4" EURO	2	1,40€
13935	CONECTOR FILET INTERIOR 1/4" US	2	1,40€
13936	CUPLAJ CU FILET INTERIOR 1/4" US	1	3,10€
13937	CUPLAJ CU FILET EXTERIOR 1/4" US	1	3,20€
13938	CUPLAJ CU FILET INTERIOR 1/4" EURO	1	3,10€
13939	CUPLAJ CU FILET EXTERIOR 1/4" EURO	1	3,20€



TAMBUR CU FURTUN RETRACTABIL 12M CAPĂT DE 3/8"

REF.	7,10	1	21
98,00€	Kg		

Suport/tambur pentru aer
Fără electricitate
Fără baterie
PVC
Cu repartiție, auto încolăcire

12m	3/8"
Ø9,5mm	300 PSI 20 BAR



51299

52755

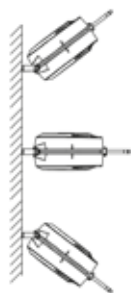

Furtun: Ø interior = 9,5mm / Ø exterior = 12 mm
Filet: Ø exterior = 14 mm

TAMBUR VERDE CU FURTUN RETRACTABIL 20M

REF.	9,05	1	16
134,00€	Kg		

Suport/tambur pentru aer
Fără electricitate
Fără baterie
PVC
Cu repartiție, auto încolăcire

20m	Ø9,5mm
3/8"	300psi 20bar



53115

N

53213

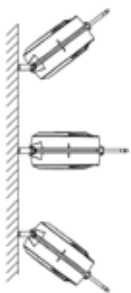



06



UTILE DE IMPACT

SET DE TUBULARE	103
SET DE IMBUSURI	105
PRELUNGITORI	106
TUBULARĂ IMPACT	107
UTILE VEICULE GRELE	109

SET DE 6 TUBULARE IMPACT DE 1/2" HEX.

52337	1,91	10	300
47,50€	Kg		

1/2"

30, 32, 36mm
(78mmL)

3 capete hexagonale
de 14, 17 și 19



SET DE 8 TUBULARE ȘI CAPETE XZN 1/2" DE IMPACT

52547	2,76	5	200
69,00€	Kg		

1/2"

27, 30, 32,
34, 36

M14, M16,
M18 (44mmL)



SET 13 PIESE, TUBULARE DE IMPACT DE 1/2" HEX. + ADAPTOR

52341	1,72	12	336
42,00€	Kg		

1/2"

10, 11, 12, 13, 14,
17, 19, 21, 22, 24mm
(38mmL)

1 articulație universal
1 prelungitor de 125mm
1 adaptor de imbusuri de 1/4"



SET DE 19 PIESE DE IMPACT DE 1/2" CU 14 TUBULARE HEX. + ADAPTOARE

52345	3,55	6	234
78,20€	Kg		

1/2"

10, 11, 12, 13, 14, 15,
16, 17, 18, 19, 21, 22,
24, 27mm

3 Prolungitoare 50, 150
și 250mm
1 Adaptor 1/2" H X
3/4" M
1 Articulație universal
1/2"



SET DE 15 PIESE DE IMPACT CU 12 TUBULARE LUNGI DE 1/2" HEX. + ADAPTOARE

52346	4,55	6	216
78,20€	Kg		

➤ **PIESE DISPONIBILE
CONSULTAȚI P.108 REF. 12061 - 12072**

1/2"

10, 12, 13, 15, 16,
17, 18, 19, 21, 22,
24mm, 27mm
(78mmL)

1 articulație universal
2 prelungitoare: 125 și 250mm



SET 11 TUBULARE DE IMPACT HEX. DE 1/2"

52342	2,41	10	360
47,90€	Kg		

➤ **PIESE DISPONIBILE
CONSULTAȚI P.108 REF. 12061 - 12072**

1/2"

10, 11, 12, 13,
14, 16, 17,
19, 21, 22,
24mm
(78mmL)



SET 12 TUBULARE IMPACT 1/2" PROFIL REDUS

53060	0,86	5	20	500
27,40€	Kg			

1/2" 28.2mm

10, 11, 12, 13, 14, 15, 16, 17,
18, 19, 20, 21mm



SET 4 TUBULARE IMPACT DE 1/2" SP. EXTRACȚIE ROȚI

52338	1,12	20	640
32,00€	Kg	ff	ff

1/2"



17, 19, 21mm
(85mmL)

11314 6,40€ Ø 17mm

11315 6,60€ Ø 19mm

11316 6,90€ Ø 21mm

11628 7,20€ Ø 22mm



SET 12 TUBULARE IMPACT 1/2" PROFIL REDUS

51336	0,82	5	20	640
26,00€	Kg	sub	ff	ff

1/2"



17, 19, 21mm
(85mmL)



SET 3 TUBULARE DE IMPACT HEX. LONG

52969	0,80	20	1.500
15,25€	Kg	ff	ff

1/2"



17, 19, 21mm
(78mmL)



REF.	DESCRIERE	Kg	ff	ff	€
12066	TUBULARĂ IMPACT HEX. LONG 1/2" 17MM	0,18	10	90	5,90€
12068	TUBULARĂ IMPACT HEX. LONG 1/2" 19MM	0,21	10	60	6,10€
12069	TUBULARĂ IMPACT HEX. LONG 1/2" 21MM	0,20	10	50	6,20€

SET DE 12 TUBULARE DE IMPACT DE 1/2" HEX. SPECIAL EXTRACȚIE ROȚI

52343	1,89	12	288
42,00€	Kg	ff	ff

1/2"



17, 19, 21mm
(85mmL)

10, 11, 13, 14, 17, 19,
22, 24mm (38mmL),
27mm (42mmL)



SET DE 3 TUBULARE XZN DE 1/2" DE IMPACT

52694	1,31	10	600
34,60€	Kg	ff	ff

1/2"



30, 32, 36mm
(80mmL)



TUBULARA DE IMPACT 17MM PENTRU MERCEDES BENZ

52800	0,24	10	100
12,00€	Kg	sub	ff

17mm

Tubular de impact special pentru șuruburi de roată la vehiculele Mercedes Benz.

Valabil pentru modelele:
Clase E - W211, W212 y W207
Clase S - W221 y W222 / Clase SLK - W172
Clase C y GLK - W204 / Clase ML - W164 y W166 /
Clase CL - W216



SET DE 3 ARTICULAȚII DE IMPACT CU DUBLĂ PŌZIȚIE (FIX/ARTICULAT)

53043	0,43	25	50	1.000
38,00€	Kg			

1/2" 3/8" 1/4"



SET DE 4 TUBULARE DE IMPACT PENTRU ȘURUBURI DE SIGURANȚĂ

53197	1,17	5	20	1/2"
37,00€	Kg			

17, 19, 21, 22mm (82mmL)



SET DE 6 ADAPTOARE

52544	2,89	4	200
78,00€	Kg		

1" 3/4" 1/2"

1/2": F x 1"M (50mmL), F x 3/4"M (48mmL)
3/4": F x 1"M (63mmL), F x 1/2"M (85mmL)
1": F x 3/4"M (69mmL), M x 1/2"M (70mmL)



SET DE 6 TUBULARE XZN DE 1/2" DE IMPACT

52546	0,81	30	720
28,90€	Kg		

1/2"

M14, M16, M18 (43mmL)

M14, M16, M18 (78mmL)



TUBULARĂ CAPĂT XZN

1/2"

INVIOLABILĂ M16

52810	0,25	100
9,20€	Kg	

Tubulară de impact de 75 mm în lung și pătrat de 1/2" pentru extragerea șurubului de golire cu pistol de impact în transmisia vehiculelor VAG, Porsche, Ford etc.



INVIOLABILĂ M18

52811	0,17	100	1.500
9,20€	Kg		

Pentru extragerea brațului de direcție în vehiculele din grupul VAG.



SET DE 13 CHEI TUBULARE DE IMPACT 1/2" HEX. ȘI TORX

52344	1,48	1	600	1/2"
148,00€	Kg			

5mm 10mm
6mm 15mm
8mm (45mmL)

T30, T40, T45, T50, T55, T60, T70, T80 (45mmL)



SET 8 IMBUSURI DE IMPACT HEX. LUNGI DE 1/2"

52339	0,80	20	1.500	1/2"		5, 6, 7, 8, 10, 12, 14, 17mm (78mmL)
48,00€						

REF.	DESCRIERE			€
14004	TUBULARĂ HEXAGONALĂ DE IMPACT DE 1/2" 5MM	0,10	10	7,50€
14005	CAPETE IMPACT HEX. 1/2" 6MM	0,10	10	7,50€
14006	TUBULARĂ HEXAGONALĂ DE IMPACT DE 1/2" 7MM	0,10	10	7,50€
14007	TUBULARĂ HEXAGONALĂ DE IMPACT DE 1/2" 8MM	0,20	10	7,50€
14008	TUBULARĂ HEXAGONALĂ DE IMPACT DE 1/2" 10MM	0,10	10	7,60€
14009	TUBULARĂ HEXAGONALĂ DE IMPACT DE 1/2" 12MM	0,10	10	7,60€
14010	TUBULARĂ HEXAGONALĂ DE IMPACT DE 1/2" 14MM	0,10	10	7,90€
14011	TUBULARĂ HEXAGONALĂ DE IMPACT DE 1/2" 17MM	0,20	10	8,20€



SET 8 IMBUSURI DE IMPACT TORX LUNGI DE 1/2"

52340	1,16	10	292	1/2"		T25, T30, T40, T45, T50, T55, T60, T70 x (78mmL)
48,00€						

REF.	DESCRIERE			€
12939	VÂRF TORX DE IMPACT 1/2" T30	0,09	10	5,70€
12940	VÂRF TORX DE IMPACT 1/2" T40	0,09	10	5,70€
12941	VÂRF TORX DE IMPACT 1/2" T45	0,09	10	5,70€
12942	VÂRF TORX DE IMPACT 1/2" T50	0,09	10	5,70€
12943	VÂRF TORX DE IMPACT 1/2" T55	0,1	10	5,80€
12944	VÂRF TORX DE IMPACT 1/2" T60	0,12	10	6,00€
12945	VÂRF TORX DE IMPACT 1/2" T70	0,14	10	6,10€



SET DE PRELUNGITORI CU LIMITA DE CUPLU

53077	1,58	10	20	1.000	1/2"	CR-MO
56,00€						

100Nm
110Nm
120Nm
135Nm
150Nm



13680 12,00€
TIJE DE IMPACT
EXTENSION 200NM



13685 12,50€
TIJE DE IMPACT
EXTENSION 135NM



13681 12,00€
TIJE DE IMPACT
EXTENSION 190NM



13686 12,50€
TIJE DE IMPACT
EXTENSION 120NM



13682 12,00€
TIJE DE IMPACT
EXTENSION 175NM



13687 13,50€
TIJE DE IMPACT
EXTENSION 110NM

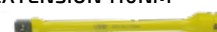

13683 12,00€
TIJE DE IMPACT
EXTENSION 160NM



13688 13,50€
TIJE DE IMPACT
EXTENSION 100NM

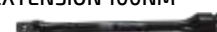

13684 12,50€
TIJE DE IMPACT
EXTENSION 150NM



13689 13,50€
TIJE DE IMPACT
EXTENSION 90NM

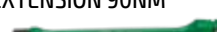

PRELUNGITOR ANTRENOR DE IMPACT

12937	0,11	10	100	1.500	1/2"
5,60€					



12937

12074	0,23	10	60	1/2"
6,60€				



12074

12075	0,43	10	40	1/2"
9,70€				



12075

ARTICULAȚIE UNIVERSALĂ DE IMPACT

11938	0,01	60				3/4"
42,00€	Kg					

11990	0,16	10				1/2"
15,00€	Kg					



11983



11990

JOC DE 2 ADAPTOARE DE IMPACT

52545	1,97	2	4			
178,00€	Kg					

1" 1/2" F - 1" M
1" F - 1" 1/2" M



ADAPTOR DE IMPACT

REF.	DESCRIERE				€
11962	1/2"H 3/4"M	0,16	10	60	6,00€
11963	1/2"H 1"M	0,26	6	36	7,00€
11964	3/4"H 1/2"M	0,34	6	36	9,00€
11965	3/4"H 1"M	0,44	3	36	12,00€
11966	1"H 1/2"M	0,53	6	24	14,00€
11967	1"H 3/4"M	0,53	6	18	14,00€



SET 8 TUBULARE DE IMPACT HEX. CU DUBLĂ POZIȚIE (FIX/ARTICULAT)

53044	2,43	8	1.000				1/2"
98,00€	Kg						

10, 12, 13, 15, 16, 17, 18, 19, 21, 22, 24mm, 27mm (78mmL)



SET DE 8 TUBULARE DE IMPACT HEX. 3/4"

52347	6,53	4	200				3/4"
118,00€	Kg						

26, 27, 29, 30, 32, 35, 36, 38mm (90mmL)



TRUSĂ DE 16 TUBULARE DE IMPACT

192,00€	6,26	3	380				3/4"
	Kg						

Adap. 1"
Adap. 3/4"
Allen 4 mm

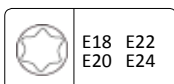
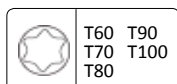
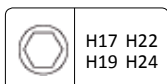

SET DE 8 TUBULARE DE IMPACT DE 1"

52348	6,08	2	252				1"
168,00€	Kg						

24, 27, 30, 32, 33, 36, 38, 41mm



TUBULARĂ IMPACT



		1"	
11153	36mm	0,71	14,00€
11154	37mm	0,73	14,70€
11155	38mm	0,74	15,00€
11156	39mm	0,74	16,90€
11157	40mm	0,78	17,00€
11158	41mm	0,81	17,50€
11159	42mm	0,91	18,60€
11160	43mm	0,94	18,70€
11161	44mm	0,93	19,00€
11162	45mm	0,94	19,30€
11163	46mm	1,00	19,50€
11164	47mm	1,02	20,40€
11165	48mm	1,01	20,50€
11166	50mm	1,18	22,20€
11167	51mm	1,18	25,60€
11168	52mm	1,18	26,00€
11169	53mm	1,27	26,50€
11170	54mm	1,33	27,00€
11171	55mm	1,44	30,30€
11172	56mm	1,47	31,80€
11173	57mm	1,44	32,00€
11174	58mm	1,58	32,30€
11175	59mm	1,58	33,00€
11176	60mm	1,62	34,80€
11177	62mm	1,63	37,30€
11178	63mm	1,75	37,80€
11179	65mm	1,87	41,40€
11180	67mm	1,93	44,50€
11181	68mm	1,93	44,80€
11182	70mm	2,09	48,00€
11183	71mm	3,10	50,00€
11184	73mm	3,27	60,00€
11185	75mm	3,34	62,00€
11186	76mm	3,70	63,00€
11187	78mm	3,47	68,30€
11188	80mm	3,69	69,50€
11189	85mm	3,81	79,50€
11190	89mm	3,80	96,50€
11191	90mm	4,29	96,80€
11192	92mm	4,50	106,00€
11193	95mm	4,89	114,00€
11194	100mm	4,36	123,30€
11621	105mm	7,81	222,00€

11622	110mm	7,75	280,00€
11623	115mm	8,21	303,00€

		1/2"	
11195	17mm	0,09	2,00€
11121	19mm	0,10	2,30€
11122	24mm	0,14	3,10€
11123	27mm	0,17	3,60€
11124	30mm	0,20	4,30€
11125	32mm	0,22	4,80€

		3/4"	
11126	19mm	0,25	6,80€
11127	21mm	0,29	7,60€
11128	22mm	0,34	8,10€
11129	24mm	0,32	8,20€
11130	25mm	0,33	8,20€
11131	26mm	0,32	8,30€
11132	27mm	0,35	8,30€
11133	28mm	0,40	8,80€
11134	30mm	0,41	9,20€
11135	32mm	0,44	9,70€
11136	33mm	0,47	9,80€
11137	34mm	0,51	11,00€
11138	35mm	0,49	11,20€
11139	36mm	0,52	11,30€
11140	38mm	0,53	11,80€
11141	40mm	0,54	12,70€
11142	41mm	0,61	13,00€
11143	46mm	0,74	15,60€
11144	50mm	1,00	20,00€
11145	51mm	1,10	21,20€
11146	55mm	1,23	23,60€
11147	57mm	1,23	26,80€
11148	60mm	1,40	28,30€
11149	63mm	1,32	31,80€
11150	65mm	1,50	33,80€
11151	67mm	1,49	40,30€
11152	70mm	1,49	44,00€

		1"	
11624	65mm	2,42	120,00€
11625	85mm	5,11	192,00€

		1/2" 78mmL	
11613	27mm	0,34	6,70€
11614	30mm	0,42	8,20€
11615	32mm	0,38	8,80€
11616	33mm	0,45	11,00€
11617	34mm	0,40	11,50€
11618	35mm	0,46	12,00€
11619	36mm	0,47	12,50€

		1/2" 78mmL	
12061	10mm	0,14	5,10€
12062	12mm	0,15	5,30€
12063	13mm	0,13	5,40€
12064	15mm	0,17	5,50€
12065	16mm	0,16	5,80€
12066	17mm	0,18	5,90€
12067	18mm	0,23	6,00€
12068	19mm	0,21	6,10€
12069	21mm	0,24	6,20€
12070	22mm	0,28	6,20€
12071	24mm	0,30	6,30€
12072	27mm	0,35	7,20€

		3/4" 90mmL		N
13723	19mm	0,41	10,50€	
13724	21mm	0,48	10,90€	
13725	22mm	0,61	11,00€	
13726	24mm	0,56	11,20€	
13727	26mm	0,51	11,40€	
13728	27mm	0,50	11,60€	
13729	29mm	0,71	12,60€	
13730	30mm	0,68	12,70€	
13731	32mm	0,71	12,90€	
13732	33mm	0,78	13,70€	
13733	34mm	0,81	14,40€	
13734	35mm	0,80	14,90€	
13735	36mm	0,81	15,00€	
13736	38mm	0,83	15,30€	

		1" 90mmL		N
13745	28mm	0,14	15,50€	
13746	30mm	0,15	15,70€	
13747	32mm	0,13	15,90€	
13748	33mm	0,17	16,30€	

UTILE VEHICULE GRELE

ORNAMENTE TUBULARĂ BPW

52914	3,16	1	4
178,50€	Kg		

Extragere buji ax din spate BPW.



120mm	8 FEȚ
PĂTRAT HEX 41mm	

TUBULARĂ PIULIȚĂ Pt. ROATĂ CAMION BPW

52915	2,94	1	8	1.500
161,00€	Kg			

Extragere buji ax din spate BPW.



111mm	OVAL
PĂTRAT HEX 41mm	

TUBLURARĂ PIULIȚĂ Pt. ROATĂ CAMION BPW

52916	2,57	1	1.000
153,70€	Kg		

Extragere buji ax din spate BPW.



109mm	8 FEȚ
PĂTRAT HEX 41mm	

TUBULARĂ AX DIN SPATE BPW

52917	1,11	1	1.000
98,50€	Kg		

Extragere buji ax din spate 6,5-9ton



65mm	OVAL
PĂTRAT 3/4"	

ORNAMENTE TUBULARĂ DIN SPATE

52918	2,05	1	1.500
118,10€	Kg		

Extragere ax din spate bpw



95mm	8 FEȚ
PĂTRAT 3/4"	

TUBULARĂ PIULIȚĂ PENTRU ROATĂ BPW

52919	2,80	1	8	1.500
146,80€	Kg			

Extragere ax din spate bpw



110mm	8 FEȚ
PĂTRAT 3/4"	

TUBULARĂ PENTRU EXTRAGEREA AUXULUI RULMENTULUI BPW

52920	1,35	1	10	1.000
114,10€	Kg			

Pentru extragerea piuliței anterioare rulmentilor in axe bpm 12 ton.



80mm	PĂTRAT 3/4"
------	-------------

TUBULARĂ PENTRU EXTRAGEREA PIULIȚEI AXULUI DIN SPATE BPW

52921	0,73	1	10
83,40€	Kg		

Pentru extragerea piuliței anterioare rulmentilor in axe bpw 6,5-9 ton.



65mm	PĂTRAT 3/4"
------	-------------

TUBULARĂ PENTRU EXTRAGEREA PIULIȚA PUNȚII SUNTVOR

52922	2,24	1	10	1.000
117,10€	Kg			

Pe axele BPW 16 TON



85mm	6 FEȚ
PĂTRAT 3/4"	

TUBULARĂ PENTRU EXTRAGEREA PIULIȚEI DE SUSPENSIE Pt. SCANIA

52923	0,45	1	12	1.500
36,30€	Kg			



28x37mm	PĂTRAT 3/4"
---------	-------------

TUBULARĂ PENTRU EXTRAGEREA PIULIȚEI DE SUSPENSIE Pt. SCANIA

52924	0,65	1	1.000
41,90€	Kg		



34x46mm	PĂTRAT 3/4"
---------	-------------

TUBULARĂ Pt. ROATA DIN FAȚĂ SCANIA

52925	1,95	1	8	1.500
112,50€	Kg			

Extragerea piulițelor axurilor



80mm	8 FEȚ
PĂTRAT HEX 41mm	

TUBULARĂ PENTRU EXTRAGEREA ROATA SCANIA

52926	2,93	1	24	1.500
143,50€	Kg			

Extragerea piuliței axelor



100mm	8 FEȚ
PĂTRAT 3/4"	

TUBULARĂ PENTRU EXTRAGEREA ARBALETA

52927	0,78	1	20	1.000
49,20€	Kg			



34x56mm	PĂTRAT 3/4"
---------	-------------

TUBULARĂ Pt. ROATA DIN FAȚĂ SCANIA

52928	2,01	1	10	1.500
114,00€	Kg			

Extragerea piuliței in osie frontală



80mm	8 FEȚ
PĂTRAT 3/4"	

TUBULARĂ PIULIȚĂ Pt. ROATĂ SCANIA

52929	2,68	1	4	1.500
122,50€	Kg			

Extragerea piuliței in axul al treilea in camioane de 10 axe



95mm	8 FEȚ
PĂTRAT 3/4"	

UTILE VEHICULE GRELE

UTIL Pt. INSTALAREA RACORDULUI DIN SPATE A ULEIULUI ÎN ARBORELE COTOT LA SCANIA

52930	2,86	1	4	1.500
97,80€	Kg			



SCANIA 310/320

RACORD 0366303-R

TUBULARĂ PIULITA COLIVIE CAMION BENZ / MAN

52934	2,05	1	1.000
76,30€	Kg		



56mm

PĂTRAT 3/4"

TUBULARĂ PIULITA COLIVIE CAMION

52935	2,80	1	10	1.500
81,00€	Kg			



60mm

PĂTRAT 3/4"

TUBULARĂ PENTRU EXTRAGEREA PIULITEI DIRECȚIEI LA CAMION BENZ / MAN

52938	3,22	1	6	1.500
140,40€	Kg			

Pentru extragerea piuliței axului de la direcție



100mm

6 CRENELURI ÎNLĂNȚUITE

PĂTRAT 3/4"

UTIL PENTRU ROTIREA VOLANULUI DE MOTOR

52942	0,87	1	20
70,20€	Kg		



Pentru Mercedes Actros și Atego.
Pentru MAN de 5,6 și 8 cilindri.

TUBULARĂ CAMION SCANIA Pt. ROTIREA ARBORELU CU CAME

52931	0,23	1	30	1.499
33,10€	Kg			



PĂTRAT 1/2"

TUBULARĂ EXTRAGERE BUCȘA CAMION BENZ / MAN

52936	1,35	1	10	1.000
137,70€	Kg			

Folositoare pentru furgonete



80-95mm

6 CRENELURI ÎNLĂNȚUITE

TUBULARĂ PENTRU EXTRAGEREA SUPAPEI DE INJECTIE SCANIA / BENZ / MAN

52939	0,18	1	30	1.500
24,30€	Kg			



22-28mm

DIESEL

4 CRENELURI ÎNLĂNȚUITE

UTIL PENTRU ROTIREA VOLANULUI

52943	0,49	1	30	1.500
64,80€	Kg			



TUBULARĂ PENTRU SUPAPA DE INJECTIE ELECTRO MAGNETICĂ

52932	0,47	1	20	1.500
33,50€	Kg			



Ø 38

PĂTRAT 1/2"

TUBULARĂ EXTRAGEREA BUȘEI DIN SPATE LA CAMION BENZ / MAN

52937	0,73	1	24	1.500
189,00€	Kg			

Extragerea bușelor axului din spate



95-115mm

6 CRENELURI ÎNLĂNȚUITE

TUBULARĂ CAMION BENZ / MAN PENTRU DIFERENȚIALUL PIULIȚEI DIN SPATE

52940	4,34	1.500
170,10€	Kg	



104mm 6 CRENELURI ÎNLĂNȚUITE

PĂTRAT 3/4"

EXTRACTOR PIVOTI CAMION ȘI VEHICULE COMERCIALE

52944	0,94	1	20	1.500
86,40€	Kg			



30mm

TUBULARĂ DE BUCȘA SCANIA

52933	3,05	1	5
133,60€	Kg		



SCANIA 420

8 CRENELURI ÎNLĂNȚUITE

PĂTRAT 3/4"

Ø Exterior: 11,6cm
Ø Interior: 10cm

TUBULARĂ BUCSE PENTRU IVECO

53430	2,90	1	8
203,80€	Kg		



IVECO

12 FEȚ

118X134mm

Ø Exterior: 134mm
Ø Interior: 110,5mm

UTIL PENTRU ROTIREA VOLANULUI DE MOTOR

52941	0,54	1	20	1.500
54,00€	Kg			

Pentru Benz de 6, 8 și 10 cilindri.
Pentru MAN de 12 cilindri.



EXTRACTOR PIVOTI CAMION ȘI VEHICULE COMERCIALE

52945	2,74	1	24
178,20€	Kg		



39mm



07



CAROSERIE

SET PENTRU TINICHIGERIE	112	VENTUZE	117
CASCĂ PENTRU SUDURĂ	113	CENTURĂ CU ÎNTINZĂTOR	117
SETURI DE PÎRGHII	113	SUPORT PENTRU VOPSITORIT	118
SET DE USTENSILE PENTRU DESCHIDEREA MAȘINILOR	114	SUPORT	118
USTENSILĂ PENTRU ÎNLOCUIREA PARBRIZELOR	114	CĂRUCIOR PENTRU A DEPOZITA PIESE . .	118
CLEȘTE.	115	BOBINE	119
PISTOL PENTRU SILICON	116	HUSE DE PROTECȚIE PENTRU PICIOARE . .	119
		HUSE DE PROTECȚIE.	119
		COVORAȘ	120

SET TINICHIGERIE 7 PIESE

7
PCS

52876 3,13 6 84
153,90€ Kg



ACOPERIT
CUPLASTIC



REF.	DESCRIÇÃO	Kg	Paq	Pcs	€
12955	NICOVALĂ CURBATA PENTRU TINICHIGERIE	0,29	25	99	27,80€
12956	NICOVALĂ PROFILATA PENTRU TINICHIGERIE	0,31	25	99	27,80€
12957	NICOVALĂ BOMBATA PENTRU TINICHIGERIE	0,37	25	99	27,80€
12958	NICOVALĂ PANĂ PENTRU TINICHIGERIE	0,41	25	99	27,80€
12959	NICOVALĂ VIRGULA PENTRU TINICHIGERIE	0,30	25	99	27,80€
12960	NICOVALĂ CALCAI PENTRU TINICHIGERIE	0,18	25	99	27,80€
12961	NICOVALĂ VIRGULA CU MĂNER PENTRU TINICHIGERIE	0,34	25	99	27,80€

SET DE TINICHIGERIE PENTRU CAROSERII AUTO

51131 5,03 5 100
47,70€ Kg



REF.	DESCRIÇÃO	Kg	Paq	Pcs	€
11541	CIOCAN CU CAP LAT	0,43	5	25	5,40€
11542	CIOCAN CU CAP LAT	0,38	5	25	5,40€
11543	CIOCAN CU CAP LAT CONIC	0,42	5	25	5,40€
11544	TAS VERTICAL	0,69	5	25	5,00€
11545	ARIPA TAS	0,79	5	25	5,00€
11546	TAS DOUĂ MARGINI	0,81	5	25	5,00€
11547	PANĂ TAS ÎN 8	0,81	5	25	5,00€

SET REPARATOR DE LOVITURI

N

53224 3,90 5 20
153,45€ Kg

32
PCS

1 pistol adeziv (220-240V ~, 50Hz, 40W).
1 ciocan glisant pentru extragerea dents adânci.
1 dents stivuitor pentru extragerea urme de lovituri minore pe suprafețe plane.
1 lipici de curățare.
1 racletă pentru laextracción neted filele lipici.
8 bare negre lipici (11 x 200mm).
19 lenguetas de clei în diferite dimensiuni și forme.

REF.	DESCRIÇÃO	Kg	Paq	Pcs	€
13842	SET DIN 5 SOPORTURI ALBASTRE	0,05	10	100	4,60€
13843	SET DIN 4 SOPORTURI GALBENE	0,05	10	100	3,30€
13844	SET DIN 10 SOPORTURI ROȘII	0,05	10	100	6,60€
13845	SET DIN 5 TIJE DE ÎNCLEIERE	0,10	10	100	4,80€



13842



13843



13844



13845



CASCĂ PENTRU SUDURĂ CU REGULATOR MANUAL

N

53414	-	4	-
49,25€	Kg	ff	ff



CASCĂ PENTRU SUDURĂ CU REGULATOR DIGITAL

N

53415	-	4	-
152,35€	Kg	ff	ff



SET CU 27 CHEI DIN NAILON

52788	1,18	10	120	27 PCS
42,90€	Kg	ff	ff	



Set cu 27 chei din nailon cu diferite curbe și finaluri care facilitează activitatea atât în interior cât și în aer liber ale vehiculelor. Gama largă vă permite să utilizați instrumentul potrivit pentru fiecare loc de muncă și piesă, facilitând lucrul în locurile greu accesibile.

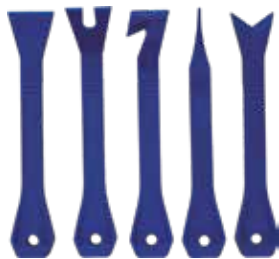

SET DE 5 PERNUȚE PNEUMATICE PENTRU DESCHIS MAȘINI

52077	0,35	5	40	240
57,70€	Kg	S6	ff	ff

Introducerea acestora între geamul și cadrul ușii permite deschiderea ușoară a vehiculului și fără deteriorarea acestuia.

4 - 5cm



Conține:
Pernuță de 16x16cm
Pernuță de 32x12cm
Pernuță de 19x6cm
Pernuță de 18x4,5cm

Presiune maximă acceptată: 100 Kg

LEVIER DE COFRAJ

51360	0,75	20	150
5,60€	Kg	ff	ff

18" x 5/8

51361	1,45	20	150
9,80€	Kg	ff	ff

24" x 3/4

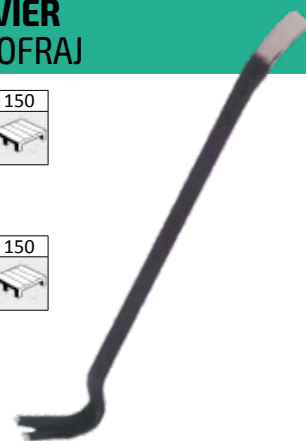

JOC DE 4 LEVIERE FOARTE LUNG

52977	8,61	1	48
98,00€	Kg	ff	ff

900 x 16mm (36") 0°
900 x 16mm (36") 30°
900 x 16mm (36") 75°
900 x 16mm (36") 90°



SET 2 LEVIERE

52851	0,24	20	80	960	
8,10€	Kg				



JOC DE 2 LEVIERE EXTRALUNGI

52026	2,04	10	200	
24,00€	Kg			

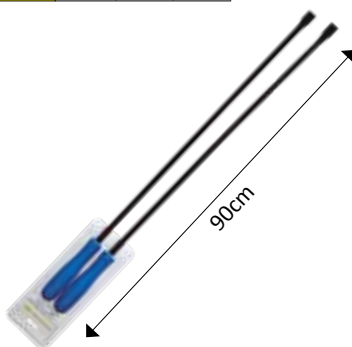

SET DE 4 LEVIERE FINE DIN PLASTIC

51832	0,55	12	24	192	
19,50€	Kg				



SET DE 5 LEVIERE CU MÂNERE DIN PLASTIC

50903	2,00	4	8	200	
23,80€	Kg				

60, 43, 38, 28, 18mm

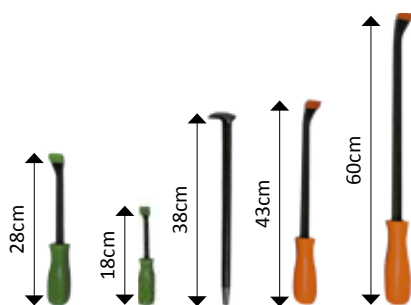

SET 5 LEVIERE DIN PLASTIC DEMONTARE TAPIȚERII

50901	0,40	5	20	240	
17,00€	Kg				



SET DE 6 PÂRGHII

53110	1,42	12	144	
22,00€	Kg			

5" 8.5mm, 5" 10.3, 5" 4.5,
15" 8.5, 15" 10.3, 15" 4.5mm

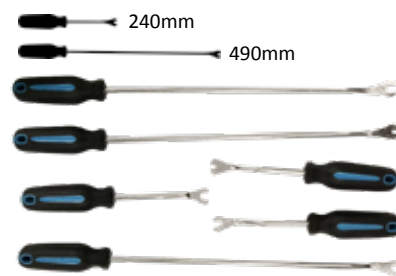

SET DE USTENSILE PENTRU DESCHIDEREA MAȘINILOR

N

53230	5,25	1	40	
15,45€	Kg			

8 PCS



USTENSILĂ PENTRU ÎNLOCUIREA PARBRIZELOR

N

53232	1,15	10	160	
39,05€	Kg			



13813 4,70€
CABLU PENTRU EXTRAGEREA LICHIDULUI DE PARBRIZE PENTRU REF. 53232

13814 7,00€
UNELTE DE EXTRAGERE PARBRIZE PENTRU REF. 53232

CLEȘTE TINICHIGERIE AUTOBLOCANT

52505	0,27	36	72	2.160
12,50€	Kg	sub	ff	

PREZENTARE ÎN CUTIE

0-55mm



170mm

CR-MO



CLEȘTE TINICHIGERIE AUTOBLOCANT TIP C

52506	0,29	36	72	2.160
13,60€	Kg	sub	ff	

PREZENTARE ÎN CUTIE

0-50mm



170mm

CR-MO



CLEȘTE SUDURĂ AUTOBLOCANT TIP C

52512	1,32	36	20	280
37,40€	Kg	sub	ff	

PREZENTARE ÎN CUTIE

0-210mm



440mm

CR-MO



CLEȘTE SUDURĂ AUTOBLOCANT

52511	1,32	20	280
36,30€	Kg	ff	

PREZENTARE ÎN CUTIE

0-225mm



440mm

CR-MO



CLEȘTE TINICHIGERIE CU FĂLCI PLATE

52507	0,77	5	30	420
20,70€	Kg	sub	ff	

PREZENTARE ÎN CUTIE

0-80mm



250mm

CR-MO



CLEȘTE MENGHINĂ PENTRU SUDURĂ

52504	0,69	30	480
19,10€	Kg	ff	

PREZENTARE ÎN CUTIE

0-60mm



225mm

CR-MO



CLEȘTE SUDURĂ AUTOBLOCANT TIP C

52503	0,85	10	30	540
23,70€	Kg	sub	ff	

0-105mm



280mm

CR-MO



CLEȘTE CU CIOC LUNG AUTOBLOCANT

52510	0,47	10	30	420
26,20€	Kg	sub	ff	

0-150mm



285mm

CR-MO



CLEȘTE SUDURĂ AUTOBLOCANT

52502	0,84	10	30	540
22,40€	Kg	sub	ff	

0-110mm



280mm

CR-MO



CLEȘTE REGLABIL AUTOBLOCANT

50577	0,47	5	40	800	230mm
9,00€	Kg	sub	ff		CR-MO



CLEȘTE AUTOBLOCANT CU CIOC GHEARĂ

52386	0,44	10	50	1.500
19,00€	Kg	sub	ff	

Până la 6 dimensiuni diferite de piulițe/șuruburi hexagonale.



52386
LISO



52387
ZIMȚAT

52387	0,44	10	50	1.000
19,80€	Kg	sub	ff	



CLEȘTE SPECIAL SUDURĂ

52390	0,50	5	40	640	250mm
28,40€	Kg	sub	ff		CR-MO



CLEȘTE SPECIAL AMBREIAJ

52388	0,82	5	20	320	305mm
22,50€	Kg	sub	ff		CR-MO



TERMINAT ÎN UNGHII

CLEMĂ DE TRAGERE CAROSERII CU AUTOSTRĂNGERE

52477	2,60	6
55,90€	Kg	ff

5T

0-60mm



CLEMĂ DE TRACȚIUNE CU DUBLĂ TRĂGERE

52478	2,75	6
49,00€	Kg	ff

5T

0-20mm



CLEMĂ DE TRACȚIUNE MINI

52479	1,18	10
40,80€	Kg	ff

3T

0-20mm



CLEMĂ DE TRAGERE CAROSERII

52474	3,49	5	1.500
52,00€	Kg	ff	ff

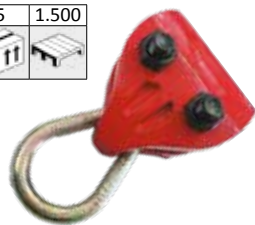

CLEMĂ DE TRAGERE CAROSERII ÎNGUSTĂ

52475	3,60	10	1.500
49,90€	Kg	ff	ff

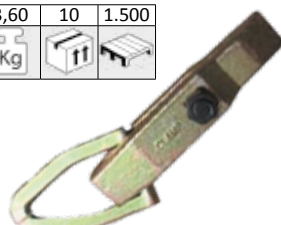

CLEMĂ DE TRAGERE CAROSERII

52476	3,04	6	1.500
49,80€	Kg	ff	ff

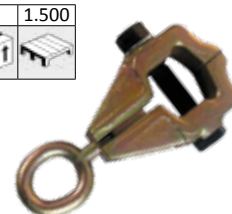

CLEMĂ DE TRAGERE PĂTRATĂ 90°

52480	2,00	9	0-25mm
43,80€	Kg	ff	ff



CLEMĂ DE TRAGERE PĂTRATĂ

52481	1,91	9	0-20mm
41,80€	Kg	ff	ff



CLEMĂ DE TRAGERE CU UNGHII DE 45°

52482	2,13	9	0-10mm
43,80€	Kg	ff	ff



CLEMĂ DE TRAGERE LATĂ MINI

52483	2,13	9	0-110mm
40,80€	Kg	ff	ff



JOC DE 6 CLEȘTI CU PRINDERE SPECIALĂ

52385	3,72	6	120
147,50€	Kg	ff	ff



Clește Tip W 195mm,
Clamă dublă curbată 215mm,
Clamă dublă în unghi 225mm,
Clamă în unghi închis 210mm,
Clește Tip "L" 195mm,
Clește în unghi de 90° 195mm.

CLEMĂ DE TRACȚIUNE

52487	2,75	6
50,20€	Kg	ff



CÂRLIG DUBLU PENTRU CAROSERII

52484	1,19	11
52,80€	Kg	ff



CÂRLIG CU LANȚ TRAS CAROSERII

52485	1,17	11	1.080
43,10€	Kg	ff	ff



CÂRLIG DUBLU CU LANȚ TRAS CAROSERII

52486	1,21	11
48,00€	Kg	ff

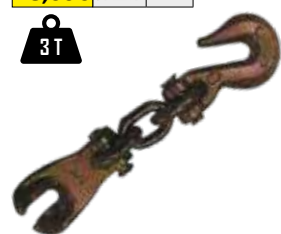

PISTOL PENTRU SILICON

52531	0,36	20	240	300ml
5,60€	Kg	ff	ff	9"



PISTOL PROFESIONAL PENTRU SILICON

52533	0,74	20	120	300ml
7,60€	Kg	ff	ff	9"



PISTOL ELECTRIC PT. SILICON CU BATERIE

52674	2,59	1	4	48	300ml
110,60€	Kg	ff	ff	ff	9"

Cu baterie



VENTUZĂ

UNITARĂ

52262	0,31	10	40	320
6,20€	Kg	sub	ff	ff



52262

52263

DUBLĂ

52263	0,59	6	24	240
11,50€	Kg	sub	ff	ff



TRIPLĂ

52264	0,92	6	10	100
17,40€	Kg	sub	ff	ff



52264

52265

CVADRUPLĂ

52265	1,24	5	10	100
20,00€	Kg	sub	ff	ff



SET DE 2 VENTUZE

52268				
11,00€				

Kg	0,19
sub	10
ff	20
ff	360



SET DE 2 MINI VENTUZE

52295				
5,00€				

Kg	0,15
sub	5
ff	100
ff	900



VENTUZĂ DE EXTRAȚIE CU MÂNER

52589	0,28	10	40	720
9,60€	Kg	sub	ff	ff

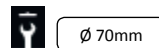

VENTUZĂ DUBLĂ ARTICULATĂ

52765	0,87	10	120
22,00€	Kg	ff	ff

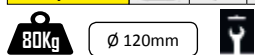

Destinată pentru întreținerea, instalarea și îndepărtarea părților vehiculului, atât tablă cat și sticlă.
Permite o manevrare ușoară și se adaptează la posibile imperfecțiuni ale suprafeței.

CENTURĂ CU ÎNTINZĂTOR ȘI CLICHET

5m x 25mm

52321	0,4	5	20	1.200
10,40€	Kg	sub	ff	ff

8m x 25mm

52327	0,46	20	840
12,00€	Kg	ff	ff



SET DE VENTUZE CU CLICHET

52998	2,03	8	1.500
55,20€	Kg	ff	ff



5m x 25mm



VENTUZĂ DUBLĂ EXTENSIBILĂ

52267	1,07	20	80
28,00€	Kg	ff	ff



PREZENTAREA ÎN CUTIE ALB

SUPORT PENTRU VOPSITORIE

53134	14,70	1	36
95,00€	Kg	ft	ft

1770mm	500mm
--------	-------



6 cârlige pentru a atășa bucăți la vopseala sau uscare.
Cadru reglabil, care se extinde de la 127cm la 203cm.



SUPORT BASCULANT VOPSITORIE

53126			
153,00€	20,30	1	21
Kg	ft	ft	ft

Ideal pentru usi, bare de protecție, claponi; flapsurile, spoiler, etc.

6 brațe care dețin
4 cu cârlig
2 gaura fixă.



SUPORT PLIABIL PT. ELEMENTE

52749	6,25	1	29
49,00€	Kg	ft	ft

80cm	58cm
------	------

11959 **2,90€**

SPUMĂ PENTRU SUPORTUL
CU REF. 52749



SUPORT DE SUȚINERE CAROSERII ÎN "X"

53079	6,77	1	44
69,50€	Kg	ft	ft

MĂSURI DESFĂȘURAT

660mm	600mm	870mm
-------	-------	-------

MĂSURI DE PLIERE

1140mm	600mm	300mm
--------	-------	-------

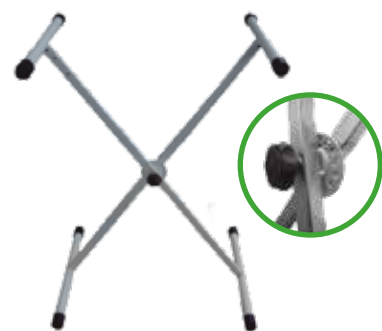

SUPORT DE SUȚINERE PENTRU PARBRIZ MAȘINĂ

53080			
67,30€	7,87	1	45
Kg	ft	ft	ft

Ansamblu estacadă cu ventuză
din cauciuc moale.

MĂSURI DE PLIERE

1130mm	990mm
--------	-------



SUPORT DE SUSȚINERE CAROSERII

53124			
205,00€	21,10	1	11
Kg	ft	ft	ft



MĂSURI RIDICATE

Min: 840mm
Max: 1320mm

MĂSURI LUNGI

Min: 225mm
Max: 1380mm



CĂRUCI PENTRU A DEPOZITA PIESE

53125	51	1
335,00€	Kg	ft

1800mm	895mm	585mm
--------	-------	-------



SUPORT HÂRTIE

53123	2,60	5	35
44,50€	Kg	ft	ft

900mm	460mm	440mm
-------	-------	-------

Măsură Tub: Ø 18 x 1.2mm.
Lamă de tăiere: 0.7mm.

Potrivit pentru hârtie sub formă de
rulouri de până la 40 cm lățime.



SET SUPORT DE PERETE + MATERIAL PENTRU PROTEJAREA VEHICULELOR



SET COMPUS DIN REF.: 52065 ,
52244 , 52057 , 52058

50403	8,90	1	70
84,00€	Kg	ff	ff



SET COMPUS DIN REF. : 51985,
51978, 52057, 52058, 50409

50400	17	1	35
138,00€	Kg	ff	ff



SET COMPUS DIN REF. : 51985,
52244, 52057, 52058, 50409

50410	12,44	1	35
138,00€	Kg	ff	ff

SUPOORT DE PERETE PENTRU HUSE DE PROTECȚIE AUTO

51985	5,25	1	40
72,00€	Kg	ff	ff

NU INCLUDE BOBINA

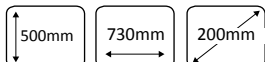

SUPOORT METALIC DE PERETE PENTRU ROLA CU HUSE DE SCAUNE

52065	1,71	1	63
32,00€	Kg	ff	ff

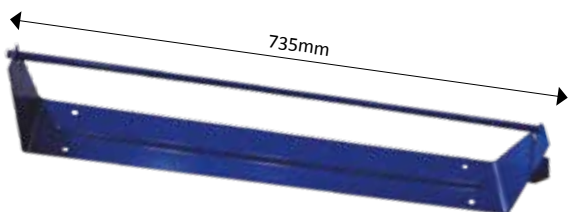

HUSE DIN HÂRTIE PENTRU PICIOARE ANONIME

50409	3,54	250	160
24,00€	Kg	ff	ff

250 uds

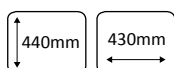

ROLĂ FOLIE ELASTICĂ PENTRU VOLAN

FOLIE ELASTICĂ

52057	0,62	24	672
4,40€	Kg	ff	ff

Lungime: 200m
Lățime: 12,5cm
Grosime: 23mc

MÂNER

52058	0,06	125	2.500
5,90€	Kg	ff	ff



HUSE DE PROTECȚIE DIN PLASTIC PENTRU VOLAN

51824	1,45	2	36
29,00€	Kg	ff	ff

250 uds



SET DE ÎNTREȚINERE AUTO ÎN PUNGĂ INDIVIDUALĂ

50916	0,07	100	400	4.800
1,10€	Kg	ff	ff	ff

Calitate: 20mc



DISTRIBUITOR



ROLĂ CU HUSE DE PROTECȚIE

ACOPERIRE EXTINSĂ A
SCAUNULUI



MODEL CUIDAMOS (SPANIOL) / FĂRĂ POALĂ

51978	6,53	4	56	18mc
56,00€	Kg			250 U.

MODEL CUIDAMOS (SPANIOL) / CU POALĂ

51624	10,21	1	36	20mc
140,00€	Kg			250 U.

MODEL CUIDAMOS (SPANIOL) / CU POALĂ

51627	7,44	1	36	30mc
122,00€	Kg			125 U.

MODEL DESEN ANONIM / FĂRĂ POALĂ

52244	8	1	42	25mc
58,00€	Kg			250 U.



51978

52244

HUSĂ DE TAPIȚERIE

N

53226

10,75€

Kg	0,30
	5
	50
	900

Nylon



HUSĂ AUTO PROTECȚIE MAGNETIZATĂ

51622

12,20€

0,43	30	560
Kg		

PERSONALIZATE:
Dimensiuni maxime
personalizare: 40x20cm

Două fețe:
una catifelată / una plastică
Dimensiuni: 110 cm / 64 cm
4 puncte magnetizate



SALOPETĂ DE PROTECȚIE DE UNICĂ FOLOSINȚĂ

N

53413

3,75€

0,15	50	400
Kg		

T. XL

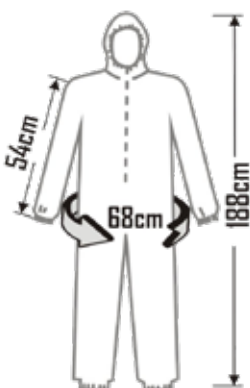

COVORAȘ

N

PLIABIL

53192

43,00€

0,70	2	80
Kg		

Spumă.

Măsurătorile saltelei pliate:
20cm x 40,5cm x 12,5cm.

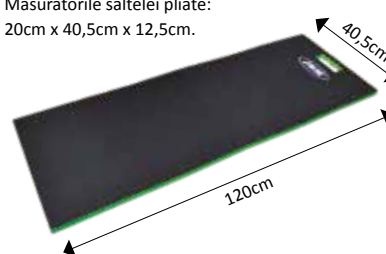

INDIVIDUAL

53191

10,00€

0,15	5	215
Kg		



31cm x 47cm.
Spumă.



08



UTILAJ

PRESĂ PENTRU PISTOANE DE FRÂNĂ . . .	122	EXTRACTOARE DE PAPUCI ELECTRICI	142
APARAT AUTOMAT PENTRU AERISIT ȘI		TRUSĂ PENTRU DEMONTAT RULMENȚI . .	143
SCHIMBAT LICHIDUL DE FRÂNĂ	123	CHEI DINAMOMETRICE	145
EXTRACTOARE PENTRU FILTRE DE ULEI . .	124	MĂSURAREA	147
BAIE DE ULEI	127	MULTIPLICATOR DE FORȚĂ	148
EXTRACȚIE INJECTOARE	128	CENTRATOR AMBREJAIE	149
TRUSĂ FREZE CURĂȚAT INJECTOARE . . .	131	SISTEMUL DE RĂCIRE	150
TRUSĂ REPARAȚIE FILETE	132	AER CONDIȚIONAT	151
COMPRESOR DE PRESIUNE	133	DIRECȚIE	152
PREZOANE ANTIFURT	134	SUSPENSIE	153
CHEIE PENTRU BUJIE	136	PERIE	155
TRUSĂ CHEI PENTRU ALTERNATOR	137	CERCURI DE PISTON	156
TRUSĂ DE MONTAT /DEMONTAT AIRBAG .	139	STETOSCOPI	157
EXTRACTOARE DE PIVOȚI (ROTULE)	139	MATRIȚE	157
EXTRACTOARE GHILOTINĂ	140	BARRAS / COLGADORES IMANTADOS . . .	159
EXTRACTOARE CU GHEARE	141		

PRESĂ PENTRU PISTOANE DE FRÂNĂ

52636	3,16	5	75	16 PCS
126,80€	Kg			

Pistol pentru rotirea și apăsarea pistoanelor de frână (x1)

Adaptoare (x15):

Adaptoare de 13/32" cu pătrat de 3/8" // - GM Motors, Citroën // - GM Motors (x2) // - Citroën XM, Xantia // - Alfa Romeo, Audi, Austin, MBW, Ford, Honda, Jaguar, Mercedes-Benz, Mitsubishi, Nissan, Rover, Toyota, VW. // - Alfa Romeo 164 2,0, Ford, Mazda, Saab 9000, Subaru. // - Nissan Primera, VW - Golf IV // - Audi 80, 90, V8 + 100, Ford Sierra ABS + Scorpio ab 85, Honda Prelude, Nissan Silvia 1.8 turbo, Rover 8000, Saab 9000, Subaru L + Z, VW - Golf + passat // - Ford // - Saab, Honda // - Renault // - Cefiro, Maxima // Opel // - Citroën



PRESĂ PENTRU PISTOANE DE FRÂNĂ



53231	2,70	5	22 PCS
29,90€	Kg		

22
PCS



PRESĂ PNEUMATICĂ PENTRU PISTOANE DE FRÂNĂ

51283	1,33	10	120	64,00€
	Kg			

resiune normală de uz: 5 - 8bar
Presiune maximă de lucru: 14bar



PRESĂ PENTRU PISTOANE DE FRÂNĂ

52330	5,68	4	60	50 PCS
226,00€	Kg			

Opel, Citroën, Peugeot, Renault

CONȚINE:

3 rulmenți de presiune pentru a lucra în locurile cu puțin spațiu

Pipetă de ulei

Listă cu modelele de autovehicule compatibile

35 adaptoare pentru autovehicule



PRESĂ PENTRU PISTOANE DE FRÂNĂ

51059	4,62	5	100	37 PCS
132,50€	Kg			

CONȚINE:

2 chei hex. de 6 și 7 mm

2 plăci pentru sistemul de frânare de la Mercedes și Opel

6 rulmenți de presiune pentru a lucra în locurile cu puțin spațiu

Pipetă de ulei

Listă cu modelele de autovehicule compatibile

26 adaptoare pentru autovehicule



TRUSĂ PENTRU REPARAREA / ÎNTREȚINEREA FRÂNELOR

52434	3,05	5	80
189,00€	Kg	ff	ff

CONȚINE:

Chei pentru montat și demontat arcuri la saboți și frână
Clești pentru arcuri saboți de frână
Șurubelniță de impact
Șurubelniță cu articulație universal
Unealtă special frână
Perie de curățare
Perie de curățare cu alarmă
Clește pentru cablu de frână
Pilă pentru clește de frână



PRESĂ PENTRU PISTOANE

52906			
76,20€			

Kg	1,30
ff	5
ff	500



12974



12975

REF.	DESCRIERE	Kg	ff	€
12974	PIESĂ DE SCHIMB 2 PINS SET PENTRU PISTOANE DE FRÂNĂ UNIVERSAL	0,15	50	21,00€
12975	PIESĂ DE SCHIMB 3 PINS SET PENTRU PISTOANE DE FRÂNĂ UNIVERSAL	0,17	50	23,00€

Alfa Romeo 164 2,0, Ford, Mazda, Saab 9000, Subaru, Nissan Primera, VW, Audi, Ford Sierra ABS + Scorpio ab 85, Honda Prelude, Nissan Silvia 1.8 turbo, Rover 8000, Saab 9000, Ford, Opel, BMW, Lancia, Proton, Renault, Rover, Peugeot 307, 308 A3- Iveco Daily, Volkswagon Passat 2.0 TDI 09-, Renault Laguna.

SET DE LERE PENTRU PASTILE DE FRÂNĂ

52455	0,26	20	40	864
16,00€	Kg	sub	ff	ff



COLOR	METRIC	SAE
Green	8-10-12mm	0.3150-0.4720"
Yellow	4-5-6mm	0.1575-0.2382"
Red	2-3mm	0.0787-0.1181"

APARAT AUTOMAT PENTRU AERISIT ȘI SCHIMBAT LICHIDUL DE FRÂNĂ

52191	9,41	1	12
340,00€	Kg	ff	ff



INCLUIE DOPURI PENTRU APARATUL AERISIT SISTEMUL DE FRÂNARE REF. **52328**

Presiune (reglabilă) de lucru: de 0 la 4 kg / cm²
Intrare și ieșire de ½"
Greutate: 5kg
11+2 adaptoare
Gamă aplicații: GM, Chrysler, Nissan

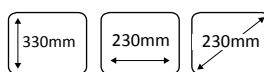

DOPURI PENTRU APARATUL AERISIT SISTEMUL DE FRÂNARE

Pentru vehicule GM, Chrysler, GM, Nissan

52328	0,75	6	120
99,00€	Kg	ff	ff

9 Adaptoare de ulei pentru frâne: Universal n°1, n°2, n°3, n°4

DISPOZITIV PENTRU SCHIMBAREA PLĂCUȚELOR DE FRÂNĂ

52315	0,88	5	25	360
22,00€	Kg	sub	ff	ff



Deschidere maximă: 80mm

APARAT MANUAL PENTRU SCHIMBAT LICHIDUL DE FRÂNĂ

52275	0,79	4	112
48,00€	Kg	ff	ff



Capacitatea balonului 0.75 litri
Temperatura de lucru: 10°C la 50°C
Mâner de silicon: 1m
Pistol de suflat cu intrare 1/4"
Presiune aer:
6-12 bar (87 - 174 psi)
Consum de aer: 180litri/min.



FILTRE ȘI FRÂNELE

JOC DE EXTRACTOARE PENTRU FILTRE DE ULEI

51332	3,82	5	60
109,10€	Kg		

**23
PCS**



REF.	Nr DE PIEȘĂ	CARACTERISTICI	Ø x CANTOS	Kg			€
11374	901	Toyota, Nissan, Fiat Daihatsu	65mm x 14	0,10	5	20	4,60 €
11375	902	Toyota, Daihatsu	67mm x 14	0,08	5	20	4,60 €
11376	903	VW, Mercedes, BMW, Opel, Audi	74mm x 14	0,09	5	20	4,60 €
11377	903-1	GM/AC, Wix, Ford, Isuzu	75mm x 15	0,09	5	20	4,60 €
11378	903-2	VW, Audi, Seat, BMW, Renault	74mm x 8	0,09	5	20	4,60 €
11379	903-3	Audi, Rover, Chrysler	74mm x 15	0,11	5	20	4,60 €
11380	903-4	Toyota, Lexus	73mm x 14	0,11	5	20	4,60 €
11381	903-6	Schlepper, Baumashinen	75mm x 12	0,10	5	20	4,60 €
11382	918	Rover, Chrysler, Audi	74mm x 15	0,11	5	20	4,60 €
11383	904	Nissan, Ford	79mm x 15	0,10	2	20	4,60 €
11384	905	GM, Chrysler	73mm x 15	0,12	5	20	4,60 €
11385	905-1	BMW, Mercedes, Opel, Audi, VW	74mm x 14	0,10	5	20	4,60 €
11386	906	Baummaschinen, Schlepper	84mm x 18	0,10	5	20	4,60 €
11387	907	Mitsubishi, Toyota	89mm x 15	0,13	5	20	4,60 €
11388	908	Nissan, Toyota	91mm x 15	0,14	5	20	4,60 €
11389	915	Honda Accord, Mitsubishi, Isuzu	90mm x 15	0,16	5	20	4,60 €
11390	910	Toyota, Alfa Romeo, Ford	95mm x 15	0,12	5	20	4,60 €
11391	911	Fiat, Renault, Citroën	76mm x 12	0,09	5	20	4,60 €
11392	911-1	Subaru, Toyota, Honda, Nissan	80mm x 15	0,09	5	20	4,60 €
11393	914	Mazda, Toyota	101mm x 15	0,18	5	20	4,60 €
11394	909	Isuzu, Nissan	92mm x 15	0,14	5	20	4,60 €

TUBULARE EXTRAȚIE FILTRU DE ULEI



52311	0,13	6	72	1.728
15,00€	Kg			

42mm	
GRUPO VAG	

52312	0,10	10	100	1.728
12,00€	Kg			

74x14C	
VW, MERCEDES, BMW, AUDI, OPEL	

52313	0,20	6	72	144
12,00€	Kg			

84x14C	
VOLVO 540, 650, 570, 580	

52314	0,28	5	50	600
14,00€	Kg			

87x16C	
BMW, VOLVO	
CASETA DE PREZENTARE	

52809	0,15	10	100	500
9,20€	Kg			

64,5mm	
TOYOTA	

SET DE 9 EXTRACTOARE FILTRU DE ULEI

52615	3,05	5	80
84,50€	Kg		

**9
PCS**

x8

x1

3/8"

1/2"

Audi, BMW, Mercedes, Opel, Renault, Volvo, Kia, Hyundai, Ford, VW, Skoda, Citroën, Mini

Extractor de 14 fețe: 64,5mm
 Extractor de 15 fețe: 88,8mm
 Extractor de 14 dinți: 74,2mm
 Extractor de 16 dinți: 86,6mm
 Extractor de: 27mm, 32mm, 36mm
 Cheie reglabilă cu sens dublu
 Rang de aplicație: 60-80mm



EXTRACTOR FILTRU DE ULEI PENTRU FORD, CITROËN, PEUGEOT 2.0, 2.2 HDI, TDCI

53008	0,06	5	30	1.500	
14,45€	Kg				



EXTRACTOR FILTRU DE ULEI CU PICIOR ROTUND / LAT

51352	0,34	10	40	1.200	
7,20€	Kg				

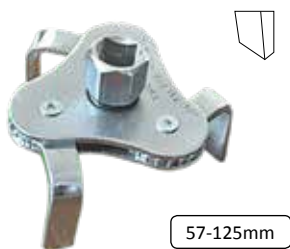

57-125mm

51353	0,57	10	20	1.120	
8,90€	Kg				

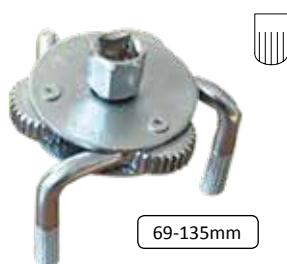

69-135mm

Se poate folosi cu cheie de 1/2" sau de 3/8" / Rang de 2-1/2" până la 4" (63-102 mm)
Extrage toate filtrele de ulei de 2-1/2" până la 4" de diametru

51923	0,56	20	40	1.020	
18,00€	Kg				

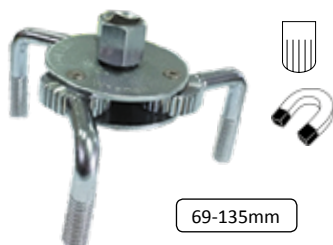

69-135mm

51934	0,38	40	1.200	
16,00€	Kg			

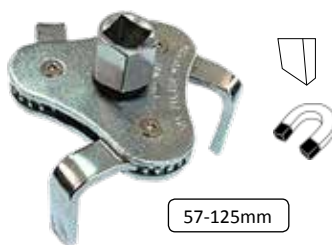

57-125mm

EXTRACTOR FILTRU DE ULEI DE CAMION

52518	1,40	12	480	
74,10€	Kg			

95-165mm



CLEȘTE PENTRU FILTRE DE ULEI

51354	0,43	10	900	
10,60€	Kg			

80-120mm



SET 5 JOJE PENTRU VERIFICAT NIVELUL DE ULEI LA BENZ/AUDI



53206	0,40	5	50	300	5 PCS
27,25€	Kg				

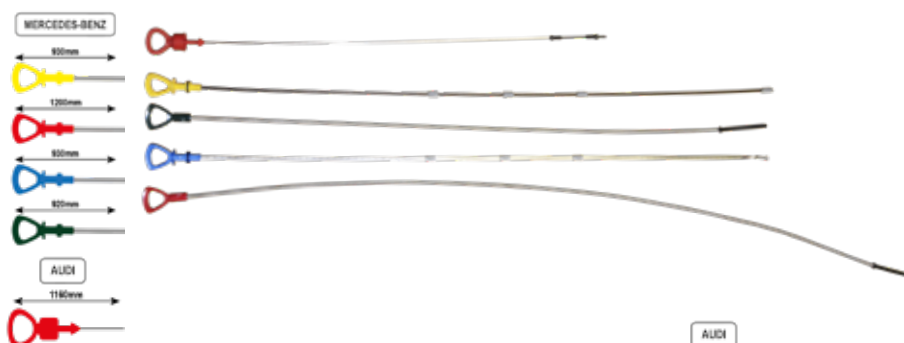

Pentru a verifica lichidul de transmisie a uleiului din motoarele Audi 100.
Vârful (primul 11 mm) arată lectura fluidului rece la 20 ° C.
A doua lectură este minimul la 80 ° C.
A treia lectură este la maxim 80 ° C.
Mențineți nivelul vehiculului la verificarea ATF.
Jojă pentru motor pentru a verifica nivelul uleiului, compatibil cu o gamă largă de motoare, din anul 1988 până în anul 2005, gama Mercedes.



13856	0,40	5	100	
7,80€	Kg			

EXTRACTOR FILTRU CU BANDĂ

52269	0,15	10	50	800		80-120mm
7,00€						

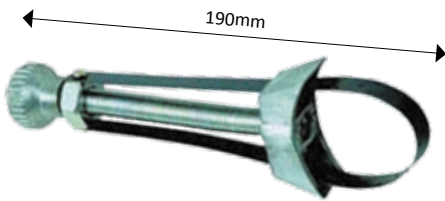

REF.	DESCRIERE	PENTRU			€
11106	SCHIMB 360mm	52269	0,02	50	3,00 €
11936	SCHIMB 383mm	52677	0,03	100	4,00 €
11937	SCHIMB 540mm	52678	0,04	100	5,00 €

EXTRACTOR DE FILTRU AJUSTABIL

52677	0,32		10	40	480		65 - 105mm
12,40€							

52678	0,33		10	40	480		65 - 105mm
13,00€							



EXTRACTOR FILTRU CU LANȚ

52417	0,87	5	25	650	
19,90€					

← 400mm → Ø 160mm

LANȚ DE MARE REZISTENȚĂ



SUPERFICIE DINȚATĂ PENTRU O PRINDERE OPTIMĂ

EXTRACTOR FILTRU CU CUREA

52416	0,34	5	50	1.050	
9,20€					

540 x 20mm Ø 150mm

CUREA DE POLIMER (REZISTENȚA MARE)



SUPERFICIE DINȚATĂ PENTRU O PRINDERE OPTIMĂ

EXTRACTOR FILTRE CU LANȚ

52607	0,86	6	24	432	
37,50€					

Ø 60 - 140mm



DUBLU LANȚ ARTICULAT



EXTRACTOR FILTRE CU LANȚ

52608	0,99	6	24	432	
42,50€					

Ø 60 - 195mm

CEL MAI LUNG DE PE PIAȚĂ



DUBLU LANȚ ARTICULAT



TRUSĂ CHEI BUȘON BAIE DE ULEI

52008	
36,00€	
Kg	1,25
Box	20
Tray	480



Pătrat: tubulară de 5/16" și de 3/8"
 Pătrat: tubulară de 7, 8, 10, 11, 12, 13 și 14 mm
 Triunghi: tubulară de 10 mm / Pătrat : tubulară de 10 mm
 Hexagonal: tubulară de 8, 9, 10, 12, 14 și 17 mm /
 Mâner + Dispozitiv de 165 mm



CHEIE PENTRU BAIE DE ULEI

52617	4,90	5	50	1.500	
4,90€	Kg	Box	Tray	Tray	



Citroën, Renault, Peugeot



SET REPARATOR DE FILETE PENTRU BUȘON

N

53235	
9,90€	
Kg	0,3
Box	10
Tray	40

53236	
11,55€	
Kg	0,30
Box	10
Tray	40

M - 13

M - 15



53237	
12,50€	
Kg	0,3
Box	10
Tray	40

53238	
14,85€	
Kg	0,40
Box	10
Tray	40

M - 17

M - 20



SET DE REPARAT FILETE BAIE DE ULEI

51337	1,58	10	150	50 PCS
68,00€	Kg	Box	Tray	



Dopuri de SKS3
 Filiere de 1 015
 Șaibe de Cupru

Conținut :
 Filiere: 1 unitate pe dimensiune
 Dopuri: 5 unități pe dimensiune
 Șaibe: 10 unități pe dimensiune

SET REPARAȚIE FILET BAIE DE ULEI

51403	0,13	1	M13
12,90€	Kg	Tray	x 1.5P
51400	0,17	1	M15
13,20€	Kg	Tray	x 1.5P
51401	0,15	1	M17
15,30€	Kg	Tray	x 1.5P
51402	0,10	1	M20
15,90€	Kg	Tray	x 1.5P



ULEI ȘI FRÂNE

APARAT PENTRU DEMONTAT SI MONTAT CURELE AUXILIARE POLI-V

51927	0,65	20	640
56,00€	Kg		

Pentru montarea-demontarea și extragerea curelelor auxiliare POLI-V cu ușurință. Adecvat pentru grupuri PSA și motoare Ford Fiesta 1.4/1.6, Citroën C4, Peugeot 307, Fiat Doblo, Dacia Logan. Instrument indispensabil pentru uz profesional. Proiectat pentru îndepărtarea recomandată și instalarea curelelor de transmisie elastice sau cu întindere automată montate la sistemele moderne de propulsie, cum ar fi alternator sau servodirecție.



TENSIOMETRU PENTRU CURELE DE DISTRIBUȚIE

52616	0,35	10	40	800
37,50€	Kg			

Două scări gradate (daN) cu citire din față și din spate



EXTRACTOR INJECTOARE DIESEL PARA CITROËN, PEUGEOT

53069			
112,00€	Kg	3,44	
		5	
		150	



CHEIE DUBLA CU CAP DESCHIS PENTRU INJECTOARE

52821	0,24	6	96
21,20€	Kg		

17mm



TRUSĂ EXTRAȚIE INJECTOARE

51494	3,63	5	125
96,30€	Kg		

Conține:
Extractor de impact : 1.75 kg
Adaptor pentru prinderea de structura interioară a injectorului: M17 x 1, 0
Adaptor pentru prinderea de filetul bobinei : M27 x 1, 0
Adaptor pentru prinderea injectorului în locul conductei de combustibil w/M12 x 1.75P.

Cu adaptor pentru motoare CDI și motoare Mercedes CDI OM 611, 612, 613 etc.
Construcția robustă permite reducerea drastică a injectoarelor blocate.
Material : oțel S45C.
Lungime totală : 350 mm

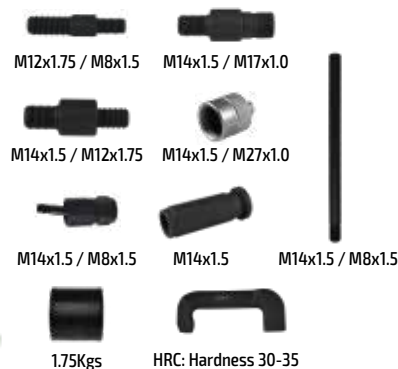

EXTRACTOR INJECTOARE PENTRU MERCEDES-BENZ

51498	3,63	5	125
118,00€	Kg		

SPECIAL INSTRUMENT PNEUMATIC

Aplicație: la motoare Mercedes-Benz CD611.612.613 ...etc

Pentru extragerea injectoarelor common rail strânse fără demontarea hiuloasei distribuției.

Special pentru cuplarea în instrument pneumatic. Extractor de injecție cu ciocan de impact, pentru tuburi de injecție care nu se încădrează bine, se poate extrage fără ajutorul demontării sau scoaterii blocajului din cilindru.



EXTRACTOR INJECTOARE PENTRU MERCEDES-BENZ CDI

51499	20,20	5	125
139,00€	Kg		

Extractor Injector Set pentru Mercedes CDI 4335

Acest set de șapte piese a fost special desenat pentru eliminarea

Injectoarelor de stubbon Mercedes Benz echipate cu motoare de vehicule CDI.



TRUSĂ EXTRACȚIE INJECTOARE

52858	20,45	1	33
248,00€	Kg		

Pentru extragerea injectoarelor diesel.
Adecvat pentru majoritatea injectoarelor diesel datorită multitudinii de adaptoare incluse.

Părți componente:

3 ciocane diferite:

1,6 kg - 160 mm lungime

2,7kg - 460 mm lungime

5,1kg - 600 mm lungime

Extractoare de gheare cu separare între padele 13,7 x 18mm, 105mm lungime
12,7x19mm, 130mm lungime

Mărimi: 25, 27, 28, 29, 30

Injector extractor M17x1.0

Adaptor cu filet exterior M27 x 1,0 y M25 x 1,0

Adaptor cu filet intern M27 X 1.0



EXTRACTOR UNIVERSAL PENTRU INTERIOARE/ EXTERIOARE



53250	4,80	2	80
89,15€	Kg		

Material: oțel

Extracție externă: 40 până la 80 mm

Extracție internă: de la 50 la 150 mm

Include:

- Extractor triplu extern
- Triple claw int. pentru extragerea rulmenților
- 1 extractor profund
- 1 conector cu șurub



EXTRACTOR DE TUBURI DE INECȚIE DIESEL

53009	0,50	4	20	560
36,10€	Kg			



14, 17, 19mm



EXTRACTOARE



TRUSĂ / TESTER VERIFICARE INJECTOARE

51493	0,96	5	80
84,00€	Kg	ff	ff

Scopul acestui instrument este de a măsura cu rapiditate și eficacitate cantitatea retur de combustibil a fiecărui injector în depozit, prin care se poate depista dacă vreun injector este afectat.

Adecvat pentru uz în Bosch, Siemens, Denso și Delphi injector.

6 eprubete pentru verificare în faza de pornire + 6 recipiente cu tub pentru verificare în relanti + Cutie de depozitare + Tuburi albe de retur



12901 5,20€
FLACON + CAPAC + FURTUN
PENTRU REF. 51493



EXTRACTOR PENTRU INJECTOARE MERCEDES

52629	1,24	50	440
84,50€	Kg	ff	ff



Specific pentru MERCEDES (C/E/S Class, VITO) MERCEDES / BOSCH Soluție injector. Extractor specific pentru injectoare MERCEDES, complet, cu conector pentru demontarea conexiunii cu electricitate.

SET 14 PIESE PENTRU SISTEME DE INECȚIE ȘI SONDĂ - LAMBDA

51491	3,89	5	150
143,00€	Kg	ff	ff



17x78mm (12PT): Renault
19x78mm (12PT): VW, Polo, Audi, Seat, Mazda
20x78mm (6PT): Deschis Japon
27x78mm (6PT): Deschis Japon
21x90mm (12PT): Seat, Audi, VW, Skoda, Alfa Romeo, Mitsubishi
22x78mm (12PT): Seat, Audi, VW, Skoda, Opel
22x110mm (12PT): Mercedes, Citroen, Peugeot, Ford, Nissan, Mazda, Mitsubishi, Seat, Audi, VW, etc

SET 7 PIESE PENTRU SISTEME DE INECȚIE ȘI SONDĂ - LAMBDA

51119	2,05	10	180
56,40€	Kg	ff	ff



Conține :
Tubulară de 1/2" de 29x9 la 90 mm lungă.
Tubulară de 1/2" de 7/8" la 50 mm lungă.
Tubulară de 1/2" de 27x12 la 78 mm lungă.
Tubulară 3/8" de 7/8" x 6 la 90 mm lungă.
Tubulară 3/8" de 7/8" x 6 la 80 mm lungă.
Tubulară de 3/8" de 7/8" la 30 mm lungă.
Tubulară de 3/8" de 1" și 1-1/16" la 74 mm lungă.

EXTRACTOR DE INYECTOARE PARA GRUPO VAG

52622	2,73	5	120
65,20€	Kg	ff	ff



Material: Cromo molibdeno SD45C.
Pentru motoare VW, Audi diesel.
Aplicații: 1.4 SDI, TDI, 1.9 D, SDI, TDI, TDI (PD), 2.0 TDI (PD) & (PD 4-VALVES), 2.5 TDI / TDI(PD), 2.8 TDI (PD), 2.7, 3.0 TDI (Common Rail), 4.2 TDI (Common Rail).

SET DE 2 DISPOZITIVE PENTRU ȘLEFUIREA SUPAPELOR

52850	0,11	6	72
6,20€	Kg	ff	ff

∅ 3,49-2,86mm
∅ 1,59-2,06mm



TUBULARE PENTRU POMPA INJECTOARE

53330	0,75	20	144
27,60€	Kg	ff	ff

5
PCS

1/2" 1/4" CR-V

BOSCH injection pump
TDI
Common Rail



CHEIE SONDĂ LAMBDA

52820	0,53	6	36
32,40€	Kg	5.6	11



22mm



Cheie hexagonală cu fereastra, permite extragerea senzorilor de oxigen amplasate în locuri inaccesibile.



HEDER ARTICULAT

52822	0,41	5	20
29,70€	Kg	5.6	11



22mm

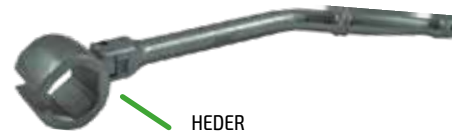

HEDER ARTICULAT

POMPA INIETTORE DIESEL

52801	0,13	5	50	1.500
21,90€	Kg	5.6	11	11



În timpul substituirii pompei de injecție, filtre sau alte părți, evitați înapoierea combustibilului în depozit.



TRUSA FREZE CURATAT INJECTOARE

52813	2,23	5	150
88,00€	Kg	11	11

17
PCS

Trusă de 17 freze pentru recondiționarea injectoarelor.

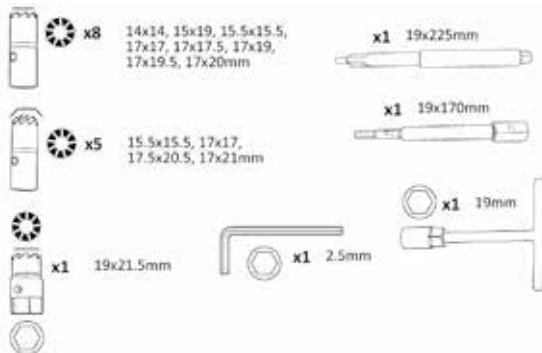

TRUSĂ FREZE CURĂȚAT INJECTOARE

52273	1,28	10	150
52,80€	Kg	11	11

8
PCS

Trusă de freze pentru curățat locaș injector diesel din chiuloasă. Conține 5 freze cu blocaj lateral, ax pentru centrarea frezelor și antrenor universal.

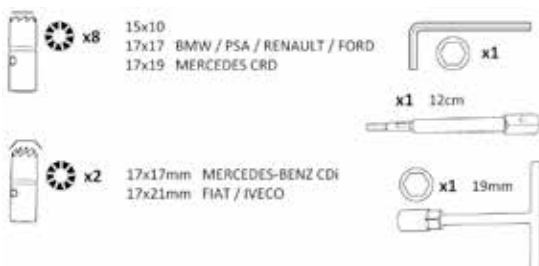

TRUSĂ REPARAȚIE FILETE

53041	0,67	10	1.000	M14x1,25	
38,10€	Kg				

BUJILE SPECIALE



51898	M18x2,5	
112,80€		

	1,81
	4
	252

M18x2,5

Conține:

- Burghiu
- Tarod
- Insertor filet
- Pin ghidare
- Set spirale din oțel inoxidabil

51899	M20x2,5	
131,00€		

	2,12
	4
	252

M20x2,5



REF.	DESCRIERE	Kg		x5	
52016	FILETE M5x0,8	0,05	10	2,10 €	
52017	FILETE M6x1,0	0,05	10	2,40 €	
52018	FILETE M8x1,25	0,05	10	2,60 €	
52019	FILETE M10x1,50	0,06	10	3,20 €	
52021	FILETE M12x1,75	0,06	10	3,40 €	

REF.	DESCRIERE	Kg		x5	
52022	FILETE M14x2,0	0,06	10	4,50 €	
52023	FILETE M16x2,0	0,08	10	6,60 €	
52024	FILETE M18x2,5	0,08	10	10,60 €	
52025	FILETE M20x2,5	0,08	10	13,00 €	

SET REPARAȚII FILETE

51896	2,20	5	10	300	115 PCS
110,00€	Kg				



Conține:

- 25 x M5x0.8
- 25 x M6x1
- 25 x M8x1.25
- 25 x M10x1.5
- 10 x M12x1.75

Conține pe dimensiune :

- 1 - Burghiu
- 1 - Tarod
- 1 - Insertor filet
- 1 - Pin ghidare
- 1 - Insertie filetată din oțel inoxidabil

SET REPARAȚII FILETE

51897	2,21	6	378	32 PCS
168,60€	Kg			



Conține:

- 9 x M12x1.75
- 9 x M14x2
- 9 x M16x 2.0

Burghiu

- Tarod
- Insertor filet
- Pin ghidare
- Insertii filetate din oțel inoxidabil

TRUSĂ REPARAT FILETE BUJII

52076	0,85	10
175,40€	Kg	



REF.	DESCRIPCIÓN	Kg		€
11893	FILET M8x1,0	0,01	100	6,40 €
11894	FILETM10x1,0	0,01	-	7,00 €
11895	FILET M10x1,25	0,01	-	7,60 €
11896	FILET M12x1,25	0,01	-	8,80 €

- A. Tarod M14 x 1,25 (pour M12 x 1,25 fil) - 1un. 1. Tijă de folosire - 2un.
 B. Tarod M12 x 1,25 - 1un. 2. Mâner pentru piesa 8 - 1un.
 C. Tarod M12 x 1,0 (filetage M10 x 1,25) - 1un. 3. Filet M8 x 1,0 - 5un.
 D. Tarod M10 x 1,25 - 1un. 4. Filet M10 x 1,0 - 5un.
 E. Tarod M10 x 1,0 (pentru filet M8 x 1,0) - 1un. 5. Filet M10 x 1,25 - 5un.
 F. Tarod M8 x 1,0 - 1un. 6. Filet M12 x 1,25 - 5un.
 7. Capete insertie - 3un.
 8. Adaptor filetat inserat - 1 un.

VERIFICATOR DE PRESIUNE ȘI VID

N

53426	0,90	16
25,15€	Kg	ft



TESTER COMPRESIE MOTOR DIESEL / PT. CAMIOANE

52685	3,45	6	90
74,00€	Kg	ft	ft

Kit completo para medir la compresión de vehículos diesel. Gran rango de adaptadores para medir en la mayoría de vehículos del mercado.

Sistema de enganche rápido para trabajos en puntos de difícil acceso.

Adaptador en ángulo y adaptador a roscas de M18 y M24.

Dispone de válvula de descarga y de sistema de retención de lectura.



COMPRESOR DE PRESIUNE ULEI

52754	1,31	10	160
62,00€	Kg	ft	ft

Útil para comprobar la presión de aceite y diagnosticar problemas en el sistema.

Incluye 10 adaptadores que cubren la mayoría de vehículos del mercado.

Rango de medición: 0-10Bar



M10x1.0mm
M12x1.5mm
M14x1.5mm
M16x1.5mm
M18x1.5mm



COMPRESMETRU BENZINĂ

52488	0,70	5	400
29,90€	Kg	ft	ft

Relej calibrado de doble lectura (0-300psi, 0-2000kpa) con válvula de descompresión.

Su sistema de enganche rápido permite una medición rápida y exacta en puntos de difícil acceso; el adaptador cónico permite el uso en la mayoría de vehículos del mercado.



TESTER COMPRESIE MOTOARE DIESEL

51893	4,25	3	45
398,00€	Kg	ft	ft

Diagnostic de comprimare pentru sisteme de injecție diesel. Rang de lucru până la 70 kg/cm² (1 000 PSI). Ceas de măsurare acoperit cu cauciuc, cu adaptoare în unghi și prelungitoare pentru lucrări în locuri de dificil acces.

Apt pentru uz în majoritatea motoarelor diesel de pe piață. Cu adaptoare de gama Alfa, BMW, Chrysler, Daewoo, Fiat, Ford, Hyundai, Izusu, LandRover, LDV, Mazda, Mercedes, Mitsubishi, Nissan, Opel, PSA, Renault, Suzuki, Saab, Toyota, VAG, Opel, Volvo diesel.

Injector: M20, M22, M24 și Ford



COMPRESMETRU PENTRU CIRCUITE DE BENZINĂ

51894	4,42	3	57
398,00€	Kg	ft	ft

Verifică diagnosticul de compresie într-un singur punct sau în mai multe puncte simultan.

Valabil pentru sisteme de injecție mecanice și electronice.

Format din 3 kituri de testare și 2 jocuri de combinare, acoperă majoritatea vehiculelor pe benzină de pe piață.



COMPRESMETRU DIESEL

52489	2,15	5	72
52,00€	Kg		

Kit complet pentru măsurarea compresiei de la vehiculele diesel. Gamă largă de adaptoare pentru măsurarea compresiei în majoritatea vehiculelor de pe piață. Sistem de cuplare rapidă pentru lucrări în locuri de dificil acces. Adaptor în unghi și adaptor la filete de M18 și M24. Dispune de supapă de descărcare și de sistem de reținere de lectură.



M18x1.5mm
M24x2.0mm
M24x1.5mm

M10x1.0x68mm
M10x1.25x54mm
M10x1.25x68mm
/M12x1.25x45mm

TRUSĂ REPARAȚIE BUJII INCANDESCENTE

52305			
149,00€			
Kg	1,79		
	10		
	240		

16 PCS



Extractor pentru bujii incandescente rupte în chiuloasă. Acest set conține 16 piese, este util pentru extragerea bujiilor incandescente rupte fără a fi necesar dezmontarea chiuloasei de pe motor. Unversal, este ideal pentru motoare Mercedes-Benz CDI. Extrage bujiile incandescente rupte în chiuloasă M8 și M10. Include filete de 1/4" M8 și M10 și burghiu în trepte de altă rezistență cu dublă dimensiune M8 și M10.

CLESTE CONECTORI BUJII INCANDESCENTE

52816	0,27	6	36
22,80€	Kg		



ÎN UNGHI
DE 235mm

52817	0,28	6	36
21,40€	Kg		

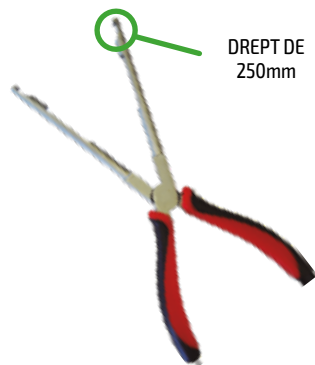

DREPT DE
250mm

Clești utili pentru extragerea conectorilor în radiatoarele Diesel. Cu conectorii localizați în locurile greu accesibile, cleștii permit realizarea operației fără riscul de a dăuna radiatorului sau alte părți ale vehiculului. Mână de gumă ergonomică. În timpul substituirii pompei de injecție, filtre sau alte părți, evitați înapoierea combustibilului în depozit.

SET PENTRU EXTRAGEREA VÂRFULUI DE LA BUJII INCANDESCENTE

52815			
144,00€			
Kg	1		
	5		
	240		



Dispozitiv creat special pentru extragerea vârfurilor de electrod ale radiatorului în caz de rupere în timpul extragerii. Ușurează extragerea fără a fi nevoie de a ridica chiulasa.

SET PREZOANE ANTIFURT PENTRU BMW



53208	1	5	20	22
108,05€	Kg			PCS



SET PREZOANE ANTIFURT PENTRU VW



53207			
86,95€			
Kg	1,65		
	5		
	10		

22
PCS



b51 / 6pt	b57 / 12pt	abc0 / 10pt	abc6 / 17pt
b52 / 7pt	b58 / 13pt	abc1 / 11pt	abc7 / 19pt
b53 / 8pt	b59 / 14pt	abc2 / 13pt	abc8 / 20pt
b54 / 9pt	b60 / 15pt	abc3 / 14pt	abc9 / 21pt
b55 / 10pt	b61 / 16pt	abc4 / 15pt	
b56 / 11pt	b62 / 17pt	abc5 / 16pt	

SET PREZOANE ANTIFURT PENTRU MERCEDES



53328	0,60	5	20	12 PCS
91,95€	Kg			

5A
5C
5D
5F
5G
5L
5N
5P
5X
5E



TRUSĂ TUBULARE STRIATE PT. ȘURBURI UZATE ȘI ANTIFURT

52962	0,72	20	1.500		3/8"
88,00€	Kg				

6, 8, 10, 11,
12, 13, 14,
15, 16, 17,
19mm



TRUSĂ TUBULARE STRIATE PT. ȘURBURI UZATE ȘI ANTIFURT

51998	0,69	20	360		3/8"
80,80€	Kg				

10, 11, 12, 13, 14, 15, 16, 17, 19mm



TRUSĂ DE TUBULARE STRIATE DE 1/2" PENTRU ȘURBURI UZATE ȘI ANTIFURT

52153	0,93	20	300		1/2"
67,00€	Kg				

17, 19, 21, 23, 27mm



EXTRACTOR BOBINE DE INDUCȚIE PENTRU VW

51495	0,96	20	200
47,50€	Kg		



Scoaterea sau instalarea bobinelor de aprindere la motoare de injecție VW CYL 8 și 12.

Scoaterea sau instalarea bobinelor de aprindere la motoare de injecție de 5 și 6 CYL, VW GOLF, BORA, 4 și 5 CYL. VW Passat, 6 CYL, Sharan VW, Touareg, Phaeton.

Scoaterea sau instalarea bobinelor de aprindere de potențial VW Polo, Golf 1.4, 1.6i, 1.4i CADDY, BORA 1.4, 1.6i Phaeton, Passat, Touran 1.6i, Transporter T4.

SET PREZOANE ANTIFURT PENTRU VAG

52823	1	20
153,90€	Kg	

Set special creat pentru a extrage șuruburile de siguranță din jantele vehiculelor Volkswagen.

Practice acoperă 100% din flota vehiculelor VW de pe piață.



EXTRACTOARE



EXTRACTOR DE ȘURUBURI RUPTE

51496	0,09	25	100	2.000
8,00€	Kg	5x6	1x1	1x1

Nº 11/8" - 1/4" (M 3-6) Nº 47/16" - 9/16" (M 11-14)
 Nº 21/4" - 5/16" (M 6-8) Nº 59/16" - 3/4" (M 14-18)
 Nº 35/16" - 7/16" (M 8-11)



EXTRACTOR DE ȘURUBURI RUPTE

51997	0,52	-	20	600
44,20€	Kg	5x6	1x1	1x1

Bază 12 mm : Dimensiuni:
 3, 4, 5, 5.5, 6, 9, 10 mm 1/8", 3/16", 1/4", 3/8"
 Bază 16 mm : Dimensiuni: 11, 12, 14mm, 1/2"



SET EXTRACTOARE ȘURUB PREZOANE RUPTE

52833	0,82	5	10
39,30€	Kg	5x6	1x1

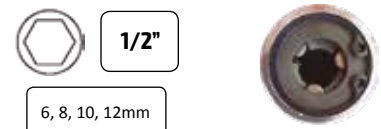

1/2"

6, 8, 10, 12mm



SET PENTRU BERCUIT CONDUCTE FRÂNĂ

52700	0,93	6	12	384
18,00€	Kg	5x6	1x1	1x1

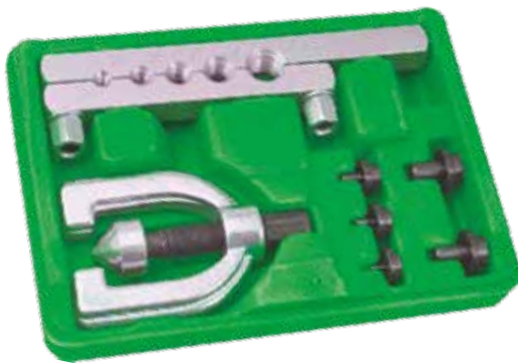

SET PREZOANE ANTIFURT PENTRU BMW

52802	0,62	20
37,80€	Kg	1x1

Se folosește pentru a scoate șuruburile de securitate.
 10 unități de diferite mărimi



10 PCS

30/13 PT, 31/15 PT,
 32/16 PT, 33/17 PT,
 34/18 PT, 35/19PT,
 36/20 PT, 37/21 PT,
 38/22 PT, 40/23 PT



TRUSĂ DE TUBULARE ARTICULATE PENTRU BUJII

52691	0,79	24	480
48,80€	Kg	1x1	1x1

6, 8, 10, 11, 12, 13,
 14, 16mm



82mm

CU SISTEM MECANIC MANUAL



3/8"



CHEIE MAGNETIZATĂ PENTRU BUJIE

52317	0,39	12	72	2.880
18,30€	Kg	5x6	1x1	1x1

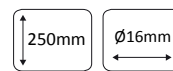

250mm

Ø16mm

52316	0,29	12	72	2.880
17,60€	Kg	5x6	1x1	1x1

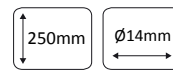

250mm

Ø14mm



TUBULARĂ DE BUJIE HEX.



10054

1,40€

Kg	0,09
5x6	25
1x1	100

16mm



10055

2,10€

Kg	0,14
5x6	25
1x1	100

21mm



CAUCIUC ÎN INTERIOR

LEVIER ARTICULAT PENTRU SLĂBIREA FULIILOR

52961	2,15	8	386
75,70€	Kg	ff	ff



CHEIE PRINDERE FULIE AX CU CAME

52690			
33,30€	1,54	10	280
	Kg	ff	ff

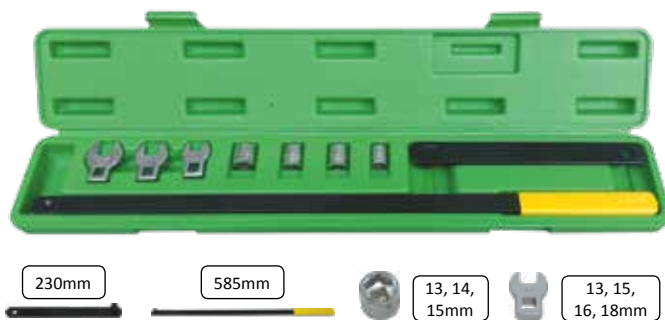

TRUSĂ CHEI CURBATE PENTRU TENSOR CURELE AUXILIARE / 12 FEȚE

52189	2,27	10	120
92,00€	Kg	ff	ff



13, 15, 16, 17, 19mm



TRUSĂ CHEI CURBATE PENTRU TENSOR CURELE AUXILIARE / 12 FEȚE

52832	1,35	10	160
58,30€	Kg	ff	ff



12, 13, 14, 15, 16, 17, 18, 19mm



CAP
INTERSCHIMBABIL

EXTRACTOR PENTRU PREZOANE

51414	0,59	40	1.440
12,00€	Kg	ff	ff



Ø Max: 20mm Ø Min: 15mm

EXTRACTOR PENTRU ARTICULAȚII AXIALE

51368	0,41	50	1.000
42,20€	Kg	ff	ff



Ø Max: 42mm Ø Min: 33mm

DISPOZITIV DEMONTAT / MONTAT AX PLANETAR

51369	0,55	6	36
36,00€	Kg	ff	ff



Ø Max: 42mm Ø Min: 35mm

EXTRACTOR PENTRU BRAȚUL STERGĂTORULUI DE PARBRIZ

52454	0,20	12	36	576
18,00€	Kg	ff	ff	ff



Ø Max: 45mm Ø Min: 17mm

TRUSĂ CHEI PENTRU ALTERNATOR

52293	3,11	5	130
98,00€	Kg	ff	ff

**30
PCS**

1/2" T50 c/33 dinți 19mmX33T - 110mmL
1/2" M10 c/33 dinți 19mmX33T - 110mmL
H15x33 dinți 15mmx33T - 30mmL
H22x33 dinți 22mmx33T - 30mmL
H22 H22 - 30mmL
H17x4 Pini speciali H17x4Pin - 30mmL
1/2"Dr. xH10Bit adaptor
H8 xH10 Vârf 75mmL
H10xH10 Vârf 75mmL
M8xH10 Vârf 75mmL
M10xH10 Vârf 75mmL
T40 xH10 Vârf 75mmL
T50xH10 Vârf 75mmL
M10XH12 Vârf 64mmL
Special H22xH28 - 30mmL

Special H19xH28 - 30mmL
1/2"Dr.XM10 Vârf M10 - 140mmL
3/8":Dr.xM10 c/31 dinți 14mmx31T-85mmL
Special H21xH28 - 30mmL
Special H17 - 35mmL
Special H38x3Pins-20mmL
Special 15mmx33T- 30mmL
H10xFH10 x6L 68mmL
T50XH12 Biț 64mmL
Special H 17 x H 21-30mmL
Special H15xH28 - 30mmL
3/8" Adaptor x10mm
1/2"Dr.XT50 Vârf T50 140mmL
1/2"Dr.XT50 Vârf T50 200mmL
1/2"Dr.XM10 Vârf T50 200mmL



TRUSĂ CHEI PENTRU ALTERNATOR 18 PIESE

51259	2,10	5	150	18 PCS
48,00€	Kg			



PIESE DISPONIBILE

10494 5,30€	10495 2,20€	10496 2,20€	10497 2,20€
CAPĂT CU PRELUNGITOR 14cm	CAPĂT H10	CAPĂT H8	CAPĂT M10
10498 2,20€	10499 2,20€	10500 2,20€	10502 3,10€
CAPĂT M8	CAPĂT T40	CAPĂT T50	TUBULARĂ M10 TORX
10501 8,30€	10485 9,30€	10486 9,30€	
TUBULARE CAPĂT XZN M10 90mm	TUBULARE CAPĂT XZN M10 110mm	TUBULARE CAPĂT TORX T50 110mm	

3 x Tubulare combinate:
T50x113mm, M10x113mm, M10x90mm
1 x Tubulară dințată: M10x140mm
2 x Adaptoare hexag. 19 y 22mm
3 x Tubulare hexagonale: 22x28mm, 19x28mm, 21x28mm

1 x Adaptor Hex. 1/2" x 10mm
1 Vârf M10x12x64L
6 x Vârfuri 10mm (vasos hex.) x 75mm
Dimensiuni: T40, T50, M8, M10, H8, H10

EXTRACTOR CU PRINDERE PRIN FILET

52624	1,26	10	360
15,00€	Kg		



Pentru extragerea de fulii, flanșe, volane și pinoane.
Material: oțel carbon
Ø găuri: 35-85mm
Filet central cu pivot flotant și extraibil
2 x șuruburi 5/16" de 4"

2 x șuruburi 1/4" de 3"
3 x șuruburi 1/4" de 2"
3 x șuruburi 5/16" de 2"
1 x 5" șurub de presiune din aliaj de aluminiu
1 x vârf rotativ 3/4"

EXTRACTOR FULII PROFIL V

51139			
166,30€			
	3,10		
		5	
			200



x3 Conuri de 17mm, 30mm y 55mm
x1 Șurub central de 105x17mm
x1 Prelungitor de 22mm
x1 Set de gheare de 72mm
x1 Șină de 150 mm cu prindere de 60 mm
x1 Șină de 232 mm, cu prindere de 132 mm

Vârfuri:
x2 Șuruburi de prindere M10xP1, 5x30L
x2 Șuruburi de prindere M10xP1, 5x50L

CHEIE AMBREIAJ SPECIALĂ FIAT

52190	0,39	10	1.000
8,00€	Kg		

220 x110mm

Facilitează accesul la tija furcii pentru extracția sa și posteroara înlocuire a discului.
Filet: 1,5cm de lung x 0,5 diam.
Specificații: Util pentru demontarea furcii de ambreiaj de Fiat Ducato.
Dimensiune: 220x110mm



CÂRLIGE PENTRU EXTRAGEREA GARNITURILOR

53053	0,21	10	50	1.000
8,50€	Kg			

1x15,5cm, 1x16,5cm, 1x12cm



EXTRACTOR FULII CU CANAL

51500	1,55	5	640
39,00€	Kg		

40-160mm



Apt pentru utilizarea în arbori cotiți, alternatoare, unități de AACC și pompe de apă.
Brațurile scurte permit un acces ușor în zone dificile.
Desenat pentru extracția arborelui cotit înțepenit și scripetelor auxiliare.
Rang: 40-160mm

TRUSĂ DE 12 PIESE MONTAT / DEMONTAT AIRBAG

51501	0,88	20	240	12 PCS
39,00€	Kg			



Vârfuri 0.5 PC 1/4" x 87 mm (L) :
 2 - Torx :
 T25 (pentru BMW)
 T30 (pentru Audi, Opel, Renault, VW)
 2 - Torx (inviolabil) :
 T25H (pentru BMW)
 T30H (pentru AUDI, BMW, Mercedes, Opel)
 1 - Hex : 5 mm (pentru AUDI)

0.7 PC Cheie extracție :
 1 - pentru Airbag conducător. 1999-04 tip de caroserie de VW Passat, JETTA, GOLF
 2 - pentru VW Passat B5, POLO, LUPO ; AUDI A4, A6, Skoda Superb.
 2 - pentru VW GOLF 4, New Beetle, SEAT, SKODA FABIA, AB Oktavia BJ.99
 1 - pentru VW GOLF 4 (BJ, 1998-2004), VW PASSAT BJ.1997 AB, AB BORA BJ.1999
 1 - pentru U.A VW- MODEL: AB PASSAT BJ.2000

PÂRGHIE PENTRU EXTRAGEREA BRAȚELOR DE SUSPENSIIE

51902	5,26	1	46
59,00€	Kg		

Lungime: 120 cm
 Diam. Tub: 3, 5 cm
 Distanță de ancoraj: 50, 45, 40, 35, 30 cm
 Ancoră de 15x13 cm

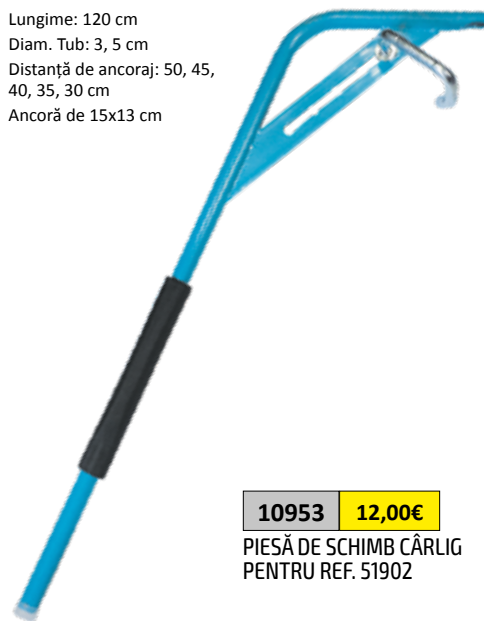

10953 **12,00€**
 PIEȘĂ DE SCHIMB CÂRLIG
 PENTRU REF. 51902

ALINEATOR DE DIRECȚIE

51991	1,15	10	120
34,00€	Kg		

Lungime totală deschis 1950mm
 Lungime totală închis 1100mm
 Dimensiunea șurubului M6x15mm
 Tub exterior de 20x20 din aluminiu
 Tub inferior de 16x16 din fier zincat

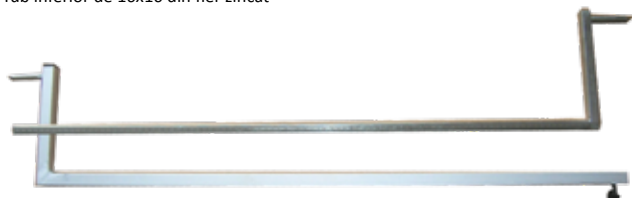

VERIFICATOR MECANIC DE PIVOȚI (ROTULE)

52541	2	10	120
32,00€	Kg		

Pentru a depista jocul in rulmenți, bușe, rulmenți de roată, articulații axiale, stabilizatori, etc.



SET DE 5 EXTRACTOARE DE PIVOȚI (ROTULE)

51123	5,29	4	60
127,00€	Kg		

Set de 5 extractoare versatile. Permite extracția ușoară a celor mai tradiționale tipuri de articulații de pivoți.

Tipul de separator de la junta presei permite retragerea jantei presei fără a strica încălțătoarele și alte piese de alt tip ce alte extractoare pot provoca.



EXTRACTOR ARTICULAȚII SFERICE HIDRAULIC

N

53384	7,30	2	62
130,35€	Kg		



Deschiderea: 100mm
 Lățimea: 35mm



EXTRACTOR UNIVERSAL DE PIVOȚI

52642	1,28	5	10
20,60€	Kg	5x6	ff

Ø 20mm

Deschidere Max: 60mm



2 DIMENSIUNI AJUSTABILE:
55 ȘI 60mm

EXTRACTOR ARTICULAȚII SFERICE HEAVY DUTY

52698	1,27	5	20	720
24,00€	Kg	5x6	ff	

Ø 17-22mm

Deschidere: 20-50mm



EXTRACTOR ARTICULAȚII SFERICE

52699	0,77	10	30	1.050
15,20€	Kg	5x6	ff	

Ø 18-22mm

Deschidere:
15-50mm



SET EXTRACTOARE PENTRU PIVOȚI (ROTULE)

51490	1,88	10	300
28,00€	Kg	ff	

Conține:

1 Mâner detașabil +
3 furci : 11/16, 15/16 și
1-1/8.

Furci făcute din oțel forjat
(chrom Vanadium) de mare
rezistență.

Amândouă mâner
sunt înlocuibile.

1 Mâner desenat pentru
a se putea utiliza cu pistol
pneumatic.



EXTRACTOR DE RULMENȚI CU PRINDERE INTERIOARĂ

51124	3,29	5	20	120
161,90€	Kg	5x6	ff	

Conține : Extractor Universal

Adaptor de 3/8" la 1/2" (10-14 mm)

Adaptor de 9/16" la 11/16" (15-19 mm)

Adaptor de 5/8" la 1" (18-25 mm)

Adaptor de 1" la 1 1/4" (25-32 mm)

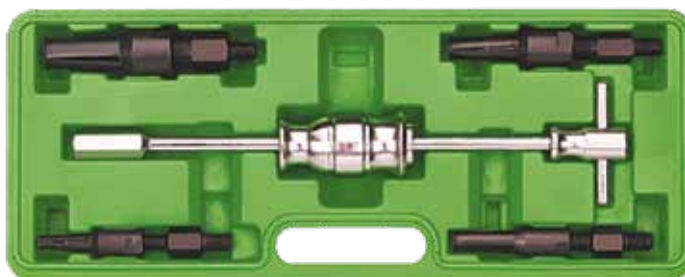

EXTRACTOR DE RULMENȚI CU 3 SETURI DE GHEARE

51122			
141,00€	Kg	4,5	
	ff	5	
			120

Conținut:

Bară centrală + Prezon

Gheare mici

Gheare mijlocii

Gheare lungi

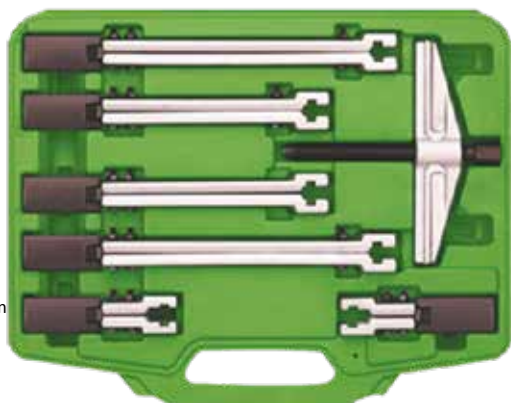

11492

36,50€

115 - 60mm

11493

39,00€

230- 170mm

11494

42,30€

280- 220mm



13679 5,75€

VÂRF GHEARĂ P/51122



Min: 30mm
Max: 130mm

SET EXTRACTOARE GHILOTINĂ

51125	4,73	5	160
68,00€	Kg	ff	

Capacitatea ghihotinelor :

Set Inch : 1/4", cu 30 mm și
50 mm

Șurub de 3/8" de 9.5x125
- 24 UNF

Cap de 3/8" x 16 UNC

Set 2 Inch : 1/4" - 3 1/2", cu
50 x 75 mm

Șurub de 1/2" de 12.7x135
- 20 UNF

Cap de 3/8" x 16 UNC



GHILOTINĂ PENTRU EXTRACTOARE DE RULMENȚI

52626	2,5	5	800
31,20€	Kg	ff	

75 - 105mm

52627	5,27	2	231
67,80€	Kg	ff	

105 - 150mm

Pentru extragerea rulmenților și
pinioanelor de la mașini și autovehi-
cule comerciale ușoare.

Extrage ușor cutii de viteze,
scripete și volane.



EXTRACTOR DE RULMENȚI CU SFERE FALSE

53062

132,00€

Kg 2,41

Sub 10

ff 180

5, 6, 8, 9,
11, 12, 5mm

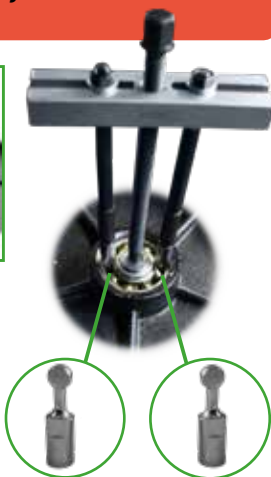

EXPOZANT EXTRACTOARE

53146

22,00€

Kg 0,70

Sub 5

ff 10

ff 200



EXTRACTOR NU ESTE INCLUS

EXTRACTOARE CU 2 GHEARE

52727	0,2	5	96	1.152
27,00€	Kg	Sub	ff	ff

25 - 70mm



50mm

52728	1,23	5	500
57,80€	Kg	ff	ff

25 - 130mm



110mm

52729	3,4	6	240
138,70€	Kg	ff	ff

60 - 200mm



160mm

52730	8,64	2	72
309,90€	Kg	ff	ff

80 - 350mm



225mm



52727



52728

52729

52730

EXTRACTOARE CU 3 GHEARE

52731

34,00€

Kg 1,08

Sub 4

ff 24

ff 576

50 - 100mm

52732

61,00€

Kg 2,53

Sub 4

ff 12

ff 72

70 - 150mm

52733

115,00€

Kg 5,19

Sub 4

ff 4

ff 72

95 - 200mm

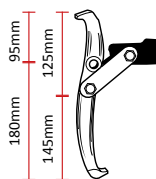

52731

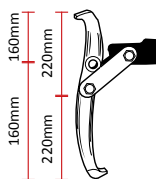

52732

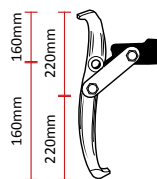

52733



EXTRACTOARE CU 3 GHEARE CONVERTIBILE ÎN 2 REVERSIBIL

52010

48,40€

0,48

Kg 4

Sub 40

ff 360

52010 **2T**

Dimensiunea ghearei: 90mm

Dimensiune pin: 124mm

Unghie prindere: 12mm

Lățimea crucei: 66mm

52296 **5T**

Dimensiunea ghearei: 132mm

Dimensiune pin: 217mm

Unghie prindere: 14mm

Lățimea crucei: 95mm

52296

75,80€

1,57

Kg 4

Sub 8

ff 120

52297

111,00€

3,33

Kg 6

ff 48

52298 SCURTĂ ȘI LUNGĂ

Dimensiunea ghearei:

scurtă 134mm, lungă 207mm

Dimensiune pin: 218mm

Unghie prindere:

scurtă 13mm, lungă 15mm

Lățimea crucei: 95mm

52297 **7T**

Unghie prindere: 15mm

Lățimea crucei: 152mm

Dimensiunea ghearei: 210mm

Dimensiune pin: 313mm

52298

146,90€

2,65

Kg 6

ff 396



SET DE 19 EXTRACTOARE DE PAPUCI ELECTRICI

N

53391	-	-	10	-	19 PCS
58,40€	Kg	5.6	11	1.1	



A, B, C, D, E, F, G, H, I, J, K, L, A1, B2, C3, D4, E5, F6, G7

SET DE 23 EXTRACTOARE DE PAPUCI ELECTRICI

N

53393	-	-	5	-	23 PCS
98,20€	Kg	5.6	11	1.1	



BMW, Audi, Volkswagen, Mercedes, Opel, Porsche, Jaguar, Saab, Seat, Ford, Skoda, Renault, Citroën, Chrysler, Fiat, Honda, Mazda, Mitsubishi, Toyota

PRESĂ BUCȘE PENTRU VAG

52270	3,18	4	96	99,90€
	Kg	11	1.1	

Conține:

Ax, Prelungitor de ax,
Piuliță de împingere
M10x1.25,
Cap adaptor din oțel carbon,
Separator,
Piesă de presiune,
Mandrină de centrare din
aliaj de aluminiu



SET DE 52 PIESE PENTRU EXTRAGEREA APARATELOR RADIO

N

53388	1,5	5	120	52 PCS
80,10€	Kg	5.6	1.1	



Blaupunkt, Clarion, Skoda, BMW, Audi, Grundig, JVC, Pioneer, Volkswagen, Mercedes, Opel Doppel-Kugel-Inbus, Porsche, Becker, Kenwood, Sony, Panasonic, Fiat Brava, Ford.

RUSĂ DE ACCESORII PENTRU DEMONTAT APARATE RADIO

51126	0,2	10	100	1.320	27,00€
	Kg	5.6	1.1	1.1	



Blaupunkt, Peugeot, Clarion, Skoda, Alpine, BMW, Opel, Audi, Grundig VDO, JVC, Pioneer, Volkswagen, Mercedes, Porsche, Renault, Becker

PRESĂ PENTRU EXTRAS ȘI MONTAT BUCȘE PENTRU VAG

52432	1,32	10	300	28,00€
	Kg	11	1.1	

Util pentru Volkswagen Polo model 2002
Facilitează schimbarea bucșelor din cauciuc
de la brațele de suspensie din față.



SET DE TUBULARE CU CRENELURI EXTERIOR

52834	3,73	5	1.500
194,40€			

Set de tubulare pentru extragerea de piulițe crestate în vehicule industriale.

1/2"

22x3, 26x3,5, 30x4, 33x4,
37x4,5, 44x5, 50x5,5,
56x5,5, 63x6, 69x6,5x
75x6,5



SET DE TUBULARE CU CRENELURI ÎNLĂNȚUITE

52835	5,20	3	1.500
212,20€			

Set de tubulare pentru extragerea de piulițe crestate în vehicule industriale.

1/2"

26x5,3, 1,2x6,25,
34,2x6,3, 38,2x6,65,
42,2x7,3, 50,1x8,25,
58,2x9,8, 74,6x11,9,
82,2x13,25, 87,7x13



PRESĂ UNIVERSALĂ PENTRU EXTRAS/ MONTAT BUCȘE ȘI RULMENȚI SUSPENSIE

52494	
189,00€	
	18,55
	1
	34



Utol pentru instalarea și deinstalarea bușelor și rulmenților de suspensie. Conține furtune de diferite dimensiuni și diferite țije filetate metrice.

Dimensiuni: M10, M12, M14, M16, M18

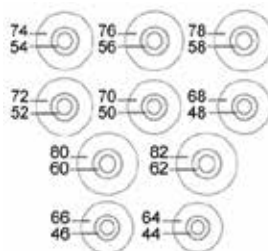

12926	17,50€	M10
12927	18,40€	M12
12928	19,30€	M14
12929	20,50€	M16
12930	22,10€	M18

JOC DE MONTAJ PENTRU RULMENȚI

53058	
154,00€	
	8,19
	1
	100

220mm

∅ 12mm

∅ 18, 19, 20, 21, 22,
23, 24, 25, 26, 27,
28, 29, 30, 31, 32,
33, 34, 35, 36, 37,
38, 39, 40, 41, 42,
43, 44, 45, 46, 47,
48, 49, 50, 51, 52,
53, 54, 55, 56, 57,
58, 59, 60, 61, 62,
63, 64, 65, 74mm



JOC DE EXTRAGERE ȘI INSTALARE A RULMENȚILOR

53056	
99,00€	
	8,33
	2
	70

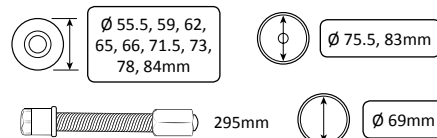

EXTRACTOARE

TRUSĂ ADAPTOARE PENTRU MONTAT RULMENȚI

51349	1	10	180
27,50€			

Adaptoare cu tijă pentru întreținerea piuliței striate.

Apt pentru toate tipurile de bujii și rulmenți

Dimensiuni: de la 10mm până la 42mm

42 - 38mm, 40 - 35mm,
36 - 32mm, 30 - 28mm,
24 - 22mm 27 - 25mm,
18 - 16mm, 20 - 18mm,
22 - 20mm, 12 - 10mm,
14 - 12mm, 16 - 14mm,
17 - 15mm



JOC PENTRU INSTALAREA RULMENȚILOR ȘI GARNITURILOR DE ETANȘEITATE

53059			
42,00€		1,56	
		10	
		240	

∅
39,5, 44,5, 50,
59, 63, 65, 72,
76, 81mm



TRUSĂ PENTRU MONTAT / DEMONTAT RULMENȚI

52551	10,42	2	70
128,70€			

Axuri de transmisie: 32 și 38mm

Dimensiuni discuri:

50, 55, 60, 64, 67, 70, 72, 74, 75,
78, 82, 84 și 88mm

Șurub reforțat pentru utilizarea cu instrumente de impact. Ax din oțel-fosfat pentru a preveni coroziunea. Adecvat pentru demontarea și instalarea de rulmenți industriali.



EXTRACTOR CU PRINDERE PRIN FILET

51140	1,02	24	290
62,70€			

Este un extractor universal cu prindere prin filet și pătrat de susținere împotriva rotirii.

Permite reglarea axei centrale atunci când este cuplat. Folosind bara de șurub centrat pentru a deșurubă din rolă. Șuruburi de fixare: M6, M8.



INSTALATOR REGLABIL CU SIGILIU 18-90MM

53129			
56,00€		0,96	
		2	
		10	
		180	

18-90mm



EXTRACTOR PENTRU HOMOCINETICĂ DE PLANETARE

51364	2	5	280
84,00€			

∅ Max: 31mm

140 - 240mm



EXTRACTOR DE BUCȘE CU SCOABĂ SPECIALĂ

REF.	3,85	4	295
162,50€			

Acest extractor include 4 șaibe conice de extracție.
P.C.D. rang 96-126 mm



51231 x4

51138 x5

SET DE 3 TUBULARE PENTAGONALE

51996	0,40	10	40	960
18,00€	Kg			



DISPOZITIV DE MĂRIRE ȚEAVĂ EȘAPAMENT

52637	
40,20€	

	3,01
	5
	200

1-1/8" - 1-3/4"
1-1/2" - 2-1/2"
2-1/8" - 3-1/2"



UNEALTĂ PENTRU TEVI DE EȘAPAMENT VĂG

52947	0,44	36	1.008
16,20€	Kg		

Lung: 6 "(150mm)
A se folosi cu cheie de 17 mm.
Distanța minimă: 45 mm (de DO)
Distanța maximă: 80 mm (de DO)
Aplicații: VW, Audi, Golf,
Jetta, Passat



Esențial pentru extragerea sigură a colierelor de fixare de eșapament la colector.
Elimină și înlocuiește colierul arc de eșapament al primelor modele de Volkswagen echipate cu apă de 4 cilindri răcit pe motoare.

PRESĂ P/DEMONTAT ȚEVI DE EȘAPAMENT

51999	4,93	4	120
75,60€	Kg		

Apertura: Min. 50mm Max. 70mm
Recorrido de enganche: 170mm
Contiene 4 adaptadores estridados



SET DE 2 CÂRLIGE PENTRU A EXTRAGE ÎN ȚEAVA DE EȘAPAMENT

52849	0,22	10	40	480
6,00€	Kg			

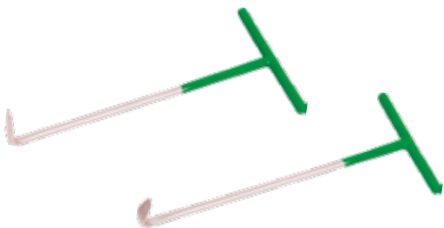

SET DE 3 LEVIERE CU CAP REGLABIL

51990	1,83	10	320
85,90€	Kg		

Levier de: 19,5 cm,
Levier de: 24 cm
Levier de: 32 cm
Lungimea cârligului: 6 cm
Lățimea cârligului: 1,5 cm
Rang de rotație: de la 0° până
la 230°



CHEIE DINAMOMETRICĂ CU HEDER INTERSCHIMBABIL 200NM

52913	3,94	4	128
272,60€	Kg		

1/2"

- Cuplu de strângere 40 -200Nm
- Hedere incluse :
Chei 13, 14, 15, 17, 19, 22, 24, 27, 30MM
- Heder pentru clichet de 1/2"
- Hedere diferite, disponibile și separat.



18x14mm

325mm

CHEIE DINAMOMETRICĂ CU VIZOR

53081	1,08	25	200					1/4"	4-20NM (36T)	
98,00€	Kg									
53082	1,85	4	8	204					1/2"	40-210NM (24T)
116,00€	Kg									



CHEIE DINAMOMETRICĂ DIGITALĂ

51828	2,31	6	120					1/2"
444,00€	Kg							



UNITĂȚI DE
MĂSURĂ:
Grade
In-Lb
N-m
Ft-Lb

Exactitate	CW: +/- 2% ccw: +/- 3%
Precizie în grade	+/- 2°
Rang de operație	340 N-m / 250,7 ft-lb / 3.009 in-lb / 3.469kg-cm / 999°
Rezoluție	0,1 cN-m / 0,1 ft-lb / 1 in-lb / 1Kg-cm / 1°
Arhivă de măsurări	9
Leduri	2 Led (2 rojo + 10 verde)
Operativitate	Peak hold / Track
Unități de selecție	N-m, in-lb, ft-lb, kg-cm, Grados
Lung	650mm
Dinți	36
Pătrat	1/2"
Butoane	5
Baterie Tip	AAx2
Baterie uz continuu	110h
Baterie uz standby	1 año
Rang de temperatură de uz	-10°C ~ 60°C
Rang temperatură înmagazinare	-20°C ~ 70°C
Umiditate	Până la 90% fără condensare
Viață utilă	10.000 cicluri

CHEI DINAMOMETRICE

51262	0,83	4	16	384					2-24 Nm 0.2 - 21.4 M.Kg	1/4"	270mm
40,00€	Kg										
51127	1,73	4	8	240					28-210 Nm 2.9 - 21.4 M. Kg	1/2"	470mm
42,00€	Kg										
51338	1,09	4	16	300					19-110 Nm 1.9 - 11 M. Kg	3/8"	365mm
41,00€	Kg										



52250	8,40	2	48					140-980 Nm 14 - 100 Kg	3/4"	1.230mm
480,00€	Kg									



ȘURUBELNIȚĂ DINAMOMETRICĂ

DIGITAL

51829	0,65	12				
390,30€	Kg					

MECANICĂ

51830	1	12	300				
76,50€	Kg						



	51829	51830
Exactitate	CW: +/- 2,5% ccw: +/- 3,5%	CW: +/- 4%
Precizie în grade	+/- 2°	-
Rang de operație	10 ~ 200 cN-m	2 ~ 10 Nm
Rang de operație mixtă	40 ~ 200 cN-m	-
Rezoluție	0,1 cN-m / 1 in-lb / 1Kg-cm	-
Arhivă de măsurări	9	-
Leduri	2 Led (1 rojo + 1 verde)	-
Unități de selecție	N-m, in-lb, kg-cm	N-m, in-lb
Lung	200mm	242mm
Dinți	-	-
Pătrat	1/4"	1/4"
Butoane	5	-
Baterie Tip	AAx2	-
Baterie uz continuu	110h	-
Baterie uz standby	1 año	-
Rang de temperatură de uz	-10°C ~ 60°C	-
Rang de temperatură înmagazinare	-20°C ~ 70°C	-
Umiditate	Până la 90% fără condensare	-
Viață utilă	10.000 ciclos	100.000 cicluri

SISTEM DE ADÂNCIME DIGITAL

53042	0,83	25	100	1.500
10,50€	Kg	sub	ff	

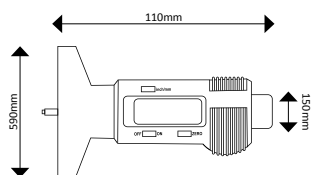

MICROMETRU DE ADÂNCIME

52873	0,04	50	300	1.500
8,75€	Kg	sub	ff	

0-40mm



GONIOMETRU 1/2"

52583	0,19	12	48	864
8,90€	Kg	sub	ff	



MICROMETRU DE ADÂNCIME CU SUPOR MAGNETIC

52904	2
43,80€	10
	160

Medición: 0-10mm
Calibrado: 0,01mm
Esfera: 58mm
Base magnética: 40kg



13704 16,00€

MICROMETRU DE ADÂNCIME PENTRU REF. 52904

GONIOMETRU DE 3/4"

52793	0,72	6	12	1.500
70,50€	Kg	sub	ff	

Folositor pentru strângerea în grade a șuruburilor depinzând de specificațiile determinate de către fabricanții vehiculelor și utilajelor..

Strângere realizată prin intermediul clichetului sau cheii dinamometrice de 1/2". Vizor transparent pentru o corectă viziune a măsurării. Nivelul de măsurare de 0 a 360°.

Cheie în formă de „L”, pentru a ușura o fixare corectă a sculei pentru o măsurare posterioară exactă..



GONIOMETRU DE 1/2" MAGNETIZAT

52794	0,33	6	24	1.500
29,30€	Kg	sub	ff	

Folositor pentru strângerea în grade a șuruburilor depinzând de specificațiile determinate de către fabricanții vehiculelor și utilajelor.. Strângere realizată prin intermediul clichetului sau cheii dinamometrice de 1/2"

Vizor transparent pentru o corectă viziune a măsurării. Nivelul de măsurare de 0 a 360°. Fixarea goniometerului prin intermediul brațului magnetizat pentru corecta sa fixare înainte de folosință. Sistemul de magnet permite utilizarea sculei cu rapiditate și de o formă simplă și sigură.



ȘUBLER

50937	0,24	10	50	1.500
9,40€	Kg	sub	ff	



50937

MECANIC

←150mm→



50724	0,24	-	50	900
22,00€	Kg	sub	ff	



50724

DIGITAL

←150mm→



TRUSĂ DE LERE

52433	0,10	10	50	600
5,80€	Kg	sub	ff	

0,05 - 1mm



BANDA METRICA

53025	53026	53027
2,90€	4,90€	6,90€
Kg 0,13	Kg 0,26	Kg 0,40
sub 12	sub 12	sub 12
ff 48	ff 48	ff 48
1.500	1.500	1.500
3M x16mm	5M x25mm	7,5M



MULTIPLICATOR DE FORȚĂ CLICHET DE 3/4" + REDUCTOR DE 1/2"

51958
340,00€
Kg 4,35
ff 4
sub 96



1x Raport de multiplicare
1x Clichet manual
1x Adaptor 1/2" M x 3/4" F
1x Kit eliberare
1x Prelungitor 90°
1x Prelungitor 350 mm

Caracteristice:
Relație de transmisie 1: 4
Relație de multiplicare 1: 3.3
Forță max. de intrare: 303 Nm
Forță max. de ieșire: 1.000 Nm

MULTIPLICATOR DE FORȚĂ JUNIOR

52012
61,20€
Kg 2,34
ff 4
sub 128

1/2"



1x Raport de multiplicare
1x Prelungitor de 90°
Chei tubulare de 17 mm, 19 mm și 21 mm

Raport de multiplicare: 1: 18
Forță max. ieșire: 360 Nm
Forță max. torsiune : 800 Nm

MULTIPLICATOR DE FORȚĂ ARTICULAT

52796	8,88	3	72
85,20€			

Util pentru camioane cu capac și protector de roată.

Unic pe piață.

Adaptare Ușoară la orice vehicul universal.

Util pentru înșurubare și deșurubare

Include: 1x tubulară 1" 32mm + 1x tubulară 1" 33 mm



1:58

MULTIPLICATOR DE FORȚĂ CU PRELUNGITOR

51919	8,05	4	96
58,00€			

Material: 40CR

Maxim cuplu de strângere: 6 000 Nm

Raport de multiplicare 1:56

Include tubulare de 32mm și 33mm de 1"



TRUSĂ DE 8 TUBULARE DE IMPACT 1" PENTRU MULTIPLICATOR DE FORȚĂ

52056			
56,90€		5,50	
		4	
		128	

1"	22, 24, 27, 30, 32, 33, 38, 41mm
----	----------------------------------



DISPOZITIV CENTRAT AMBREIAJ

52495	0,20	4	48	864
19,00€				

Pentru majoritatea modelelor de autovehicule de pe piață. Include 3 adaptoare de diferite diametre.



CENTRATOR AMBREIAJE SAC

N

53410			
74,55€		1,60	
		10	
		180	

Diametru de centrare :

15-19 / 20-26,6 / 23-36mm

Accesorii diametru:

12, 14, 15, 16, 17, 18, 19, 20mm



KIT PENTRU REPARAREA AMBREIAJULUI DUBLU PENTRU TRANSMISIA DSG DE VAG

53057	6,04	2
154,00€		

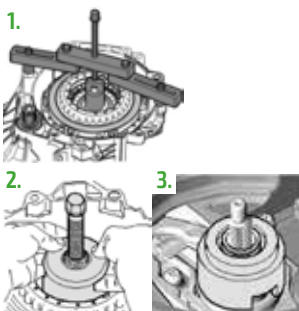

Pentru schimbări servicii DSG Golf (2004), Golf Plus (2005), AUDI A3 (2004), cu 7 trepte de cod transmisii 00, și Touareg (2003-), cu 6 trepte cod de transmisie 08D. OEM referințe utile: T10323, T10373, T10374.

CENTRATOR AMBREIAJE SAC

N

53392	-	-	25	-	2
44,20€					PCS

Ø 20 - 26mm

Ø 15 - 19mm



fără TVA

JBM

WWW.JBMCAMP.COM

JBM
2018

149

SCULE SPECIALE

TRUSĂ PENTRU CENTRAT AMBREIAJE S.A.C.

53001	9,69	1	28
240,00€	Kg		

Se evită deformații de ambreiaj utilizând Pretensorul. Ajută la comprimarea plăcilor de presiune, la demontarea și montarea ambreiajului, la re poziționarea arcului de reglaj și la centrarea supapei cu ghidajul rulmentului.

Adecvat pentru aproape toate ambreiajele SAC (ambreiaj cu reglaj automat).

Folosite pentru următoarele mărci: VW-Audi, BMW, Mercedes, Volvo, Renault, Opel, etc.

• Avantaje:

- Întinderea plăcii de presiune a ambreiajului în montare și demontare
- Repunerea cheii de ajustare cu instrumentul de resetare.
- Centrarea supapei în raport cu ghidajul rulmentului.

• Conținut:

- Pretensor de ambreiaj
- Centrator cu 3 găuri
- Dispozitiv pentru reset
- Set de dispozitive pentru centrare
- Centrator cu 4 găuri



Pentru:
VW
Audi
Bmw
Mercedes
Volvo
Renault
Opel

TESTER PENTRU SISTEMUL DE RĂCIRE

52687	5,72	3	30
298,00€	Kg		

Nivel de comprobare 0 -2,5 bar
19 capete de comprobare ale radiatoarelor specifice
1 capăt de comprobare de radiator universal

1: Pompă de presiune cu supapă de descărcare

2A: conector 1: atașat pentru conectoarele No.3(R123) și No.4 (R124)

2B: conector 2: atașat pentru conectoarele No. 3(R123) și No. 5(R125)

3: Mercedes (W123, W126, W124, W201), GM(Buick), Jeep 4: Peugeot, Subaru, Chrysler, Acura, GM (Nova, Spectrum, Sprint), Mitsubishi, Nissan, Mazda, Toyota, Infiniti, GEO, Suzuki, Isuzu, Mercedes

5: Honda, Toyota, Suzuki, Mitsubishi, Chrysler, Acura 6: Mercedes Benz (ML, W163, W164), GM (Acliva, Skylark, Grand Am 1992~2002)

7: Volvo, Saab, Sterling, Citroen, Renault, Fiat, Alfa, Jeep

8: VW(Vento, T4, Passat-1996, Golf, Beetle, Sharan)

9: Audi(A4, A5, A6), BMW 345, VW(Pas-sat-1997~2002), Porsche(Cayenne)

10: BMW (E46, E36, E34, E39, E38, E32, E90)

11: Audi, VW

12: Internacional, Land Rover, Jaguar

13: Mercedes (C, E, S, W140, W220, W124, W210, W211, W215, W216, W221, R230)

14: Ford Focus

15: Mazda(M3)

16: Mercedes clase A (W168)

17: BMW E60, E63, E64, E65

18: VW SHARAN 1.8T 2.8

19: TOYOTA-RAV4, PREVIA Adaptor universal de gumă pentru purjare și umplere ale radiatoarelor

20: SAAB

21: LAND ROVER



TESTER PENTRU SISTEMUL DE RĂCIRE

51339	5,24	3	30
258,00€	Kg		

N. 1 GM, 4 cilindri (Buick, Chevrolet, Pontiac, Cadillac) N. 2 Camion N. 3 Mercedes-Benz, Ford, Chrysler, GM, Jeep, Peugeot N. 4 Acura, Dodge, Eagle, Geo, Honda, Isuzu, Lexus, Mazda, Mitsubishi, Suzuki, Toyota, Nissan, GM, Peugeot, Ford, Chrysler N. 5 Toyota, Honda, Mitsubishi, Suzuki, Lexus, Chrysler, Acura, Dodge N. 6 Buick, Chevrolet, Ford, Lincoln, GM, Opel, VW, Saab, Benz (clase ML) Jaguar, Rover N. 7 Jeep, Renault, Saab, Volvo, Audi, Citroën, Fiat, Peugeot, Alfa N. 8 VW N. 9 Audi (A4, A6, A8) VW (Passat 1997-2002, Golf, Jetta) N.10 BMW N.11 VW, Audi N.12 Ford, GM, Rover, Opel, Jaguar, BMW 245 N.13 Mercedes-Benz Sedane N.14 Saab, Opel

Adaptor de 2.3"

Adaptor de 4.5"

Pompa de la sistemul de racire
Dopuri pentru sistemul de racire
cu conectori rapizi



SET DE INSTRUMENTE P-U AER CONDIȚIONAT

N

53457	-	10	20	-
21,05€	Kg			

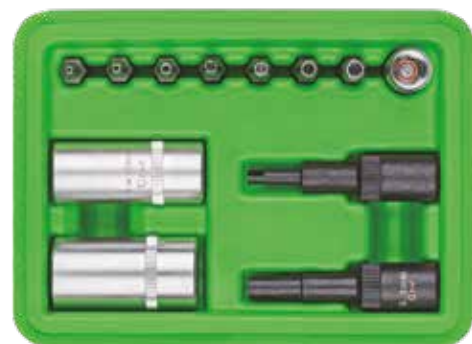

KIT DETECTARE PENTRU SCURGERE A/C

52844	1,08	10	120
79,00€	Kg	ft	ft

Set special creat pentru a detecta repede pierderile de presiune în sistemul de a/c și refrigerare.

Consiste în a introduce un lichid fluorescent neutru în circuit pentru a detecta pierderea de formă rapidă.

Conține:
 -1 X lampă UV
 -1 X pereche de ochelari vision UV
 -3 X baterii „aaa,”
 -1 X seringă pentru lichid
 -1 X adaptor rapid
 -1 X adaptor cu prelungitor



LICHID PENTRU DETECTAREA SCURGERII SISTEMULUI AACC 250 ML

12977	0,33	3	12	384
38,00€	Kg	sub	ft	ft

250ml

O aplicare de 7.5 ml pentru fiecare 1.4l de refrigerant



SET DE COMPROBARE, UMLERE ȘI VID PENTRU SISTEMUL AACC

N

53329	2,80	5	75
81,55€	Kg	ft	ft

PSI

53456	-	5	-
81,55€	Kg	ft	ft

BAR

Încercați variații pe părțile laterale ale sistemelor de înaltă și joasă presiune de aer condiționat ale vehiculului.

Adecvat pentru aplicații R134a și R12.

Ușoare Design bloc din aluminiu, cu vedere de sticlă și care poate fi citit de înaltă anti-vibrații. cuple de servicii profesionale (de culoare-codificate și etichetate).

Trei furtunuri de încărcare, cod de culori și un cârlig agățat pentru a permite utilizarea hands-free.

Aplicație: R134a, R12
 Lungime furtun: 1550mm



LAMPĂ UV MOBILĂ PENTRU ATELIER

N

53451	0,35	10	40
45,05€	Kg	sub	ft

LUMINĂ ULTRAVIOLETĂ



LUMINĂ ULTRAVIOLETĂ



SET P-U DISCONECTAREA AERULUI CONDIȚIONAT

N

53459	-	10
60,40€	Kg	ft



SET P-U DISCONECTAREA TUBURILOR DE AER CONDIȚIONAT

N

53458	-	12	72
3,45€	Kg	sub	ft



AER CONDIȚIONAT

SET DE UMLERE DE ULEI CU PÂLNIE ȘI ADAPTOARE

N

53347	2,75	4	36
84,50€	Kg		

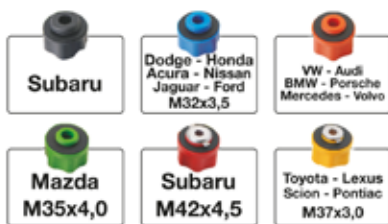

POMPĂ DE PRESIUNE VACUUM ÎN DOUĂ DIRECȚII

51822	1,90	6	84
109,00€	Kg		

Acest kit include, împreună cu pompa de vid, un set complet de vârfuri, adaptoare, capace, elastice și un măsurător pentru o corectă și ușoară revizuire a sistemului de frâni și de asemenea o verificare ușoară a acestuia.



DISPOZITIV MAGNETIC PENTRU REGLAREA UNGHIULUI DE FUGĂ

52318	0,64	24	336
58,40€	Kg		

-6° / +6°



EXTRACTOR DE BRAȚE DE DIRECȚIE

52874	1,20	20	1.500
59,40€	Kg		

Ø 9-20mm

52875	1,27	20	1.500
64,80€	Kg		

Ø 14-23mm



DISPOZITIV PENTRU DEMONTAT BARA DE DIRECȚIE

52640	1,81	4	200
54,60€	Kg		

Ø 28-35mm

52641	2,28	4	200
58,80€	Kg		

Ø 35-45mm



KIT PENTRU BRAȚUL DE DIRECȚIE

52639	5,05	2	76
140,90€	Kg		

Ø 30-35mm
Ø 35-40mm
Ø 40-45mm



PRESĂ HIDRAULICĂ PENTRU ARCURI SAU AMORTIZOARE DE SUSPENSIE

50827

244,00€

32,45

1

18

35T

350 x 350 x 1.100mm

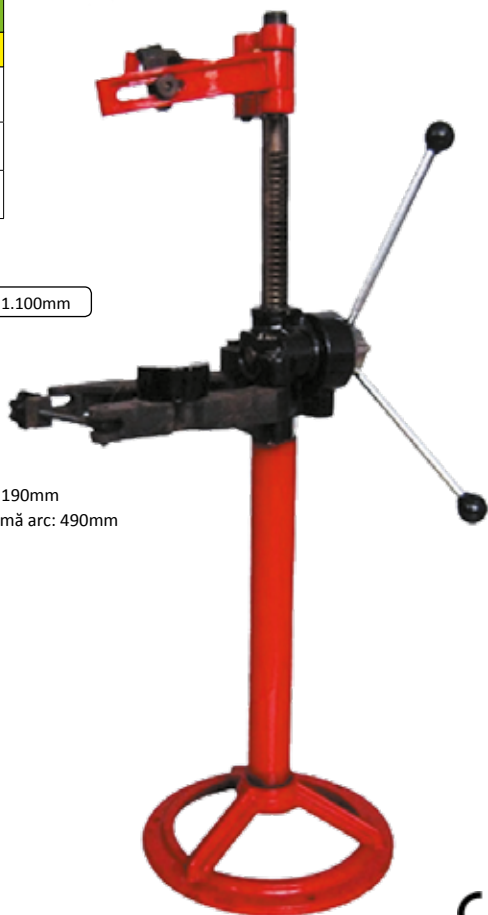

Ø maxim arc: 190mm
Înălțime maximă arc: 490mm
300Psi

CE

TRUSĂ DE COMPRIMAT ARCURI

N

53394

29,2

1

18

Kit profesional care vă permite să îndepărtați și să instalați rapid arcurile de suspensie în față și în spate fără a scoate axul.

519,20€

26.000 Nm
1.050 Kg

300 mm

2 x 65-125MM
2 x 88-160MM
2 x 126-212MM



Bratul telescopic și suprafețele antiderapante care permit o aderență solidă a arcurilor.
Claw-uri echipate cu o protecție plastică interschimbabilă pentru a evita deteriorarea vopselei de anodare împiedică îndoirea arcurilor în timpul comprimării.
Universal, acoperă 90% din parcul auto.
Poate fi folosit atât pentru arcuri drepte cât și conice.
Conținut:
Dispozitiv / piston.
Trei perechi de clești cu capace din plastic.

PRESĂ PENTRU ARCURI DE SUSPENSIE

51121

1,72

4

8

416

34,00€

Gheare și Prezoane forjate din aliaj
Construite din aliaj de fier și carbon (tratați termic)
Indicată pentru utilizarea în spații cât mai reduse, rezistență superioară și siguranță în timpul utilizării.
Deschidere maximă 250mm

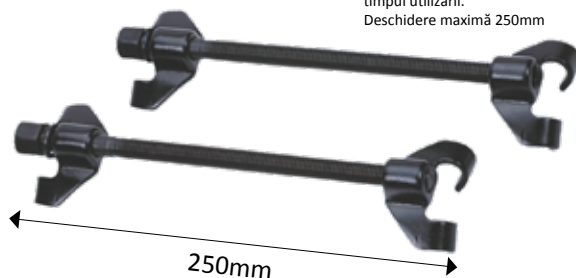

SET PENTRU DEMONTAREA AMORTIZOARELOR

N

53118

6,66

3

42

207,00€

39 PCS

CrV 6140
CrMo SCM415
CrV 50BV30



TRUSĂ COMPRIMAT ARCURI McPHERSON

52227

15,10

1

26

248,00€

Bmw, Toyota, Ford, Mitsubishi, VW, Audi, Saab, Nissan, Honda Accord, Subaru, Volvo, Opel, Porsche



NU UTILIZAȚI
CU AER PISTOL

Capacitate maximă : 2500N. Un corp principal.
Un suport prelungitor. 3 perechi de mandibule.
Perechea 1: Jug de prindere arc: 80-115mm. Greutate: 1,45 kg
Perechea 2: Jug de prindere arc: 110-195mm. Greutate: 2,2 kg
Perechea 3: Jug de prindere arc: 140-195mm. Greutate: 2,3 kg



ȘURUBELNIȚĂ LUNGĂ ÎN UNGHI

51351	0,90	10	320
112,50€	Kg		

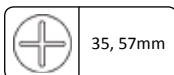
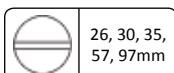
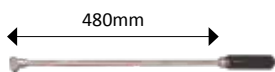

SET DE CHEI PENTRU ARCURI DE SUPAPE

51120	2,42	10	160
38,00€	Kg		

Conține :
Compresor de Arcuri
Adaptor de 30, 25, 23, 19, 16mm

Valabil pentru mașini și motociclete.

Cele 5 adaptoare permit fixarea corectă și ușoară pentru comprimarea arcului de la supapă.



PRESĂ PENTRU ARCURI DE SUPAPE 45-145MM

52734	2,61	10	160
72,20€	Kg		

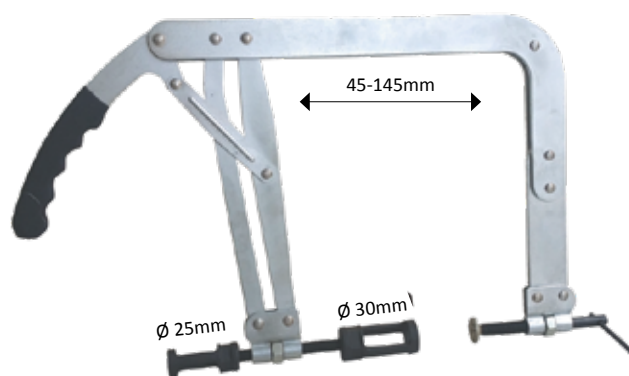

TRUSĂ PENTRU REPARAT FILETE

52294

71,70€

Kg	0,85
	20

**23
PCS**



CONȚINUT:

- | | |
|--|-------------------------|
| 1 Șurub pentru inserție L - 80MM
M18X1.5 | 1 Alezor M18X1.5 - 50MM |
| 5 Piulițe L = 9MM IG = M18X1.5 / AG
= M20X1.5 | 1 Filet M18X1.5 - 50MM |
| | 1 Filet M20X1.5 - 50MM |

PRESĂ PENTRU ARCURI DE SUPAPE

52693

36,70€

0,82	5	25	450
Kg			

Pentru motoare OHV, OHC, CHV
Permite demontarea arcurilor de
supape fără
a fi necesară demontarea
chiuloasei.
Capacitate pentru comprimare
și extracție.

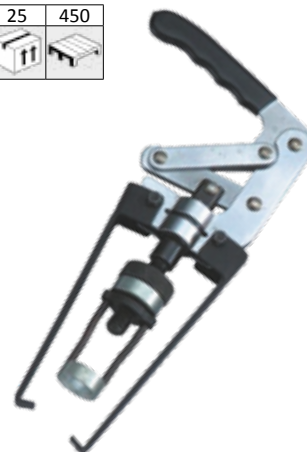

DISPOZITIV PENTRU REPARAREA BORNELOR DE ACUMULATOR

52319	0,16	12	72	720
8,20€	Kg			



52621	0,14	10	40	800
7,10€	Kg			



x2

DISPOZITIV PENTRU MANIPULAT

52613

15,20€

Kg	0,57
	8
	360



APARAT PENTRU DEMONTAREA ȘI NITUIREA LANȘURILOR DE MOTOCICLETE

53055	0,89	10	600
29,00€	Kg	ff	ff



SET DE 3 PERII DE SÂRMĂ

52515	0,15	50	800
9,10€	Kg	ff	ff

225mm



1 x Alamă
1 x Nailon
1 x Oțel

PERIE DE SÂRMĂ

52760	0,09
4,10€	Kg
12	ff
120	ff
2.160	ff



TRUSĂ 38 PERII DE SÂRMĂ ROTUNDE METALICE/PLASTICE

51989	1,64	10	120
40,50€	Kg	ff	ff

**38
PCS**

Ø 8, 9, 10, 11, 12, 13, 14,
15, 16, 17, 18, 19mm

1 Mâner de 1/4" + 1 Prelungitor + 36 perii



CHEIE FIXĂ PENTRU CISTERNĂ COMBUSTIBIL

53096	
38,00€	Kg
1	ff
5	ff
10	ff
270	ff



CHEIE REGLABILĂ PT. POMPĂ COMBUSTIBIL PE REZERVOR

52757	0,55	10	20	360
18,10€	Kg	ff	ff	ff



Min: 80mm
Max: 160mm



CHEI TUBULARE SPECIALE PENTRU MOTOCICLETE

53054	0,16	12	72	1.500
3,30€	Kg	ff	ff	ff



CHEIE PENTRU MOTOCICLETĂ

53086	0,18	12	72	1.500
9,00€	Kg	ff	ff	ff

3/8"



17, 19, 22, 24mm

YAMAHA, KAWASAKI,
BMW, SUZUKI, HONDA



SET DE UNELTE PENTRU CERCURI DE PISTON



53251
80,85€
2,80
4
72



Set complet de arcuri și inele de piston.
Cleşti pentru a instala inele de piston.
Strânsul curelelor are un sistem cu clichet dințat.

COMPRESOR SEGMENTI (CERC) DE PISTON

52696	0,29	10	40	1.040	Ø 53 /175mm
6,80€					3"

52697	0,55	5	40	480	Ø 60 /175mm
9,70€					6"



APARAT ȘLEFUIT CILINDRII DE FRÂNĂ

2 BRAȚE

52591
12,00€
0,10
50
100
200



Min: 19mm
Max: 55mm

28,6mm

1-1/8"

3 BRAȚE

52592
19,00€
0,10
5
20
480



Min: 35mm
Max: 85mm

50,8mm

2"

3 BRAȚE

52593
31,30€
0,47
5
20
280



Min: 55mm
Max: 170mm

101,6mm

4"

PASTILĂ ȘLEFUIT 1 - 1/8"
ÎN BLISTER DE 3 UNITĂȚI

11878
3,00€



PASTILĂ ȘLEFUIT 2"
ÎN BLISTER DE 3 UNITĂȚI

11879
3,00€



PASTILĂ ȘLEFUIT 4"
ÎN BLISTER DE 3 UNITĂȚI

11880
5,00€



STETOSCOP

51347	0,15	10	50	300	
9,00€					

91 mm

12mm



32mm

Amplifică și localizează zgomote interne mecanice și de trecere a fluidelor. Localizează repede de unde vine zgomotul motorului. Se pot asculta și zgomotele produse de trecerea lichidelor, pierderi de gaz, presiune de aer sau vapor. Mâner de probă a loviturilor.

SET DE MATRIȚE CU NUMERE

52882	0,30	75	1.500	9
9,80€				PCS

6mm

1/4"

0-8



DIVERSE

STETOSCOP ELECTRIC

N

53249	2,85	5	50
160,95€			



Complet pentru detectarea defecțiunilor la galeri de admisie / evacuare, injectori, radiatoare etc.

Permite monitorizarea simultană a mai multor puncte ale vehiculului, facilitând sarcina operatorului în găsirea și diagnosticarea defecțiunilor.

Sonde cu coduri de culori care fac operațiunea ușoară pentru operator.

Include dispozitiv de prindere pentru senzori.

Caracteristici:

- Lungimea cablului senzorului: 4,8 m
- Lungimea sondei sonore: 14 cm
- Baterii de 9V (incluse)
- Numărul de senzori: 6
- Potrivit pentru conector de 3,5 mm
- Lungimea reglabilă a microfonului: 21cm

PISTOL STROBOSCOPIC

N

53240
37,40€

	2,90
	1
	2

12V	1.5m
3,6W	



Ajustați motoarele cu apăsarea prin.

2 CLEȘTI



SENZOR INDUCTIV



SET DE MATRIȚE CU LITERE ȘI NUMERE

52422	0,82	5	20	540
19,80€				

36 PCS

5mm
3/16"

A-Z & 0-9

53119	1,94	3	6	300
32,00€				

36 PCS

5mm
3/16"

A-Z & 0-9



53119



52422



BARRA EXTENSIBLE MULTIFUNCIÓN

52497	0,29	12	48	576	Min: 53mm Max: 120mm
15,60€	Kg	sub	ff		
53196	0,30	6	48	576	Min: 71mm Max: 160mm
16,35€	Kg	sub	ff		

CON 3 SECCIONES DE ALUMINIO



FUERTE Y LIGERA

Para comprobar el funcionamiento correcto de las luces de freno: extendiendo la barra, un extremo presionando el pedal del freno y el otro el volante.
Para determinar la presión de los neumáticos, eliminar pequeñas piedras o clavos en las ranuras de los neumáticos, levantar el capó superior convenientemente y comprobar el aceite del motor, batería, correa, radiador, etc.



PERIE DE SĂRMĂ

52620	0,12	6	36	1.440	Min: 37mm Max: 6mm
6,90€	Kg	sub	ff		

37 mm burghiu 6mm

Pentru zone de acces dificil.
Funcție de eliberare rapidă.

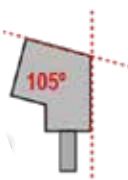

JUEGO DE TRES PINZAS PARA MANGUERAS FLEXIBLES

52066	0,28	50	800	1/2"	3/4"	5/8"	Min: 0-20mm Max: 0-70mm
15,00€	Kg	sub	ff				

Adequado para el circuito de frenos, gasolina y refrigerante. Fabricadas en material ligero y aisladas eléctricamente.

0-20mm

0-35mm

0-70mm

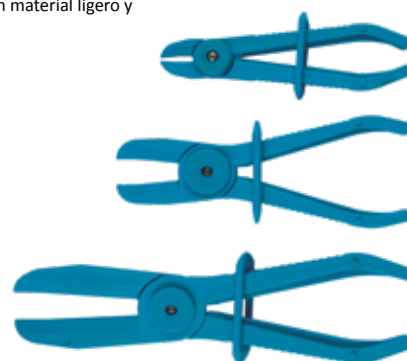

53395	0,3	10	20	360	Min: Ø 10, 15, 24mm
12,35€	Kg	sub	ff		

Ø 10, 15, 24mm



TAVĂ MAGNETICĂ PLIABILĂ

52516	0,42	6	24	1.152	Min: 225mm Max: 88mm
21,80€	Kg	sub	ff		

Diametru superior 225mm
Diametru bază 88mm
Dimensiune desfăcere 135mm
Dimensiune strângere 43mm

52517	5,02	12	72	1.152	Min: 135mm Max: 53mm
9,20€	Kg	sub	ff		

Diametru superior 135mm
Diametru bază 53mm
Dimensiune desfăcere 90mm
Dimensiune strângere 31mm

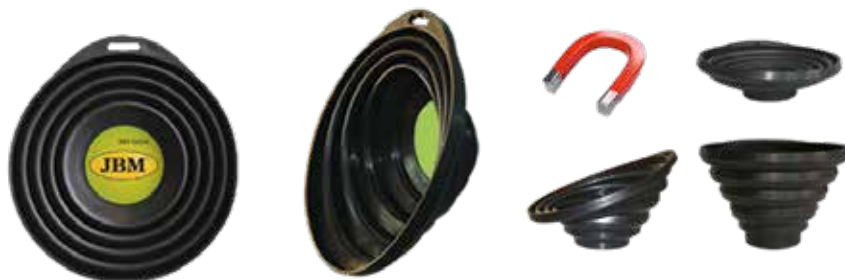

Tavă din plastic cu clapă magnetică pentru a organiza cui, șuruburi și piese de mici dimensiuni.

DIVERSE

TAVĂ MAGNETIZATĂ

50787	0,31	36	648
4,60€	Kg		

x1 \varnothing 150mm



50788	0,62	24	480
9,80€	Kg		

x1 230 x 130mm



CLEȘTE AUTOBLOCANT CU CIOC GHEARĂ DINTĂT

52378	0,36	10	40	720
8,00€	Kg			

3 Kg
6cm



51341	1	12	144
29,80€	Kg		

23 Kg
6cm



SET DE 2 RAFTURI MAGNETIZATE

50790	1,17	12	96
22,00€	Kg		

21x11,5cm

28x11,5cm



MAGNET

52756	0,01	2
6,00€	Kg	

5 Kg

4mm

\varnothing 15mm



x1

RECIPIENT MAGNETIC

52466	0,43	1	20	180
7,40€	Kg			

\varnothing 80mm

112mm

\varnothing 150mm

PLASTIC ABS



SUPORT MAGNETIC

52467	0,50	24	1.008
8,50€	Kg		

40mm

145mm

75mm

Magnet puternic
Căptușit pentru a evita deteriorarea suprafețelor



BARĂ MAGNETICĂ PENTRU INSTRUMENTE

50789	0,89	10	30	300
15,80€	Kg			

600mm

x1



DIVERSE



09



KIT DISTRIBUȚIE

BMW	161
MERCEDES	165
AUDI	166
VOLKSWAGEN	168
RENAULT	172
FORD / MAZDA	173
JAGUAR / LAND ROVER	175
OPEL / VAUXHALL	176
FIAT	178
ALFA	180
CITROËN	181
PEUGEOT	182
VOLVO	182

BLOCAJ PT ARBORELE	183
KIT DISTRIBUȚIE	184
ALTE INSTRUMENTE	185



TIMING TOOLS

KIT DISTRIBUȚIE



KIT DISTRIBUȚIE PE LANȚ BMW N42/N46 1.8,2.0



53259	2,80	5
98,00€		

benzină

MĂRCI	BMW	BMW 1 SERIES: 118i E81/82/87/88 (04-14), 120i E81/82/87/88 (04-14). BMW 3 SERIES: 316i/ti Compact E46 (01-07), 318i/ti Compact E46 (01-07), 318i, E90/91/92/93 (05-12), 320i E90/91/92/93 (05-12). BMW 5 SERIES: 520i E60/61 (07-10), Z4 2.0 E85/86 (04-09). BMW X SERIES: X1 sDrive 18i E84 (10-12), X1 xDrive 18i E84 (10-12), X3 2.0 E83 (05-10).
INSTRUMENTE OEM	11.9.350 (1), 11.9.340 (2), 11.9.291 (3), 11.9.292 (4), 11.9.270 (5), 11.5.120 (6), 11.9.190 (7), 11.9.293 (8)	
CODURILE DE MOTOR	1.8: N42; B18A, N46; B18. / 2.0: N42; B20A, N46; B20, B20B, N46T; B20, B20B, B20BD, B20BZ, B20O2, B2O2.	



KIT DISTRIBUȚIE PE LANȚ BMW N43 1.6 / 2.0



53260	5,60	2	40
217,00€			

benzină

MĂRCI	BMW	BMW 1 SERIES: 116i E81/82/87/88 (07-12), 118i E81/82/87/88 (06-14), 120i E81/82/87/88 (06-14). BMW 3 SERIES: 316i E90/91/92/93 (07-11), 318i E90/91/92/93 (07-13), 320i E90/91/92/93 (07-14). BMW 5 SERIES: 520i E60/61 (07-10).
INSTRUMENTE OEM	11 8 690 (11 8 691/11 8 692/11 8 693) (1), 11 8 710 (11 8 711/11 8 712) (2), 11 3 340 (3) (4), 11 8 700 (5), 11 9 340 (11 9 341/11 9 342) (6), 11 5 120 (7).	
CODURILE DE MOTOR	N43: B16A/AA, B16AA, B16AA/OO, B20A, B20A/AA, B20AA, B20AY, B20KO, B20UO	

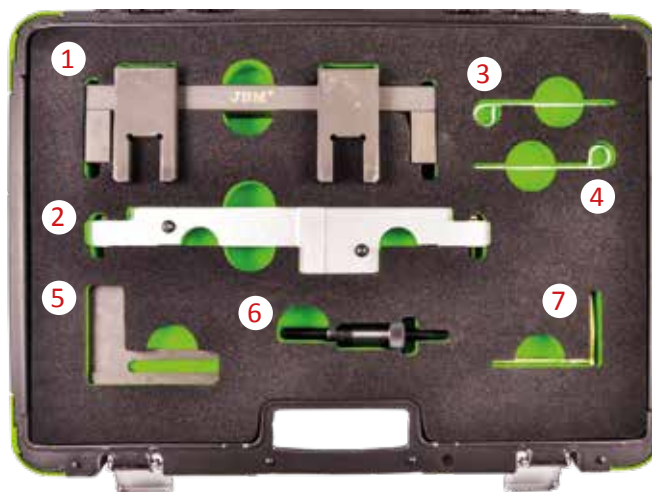

KIT DISTRIBUȚIE PE LANȚ BMW N42/N46



53261	5,20	2	40
196,00€			

benzină

MĂRCI	BMW	BMW 1 SERIES: 118i E81/82/87/88 (04-14), 120i E81/82/87/88 (04-14). BMW 3 SERIES: 316i/ti Compact E46 (01-07), 318i/ti Compact E46 (01-07), 318i E90/91/92/93 (05-12), 320i (E90/91/92/93 (05-14). BMW 5 SERIES: 520i E60/61 (07-10). BMW X SERIES: X1 E84 sDrive 18i (10-12), X1 E84 xDrive 18i (10-12), X3 E83 2.0 (05-10). BMW Z SERIES: Z4 2.0 E85/86 (04-09).
INSTRUMENTE OEM	11 9 190 (1), 11 9 310 (2), 11 9 302 (3)	
CODURILE DE MOTOR	2.0: N42 B18A, N42 B20A, N46 B18, N46 B20, N46 B20B, N46T B20, N46T B20B, N46T B20BD, N46T B20BZ, N46T B20O2, N46T B2O2	



KIT DE DISTRIBUȚIE A ARBOREI CU CAME BMW M52TU/M54/M56



53262	4,60	2	40
218,00€	Kg		

benzină



MĂRCI

BMW

M52TUB25: 1997-2001 E46 323i/323Ci/323ti (M52T), 1998-2001 E39 523i (M52TU), 1998-2001 E36/7 Z3 (M52TU).
M52TUB28: 1997-2001 E46 328i/328Ci (M52TU), 1997-2001 E36/7 Z3 2.8 (M52B28/Z3), 1998-2001 E39 528i (M52TU), 1998-2001 E38 728i (M52TU).
M54B22: 2001-2003 E46 320i/320Ci, 2001-2003 E39 520i, 2001-2002 E36 Z3 2.2i, 2003-2005 E85 Z4 2.2i, 2003-2005 E60/E61 520i.
M54B25: 2001-2002 E36/7 Z3 2.5i, 2001-2005 E46 325i/325xi, 2001-2006 E46 325Ci, 2001-2004 E46 325ti, 2001-2004 E39 525i, 2003-2004 E60/E61 525i/525xi, 2004-2006 E83 X3 2.5i, 2004-2006 E85 Z4 2.5i.
M54B30: 2001-2005 E46 330i/330xi, 2001-2006 E46 330Ci, 2001-2003 E39 530i/2001-2002 E36 Z3 3.0i, 2003-2005 BMW E60 530i, 2003-2006 E85 Z4 3.0i, 2001-2006 E53 X5 3.0i.

INSTRUMENTE OEM

116150 (1), 113450 (1), 113292 (3), 116180 (4), 114220(5)

KIT BLOCAJ PT ARBOREL CU CAME BMW M47



53263	1,80	5
56,50€	Kg	

diesel



MĂRCI

BMW

BMW 1 SERIES: 118d E87 (04-07), 120d E87 (04-07).
BMW 3 SERIES: 318d/td Compact E46 (01-05), 318d/td E90/91 (05-08), 320d/td Compact E46 (98-05), 320d/cd E90/91 (05-08), 325d E90/91/92/93 (02-10), 330d/cd E46/90/91/92/93 (99-07), 335d E90/91/92 (06-11).
BMW 5 SERIES: 520d E39/60/61 (00-09), 525d/xd E39/60/61 (00-10), 530d/xd E46/60/61 (98-10), 535d E60/61 (04-10).
BMW 6 SERIES: 635d E63/64 (07-11).
BMW 7 SERIES: 730d/ld E38/65/66 (98-08).
BMW X SERIES: X3 2.0d E83 (04-07), X3 3.0d/sd E83 (03-10), X5 3.0d E53/E70 (00-10), X6 3.0d E71/72 (08-10), X6 3.5d E71/72 (08-10).
LAND ROVER: Freelander Td4 (00-06), Range Rover Td6 (02-06).
MG/ROVER: MG-ZT/T (01-05), Rover 75 CDT/CDTi (99-05).
VAUXHALL/OPEL: Omega-B (01-03).

INSTRUMENTE OEM

11.2.300/12-108, 12-171/KM-813 (1), 11.3.340/12-172/KM-823 (2) (3), 11.6.322/12-174/KM-6267 (4) 11.6.320 (5)

CODURILE DE MOTOR

BMW

2.0D: M47, M47T2, M47TU / 2.5D: M57, M57T2, M57TU / 3.0D: M57, M57T2, M57TU

LAND ROVER

2.0D: 204D3 (TD4) / 3.0D: 306D1 (TD6)

MG/ROVER

2.0D: M47R / 2.0d CDT: M47R

VAUXHALL/OPEL

2.5D: Y25DT

KIT DISTRIBUȚIE PE LANȚ BMW N62 N73



53264	1,80	5	40
131,50€	Kg		

benzină

MĂRCI

BMW

BMW 5 SERIES: 540i E60/61 (05-10), 545i E60/61 (03-06), 550i E60/61 (05-10).
BMW 6 SERIES: 645i E63/64 (03-06), 650i E63/64 (05-11).
BMW 7 SERIES: 735i E65/66 (02-05), 740i E65/66 (05-10), 745i E65/66 (02-05), 750i E65/66 (05-08), 760i E65/66 (02-08).
BMW X SERIES: X5 4.4 E53 (03-07), X5 4.8 E53/E70 (04-10).

INSTRUMENTE OEM

11.9.463 (1), 11.9.462 (2), 11.9.340 (3), 11.9.461 (4), 11.9.190 (5)

CODURILE DE MOTOR

3.6 V8: N62 B36A
4.0 V8: N62 B40A



KIT DISTRIBUȚIE PE LANȚ BMW DIESEL

N

53265	5,45	2	42
179,50€	Kg		

diesel

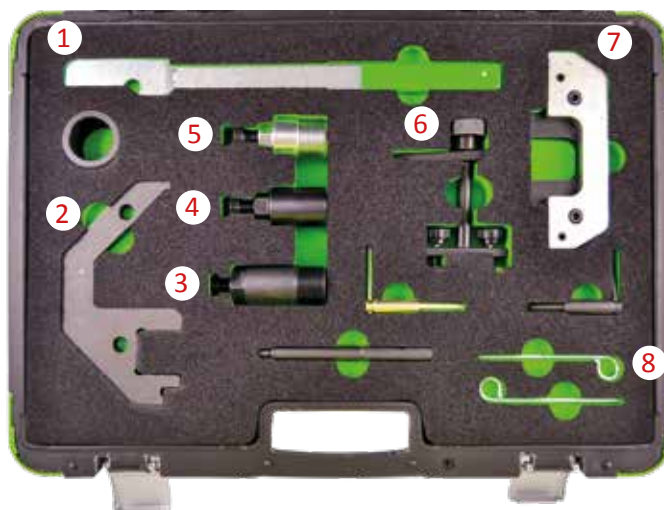

MĂRCI	BMW
INSTRUMENTE OEM	113360 (1), 116321 (2), 135190 (3), 135191 (4), 135192 (5), 116322 (6), 112300 (7), 113340 (8)
CODURILE DE MOTOR	Motor Diesel M41 / M51 / M47TU / M47TU T2. M57TU T2 3.01 1998 - 2008.

KIT DISTRIBUȚIE PE LANȚ BMW

N

53266	6,30	2	42
197,00€	Kg		

diesel

benzină

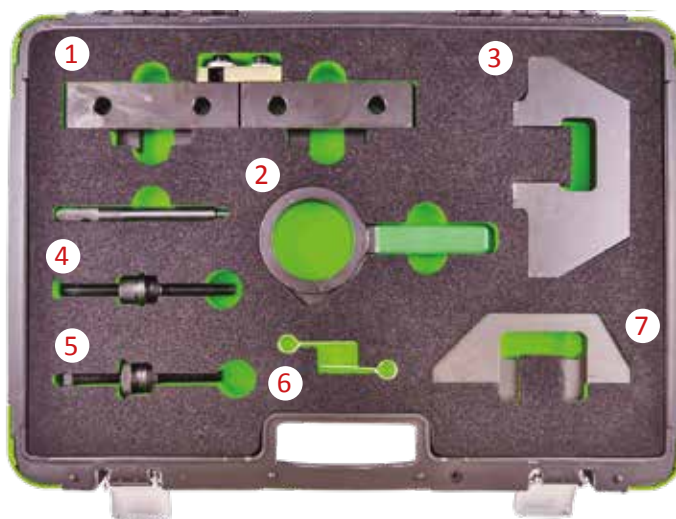

MĂRCI	BMW
INSTRUMENTE OEM	113240 (1), 115490 (2), 113190 (3), 112300 (4) (5), 113292 (6), 113320 (7)
CODURILE DE MOTOR	<u>BENZINĂ</u> : M42, M43, M50, M52, M60. <u>DIESEL</u> : M51

KIT DISTRIBUȚIE PE LANȚ BMW M42 / 44 / 50 / 52 / 54 / 56

N

53267	8	2	40
248,00€	Kg		

benzină



MĂRCI	BMW	SERIES: 3, 5, 7, X, Z
INSTRUMENTE OEM	114220 (1), 112300 (2), 113240 (3), 115490 (4) 113292 (5), 113450 (6)	
CODURILE DE MOTOR	M40. M44. M50. M52. M54. M56.	

KIT DISTRIBUȚIE PE LANȚ BMW MINI, PȘA 1.4, 1.6

N

53268
108,00€

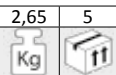

benzină

MĂRCI

BMW MINI: Mini Clubvan R55 (12-14), Mini Clubman R55 (08-14), Mini Countryman R55 (07-10), Mini Clubman R56/R57 (07-15), Mini R56/R57 (08-15), Mini Coupe R58 (11-15), Mini Roadster R59 (08-15), Mini Clubman R60 (10-14), Mini Clubvan R60 (12-14), Mini Roadster R61 (13-15), Mini Paceman R61 (14-15), Mini Countryman R60 (10-17).

CITROËN: C4 (08-11), C4 Picasso (08-13) C4 Grand Picasso (13-15).

PEUGEOT: 207 (06-14), 207CC (07-15), 308 (07-15), 3008 (09-15), 5008 (09-15).

INSTRUMENTE OEM

BMW MINI: 11 5 590 (1), 11 9 340 (2), 11 9 551 (3)

CITROËN: 0197-A1, 0197-A3, 0197-B.

PEUGEOT: 0197-A1, 0197-A3, 0197-BZ.

CODURILE DE MOTOR

1.4: N12B14, N14B14AB.

1.6: EP3(8FS), EP3C(8FR), EP6(5FW), EP6C(5FS), EP6CDT(5FV), EP6DT(5FT), EP6D-T(5FX), EP6DTS(5FY), N14B16A, N14B16CD, N14B16TO, N14B16CD/TO, N16B16A, N16B16KO, N16B16A/MO, N16B16A/MO, N16B16MO, N16B16UO.



KIT DISTRIBUȚIE PE LANȚ BMW

N

53269
46,00€

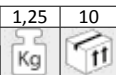

diesel

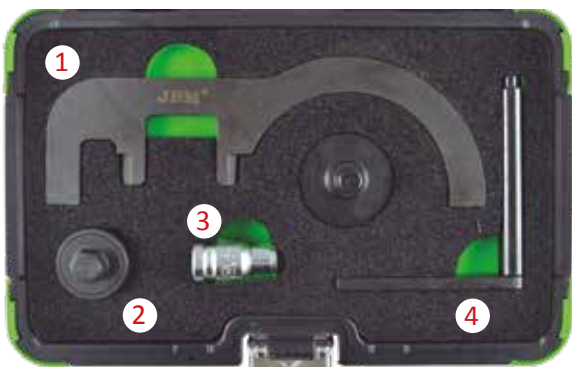

MĂRCI

BMW

BMW 1 SERIES: 116d E81/82/87/88 (08-12), 118d E81/82/87/88 (07-14), 120d E81/82/87/88 (07-14), 123d E81/82/87/88 (07-14).

BMW 2 SERIES: 218d (11-14), 220d (11-14), 225d (11-14).

BMW 3 SERIES: 316d E90/91/92/93 (09-12), 318d E90/91/92/93 (07-12), 320d E90/91/92/93 (07-12), 325d E90/91/92/93 (10-14), 330d/xd E90/91/92/93 (08-14).

BMW 5 SERIES: 520d E60/61 (07-10), 525d F10/11 (10-12), 530d F10/11 (10-13), 530dGT F07 (09-12), 535d F10/11 (10-17), 535dGT F07 (10-12).

BMW 7 SERIES: 730d/Ld F01/02/04 (08-12), 740d F01/02/04 (09-12), 740d xDrive F01/02/04 (09-12), 750d xDrive F01/02/04 (12-15).

BMW X SERIES: X1 sDrive 18d E84 (09-15), X1 sDrive 20d E84 (09-12), X1 xDrive 18d E84 (09-15), X1 xDrive 20d E84 (09-15), X1 xDrive 23d E84 (09-12), X3 2.0d E83 (07-10), X3 xDrive 18d E83 (08-10), X3 xDrive 30d E83 (11-12), X3 xDrive35d F25 (11-17), X5 3.0d E70 (10-13), X5 xDrive 40d X5 F15 M50d (13-17), E70 (10-13), X6 xDrive 30d E71/72 (10-14), X6 xDrive 40d E71/72 (10-14), X6 F16 M50d (14-17).

BMW MINI: Paceman (13-17), Countryman (10-17), Mini (10-15), Roadster (12-14), Clubman (10-14), Clubvan (12-14).

INSTRUMENTE OEM

11.8.760 (1), 1.8.740 (2), 11.6.480 (3), 11.5.320 (4)

CODURILE DE MOTOR

1.6 D: N47; C16K1, C16U1.

2.0 D: N47; C20K1, C20U1N47; D20, D20A, D20B, D20D, D20K1, D20O0, D20O1, D20T1, D20U0, D20U1, N47S D20TO, N47T; D20, D20O1, D20U1.

3.0 D: N57; B30B, B30B/TO, B30C, D30BTO, D30O0, D30O1, D30TO, D30T1, D30U0.

KIT DISTRIBUȚIE PE LANȚ MERCEDES / CHRYSLER / JEEP

N

53270
62,00€

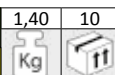

diesel

benzină

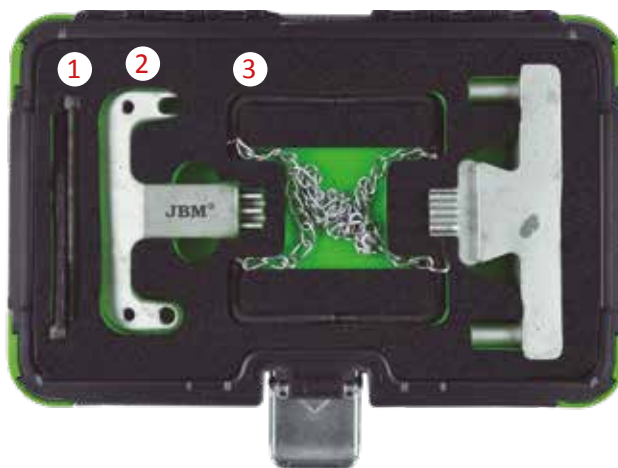

MĂRCI

BMW MINI: Mini Clubvan R55 (12-14), Mini Clubman R55 (08-14), Mini Countryman R55 (07-10), Mini Clubman R56/R57 (07-15), Mini R56/R57 (08-15), Mini Coupe R58 (11-15), Mini Roadster R59 (08-15), Mini Clubman R60 (10-14), Mini Clubvan R60 (12-14), Mini Roadster R61 (13-15), Mini Paceman R61 (14-15), Mini Countryman R60 (10-17).

CITROËN: C4 (08-11), C4 Picasso (08-13) C4 Grand Picasso (13-15).

PEUGEOT: 207 (06-14), 207CC (07-15), 308 (07-15), 3008 (09-15), 5008 (09-15).

INSTRUMENTE OEM

112 589 03 40 00 (1), 601 589 02 40 00 (2), 111 589 03 15 00 (3)

CODURILE DE MOTOR

Herr: 112 589 03 40 00: 112, 113, 137, 155, 156, 272/979, 273, 629, 642/992.

Herr: 601 589 02 40 00: 102, 103, 104, 111, 601, 602.91/93/94/96/983, 603.91/93/96/97, 604, 605, 606, 611, 612/965/966, 613.

Herr: 111 589 03 15 00: 111, 119, 604, 605, 606, 611/980, 612, 613, 628, 629, 640, 642/922, 612.965/966, 646, 647, 648.

SET FIXARE DISTRIBUȚIE PENTRU BMW

51940	5,67	2	60
399,00€	Kg		

Permite o corectă aliniere de poziție a arborelui cu came și a arborelui cotit pentru schimbul curelei de distribuție sau lanțului de la motoarele pe benzină și diesel.

-Include o cheie pentru o corectă rotație a pinionului arborelui cu came, de evacuare în timpul instalării și deinstalării de la unitatea VANOS.

- Include un instrument de preîncărcare a primului lanț de distribuție, pentru tensionarea lanțului de distribuție în motoare M59, metric cu filet 22 pentru motoare M42/M60 și metric cu filet de 26 pentru motoare M50/M52.

- Motoare asumate: M42 / M44 / M50 / M52 / M54 / M56



KIT DISTRIBUȚIE PE LANȚ MERCEDES BENZ M271



53271	4,55	2	42
207,00€	Kg		

benzină

MĂRCI	MERCEDES
INSTRUMENTE OEM	271 589 003100 (1), 271589014000 (2), 271589001500 (3)
CODURILE DE MOTOR	M271. E18ML 2002. DE18ML 2003 - 2005. E16ML 2008. DE18LA 2009.

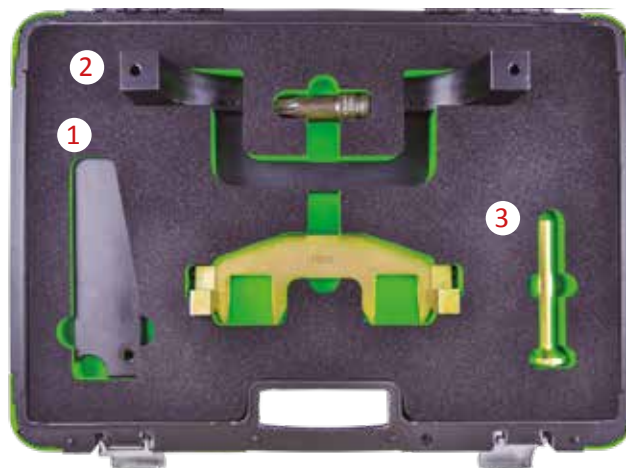

KIT DISTRIBUȚIE PE LANȚ MERCEDES AMG 156



53272	2,1	5
163,00€	Kg	

diesel

benzină

MĂRCI	MERCEDES
INSTRUMENTE OEM	156 589 00 61 00 (1), 156 589 00 32 00 (2), 156 589 01 63 00 (3), 156 589 00 61 00 (3)
CODURILE DE MOTOR	BENZ AMG 156.ML 63 AMG.S 63L AMG.S 63. AMG. R 63 AMG L 4MATIC. R63 AMG 4MATIC. E 63 AMG. CLS 63 AMG. CLK 63 AMG. CLK 63 AMG Black series. CLK 63 AMG Cabrio. CL 63 AMG.

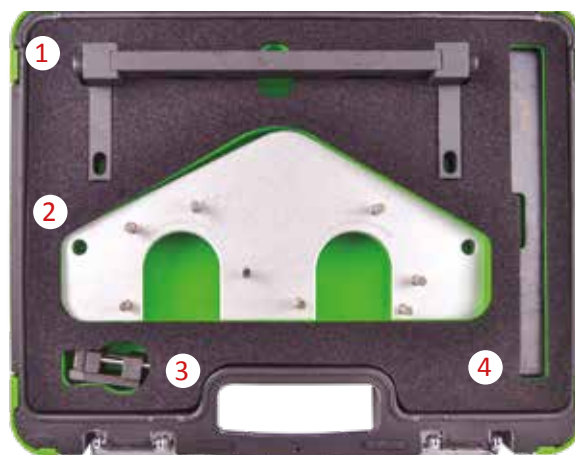

KIT DISTRIBUȚIE PE LANT MERCEDES M276, M157, M278

N

53273

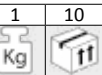

68,00€

benzină



MĂRCI	MERCEDES
INSTRUMENTE OEM	27658901400
CODURILE DE MOTOR	CL 500 / 63 AMG (C 216) 2010–2013. S 500 / 63 AMG (C 217) 2014. CLS 300 (C 218) 2012. E 300 / 350 / 400 (C/A 207) 2011. CLS 350 / 400 / 500 / 63 AMG (C/X 218) 2011–2014. SLK 350 (R 172) 2011. SL 350 / 400 / 500 / 63 AMG (R 231) 2012. S 500 PLUG-IN HYBRID (V 222) 2014. ML 300 / 350 / 500 / 63 AMG (W 166) 2011. C 400 (W 205) 2014. E 400 HYBRID (W 212) 2012. G 63 AMG (W 463) 2012. E 300 / 350 / 400 / 500 / 63 AMG (W/S 212) 2011. C 350 (W/S/C 204) 2011. S 350 / 500 / 63 AMG (W/V 221) 2010. S 400 / 63 AMG (W/V 222) 2013. R 350 BlueEFFICIENCY (W/V 251) 2012. GL 450 / 500 (X 166) 2012. GLK 350 (X 204) 2011.

KIT ALINIERE PT ARBORELE CU CAME VW AUDI

N

53280

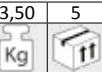

97,50€

benzină



MĂRCI	AUDI: A4 (01-08), A6 (01-08), A8 (03-10).
INSTRUMENTE OEM	3387 (1), T40030 (2) (4), T40026 (3), T40028 (5)
CODURILE DE MOTOR	3.0 V6 30v: ASN, AVK, BBJ, BGN.

KIT DISTRIBUȚIE PE LANT AUDI V6 2.0 / 2.8 / 3.0 TFSI

N

53278



132,00€

benzină

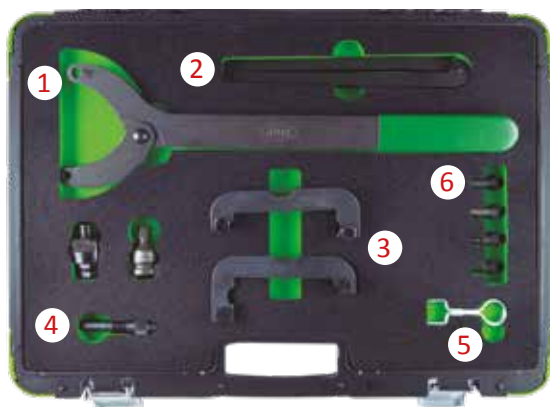

MĂRCI	AUDI: Q5, V6 2.0, 2.8, 3.0T FSI SEAT: Ibiza/Cordoba, Toledo, Alhambra, Inca 1.6, 1.8, 1.8 16v, 2.0, 2.0 16v, Ibiza/ Cordoba, Leon, Toledo 1.6 (99-), Alhambra 2.0 (00-). VOLKSWAGEN: V6 2.0, 2.8, 3.0T FSI. AUDI/VOLKSWAGEN: V6 2.0, 2.8, 3.0T FSI. AUDI Q5: 2.0, A6L 2.8, 3.0T.
INSTRUMENTE OEM	T10172 (1), 3212 (2), T40070 (3), T40069 (4), T40071 (5), T10172/2 (6)
CODURILE DE MOTOR	2.0, 2.8, 3.0

UNELTE PENTRU CUREAUA DE DISTRIBUȚIE BMW / AUDI

N

53277	1,6	5
30,50€	Kg	11

diesel **benzină**



MĂRCI	BENZINĂ	<u>AUDI</u> : 80, 100, A3, A4, A6 1.6, 1.8/Turbo, 2.0, 2.0 16v, A3, A4 1.6 (96-). <u>SEAT</u> : Ibiza/Cordoba, Toledo, Alhambra, Inca 1.6, 1.8, 1.8 16v, 2.0, 2.0 16v, Ibiza/ Cordoba, Leon, Toledo 1.6 (99-), Alhambra 2.0 (00-). <u>VOLKSWAGEN</u> : Polo Classic, Scirocco, Corrado, Golf, Jetta, Vento, Passat, Sharan, Transporter 1.6, 1.8/Turbo, 1.8 16v, 2.0, 2.0 16v, Polo Classic, Golf, Bora, Beetle 1.6 (97-), 2.0 (99-). <u>SKODA</u> : Octavia 1.6 (97-), 2.0 (99-).
	DIESEL	<u>AUDI</u> : 80, 100, A3, A4, A6 1.9 Turbo D, 1.9TDi, 2.5TDi, A3, A4, A6 2.0TDi, A2, A3, A4, A6 1.2TDi, 1.4TDi, 1.9TDi (99-). <u>SEAT</u> : Ibiza/Cordoba, Leon, Toledo, Alhambra, Inca 1.7SDi, 1.9D/TD / Sdi/Tdi. <u>FORD</u> : Galaxy (02-06). <u>SKODA</u> : Felicia, Octavia 1.9D/Tdi. <u>VW</u> : Polo, Polo Classic, Golf, Jetta, Vento, Bora, Beetle, Passat, Sharan, Caddy, Transporter 1.5D, 1.6D/ Turbo, 1.7D/Sdi, 1.9Sdi/Tdi, Golf, Passat 2.0TDi.
INSTRUMENTE OEM	T10020 (1), 3387 (2), V159 (3), T10060/T100604 (4), T10115 (5), T40011 (6)	
CODURILE DE MOTOR	2.0, 2.8, 3.0	

KIT DISTRIBUȚIE PE LANȚ, AUDI / ŠKODA

N

53276	5,30	2	42
146,00€	Kg	11	11

diesel **benzină**

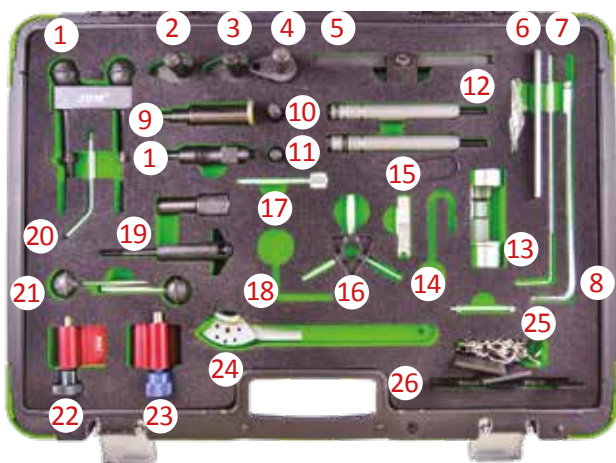

MĂRCI	<u>AUDI VW MOTOARE</u> : V6 2.0, 2.8, 3.0T FSI. <u>AUDI Q5</u> : 2.0, A6L 2.8, 3.0T.
INSTRUMENTE OEM	T0016 (1), T10123 (2) (3), T10098A (5), T10264 (7), T10265 (8), 3369 (12), T10120 (13), T10008 (15), T10060/T10060A (18), 2064 (19), T20102/3359 (21), T10050 (22) T10100 (23), 3458 (26)
CODURILE DE MOTOR	2.0, 2.8, 3.0

KIT ALINIERE PT ARBORELE CU CAME VW / AUDI

N

53281	1,30	5
53,50€	Kg	11

diesel



MĂRCI	<u>VOLKSWAGEN</u> : 2.5 TDi V6 DIESEL <u>AUDI</u> : A4, A6, A8
INSTRUMENTE OEM	3369 (1), 3242 (2), 3458 (3)
CODURILE DE MOTOR	AFB/AKN

KIT DISTRIBUȚIE PE LANȚ VW / AUDI

N

53282

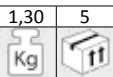

48,00€

benzină

MĂRCI

SEAT: Alhambra (10-15), Altea/Altea XL (08-15), Ibiza/ Cordoba (08-12), Leon (07-13), Toledo (07-15).
VOLKSWAGEN: Beetle (11-15), Caddy/Caddy Maxi (10-15), EOS (06-12), Golf (03-12), Golf Plus (03-14), Golf V Estate (07-13), Golf VI Cabriolet (10-15), Jetta (06-14), Passat (05-11), Polo (02-14), Scirocco (08-12), Tiguan (07-12), Touran (03-15).
SKODA: Fabia II (07-15), Octavia II (04-15), Praktik (10-15), Rapid (12-15), Roomster (06-15), Superb II (09-14), Yeti (09-14).
AUDI: A1 (10-15), A3 (03-13).

INSTRUMENTE OEM

T10171 (1), T10170 (2), T40011 (3)

CODURILE DE MOTOR

1.2 TFSi: CBZA, CBZB, CBZC.
1.4 FSi: AXU, BKG, BLN.
1.4 TFSi: BLG, BMY, BWK, CAVA, CAVB, CAVC, CAVD, CAVE, CAVF, CAXA, CAXC, CDGA, CSMA.
1.6 FSi: BAG, BLF, BLP, BTS.



KIT DISTRIBUȚIE PE LANȚ VW / AUDI 2.0TFSI

N

53279

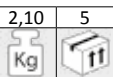

89,00€

benzină



MĂRCI

AUDI: A3 (96-09), A4 (94-09), A6 (95-11), S3 (99-13), TT (98-14).
SEAT: Alhambra (97-10), Altea/Altea XL (06-09), Cordoba (99-02), Exeo (09-10), Ibiza (99-02), Leon (99-13), Toledo (99-09).
SKODA: Octavia/Octavia Tour (98-10), Octavia II (04-09).
VOLKSWAGEN: Beetle (99-11), Bora (97-04), Eos (06-10), Golf (97-12), Golf Plus (05-09), Jetta (05-09), Passat (96-10), Scirocco (09-14), Sharan (97-10), Touran (03-09).

INSTRUMENTE OEM

T10020 (1), T10252 (2), T10092 (3), T10115 (4), T40011 (4), 3366 (5), T10060 (6)

CODURILE DE MOTOR

1.8: ADR, AFY, AGN, AJP, APG, APT, AQE, ARG, ARH, AVV.
1.8T: AEB, AGU, AJH, AJL, AJQ, AMK, AMU, ANB, APP, APU, APX, APY, AQA, AQX, ARX, ARY, ARZ, AUM, AUQ, AVC, AWC, AWT, AWU, AYP, BAM, BFV, BVP, BVR.
2.0 FSi: AXW, BHD, BLR, BLX, BLY, BMB, BVX, BVY, BVZ.
2.0 TFSi/S/R/Tsi: AXX, BPY, BWA, BGB, BPG, BPJ, BUL, BWE, BWT, BYK, BHZ, BZC, BWJ, BYD, CDLA, CDLB, CDLC, CDLD, CDLF, CDMA.

KIT DISTRIBUȚIE PE LANȚ VOLKSWAGEN 1.2L

N

53274

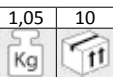

40,00€

benzină

MĂRCI

VOLKSWAGEN
1.2: Lupo / Polo / Eos / Fox.
SEAT
1.2: Ibiza / Cordoba
SKODA
1.2: Fabia

INSTRUMENTE OEM

T10123 (1) (2), T10120 (3), T10121 (4)

CODURILE DE MOTOR

AWY / BMD / AZQ / BME.



KIT DISTRIBUȚIE PE LANȚ VW / AUDI

N

53326	0,30	10	40
13,50€	Kg	5.6	11

diesel



1

MĂRCI	VW: V6 2.5TDI. AUDI: V6 2.5TDI, V8 3.3TDI.
INSTRUMENTE OEM	3458 (1), T40069 (2)

KIT DISTRIBUȚIE PE LANȚ VW 1.2L

N

53327	0,20
13,50€	Kg

10	5.6
60	11

benzină



MĂRCI	AUDI: A1, A3, A3 cabrio 1.2 TSI. VW: Polo, Touran, Caddy, Caddt maxi, Golf, Golf plus, Golf estate, Jetta, Golf VI cabrio.
INSTRUMENTE OEM	T10414.
CODURILE DE MOTOR	CBZA, CBZB.

KIT DISTRIBUȚIE PE LANȚ VAG 2.7 & 3.0 TDI

N

53283	2,10	5
92,00€	Kg	11

diesel



MĂRCI	VOLKSWAGEN: Touareg, Phateon VAG: Diesel 2.7 / 3.0 V6 AUDI: A4, A5, A6
INSTRUMENTE OEM	3242 (1), T40060 (2) (3), 3359 (4), T40058 (5), T40061 (6), T40062 (7), T40049 (8)
CODURILE DE MOTOR	AJB, BKN, BKS, BWZ, BNG, BPP, BSG, BUG, BUN, CAWA, CAMB, CANA, CANB, CANC, CAND, CAPA, CARA, CARS, CASA, CASE, CASC, CAM, CC/HA, CCWA, CCWB, CDYA, CDVB, CDVC, CEXA, CGKA, CGKB.

KIT DISTRIBUȚIE PE LANȚ VAG 2.5 / 4.9D / TDI

N

53284	9,40	2	42
285,00€	Kg	11	11

diesel

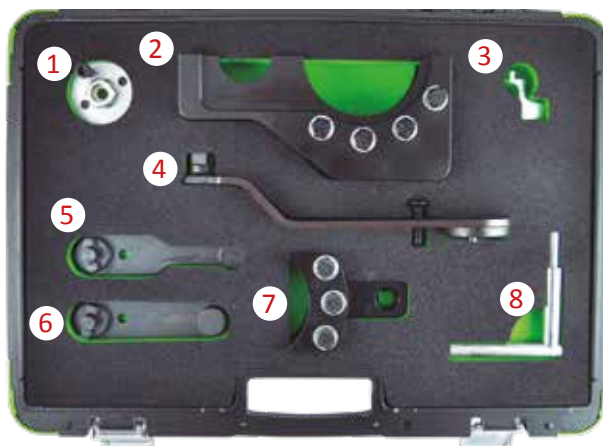

MĂRCI	VOLKSWAGEN: Touareg (03-10), Transporter (03-09).
INSTRUMENTE OEM	T10225 (1), T10199 (2), T10234 (3), T10226 (4), T10193 (5), T10194 (6), T10199/01 (7), T10226 (8)
CODURILE DE MOTOR	2.5D TDi PD: AXD, AXE, BAC, BLJ, BLK, BNZ, BPC, BPD, BPE.

KIT DISTRIBUȚIE PE LANȚ VAG 2.4 / 2.5D SDI

N

53285
48,50€

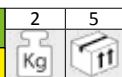

diesel



MĂRCI VOLKSWAGEN: Crafter (06-13), LT (96-06), Transporter (90-03).

INSTRUMENTE OEM 2065A (1), T50009 (2), T10025 (3), 3248/3419 (4), 2064 (5), 3355 (6)

CODURILE DE MOTOR
2.4D: AAB, AJA.
2.5D SDI: AGX.
2.5D Tdi: ACV, AHD, AHY, AJT, ANJ, APA, AUF, AVR, AXG, AXL, AYC, AYY, BBE, BBF.
2.5D TDiCR: BJJ, BJK, BJL, BJM.

KIT DISTRIBUȚIE PE LANȚ VAG 1.8 / 2.0 TSI

N

53286
95,00€

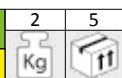

benzină

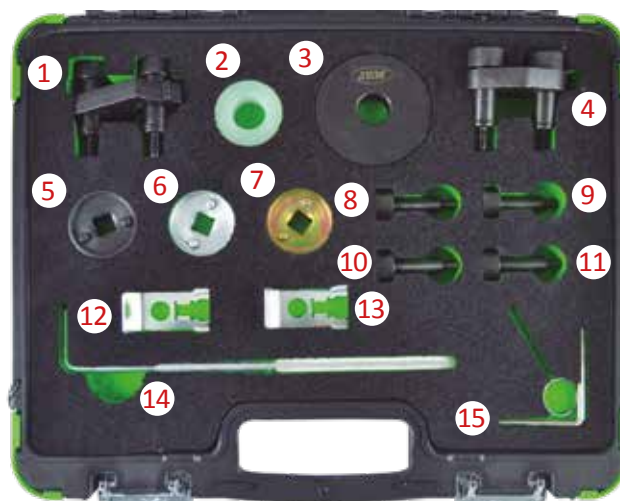

MĂRCI VOLKSWAGEN: 1.8 / 2.0 TSI / TFSI.

INSTRUMENTE OEM T10368 (2), T10354 (3), T40271 (4), T10352/2 (5), T10352/1 (6), T10352 (7), T40196 (8) (9) (10) (11), T40267 (12) (13), T40098 (14), T10060A (15), T40011 (15)

CODURILE DE MOTOR BYT, BZB, CABA, CABB, CABD, CADA, CAEA, CAEB, CAWA, CAWB, CBFA, CCTA, CCZA, CCZB, CCZC, CDAA, CDAB, CDHA, CDHB, CDNB, CDNC, CDND, CESA, CETA, CFKA, CGYA, CJEB, CJBA, CJSB.

KIT DISTRIBUȚIE PE LANȚ VW / AUDI 1.8/2.0L TURBO

N

53287
221,50€



benzină

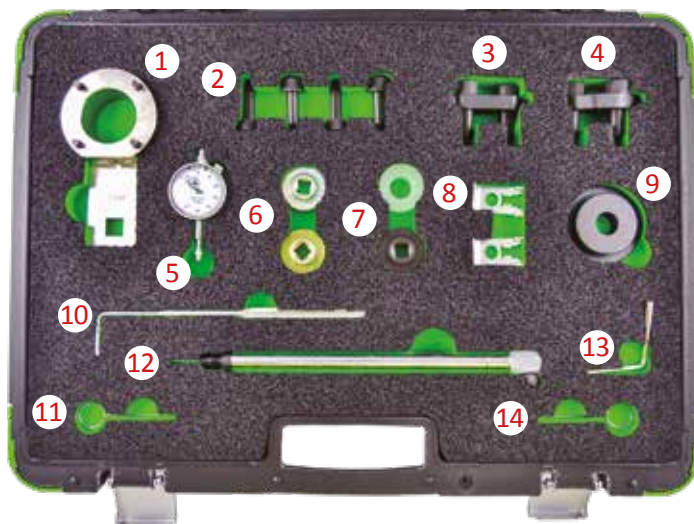

MĂRCI VOLKSWAGEN | 1.8 / 2.0 TURBO
AUDI

INSTRUMENTE OEM T10355 (1), T40196 (2), T40271 (3) (4), T10352 (5), T10352/1 (6), T10352/2 (7), T10368 (7), T40267 (8), T10354 (9), T40265 (10), T40011 (11) (14), T40098 (12), T10060A (13)

CODURILE DE MOTOR BYT, BZB, CABB, CABD, CADA, CAEA, CAEB, CAWA, CAWB, CBFA, CCTA, CCZA, CCZB, CCZC, CDAA, CDAB, CDHB, CDNB, CDNC, CDND, CESA, CETA, CFKA, CGYA, CJEB, CJSB, CJSB.

KIT DISTRIBUȚIE PE LANȚ VW / AUDI



53275	0,7	10
35,50€	Kg	11

diesel



MĂRCI

DODGE: Caliber (06-11)
FORD: Galaxy (02-06)
MITSUBISHI: Grandis (05-10), Lancer (05-10), Outlander (07-10).
SEAT: Alhambra (00-15), Altea/Altea XL (04-15), Cordoba (02-09), Ibiza (02-15), Leon (00-13), Toledo (04-11).
SKODA: Fabia (00-14), Fabia II (07-15), Octavia (00-10), Octavia II (04-15), Praktik (10-15), Rapid (11-15), Roomster (07-15), Superb (02-08), Superb II (08-15), Yeti (09-14).
AUDI: A1 (10-15), A2 (00-06), A3 (01-13), A4/Allroad (01-16), A5 (08-15), A6 (11-14), TT (08-14), Q3 (11-15), Q5 (08-15), A6 (10-14).
VOLKSWAGEN: Amarok (10-16), Beetle (02-15), Bora (02-08), Caddy/Maxi (03-15), EOS (06-15), Fox (05-11), Golf (02-15), Golf Plus (05-14), Jetta (05-15), Lupo (02-05), Passat/CC (02-15), Polo (99-14), Scirocco (08-14), Sharan (02-15), Tiguan (07-15), Touran (03-15), Transporter (03-17).

INSTRUMENTE OEM

DODGE: 9882, 9883.
FORD: 310-085/23-059, 303-1054.
MITSUBISHI: MB995206, MB995208, MB995209.
VAG: T10100 (4), T10050 (1), 3359 (3/6)/T20102, T10115 (3), T10060A (2)/T40098, T20167.

CODURILE DE MOTOR

1.2D TDi CR: CFWA.
1.4D TDi PD: AMF, BAY, BMS, BNM, BNV, BWB.
1.6D TDi CR: CAYA, CAYB, CAYC, CAYD, CAYE, CLNA.
1.9D TDi PD: AJM, ANU, ARL, ASZ, ATD, AUJ, AVB, AVF, AVQ, AWW, AXB, AXC, AXR, BJB, BKC, BLS, BLT, BMT, BPZ, BRM, BRR, BRS, BRU, BSU, BSV, BSW, BTB, BVK, BXE, BXF, BXJ.
2.0D TDi CR/TDi PD: AZV, BDJ, BDK, BEW, BGW, BHW, BKD, BKP, BKQ, BLB, BMA, BMM, BMN, BMP, BMR, BNA, BPW, BRA, BRC, BRD, BRE, BRF, BRT, BSS, BST, BSY, BUY, BUZ, BVA, BVE, BVF, BVG, BVH, BWC, BWV, CAAA, CAAB, CAAC, CAAD, CAEE, CAGA, CAGB, CAGC, CAHA, CAHB, CBAA, CBAB, CBAC, CBBA, CBBB, CBDA, CBDB, CBDC, CBEA, CCHA, CCHB, CDAA, CDCA, CEGA, CFCA, CFFA, CFFB, CFFD, CFFE, CFGB, CFGC, CFHA, CFHB, CFHC, CFHD, CFHE, CFHF, CFJA, CGLA, CGLB, CGLC, CGLD, CAAA, CICA, CIBC, CIJC, CLCA, CLCB, CLJA, CLLA, CNEA, ECD, ECD/BSY, ECD/BYL, ECE/BWD.

KIT DISTRIBUȚIE PE LANȚ VAG 1.6/ 2.0L TDi PD COMMON RAIL



53288	2,15	5
72,00€	Kg	11

diesel

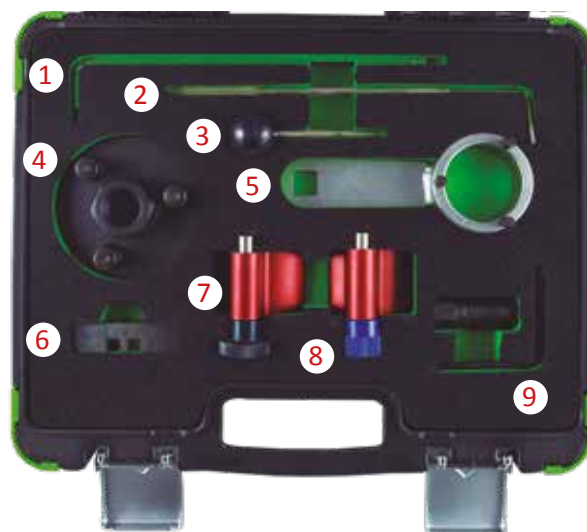

MĂRCI

SEAT: Exeo, Leon, Altea, Toledo, Ibiza.
VOLKSWAGEN: Jetta, Touran, Golf, Golf Plus, Polo, Passat, Tiguan, Scirocco.
SKODA: Roomster, Fabia, Praktik, Octavia, Yeti, Superb.
AUDI: A1, A3, A4, A5, Q5, A6, TT.

INSTRUMENTE OEM

T10264 (1), T10265 (2), T20102 (3), T10052 (4), T10051 (5), T10255 (6), T10050 (7), T10100 (8), T40098 (9)

CODURILE DE MOTOR

1.2 TDI CR, 1.6 D TDI CR, 2.0 D TDI CR
 CAGA, CAGB, CAGC, CAHA, CAHB, CFHC, CBAA, CBAB, CFFB, CGLA, CGLB, CICA, CIBC, CAAA, CBAA, CBAB, CBAC, CBBA, CBBB, CBDA, CBDB, CBDC, CCHA, CEGA, CAAA, CAAB, CAAC, CFJA, CFWA, CAYB, CAYC, CAYA.

SET FIXARE DISTRIBUȚIE PT. SEAT / VW / AUDI / SKODA

51943	5,13	2	64
385,00€	Kg	11	11



MĂRCI

AUDI: 80, 100, A2, A3, A4, A6, TT
SEAT: Terra, Ibiza, Córdoba, Leon, Toledo, Inca, Alhambra
SKODA: Fabia, Felicia y Octavia.
VW: Lupo, Polo/Classic, Caddy, Golf, Jetta, Vento, Bora, New Beetle, Passat, Sharan, Transporter y LT

KIT DISTRIBUȚIE PE LANȚ RENAULT 1.4 / 1.6 / 1.8 / 2.0 16V



53289	1,50	5
50,00€	Kg	ff

benzină

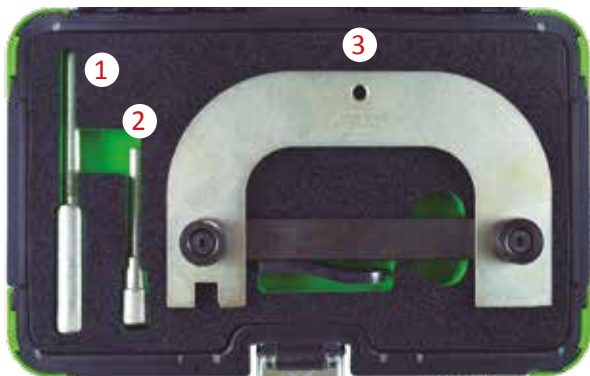

MĂRCI

RENAULT: Espace/Grand Espace (98-02), Espace/Grand Espace IV (02-10), Kangoo/Trekka (01-09), Laguna (98-01), Laguna II (01-07), Laguna III (07-13), Megane (99-03), Megane II (02-10), Megane III/ Sport (08-13), Megane/Scenic (99-00), Scenic/RX4 (99-03), Scenic/ Grand Scenic II (03-09), Trafic II (01-11), Twingo II (08-14), Vel Satis (00-10), Wind (10-14)

DACIA: Logan/MCV (05-11).

NISSAN: Kubistar X76 (03-09), Primastar (02-11).

VAUXHALL/OPEL: Jetta, Touran, Golf, Golf Plus, Polo, Passat, Tiguan, Scirocco.

INSTRUMENTE OEM

Mot1489 (1), Mot1054 (2), Mot1496 (3)

CODURILE DE MOTOR

1.4 16v K4J: 730, 732, 740.

1.6 16v K4M: 752, 753, 760, 761, 764, 788, 812, 813, 854, 856.

1.8 16v F4P: 720, 722, 760, 770, 771, 772, 773, 774, 775.

2.0 16v F4R: 700, 701, 712, 713, 714, 715, 720, 722, 730, 732, 736, 738, 740, 741, 744, 746, 747, 762, 763, 764, 765, 766, 767, 770, 771, 780, 790, 791, 792, 820, 830, 832, 867.

2.0 16v F4R(t): 720, 722, 764, 765, 774, 776, 784, 786, 787, 794, 795, 796, 797, 800, 802, 810, 811, 870, 872, 874, 886, 887, 896, 897.

KIT DISTRIBUȚIE PE LANȚ RENAULT / VOLVO 16V/20V



53290	1,90	5
49,00€	Kg	ff

benzină



MĂRCI

RENAULT: Laguna 2.0 16V / 2.5 20V (1996-1999) Safrane 2.0 16V / 2.5 20V (1996-2001)

VOLVO: 850(1992-1997), C70(1998-2002), S40(1996-2004), V40(1996-2004), S60(2001-2005), S70(1997-2000), S80(1999-2005).

INSTRUMENTE OEM

MOT1348 (1), MOT1337 (2), MOT1340 (3)

CODURILE DE MOTOR

RENAULT: N7Q 704/710/711(2.0 16V),N7U 700/701(2.5 20V).
VOLVO: B4164S, B4164S2, B4184S, B4184S2, B4184S3, B4184S9, B4184S10, B4194T, B5194T2, B420S4, B4204S2, B4204T, B4204T2, B4204T3, B4204T5, B5202Fs,B5204FT, B5204T2, B5204T3, B5204T4, B5204T5, B5234FS, B5204FT, B5234T3, B5234T4, B5234T5, B5234T6, B5234T7, B5234T8, B5234T9, B5244S, B5244S2, B5244SG, B5244SG2, B5244T, B5244T3, B5244T4, B5244T5, B5244T7.

SET FIXARE DISTRIBUȚIE PENTRU OPEL / RENAULT / NISSAN

51942	6,10	2	64
359,00€	Kg	ff	ff

Funcțiuni: fixarea volanului / arbore cu came / arbore cotit / pompă de injecție.

Pentru motoare diesel Renault ,Opel (Vauxhall), Volvo.
Pentru blocarea arborelui cu came și arborelui cotit, pentru schimbarea curelei de distribuție sau pentru repararea motorului Renault.

MĂRCI

RENAULT: Avantime, Clio, Espace, Kangoo, Laguna, Master, Megane, Modus, Scenic, Twingo, Traffic
OPEL/VAUXHALL: Movano, Vivaro.

CODURILE DE MOTOR

BENZINĂ: 2.0 16V, 2.5 20V, 1.4, 1.6 16V, 1.8, 2.0 16V, 1.2, 1.7, 1.8, 2.0 16V, 2.2
DIESEL: 1.5, 1.9, 2.5, 2.8



KIT DISTRIBUȚIE PE LANȚ RENAULT

N

53291	2,50	5
68,00€	Kg	11

benzină

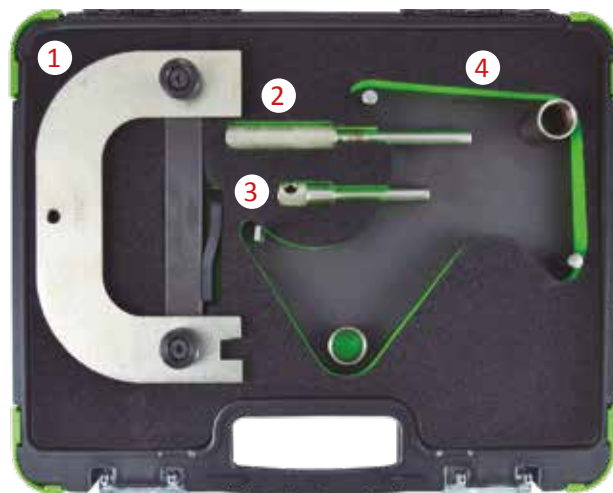

MĂRCI	RENAULT
INSTRUMENTE OEM	MOT1496 (1), MOT1489 (2), MOT861/1863 (3), MOT1490 (4)
CODURILE DE MOTOR	K4J, K4M, F4P, F4R.

KIT DISTRIBUȚIE PE LANȚ RENAULT OPEL 2.2 / 2.5 TDI DCI

N

53292	2,35	2
119,00€	Kg	11

benzină



MĂRCI	RENAULT: Laguna II, Espace, Master, Trafic, 2.2 / 2.5 DCI OPEL: Vivaro, Movano, DIESEL: 2.2 / 2.5 DTI, Astra B, Vectra B, Signum, Zafira, 2.2 16V
INSTRUMENTE OEM	KM6205 (1), KM6204 (2), KM6077 (3)
CODURILE DE MOTOR	2.2 / 2.5

KIT DISTRIBUȚIE PE LANȚ FORD

N

53293	8,90	2	40
133,50€	Kg	11	11

diesel

benzină

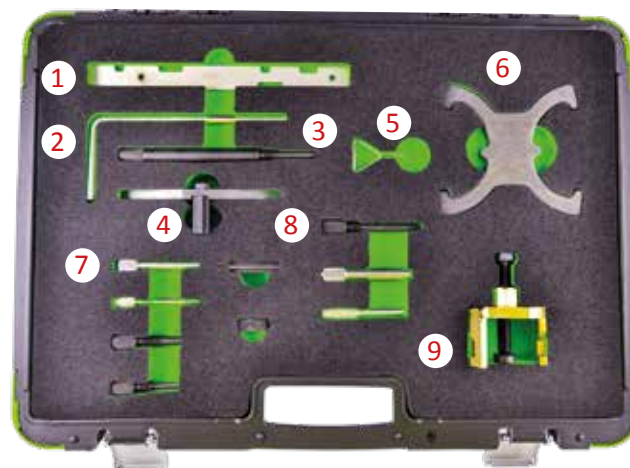

MĂRCI	FORD	B-Max (12-17), C-Max (07-17), Cougar (98-01), Courier (00-02), Escort (94-98), Fiesta (95-17), Focus (98-17), Focus C-Max (03-07), Fusion (02-12), Galaxy (06-15), Grand C-Max (10-17), Kuga (08-15), Maverick (01-07), Mondeo (93-15), Orion (94-94), Puma (97-02), S-Max (06-15), Tourneo Connect (02-15), Transit (06-11), Transit Connect (02-16), EcoSport (13-15), Tourneo Courier (14-15), Grand Tourneo Courier (13-15).
INSTRUMENTE OEM	303-376 (21-162B) (1) / 303-1059 (2) / 303-193 (21-104) (3) / 303-393-01 (4) / 303-1054 (5) / 303-1097 (6) / 303-748 (7) / 303-734 (21-262) (8) / 303-651 (21-229) (9) / 303-393A (21-168) / 303-393-02 / 303-507 (21-210) / 303-620 (21-163) / 303-732 (21-260) / 303-735 (21-263).	
CODURILE DE MOTOR	1.25 16v Curea 1.4 16v Curea 1.4D TDCi Curea 1.5 EcoBoost 1.6Ti-VCT Curea 1.6 EcoBoost Curea 1.6D TDCi Curea 1.6D TDCi ECONetic Curea 1.8 16v Curea 1.8 16v Lanț	1.8D TDCi Curea 1.8D TDDi Curea 1.8D TCI Curea 1.8D Turbo Curea 2.0 16v Curea 2.0 16v Lanț 2.0D TDCi Curea 2.2D TDCi Curea 2.3 16v Lanț

KIT DISTRIBUȚIE PE LANȚ FORD

N

53324

0,30	10	50
Kg	5.6	ft

benzină



MĂRCI

FORD: B-Max (15-17), C-Max (07-10), Cougar (98-01), Fiesta (95-17), Focus (98-11), Focus C-Max (03-07), Fusion (02-12), Galaxy (06-15), Maverick (01-07), Mondeo (93-15), Puma (97-02), S-Max (06-15), Tourneo Connect (02-06), Transit (06-12), Transit Connect (02-06).

MAZDA: 121 ZQ (95-00), 2 DY (02-07), 3 BK (03-09), 3 BL (09-15), 5 CR (05-10), 5 CW (10-12), 6 GG/GY (02-07), 6 GH (07-15), MPV LW (02-05), MX-5 NC (05-16), Tribute EP (04-06).

VOLVO: C30 (06-13), S40 (06-12), S80 (07-11), V50 (04-12).

INSTRUMENTE OEM

FORD: 303-1054, 303-507 (21-210), 303-620 (21-163), 303-574, 303-748, 303-376 (21-162B), 303-376B
MAZDA: 49 JE01 061, 303-574, 49 JE02 061, 303-465, 49 JE01 054
VOLVO: 999 7152, 999 7151.

CODURILE DE MOTOR

1.4 / 1.6

KIT DISTRIBUȚIE PE LANȚ FORD / MAZDA

N

53294

3,70	5	42
Kg	ft	ft

diesel

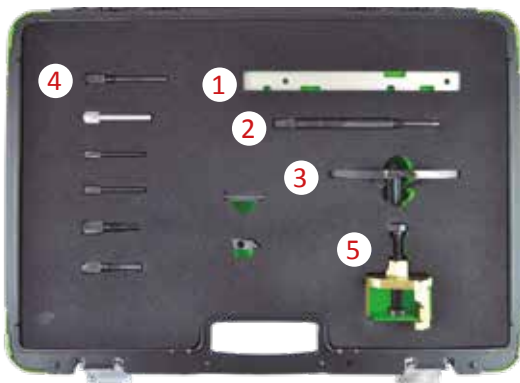

MĂRCI

FORD: Courier (00-02), C-Max (03-10), Fiesta (02-11), Focus (98-11), Fusion (02-11), Galaxy (06-10), Kuga (06-10), Mondeo (07-10), S-Max (06-10), Tourneo Connect (02-13), Transit Connect (02-13)

PEUGEOT: Bipper (08-10) Dispatch/Jumpy III (07-12) Expert III (07-12) Nemo (08-10) Partner I/II (05-11) Partner III (08-16) 107 (05-10) 1007 (05-10) 206 (01-12) 206+ (09-13) 206 CC (05-07) 207 (06-13) 207 CC (07-15) 208 (11-15) 307 (01-08) 308 (07-15) 308 CC (09-15) 407 (05-11) 508 (04-15) 2008 (13-15) 3008 (09-15) 4008 (12-15) 5008 (09-15).

MAZDA: 2 (02-15), 3 (09-14)

CITROËN: C1 (05-10), C2 (03-10), C3 I/II (02-10), C3 III (10-15), C3 Pluriel (04-10), C3 Picasso (09-12), C4 (04-11), C4 II (11-15), C4 Picasso (06-12), C4 Grand Picasso (10-12), DS3 (09-12), DS4 (11-12), DS5 (12-15), C5 II (04-08), C5 III (04-12), Xsara II (02-04), Xsara Picasso (04-10)

INSTRUMENTE OEM

FORD: 303-376B (1), 303-193 (2), 303-393 (3), 303-732 (4), 303-651 (5), 303-393/01, 303-1059, 303-734, 303-735,
MAZDA: 303-732, 303-734, 303-735.
PSA: 0194-A, 0194-C, 0194B.

CODURILE DE MOTOR

1.4D TDCi/Hdi: DV4TD(8HT), DV4TD(8HX), DV4TD(8HZ), DV4TD(8HW), DV4TED4(8HX), DV4TED4(8HV), DV4TED4(8HY), DV4C(8HP), DV4C(8HR), DV4TED(8HS), F6JA, F6JB, F6JC.
1.6D TDCi/Hdi: DV6TED4(9HZ), DV6ATED4(9HX), DV6TED4(9HY), DV6DTE(9HP), DV6C(9HR), DV6CATED(9HX), DV6C(9HL), DV6TED(9HP), DV6ATED(9HY), DV6TED4(9HV), DV6TED4(9HX), DV6C(9HD), DV6C(BHX), DV6C(BHZ), DV6(9HR), DV6BTED4(9HW), DV6DTE(9HJ), DV6ETED(9HN), DV6TED4BU(9HS), DV6BTED4(9HT), DV6BUTED4(9HT), DV6TED4B(9HV), DV6UTED4(9HX), DV6TED(9HD), DV6UTED4(9HU), DV6D(9HP), DV6TE-D4(9HV), DV6C(9HD), DV6TED4(9HW), DV6AT(9HX), DV6ATED(9HX), DV6CTED(9HC), DV6AUTED4(9HX), DV6TED4B, DV6DTE(9HF), HHJA, HHJB, G8DA, G8DB, HHDA, HHDB, MZ-CD, Y6.

1.8D TDCi/Hdi: BHPA, C9DA/B, FFBA, G6DA, G6DB, G6DC, HCPA, HCBP, KKDA, P7PA, P9PA, R2PA, R3PA, RWPA.

1.8d: C9DC, RTN, RTQ.

1.8D Tdi: C9DA/B, C9DC.

2.0D TDCi/Hdi: AZWA, G6DA, G6DB, G6DC, RHE(DW10CTED4), QXWA, QXWB.

SET FIXARE DISTRIBUȚIE PENTRU FORD

51941

2,39	5	180
Kg	ft	ft

148,00€

Acest set permite o corectă aliniere a arborelui cu came și a arborelui cotit pentru schimbarea curelei de distribuție sau a lanțului în motoare pe benzină și diesel.

MĂRCI

FORD

Fiesta / Courier (00-00) Focus(98-00) Focus (04-08) Focus C-Max (03-08) Mondeo (07-08) Tourneo Connect (02-08) Transit connect (02-08), Fusion (02-08) S-Max (06-08) Galaxy (06-08)



KIT DISTRIBUȚIE PE LANȚ FORD 1.8TDDI/TDCI

N

53295	2,10	5
77,00€	Kg	11

diesel

MĂRCI	FORD	C-Max (07-10), Courier (00-02), Fiesta (00-02), Focus (98-11), Focus C-Max (03-07), Galaxy (06-10), Mondeo (07-10), S-Max (06-14), Tourneo Connect (02-13), Transit Connect (02-13).
INSTRUMENTE OEM		303-193 (21-104) (1), 303-393 (21-168) (2), 303-376 (21-162B) (3), 303-652 (21-230) (4), 310-095 (23-067) (5)
CODURILE DE MOTOR		1.8D TDCi: BHBA, F9DA, F9DB, FFBA, FFDA, FFWA, HCPA, HCPB, KHBA, KKDA, KKDB, P7PA, P9PA, P9PB, QYBA, QYWA, R2PA, R3PA, RWPA, RWPC. 1.8D TDCi ECONetic: KHBA. 1.8D Tdi: BHDA, BHDB, BHBA, C9DA, C9DB, C9DC. 1.8D Turbo: C9DC, RTN, RTP, RTQ.

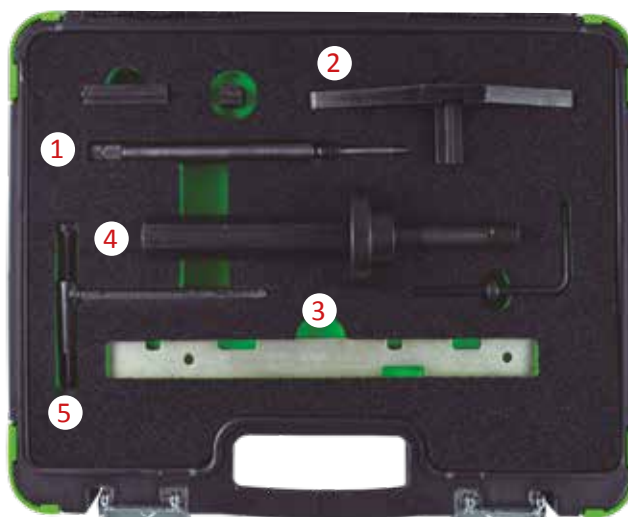

KIT DE DISTRIBUȚIE PT POMPA DE INECȚIE FORD ȘI JAGUAR DURATORQ

N

53296	2,30	5
58,50€	Kg	11

diesel

MĂRCI	FORD: Mondeo (00-07), Transit (00-14). CITROËN: Relay/Jumper III (06-13). FIAT: Ducato (06-11). JAGUAR: X-Type (03-10). PEUGEOT: Boxer III (06-12). LAND ROVER: Defender Td4 (06-11). LDV: Convoy (02-06).
INSTRUMENTE OEM	303-1151 (1), 303-679A/21-238 (2), 303-732 (3), 303-675/21-234 (4), 303-698/21-251 (5)
CODURILE DE MOTOR	12.0D Di/TDdi/TDCi: ABFA, D3FA, F3FA, D5BA, D6BA, F1FA, FMBA, FMBB, HJBA, HJBB, HJBC, HJBE, N7BA, N7BB. 2.2D TDCi/ECONetic: BG, CYFA, CYFB, CYFC, DRFA, DRFB, DRFC, P8FA, P8FB, PGFA, PGFB, QJBA, QJBA (BG), QJBB, QJBC, QJBD, QVFA, QWFA, SRFA, SRFB, SRFC, SRFD, SRFE, UHFA. 2.2D HDi/JTD: P22DTE (4HM), P22DTE (4HU), P22DTE (4HV). 2.4D Di/TDCi: DOFA, D2FA, D2FB, D4FA, F4FA, FXFA, H9FA, H9FB, H9FD, JXFA, JXFC, PHFA, PHFC. 2.4D TD/Tdi: ZSD 424. 2.4D Td4: 244DT.

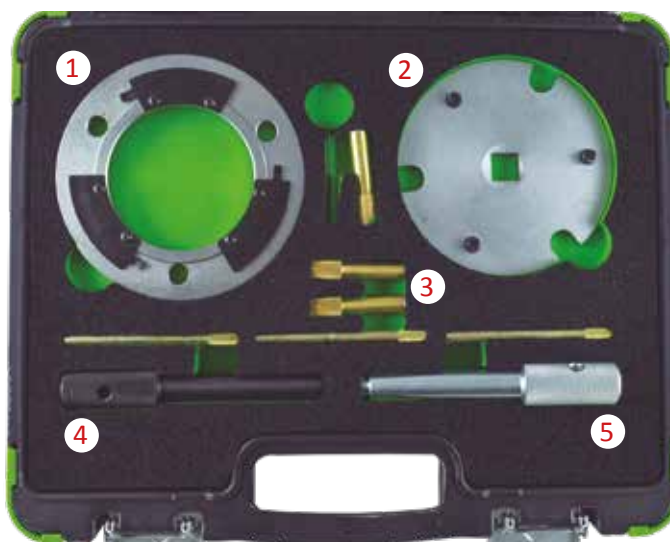

KIT DISTRIBUȚIE PE LANȚ JAGUAR / LAND ROVER

N

53297	1,20	10
44,50€	Kg	11

diesel

MĂRCI	JAGUAR: MS TypeTDVi. LAND ROVER: Discovery 2.7 TDV6. RANGE ROVER: Sport 2.7 TDV6.
INSTRUMENTE OEM	303-1117 (1), 303-1116 (2), 303-1132 (3), 303-1126 (4) (5)
CODURILE DE MOTOR	276DT, 306DT.



KIT DISTRIBUȚIE PE LANȚ LAND ROVER

N

53298

2,60

5

Kg



diesel

80,50€

MĂRCI

MOTOARE DIESEL: 200 TDI. 300 TDI. 2.5

Cutie de transmisie manuală EDC
200 TDI. 300 TDI. 2.5 Motoare diesel
Arborele de deformare a arborelui cotti
Instrument de blocare pentru pompa de injecție
Șurub de sincronizare a pompei de injecție 200/300 TDI
Instrument de sincronizare a motorului 200/300 TWI
Instrument de sincronizare a pompei DPS 2.5
Instrument de sincronizare a volantului motorului 2.5



KIT DISTRIBUȚIE PE LANȚ OPEL / VAUXHALL / CHEVROLET 2.0CDI

N

53300

1,25

10

Kg



diesel

40,00€

MĂRCI

OPEL
VAUXHALL
CHEVROLET

INSTRUMENTE
OEM

EN-48245 (1), EN-48246 (2), 205083060 (3) (4)
(5) (6)

CODURILE DE
MOTOR

DIESEL 2.0 CDI

OPEL / VAUXHALL: Z20DM, Z20DMH
CHEVROLET: LLWZ20DMH, RA 420, Z20SI, Z 20S3,
Z 20S4, Z 20S5

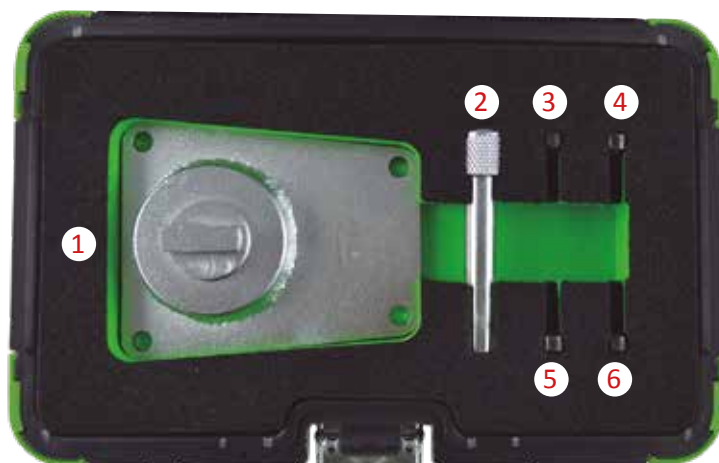

KIT DISTRIBUȚIE PE LANȚ OPEL / VAUXHALL

N

53299

6,70

2

42

Kg



diesel

258,50€

MĂRCI

OPEL/VAUXHALL: MS TypeTDVi.

INSTRUMENTE
OEM

EN-46788 (1), KM927 (2), EN-46789 (3), KM929
(4), EN-46785 (5), EN-46788 (6), 1 860 985
000 (7), KM932 (8), KM933 (9), EN-49978 (10),
KM933 (11)

CODURILE DE
MOTOR

276DT, 306DT.

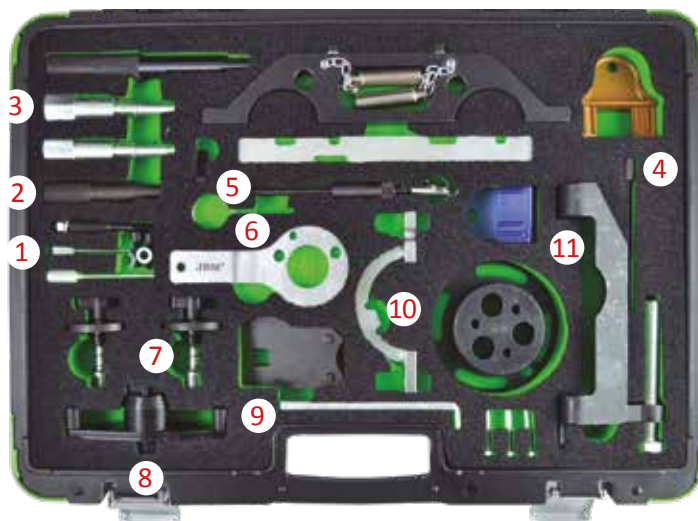

KIT DISTRIBUȚIE PE LANȚ OPEL 1.0 / 1.2 / 1.4



53301	1,15	5
51,00€	Kg	11

benzină

MĂRCI	<u>SUZUKI</u> : Wagon R (05-08). <u>VAUXHALL / OPEL</u> : Agila (00-08), Astra-G (98-06), Astra G Classic II (03-10), Astra-H (04-11), Combo (04-12), Corsa-B (97-00), Corsa-C (00-07), Corsa-D (06-12), Meriva-A (04-10), Tigra-B (04-10).
INSTRUMENTE OEM	KM-953/09919-58310 (1), KM-952/09912-38310 (2), KM-954/09919-08310 (3), KM-6130 (4), KM-955/09919-58320 (5)
CODURILE DE MOTOR	1.0 12v: X10XE, Z10XE, Z10XEP. 1.2 16v: X12XE, Z12XE, Z12XEP. 1.4 16v/ecoFLEX: Z14XEL, Z14XEP.

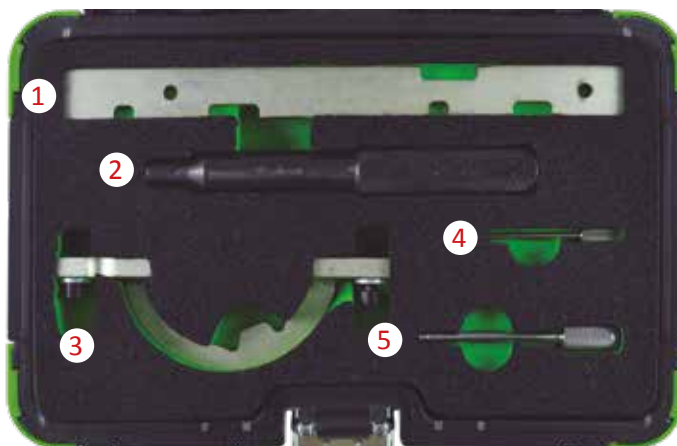

KIT DISTRIBUȚIE PE LANȚ OPEL / VAUXHALL ASTRA, VECTRA, ZĂFIRA 1.9CDTI



53302	1,10	10
46,00€	Kg	11

diesel

MĂRCI	<u>SAAB</u> : 9-3 (04-08), 9-5 (05-08). <u>VAUXHALL / OPEL</u> : Astra-H, Vectra-C, Signum (04-07), Zafira-B (05-07).
INSTRUMENTE OEM	EN46789/32 025 008 (1) (3), EN46788/32 025 009 (2), KM6349 (4)
CODURILE DE MOTOR	Z19DT, Z19DTH, Z19DTL.

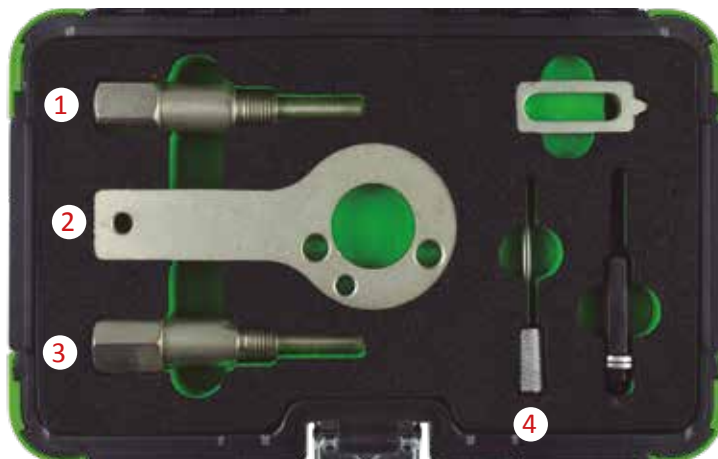

KIT DISTRIBUȚIE PE LANȚ FIAT / OPEL



53303	2	5
130,00€	Kg	11

diesel

MĂRCI	<u>FIAT</u> : 1.9D/JTD (Motoare Peugeot), 2.4D. <u>ALFA ROMEO</u> : 145, 146, 156 JTD. <u>GM</u> : GM 1.3, 1.6, 1.9, 2.0, 2.4 CDTI (2004 -).
INSTRUMENTE OEM	EN-46789 (1), EN-46789-100 (2), EN-46785 (3), EN-46788 (4), EN-46781 (5), EN-46789 (6)
CODURILE DE MOTOR	GM: K1.3 CDTI Z13DT Common Rail engine. 1.9 CDTi / 04-12 - Z19DT Z19DTH Z19DTJ Z19DTL 2.0 CDTi / 08-12 - A20DT LBS / LBX / LBY / LCD.V <u>SAAB</u> : 1.9 TiD.

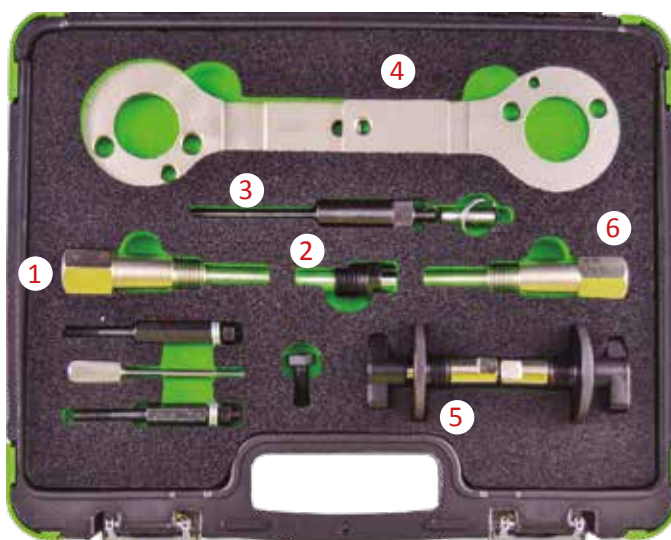

SET FIXARE DISTRIBUȚIE PENTRU OPEL / VAUXHALL

51939	5,75	4	32
416,00€	Kg		

diesel **benzină**

Valabil pentru motoare identice, de exemplu Saab, Renault

DIESEL

1.3 CDTI 16V, 1.9 CDTI, 2.0 DTI, 2.2 DTI

Agila, Astra, Combo-c, Corsa, Frontera, Omega, Signum, Sintra, Tigra, Vectra, Zafira.

BENZINĂ

1.0 12V, 1.2 16V (începînd cu anul 1997)
1.4, 1.6, 1.8, 2.0, 2.2 16V (începînd cu anul 1995)

Agila, Astra, Corsa, Tigra, Frontera, Omega, Sintra, Speedster, Vectra, Zafira.



KIT DISTRIBUȚIE PE LANȚ SAAB / OPEL / VAUXHALL

N

53305	3,60	2	42
130,50€	Kg		

benzină

MĂRCI

VAUXHALL / OPEL: Antara (06-10), Calibra (93-98), Cavalier/Vectra-A (93-95), Omega-B (94-03), Signum (03-05), Sintra (96-99), Vectra-B (95-02), Vectra-C (02-05).
SAAB: 900 (93-98), 9000 (95-97), 9-5 (98-03)

INSTRUMENTE OEM

KM-800-1 (1), KM-800-2 (2), KM-800-20 (3), KM-800-10 (4), 83 95 006 (5), KM-800-30 (6), MKM-6038, 83 95 006 (7)

CODURILE DE MOTOR

2.5 V6: Saab; B2581, Vauxhall/Opel; C25XE, X25XE.
2.6 V6: Vauxhall/Opel; Y26SE.
3.0 V6: Saab; B308E, B308i, Vauxhall / Opel; X30XE.
3.2 V6: Vauxhall/Opel; Y32SE, Z32SE.



KIT DISTRIBUȚIE PE LANȚ FIAT

N

53304	6,00	5	42
240,00€	Kg		

diesel **benzină**

MĂRCI

FIAT

INSTRUMENTE OEM

1 860 874 000 (1), 1 860 895 000 (2), 1 860 898 000 (3), 1 860 905 000 (4), 1 860 845 000 (3)

CODURILE DE MOTOR

MOTOARE BENZINĂ: Fiat Brava, Bravo, Barchetta, Cargo, Coupe, Marea, Palio, Weekend, Punto, Multila, Stilo, Idea, Doblo Twin Cam Engines - 1.2, 1.4, 1.6, 1.8, 16V
MOTORARE DIESEL: Fiat Brava, Bravo, Marea, Weekend, Palio, Punto, Multipla, Doblo, Ulysse, Ducato, Stilo JTD Diesel Engines - 1.9D/TD, 1.9JTD, 2.4TD/JTD.

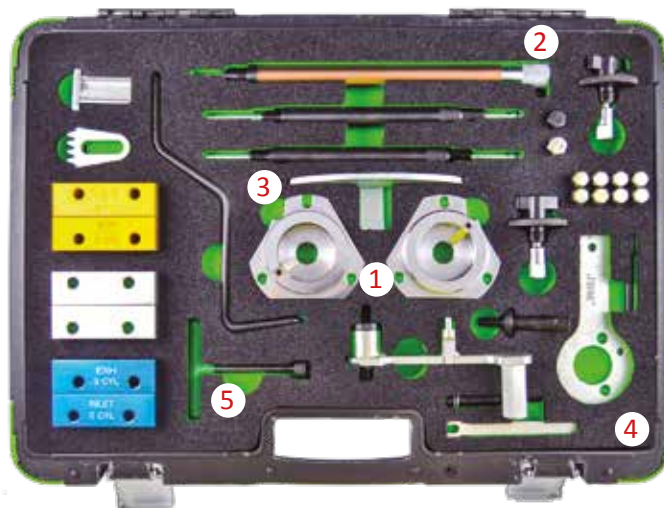

KIT DISTRIBUȚIE PE LANȚ FIAT 1.2 16V

N

53306	1,70	5
54,50€	Kg	1f

benzină

MĂRCI	FIAT: Fiat 1.2L 16V, Fiat Punto / Brava / Bravo / Stilo
INSTRUMENTE OEM	1860992000 (1) (2), 1871000900 (3), 1860987000 (4), 186985000 (5)
CODURILE DE MOTOR	176 B9.000, 182 B2.000, 188 A5.000

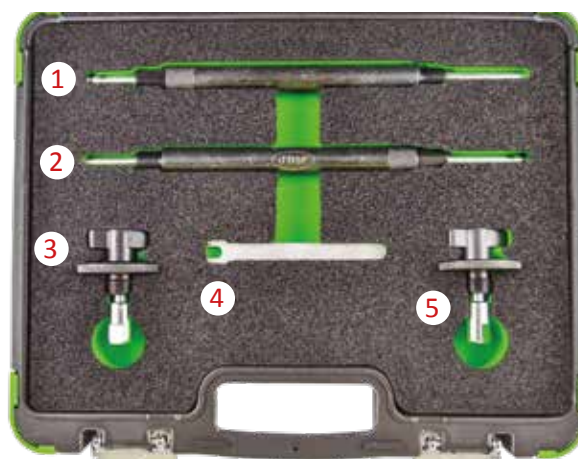

KIT DISTRIBUȚIE PE LANȚ ALFA / OPEL / VAUXHALL 1.6/1.8 16V

N

53307	1	10
38,50€	Kg	1f

benzină

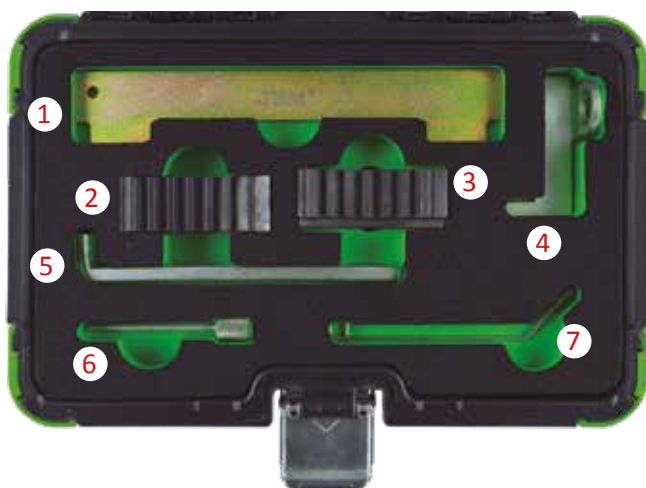

MĂRCI	OPEL / VAUXHALL: Corsa-D, Agila, Astra-G-H, Meriva, Zafira-B, Vectra-C, Signum, Insigna	1.6, 1.8
	CHEVROLET: Aveo, Cruze, Orlando	1.4, 1.6, 1.8
	ALFA ROMEO: 159 FIAT: Croma	1.8
INSTRUMENTE OEM	E10290 (1), 23056-06 (2) (3), E10230 (4), 23164-04 (5), 23174-01 (6), 23056-05 (7)	
CODURILE DE MOTOR	Opel / Vauxhall: Z16LEL, Z16LER, Z16LET, Z16XE1, Z16XEP, Z16XER, A16XER, 18XER, A18XER, 2HO/A18XEL. Chevrolet: G14D, LDD, LXV (F16D4), 2HO(Z18XER). Alfa / Fiat: 939A4.000.	

KIT DISTRIBUȚIE PE LANȚ FIAT / OPEL / VAUXHALL 2.2 16V

N

53316	0,70	20
27,00€	Kg	1f

benzină

MĂRCI	OPEL: Astra-G (2000-2006), Astra-H (2006-2011), Signum (2003-2008), Vectra-B (2000-2002), Vectra-C (2002-2008), Zafira-A (2000-2005), Zafira-B (2005-2012), Speedster (2000-2006). VAUXHALL: VX220 (2000-2006). FIAT: Croma (2005-2009).
CODURILE DE MOTOR	VAUXHALL / OPEL: Z22SE, Z22YH FIAT: 194A1.000.



KIT DISTRIBUȚIE PE LANȚ ALFA ROMEO

N

53308	1,15	10
52,50€	Kg	

benzină

MĂRCI

ALFA ROMEO: 145,146,147,155,156, 1.4 1.6 1.8 2.0 TS, 1.4/1.6 16V; 145/146/147/155/156 (96-10), 1.8 16V; 145/146, (96-01), 155/156 (96-06), Spider/GTV (98-05), 2.0 16V; 145/146 (96-01), 147 (01-10), 155/156 (95-02), 166 (98-07), Spider/GTV (96-05), Purple: 1.4, 1.6 // Albastru: 1.8, 2.0

INSTRUMENTE OEM

1822149000 (1), 1822154000 (2), 1825041000 (3), 1825042000 (4)

CODURILE DE MOTOR

Z1.4/1.6-321.02, 321.03, 321.04, 335.03, 676.01 1.8/2.0-323.01, 672.04, 162.01, 323.10, 671.06, 322.01, 671.02, 322.05, 341.03, 363.01.

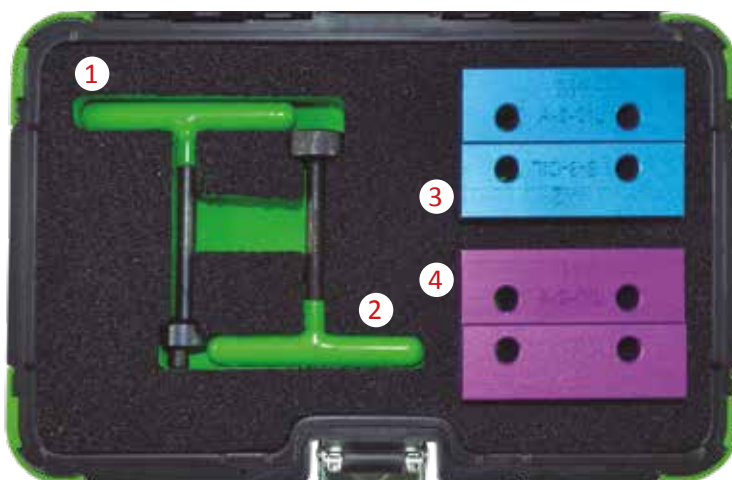

KIT DISTRIBUȚIE PE LANȚ ALFA / FIAT / LANCIA 1.4 / 1.6 / 1.8 / 2.0 16V

N

53309	5,60	2	40
254,00€	Kg		

benzină

MĂRCI

ALFA ROMEO: 145,146,147,155,156, 1.4 1.6 1.8 2.0 TS, 1.4/1.6 16V; 145/146/147/155/156 (96-10), 1.8 16V; 145/146, (96-01), 155/156 (96-06), Spider/GTV (98-05), 2.0 16V; 145/146 (96-01), 147 (01-10), 155/156 (95-02), 166 (98-07), Spider/GTV (96-05), Purple: 1.4, 1.6 // Albastru: 1.8, 2.0
FIAT: Barchetta (96-00), Brava (95-00), Bravo (95-00), Coupe (96-01), Marea (96-00), Marea Weekend (96-00), Punto/Punto Classic (99-06), Stilo (01-08)
LANCIA: Dedra (95-99), Delta (96-99), Kappa (98-02), Lybra (99-06).

CODURILE DE MOTOR

1.4 16v: 335.03
1.6 16v: 321.02, 321.03, 321.04, 372.03, 676.01
1.8 16v: 322.01, 322.05, 671.06, 182A2.000, 183A1.000, 183A6.000, 188A6.000, 192A4.000
2.0 16v: 162.01, 323.01, 323.1, 341.03, 363.01, 672.04
2.0 20v: 175A3.000, 182A1.000, 182B7.000, 185A8.000.



KIT DISTRIBUȚIE PE LANȚ FIAT / ALFA / LANCIA

N

53310	10,70	2	40
425,50€	Kg		

benzină

MĂRCI

ALFA
FIAT
LANCIA

Alla, Barchetta, Bravo, Brava, Coupe, Delta, Dedra, Punto, Spider, GT

INSTRUMENTE OEM

1860845000 (1), 1822154000 (2), 1860905000 (3), 1860992000 (4), 1860895000 (5), 1860874000 (6), 1860985000 (7), KM571A (8), 1 860 896 000 (9), 0153A (10)

CODURILE DE MOTOR

1.2 / 16V, 1.4 / 12V, 1.6 / 16V, 1.6 eco.
1.8, 2.0 / 16V, 2.0 / 20V, 2.4 / 20V, 3.0 / V6.



KIT DISTRIBUȚIE PE LANȚ RENAULT / NISSAN / OPEL / VAUXHALL 2.0 / 2.3 DCI/CDTI M9R/M9T



53311	2,15	5
97,00€	Kg	11

diesel

MĂRCI	<p>NISSAN: Primastar X83 (06-15), Qashqai/Qashqai+2 J10 (07-14), X-Trail T31 (07-14).</p> <p>VAUXHALL/OPEL: Movano-B (10-17), Vivaro (06-15).</p> <p>RENAULT: Espace/Grand Espace IV (06-10), Koleos (08-15), Laguna II (05-07), Laguna III (07-14), Master III (10-15), Megane II (06-10), Scenic/Grand Scenic II (06-09), Scenic/Grand Scenic III (09-15), Trafic II (06-14), Vel Satis (05-10)</p>
INSTRUMENTE OEM	Mot1769 (1), EN-48334 (2), Mot1766 (3), EN-48330 (3), KM-6130 (4), EN-48332 (5), Mot1773 (6), EN-48831 (6)
CODURILE DE MOTOR	<p>2.0D dCi M9R: 630, 780, 782, 784, 786, 788, 830, 832, 833, 834, 835, 836, 838, 855, 856.</p> <p>2.0D CDTI M9R: 630, 780, 782, 784, 786.</p> <p>2.3 Bi-CDTI: LP6/M9T706, LW7/M9T706.</p> <p>2.3D dCi M9T: 670, 672, 676, 678, 680, 686, 690, 692, 694, 698.</p>



KIT DISTRIBUȚIE PE LANȚ FIAT / ALFĂ / FORD



53312	2,60	5
132,00€	Kg	11

benzină

MĂRCI	<p>FIAT: New 500 (07-09), Idea (04-09), Linea (07-09), Grande Punto (07-09), Doblo 1 Cargo (05-09), Panda EV02 (05)</p> <p>FORD: KA 1.2 Duratec (09)</p> <p>ALFA ROMEO</p>
INSTRUMENTE OEM	1 860 987 000 (1), 2 000 004 400 (2), 2 000 015 800 (3), 2 000 004 300 (4), 2 000 004 500 (5)
CODURILE DE MOTOR	<p>1.2: 169A4.000 / 199A4.000 .</p> <p>1.4: 350A 1.000 / 188A4.000-EV02.</p>



KIT DISTRIBUȚIE PE LANȚ CITROËN / PEUGEOT



53313	4,55	2	42
139,00€	Kg	11	11

diesel **benzină**

MĂRCI	<p>CITROËN: AX, BX, Boxer, Berlingo, C25, Dispatch, Evasion, J5, Jumpy, Jumper, Relay, Saxo, Synergie, Visa, XM, Xsara, Xantia, XZ, ZX.</p> <p>PEUGEOT: 106, 205, 206, 305, 306, 307, 309, 405, 406, 605, 607, 806, Expert, Partner, Solara, Talbot.</p>
INSTRUMENTE OEM	7099TM (1), 0188X (2), 0188P (3), 0189AZ (4), 0188H (5), 0132A11 (6), 0189A (7), 0188PM (8), 21-260 (9), 4527-TS1 (10), M8X70 (11), 0188K (12), 0188I (13), 0132Q (14), 4507-TL (15), 4507-TJ (16), 9044-T (17), 4507-TJ (18), 5711-TA (19), 7014-TJ (20), 7017-TR (21), 0188X (22), 7017-TW (23), 7014-TM (24), 0189L (25)

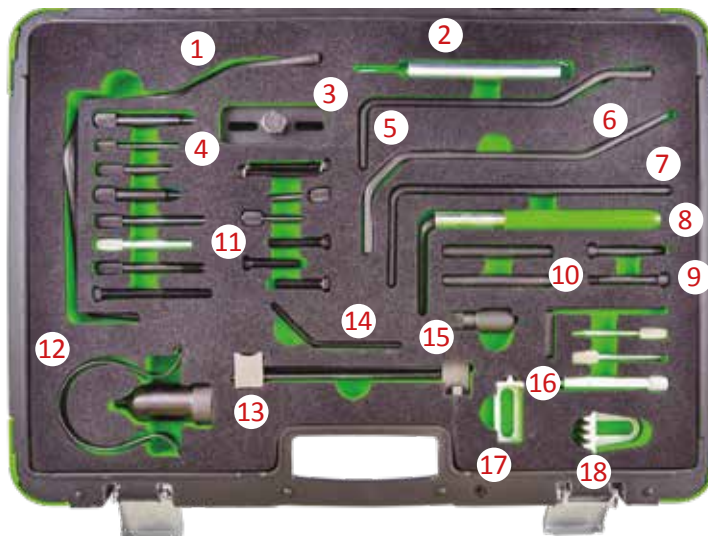

KIT DISTRIBUȚIE PE LANȚ CITROËN / PEUGEOT 1.8 / 2.0

N

53314 1,85 2
90,00€ Kg 11

benzină

MĂRCI

CITROËN: C4 Picasso/Grand Picasso (06-10), C5 II (04-08), C8 (05-10), Dispatch/Jumpy (07-11), Xsara 2.0 16v, C5 1.8/2.0/HPI, Xsara Picasso 1.8/2.0 16v (02-05)
PEUGEOT: 406 1.8 16v (00-04), 407 (06-10), 807 2.0 16v (02-05).

INSTRUMENTE OEM

0189S2 (1), 0188J (2), 0188J2 (2), 0189S1 (3), 21-260 (4), 0189B (5), 0188M (6), 0188AH (7), 0189R (8)

CODURILE DE MOTOR

1.8 16v: EW7A(6FY).
2.0 16v: EW10A(RFJ), EW10ABE4(RFH), EW10J4S (RFK).

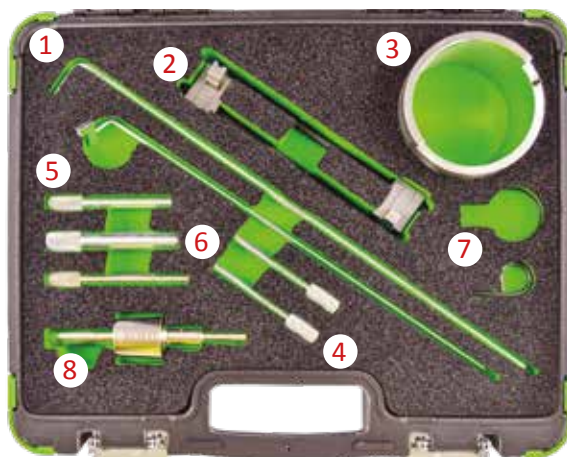

SET FIXARE DISTRIBUȚIE PENTRU CITROËN

51944 4,21 2 64
358,00€ Kg 11



MĂRCI

CITROËN: AX, BX, ZX, XM, Saxo, Xsara, Xantia, Synergie, Evasion, Berlingo, Dispatch, Jumpy, C15, Relay/Jumper, Synergie, C5 (2000-2002), C8
RENAULT

CODURILE DE MOTOR

Motoare benzină: 1.0, 1.1, 1.4, 1.6, 1.8, 1.9, 2.0
Motoare turbo și cu dublu ax de cam: 1.6, 1.8, 2.0, 2.2 16V
Motoare diesel: 1.4, 1.6, 2.0, 2.2 HDi, 1.5D a 2.5D

KIT DISTRIBUȚIE PE LANȚ FIAT / PEUGEOT / CITROËN 2.3D JTD 3.0 JTD/Hd

N

53319 0,60 60 10
31,00€ Kg SUB 11

diesel

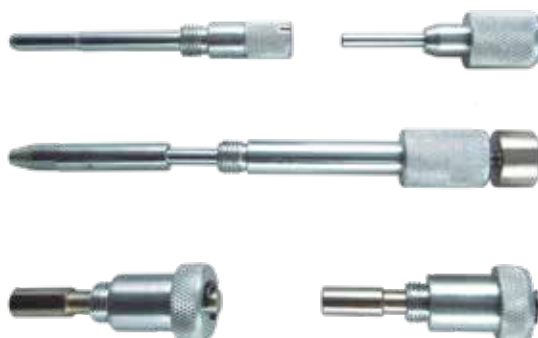

MĂRCI

FIAT: 2.3 / 3.0 JTD.
IVECO: Daily.

INSTRUMENTE OEM

99360614, 1 860 617 000, 99360615, 2 000 018 200.

CODURILE DE MOTOR

F1AE0481C, F1AE0481D, F1AE0481N, F1CE0481A/D.

KIT DISTRIBUȚIE PE LANȚ VOLVO 3.0 / 3.2T6 FREELANDER 2 3.2I

N

53315 71,15 2 42
254,00€ Kg 11

benzină

MĂRCI

VOLVO: S60 (10-16), S80 (07-15), XC60 (08-15), XC70 (06-15), XC90 (10-14), V60 (10-15), V70 (10-15).
LAND ROVER: Freelander II (11-14).

INSTRUMENTE OEM

VOLVO: 999-7263 (3), 999-7264 (1), 999-7272 (5), 999-7257 (2), 999-7261 (4).
LAND ROVER: 303-1225 (3), 303-1226 (1), 303-1219 (2), 303-1223 (4).

CODURILE DE MOTOR

3.0 Turbo: B6304T2, B6304T4.
3.2: B6324S, B6324S5.
3.2i6: B6324S.

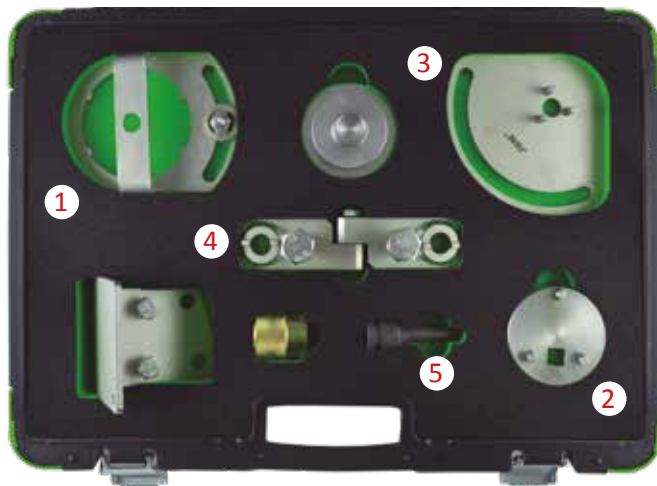

DISPOZITIV DE FIXARE ARBORE CU CAME

51841	0,76	10	120
69,50€	Kg	ff	ff

Rang de deschidere de la 0 până la 60mm



CHEIE UNIVERSALĂ PT. FULII, PINIOANE + ADAPTOARE

51340	2,15	10	200
35,60€	Kg	ff	ff



Conținem:

Chave de Ø 25cm abertura e 52cm de comprimento
4 jogos de 2 parafusos adaptadores de 4 medidas
1 jogo de 2 roscas de Ø 1cm

DISPOZITIV BLOCARE DISTRIBUȚIE

51489	0,37	10	50	2.250
19,10€	Kg	SE	ff	ff

Dispozitiv blocare distribuție VAG, pentru motoare 1.4 și 1.6 16V cu două axe cu came.

MĂRCI	VW	Lupo 99, Polo 95, Caddy 96, Polo Classic, Variant 96, Beetle 1.4L 99, Golf 1.4L, 1.6L 98 y 1.4L, Bora, 1.6L 99
CODURILE DE MOTOR	1.4 / 1.6 16V	



UNEALTĂ ALINIARE ARBORE CU CAME

53322	0,35	10	40
9,00€	Kg	SE	ff

benzină

MĂRCI	VW: Lupo, Polo, Golf IV, Bora. AUDI: A2.
INSTRUMENTE OEM	T10016.
CODURILE DE MOTOR	1.4 / 1.6



EXTRACTOR PINION PT ARBORELE CU CAME FORD

53318	0,40	20
23,00€	Kg	ff

diesel

MĂRCI	FORD
APLICABIL LA MOTOARE	F8M, F8Q, S8U, S9U.



SET BLOCAJ DISTRIBUȚIE UNIVERSAL

51348	0,99	20	150
34,20€	Kg	ff	ff

Colecție de unelte blocaj distribuție cum ar fi: blocaj de arbore, blocaj la motoare cu două axe cu came, diferite blocaje pentru axuri cu came și volantă la motoare.



Conține:

A - O coroană de reglaj de motor și dispozitiv de blocaj
B - Unealtă de blocaj axuri cu came
C - Unealtă de blocaj axuri cu came
D - Unealtă de blocaj axuri cu came

E - Unealtă de blocaj axuri cu came
F - Unealtă de blocaj axuri cu came
G - Unealtă pentru Roată Liberă
H - Unealtă specială de blocaj arbore pentru Volkswagen

UNEALTĂ DE BLOCAJ PT ARBORELE CU CAME GRUP VAG

53320	0,15	10	40
10,50€	Kg	SE	ff

diesel



MĂRCI
SEAT: Alhambra, Altea, Arosa, Cordoba, Ibiza, Leon, Toledo 1.4/1.9/2.0 TDI.
VW: Passat 1.9.
AUDI: A4/A6 1.9.

INSTRUMENTE OEM T10008, T20102, T10100.

TUBULARE DE REGLARE A ARBORELUI CU CAME 1.8 / 2.0 TFSI

N

53323	0,15	18	36
9,00€	Kg	sub	ff

benzină



MĂRCI	AUDI: A3, A4, A5, Q5 1.8. VW: 2.0 Lant.
INSTRUMENTE OEM	T10352, T10352/1.
CODURILE DE MOTOR	1.8 / 2.0

BOLȚURI BLOCAJ MOTOARE PARA RENAULT / OPEL / NISSAN

51488	0,25	20	100	2.250
19,00€	Kg	sub	ff	ff

MĂRCI
RENAULT (diesel): Modus, clio, R19, Megane, Scenic, Express, Rapid, Trafic 1.5 dCi/1.9D/1.9TD/1.9dTi
OPEL: Laguna, Espace
NISSAN: Kangoo, Extra, Express.

INSTRUMENTE OEM
MOT1489, MOT1430, MOT1054.

CODURILE DE MOTOR
K9K, F8Q, F9Q - benzină, Clio, R19, Laguna 1.8/2.0 F3R F3P



TRUSĂ DE FIXARE DISTRIBUȚIE

51482	1,12	20	300
58,00€	Kg	ff	ff



MĂRCI
AUDI: A4, A6, A8, Allroad (97-04)
VW: Passat (98-04)

CODURILE DE MOTOR
AFB, AKE, AKN, AYM, BAU, BCZ, BDG, BDH, BFC

TRUSĂ DE FIXARE SISTEM DE DISTRIBUȚIE

51483	3,88	4	60
238,00€	Kg	ff	ff

Potrivit pentru schimbarea curelelor de la modelele noi și vechi de auto-vehicule 1,9D începând din 1976

diesel

benzină

MĂRCI
AUDI: A4, A6, A8, Allroad (97-04)
VW: Passat (98-04)

CODURILE DE MOTOR
AFB, AKE, AKN, AYM, BAU, BCZ, BDG, BDH, BFC



SET DE CHEI PENTRU TENSOR DISTRIBUȚIE UNIVERSAL

51486	1,37	10	200
107,40€	Kg	ff	ff

Pentru motoare: Alfa Romeo, Fiat, Citroën, Peugeot, Renault, VH

Set de 7 chei pentru tensor distribuție pentru motoare diesel și benzină, compatibilă cu majoritatea tipurilor de motoare.



SET FIXARE DISTRIBUȚIE PENTRU BMW

51485	1,39	16	180
49,00€	Kg	ff	ff

Acest set permite un corect blocaj a sistemului de distribuție pentru motoare MMN, M47 2.0 16

Motoare: (E469), 318D, 320D, 330D, (E39), 520D, 525D, 530D, (E38) y 730D



SET FIXARE DISTRIBUȚIE PENTRU SEAT / AUDI / VW / SKODA

51487

250,00€

Kg	4
ff	5
	60

diesel

benzină



Include instrumente pentru schimbarea curelei de distribuție în modele de autovehicule noi și de autovehicule mai vechi 1,9D începând din 1976.

MĂRCI AUDI: A4, A6, A8, Allroad (97-04)
VW: Passat (98-04)

CODURILE DE MOTOR AFB, AKE, AKN, AYM, BAU, BCZ, BDG, BDH, BFC

UNEALTĂ DE SINCRONIZARE A FULIILOR VW AUDI 2.5 TDI 32MM

53325

5,50€

0,10	20	100
Kg	sub	ff

benzină



MĂRCI AUDI
VW

INSTRUMENTE OEM 3355

CODURILE DE MOTOR AAB, AAT, ACU, ACV, AEL, AET, AGX, AHG, AHY, AJA, AJT, ANJ, APA, APL, AUF, AVT, AXG, AXL, AYC.

SET BLOCAJ DISTRIBUȚIE VAG

52271

19,00€

0,43	5	40	320
Kg	sub	ff	



MĂRCI

AUDI: A2 1,4TDI (02-06), A3 1.9, 2.0TDI (02-08), A4 1.6TDI (02-05), A4 1.9, 2.0TDI(04-08), A6 1.9TDI (02-05).
SEAT: Altea 1.9SDI/TDI (05-08), Leon 1.9, 2.0TDI (05-08), Toledo 1.9SDI/TDI (05-08).
SKODA: Fabia 1.4TDI (03-06), Octavia II 2.0TDI (03-06)
VW: Beetle 1.9TDI (02-08), Bora 1.9TDI (02-08), Fox 1.4TDI (02-08), Golf 1.9, 2.0TDI (02-08), Lupo 1.4TDI (02-08), Polo 1.4, 1.9TDI (02-08), Sharan 1.9TDI (02-08).

CODURILE DE MOTOR

AUDI: AMF, ASZ, ATD, AVB, AVF, AWX, AXR, AZV, BHC, BKC, BKD, BKE, BLB, BMN, BNA, BPW, BRB, BR, BRD, BRE, BRF, BUY, BVA, BVF, BVG.
SEAT: BJB, BKC, BLS, BMM, BXE
SKODA: AMF, AZV, BKD
VW: AJM, AMF, ANU, ARL, ASZ, ATD, AUU, AVB, AVF, AWX, AXR, BAY, BMS, BNM, BNV, BWB

UNEALTĂ PT REGLAREA TENSIUNII CURELEI VAG

53321

9,50€

0,25	10	50
Kg	sub	ff

benzină



MĂRCI

AUDI: A4/1.8T, 2.0 1999-2004 A6/1.8T 2002-2004 A4/3.0 (2002 -), A6/3.0 (2002 -), A8/7.0 (2003 -).
VW: Golf Passat 2.0 TDI DIESEL, Golf 88-97, Passat 92-97, VW T4/2.0 1992-2004.

INSTRUMENTE OEM T10020.

CODURILE DE MOTOR

F1AE0481C, F1AE0481D, F1AE0481N, F1CE0481A/D.

CHEIE TENSOR CUREA DISTRIBUȚIE SPECIAL BMW MINI COOPER

51135

63,70€

1,56	10	400
Kg	ff	

Special pentru Mini Cooper motor S/W11



UNEALTĂ PT REȚINERE POMPĂ ANTICONGELANT

53317

28,00€

0,64	12
Kg	ff



benzină

MĂRCI OPEL 2.2 VAUXHALL 2.2



TUBULARĂ 1/2 PENTRU PRECAMERĂ COMPRESIE MOTOARE DIESEL MERCEDES

52819

23,80€

0,24	5	72
Kg	sub	ff



1/2"

MERCEDES

58 DINȚI





10



ACCESORII LUBRIFIANTE

REZERVOR DE ÎNMAGAZINARE	187
CĂRUCIOR PENTRU TRANSPORTAT	
BIDOANE	188
COLECTOR DE ULEI	188
POMPĂ PENTRU EXTRAȚIE	189
POMPĂ	191
TAVĂ PENTRU LICHIDE	191
PĂLNII	192

REZERVOR DE ÎNMAGAZINARE PENTRU BIDOANE

OMOLOGAT DIBT / Husă detașabilă / Palet fix pentru scurgeri / Scoateți bidonul înainte de a utiliza un stivuior / Transport ușor.

Suporta 400 kg

52804	18,50	1	5
244,00€	Kg		

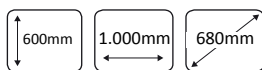

1 BIDON VERTICAL

230L



Suporta 650 kg

52805	31	1	5
290,00€	Kg		

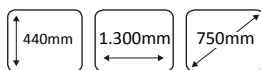

2 BIDOANE VERTICALE

250L



Nu este adecvat pentru palet
Suporta 1.250 kg

52806	30	1	5
465,00€	Kg		

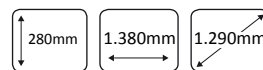

4 BIDOANE VERTICALE

250L



HOMOLOGAT DIBT

SUPORTURI PENTRU ÎNMAGAZINARE PENTRU 2 BIDOANE



53214	16,50	1	12
225,00€	Kg		

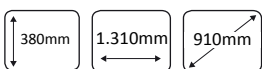

Pentru 2 bidoane

Compatibil cu Euro palet (1200 mm x 800 mm) și palet din plastic cu dimensiuni similare

Coșurile pentru transport și depozitare economică

Poate fi utilizat cu gratar sau plasați euro paletul direct deasupra cupei, pentru a reduce costurile

Paletii încărcati pot fi plasati în / scosi din batal, cu sau fără grilă de stivuior

Grilă cu orificii de inspecție și deschideri pentru mâini și pompe

Cubeto cu o înălțime mai mică potrivită pentru munca

Abilitatea online sau a standardelor europene, britanice și americane

Pot fi manevrate de stivuior sau paletă 4 laturi pe 2 laturi cand sunt goale

Fabricat din polietilenă. - 100% reciclabil



CONTAINER IBC 1.000L

52807	82,50	1	1
1.199,00€	Kg		

1260L

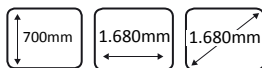

Suporta 2.500 kg



Pot fi stivuite, economie de spațiu, inovatoare

Înălțime redusă (700mm) pentru ușurință în utilizare

Suprafață de lucru larg (2,5 m²)

Platformă cu acces la mâini și cu găuri pentru inspecție și de inserare a pompelor

Transport ușor.

Fabricate din polietilena (PE) 100 % reciclabil

HOMOLOGAT DIBT

CHEIE PLASTICĂ PENTRU BIDOANE

52452	0,12	6	60	1.080
6,80€				

Material: Nailon

Împotriva scânteilor și împotriva prafului

Reliefuli terminate de 3/4" și 2"

Utilă pentru bidoane de 200l



ROBINET PENTRU BIDON DE 1000L

53078	
14,10€	

	0,25
	5
	25
	300



ROBINET PT. BIDON DE ULEI DE 3/4"

52453	0,19	5	100	1.000
17,00€				

Robinet de siguranță

Filet de 3/4"

Corp din aliaj

Garnitură de Nailon

Aplicații: Uleiuri, lubri-

fianți,

benzină, diesel, kerosen,

etc.

Valabil pentru ADBLue



CĂRUȚIOR PENTRU TRANSPORTAT BIDOANE SP. GRESARE

50924	31	1	7
250,70€			

Adecvat pentru bidoane de ulei de 200 l.



ROATĂ GIRATORIE



11321	ROATĂ GIRATORIE	11320	JOC DE ROȚI LATERALE FIXE
18,23€	PENTRU REF. 50924	12,56€	PENTRU REF. 50924

COLECTOR DE ULEI

N

53223	26	1
366,30€		

Nivelul de vid: 0-0,8 bar negativ.

Presiunea de lucru: 6-8 bar

Capacitatea de recuperare a uleiului: 10L

Capacitatea containerelor de depozitare: 75L+10L+5L

Greutate netă: 29 kg

Viteza de aspirație: 0,6l / min (5 mm) 1,6l / min (8 mm)



5L

10L

75L

COLECTOR DE ULEI

53109	19,50	1	6
266,00€			

80L

1,02m - 1,65m	500mm	400mm
---------------	-------	-------

Caracteristici:

Capacitate suplimentară de 10 litri în colecția strecurătoare.

Înălțime reglabilă de colectare: 1m. min / 1.65m max.

Bază cu 2 roți fixe și 2 ruedasmobiles.

Inclusiv mâner care transportă.

Furtun de scurgere din cauciuc 130cm con mango.

Aer de admisie ¼" pentru a facilita elvaciado datorită presiunii.

Supapă de siguranță inclusă.



5L

75L

HOSE DE ÎNLOCUIRE PENTRU REF. 53223

14014	4,10€	4mm
14015	4,40€	6mm
14016	4,90€	8mm

PIULIȚĂ PENTRU POMPA DE ULEI PENTRU REF. 50935 ȘI 50918

10767	0,28	90
21,00€	Kg	ff



10925	0,67	90
18,00€	Kg	ff



POMPĂ DE ULEI PNEUMATICĂ

52601	8,95	2	30
303,50€	Kg	ff	ff

PRESIUNE Raport: 5: 1
Intrare aer: 1/4"
Ieșire aer: 1/2"
PRESIUNE lucru: 6 - 8 bar
PRESIUNE Max.: 8 bar
Consum de Aer : 250 L/min
Capacitate relativă 6 bar: 18 L/min
Temperatură ulei: -10~50 °C
Vâscozitate maximă: 240 SAE
Lungimea tubului: 950mm



200L

12056 FURTUN CU ROBINET
44,50€ REF. 52601

KIT POMPĂ DE ULEI + FURTUN + PISTOL ULEI DIGITAL

50935	10,70	1	20
495,00€	Kg	ff	ff

Presiune Raport : 5: 1
Intrare aer : 1/4"
Ieșire aer : 1/2"
Presiune de lucru : 6 - 8 bar
Presiune Max. : 8 bar
Consum de aer : 250 L/min
Capacitate relativă 6 bar : 18 L/min
Raport de Temperatură ulei : -10~50 °C
Vâscozitate maximă : 240 SAE
Lungimea furtunului : 2 m
Lungimea tubului : 950 mm



POMPĂ MANUALĂ PENTRU EXTRAȚIE ULEI

51253
35,40€

Kg	2,06
ff	10
ff	180

1.400mm

515mm



POMPĂ DE ULEI PNEUMATICĂ

50918
265,70€

Kg	7,25
ff	1
ff	34

200L

Presiune Raport : 5: 1
Intrare aer : 1/4"
Ieșire aer: 1/2"
Presiune lucru : 6 - 8 bar
Presiune Max. : 8 bar
Consum de Aer : 250 L/min
Capacitate relativă 6 bar : 18 L/min
Temperatură ulei : -10~50 °C
Vâscozitate maximă : 240 SAE
Lungimea tubului: 950mm



PISTOL DE MĂSURARE DIGITAL

50917	2,15	10	50
253,70€	Kg	ff	ff

1,4KG

Intrare aer : 1/2"
Raport de Debit : 1-35 L/min
Presiune de lucru : 6 - 8 bar
Raport de Temperatură a uleiului :
-10~60 °C
Vâscozitate maximă : 240 SAE
Greutate : 1,4 kg



BATERII INCLUSE

10000 **145,00€**
MANOMETRU
PISTOL DIGITAL
P/50917

POMPĂ PNEUMATICĂ DE ULEI CU FIXARE PE PERETE CAP. 1000L

51058	4,68	1	10
497,00€	Kg	ff	ff

Furtun de 2 m inclus.
Relație de compresie / 5: 1
Conexiune intrare aer / 1/4"
Conexiune ieșire ulei / 1/2"
Capacitate ulei 6 bar
(ieșire liberă) l/min. 14
Presiune exerciți bar 6-8
Presiune max. consensuală bar 8
Diametru tub aspirator mm 42 la perete
Consum aer l/1'250
Nivel zgomot dB 81
Temperatură ulei °C -10+50
Maximă vâscozitate ulei SAE 240
Adecvat pentru lemn de kg 180- 220 la perete
Greutate kg 5,1
Lungime tub rezervor mm 270
Lungime furtun rezervor mm 2 000



KIT POMPĂ UMPLERE ULEI

52797

238,00€

5	2	16

Capacitate: 7,5L
Descărcare: 80cc cicluri
Raport de vâscozitate:
Până la SAE 140



CAPACITATE DE
DESCĂRCARE

13234 169,10€

POMPĂ UMLERE ULEI
FĂRĂ ACCESORII
REF. 52797

SET ADAPTOARE P/52797

12044

134,90€

1,32	20	120

15
PCS



101
FORD 1/8 - 27 (NPT)

105
VW/AUDI, MINI COOPER
M10x1.0

109
VW/SKODA M18x1.5

113
TOYOTA, LEXUS M18x1.0

102
UNIVERSAL, BMW,
HONDA, NISSAN etc

106
VW/AUDI DSG M24x1.5

110
AUDI/VW, SKODA, M30x1.5

114
NISSAN, INFINITY M8x1.0

103
VW/AUDI, SKODA

107
VW/AUDI CVT M22x1.5

111
UNIVERSAL FLEXIBLE 300mm,
HONDA, HYUNDAI, KIA etc

115
ATF - ADAPTER VW PASSAT

104
VW/AUDI, PORSCHE

108
MERCEDES M12x1.5

112
VOLVO 5/16 - 24 (UNF)

POMPĂ MANUALĂ EXTRACȚIE GASOIL

52789

14,10€

0,15	10	100	600



Furtun 90cm lung la fiecare capăt

POMPĂ MANUALĂ DE EXTRACȚIE DIN PLASTIC

52329

32,00€

0,98	10	140

Pentru bidoane de 25, 50 și 200L

350ml pe pompare

Corp și piston de polipropilenă

Mâner din plastic ABS

Aplicații:

Alcooli, uleiuri, lubrifianți, benzină, diesel,
kerosen, etc

Valabil pentru ADblue

Conductă de aspirație:

Lungime minimă de 320mm

Lungime maximă de 900mm



POMPĂ MANUALĂ DE EXTRACȚIE

52428

43,10€

	1,39
	1
	10
	120



Pentru bidoane între 50 și 200 litri //

Debit 400ml pe impuls

Aplicații: Uleiuri, lubrifianți, diesel, kerosen, etc.

Valabil pentru ADBlue.

Recomandat pentru: acetona, antigel, lichid de frână, detergenți, glicerină, erbicid, acizi
ușori, fluide pe bază de ulei

Capacitate de pompare: 37litri x minut

Adaptor de gură de 2" inclus

Conductă de aspirație de 101cm cu intrare de 1 1/4" și ieșire de 1

Nu este permis pentru: acizi tari, benzină, leșie

ROLĂ AUTOMATĂ CU FURTUN PENTRU ULEI DE 1/2"

50797	26,60	1	14
425,60€	Kg	ff	ff

Suport/rolă pentru ulei
Lungime: 15m
Capăt de 1/2"

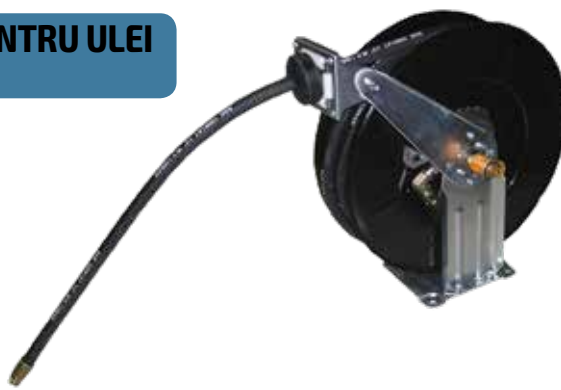

POMPĂ MANUALĂ TRANSPARENTĂ

52498	0,86	6	126
48,30€	Kg	ff	ff

1.500cc

Fabricată din polipropilen. Corp transparent
Utilă pentru uzul de uleiuri de transmisie și diferențiale
Rezistentă la lichid de frână și antigel



11867 9,00€

DOUĂ ORINGURI DE SCHIMB PENTRU REF. 52498

POMPĂ DE GREȘARE PNEUMATICĂ

50751			
29,40€	Kg	ff	ff

1,50	10	150
------	----	-----

500cc

Presiune : 30 Mpa

INCLUDE

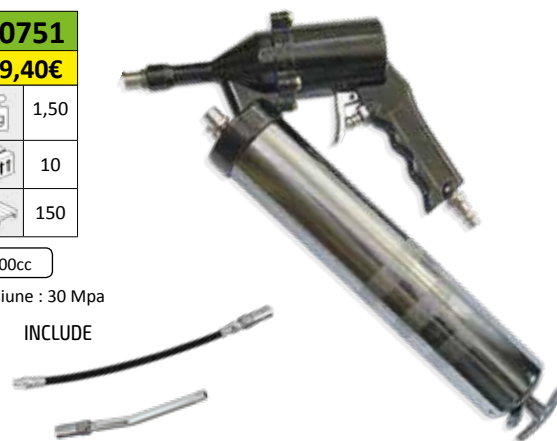

POMPĂ MANUALĂ TRANSPARENTĂ

52628	0,30	5	50	450
26,50€	Kg	sub	ff	ff

200cc

Adecvată pentru utilizarea în lichid de frână
Conector rapid într-un extrem



TUB FLEXIBL

POMPĂ DE GREȘARE MANUALĂ

50852	1,30	20	280
22,00€	Kg	ff	ff

Țeavă rigidă.
Țeavă flexibilă.
Presiune : 20 Mpa

500cc

INCLUDE



SERINGĂ TRANSFER DE ULEI

51928	0,82	5	20	360
12,00€	Kg	sub	ff	ff

500cc



CHROME



TAVĂ DIN OȚEL PENTRU LICHIDE

51356	2,39	10	64
38,00€	Kg	ff	ff

20 L

100mm

350mm

550mm



TAVĂ DIN PVC 15L

PENTRU ANTIGEL

51876	0,96	4	32
19,00€	Kg		

PENTRU ULEI

51132	0,83	4	32
19,00€	Kg		



Tavă din PVC pentru ulei, capacitate 15 litri, culoare verde. Sistem de golire lateral
Mâner pentru manipulare. PVC foarte rezistent. Compact. **Dimensiune:** 140mm
alto / **Diametru:** 400mm

ULEI COLECTOR 18L

PENTRU ANTIGEL

53215	0,95	8	32
14,80€	Kg		

PENTRU ULEI

53144	0,99	8	64
14,00€	Kg		



N



JAR CU GÂT FLEXIBI

2L	5L
52991	52992
6,45€	11,60€
0,16	0,36
20	16
240	96



PÂLNIE PENTRU BIDON DE 200L CU CAPAC ȘI FILTRU

N

53187	0,75	1	18	54
23,45€	Kg			

4,5L

Ø Interior: 245mm
Ø Exterior: 255mm



FILTRU



POMPĂ MANUALĂ PENTRU ULEI 250ml



52243
6,00€
0,17
10
60
720

250ml

POMPĂ MANUALĂ PENTRU ULEI 500ml

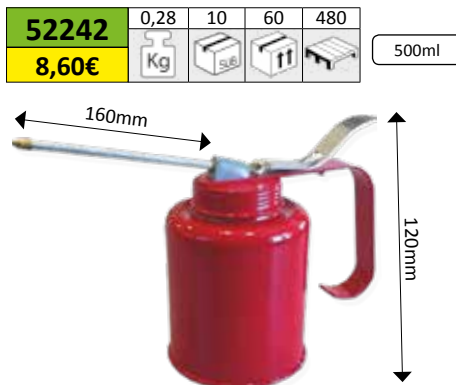

52242	0,28	10	60	480
8,60€	Kg			

500ml

SET DE 3 PÂLNII

N



53188	0,15	24	288
3,90€	Kg		

90mm
Ø 130mm
180mm

PÂLNIE CARBURANT

52391
9,00€
0,09
20
400



950ml

140 x 15mm

SET 2 PÂLNII CARBURANT MINI

52392	0,07	100	800
7,00€	Kg		



5,5 x 13 / 4,5 x 13mm

PÂLNIE CU TUB FLEXIBIL

53198	0,15	24	168
6,35€	Kg		



530mm

1,89L

Ø 180mm



11



INSTRUMENTE HIDRAULICE

CRICURI HIDRAULICE	194
CRIC HIDRAULIC	196
CRIC PENTRU	196
SUPORT DE SUSȚINERE	197
PURTĂTOR HIDRAULIC	197
PRESE	197
MACARALE PLIABILE	198
SUPORȚI PENTRU MOTOR	198
RAMPE	199
PENTRU MOTOCICLETE	200
TRANSPALET	201

CRIC HIDRAULIC 3 T CU PEDALĂ

53112	39,95	1	18
174,00€	Kg		

Min: 140mm
Max: 520mm



720 x 345 x 185mm



13853 93,00€

PISTON HIDRAULIC
PENTRU CRIC REF. 53112

CE

CRIC HIDRAULIC TIP CROCODIL

50818	37,35	1	18
156,00€	Kg		

Min: 145mm
Max: 500mm



685 x 346 x 180mm



10768 112,00€

PISTON DE SCHIMB
PENTRU CRICUL
CU REF. 50818

10770 6,00€

ARC CRIC PENTRU
CRICUL CU REF. 50818

10639 10,90€

ȘURUB DE FIXARE
LATERAL PENTRU
CRICUL CU REF. 50818

10769 18,00€

SUPPORT PENTRU
CRICUL CU REF. 50818

EN 1494:2001 CE

CRIC HIDRAULIC TIP CROCODI

50817	10,75	1	18
164,00€	Kg		

Min: 120mm
Max: 505mm



490 x 205 x 140mm



CE

10682 88,00€

PISTON DE SCHIMB PENTRU
CRIC CU REF. 50817

10683 4,00€

ARC DE AGĂȚARE PENTRU CRICUL
CU REF. 50817

CRIC HIDRAULIC TIP CROCODIL

50815	10,75	1	56
48,00€	Kg		

Min: 130mm
Max: 355mm



490 x 205 x 140mm



11939 48,00€

PISTON HIDRAULIC
PENTRU CRIC REF. 50815

CE

CRIC HIDRAULIC TIP CROCODIL SPECIAL MAȘINI JOASE



53421	-	1	-
224,55€	Kg		

Min: 75mm
Max: 505mm



740 x 360 x 150mm



CRIC HIDRAULIC DE CU PEDAL DE RIDICARE



53422	-	1	-
305,20€	Kg		

Min: 100mm
Max: 533mm



778 x 372 x 165mm



CRIC HIDRAULIC TIP CROCODIL SPECIAL MAȘINI JOASE

50816	59,00	1	56
59,00€	Kg		

Min: 85mm
Max: 375mm



560 x 212 x 145mm



11940 37,50€

PISTON HIDRAULIC
PENTRU CRIC REF. 50816



CRIC HIDRAULIC TIP CROCODIL CU MÂNER ROTATIV 360°

51903	20,00	1	42
126,60€	Kg		

Min: 120mm
Max: 420mm



651 x 705 x 175mm



CRIC HIDRAULIC TIP CROCODIL ÎN CUTIE PLASTICĂ

51895	11,68	1	42
58,00€	Kg		

Min: 130mm
Max: 355mm



490 x 205 x 140mm



CRIC FOARFECĂ



53218	2,50	6	216
17,60€	Kg		

Min: 85mm
Max: 360mm



Potrivit pentru toate
automobilele.



CRICURI HIDRAULICE 2 - 15T

Min: 181mm Max: 345mm

50819	2,43	6	288
17,90€	Kg		



Min: 194mm Max: 372mm

50820	3,22	6	270
22,00€	Kg		



Min: 216mm Max: 413mm

50821	4,22	5	200
31,30€	Kg		



Min: 230mm Max: 460mm

50822	5,79	4	160
41,70€	Kg		



Min: 225mm Max: 365mm

52304	7,59	2	112
57,50€	Kg		



CE

CRICURI HIDRAULICE ÎN CUTIE DIN PLASTIC

Min: 185mm Max: 340mm

51905	2,76	6	144
20,90€	Kg		



Min: 195mm Max: 385mm

51906	3,58	4	144
26,40€	Kg		



Min: 215mm Max: 450mm

51907	4,74	4	96
33,40€	Kg		



CE

CRIC HIDRAULIC 20T

50823	10	2	112
67,10€	Kg		



Min: 242mm Max: 452mm



CE

CRIC HIDRAULIC 20T MAȘINI JOASE

50824	8,35	2	96
64,40€	Kg		



Min: 190mm Max: 335mm



CE

CRIC HIDRAULIC 30T

50825	13,76	2	72
101,30€	Kg		



Min: 285mm Max: 465mm



CE

CRIC PENTRU CUTII VITEZE

50830	42,15	1	6
399,00€	Kg		



Min: 850mm
Max: 1.740mm

Cu handgrip
Rapid
Dublu piston

12046 274,00€
PISTON DE SCHIMB
PENTRU REF. 50830



CE

CRIC PENTRU CUTII VITEZE 0,5T



53161	33,5	1	4
188,00€	Kg		

Min: 113cm
Max: 191cm

90cm

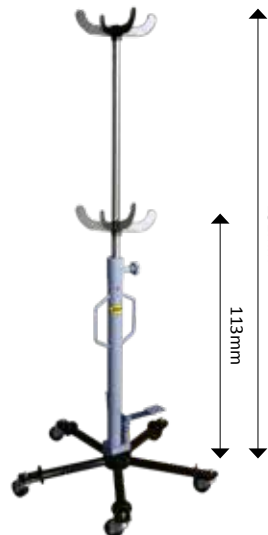

Ulei sae 40. Cu o construcție solidă și sistem hidraulic de înaltă calitate.

Cu pedala pentru o utilizare ușoară și rapidă.
5 roți pentru o stabilitate mai bună



SET DE 2 SUPORȚI SUSȚINERE CAROSERII

50832
33,00€

7,31	1	60
Kg	ft	in

Min: 288mm
Max: 423mm



50833
78,00€

16,25	1	25
Kg	ft	in

Min: 390mm
Max: 608mm



195mm
170mm



PURTĂTOR HIDRAULIC ROȚI AUTO SPECIAL PENTRU ROȚI DE CAMION

52241

754,00€

Kg	142,50
ft	1
in	4

Lungimea totală: 1.270mm
Lățimea totală: 760mm
Înălțime totală: 2.150mm



13705 **445,00€**

PISTON PENTRU
REF. 52241



SUPORȚI DE SUSȚINERE DE ALUMINIU PENTRU CAROSERII



53200
126,80€

4,70	1	72
Kg	ft	in

2
PCS



Min: 245mm
Max: 385mm



PURTĂTOR HIDRAULIC ROȚI AUTO

51901

495,00€

Kg	75,50
ft	1
in	6



Lungimea totală: 1.090mm
Lățimea totală: 1.040mm



PRESĂ HIDRAULICĂ DE 12T

50812

290,00€

Kg	56
ft	2
in	20

Suprafață de lucru: 480mm

130 x 56 x 56cm



PRESĂ HIDRAULICĂ 20T

50813

399,00€

Kg	80,50
ft	1
in	12

Gamă de lucru:
0-988mm
Stroke: 190mm
Suprafață de lucru:
450mm

150 x 58 x 56cm

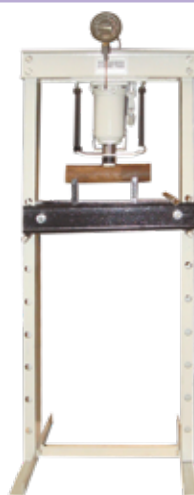

PRESĂ HIDRAULICĂ 30T

50814

680,00€

Kg	117,50
ft	1
in	6

Gamă de lucru:
310 - 1.150mm
Stroke: 130mm
Suprafață de lucru:
700mm

160 x 71 x 65cm



MACARA PLIABILĂ DE 1T

52985	74	1	16
354,00€	Kg	ff	ff

Min: 85mm
Max: 2.200mm

1T
1460 x 1460mm



Max . încărcare: 1,25T
Gama de ridicare: 70-160mm
Boom Gama de extensie: 81-105
Accident vascular cerebral ram:460mm
Mărimi: 1460x1460mm
Lungimea de bază: 1460mm
Lățime de bază: 970mm

CE

MACARA PLIABILĂ DE 2 T.

50831	81,40	1	20
295,00€	Kg	ff	ff

Min: 60mm
Max: 2.620mm

2T

1.750 x 1.060 x 1.460mm

Gama de ridicare:
1'80m (2T) - 2,19m (½T)



Dimensiuni de desfacere:
1.750x1.060x1.460 mm
Dimensiuni pliabilitate:
800x680x1.600 mm
Capacitate Maximă 2 Tone
în poziția 1: 2 Tone
în poziția 2: 1½ Tone
în poziția 3: 1 Tona
în poziția 4: ½ Tone

12032 7,50€
ROATĂ GIRATORIE MARE
PENTRU ELEVATOR 50831

11323 16,00€
SET DE ȘURUBURI
PENTRU REF. 50831

CE

BAZĂ PENTRU PRESĂ

52999	7,60	2	120
144,00€	Kg	ff	ff

BLOC MARE

BLOC MICI

200 X 250 X 40mm

200 X 70 X 40mm



MAȘINĂ HIDRAULICĂ DE ÎNDOIT ȚEAVĂ

50835	32,45	1	12
272,00€	Kg	ff	ff

12T
68 x 58,5 x 18,5mm

Construit din oțel robust capabil de a îndoi țevi de până la 2" (50mm)
Bare de îndoire reglabile pentru a se potrivi la distanța dorită.

Presiunea aerului: 0,75 - 0,75mpa

Dimensiunea penei:

1/2", 3/4", 1", 1/4", 1-1/2", 2"

CONCEPUT PENTRU UTILIZARE
ORIZONTALĂ ȘI VERTICALĂ



CE

SUPORT PENTRU AGĂȚAT MOTOARE

50631	6,22	1	98
60,00€	Kg	ff	ff

750Kg



CE

SUPORT PENTRU RIDICAT MOTOARE

51452 31,00€
DEGETUL MARE ȘI CÂRLIGUL
PENTRU REF. 50840

50840	23,00	1	30
114,00€	Kg		

500Kg

1750mm



CE

SUPORT PENTRU MOTOR AUTO UNIVERSAL

52055	10,00	1	40
108,00€	Kg		

500Kg
980 x 270mm



Adaptabil la toate tipurile de autoturisme și autoutilitare.
Ideal pentru schimbarea curelei de distribuție sau curelelor auxiliare, înlocuirea sau schimbarea înclinării curelei din față.
Economisire, cu acest instrument se pot realiza acțiuni care se pot realiza doar cu instrumente specifice.
Manevrare ușoară.
Instalare rapidă doar cu ajutorul unui operator.
Instalare și acces prin partea inferioară.
Piesă perpendiculară cu unghi de rotație și reglabilă la orice înălțime a barei longitudinale.
Înălțimea cârligelor reglabilă, 360° rotația cârligelor.
Platina plastică de suport pentru a preveni desplasarea punctului de sprijin al barei.



CE

SUPORT PENTRU MOTOR

50836	17	1	30
98,00€	Kg		

340Kg

90 x 80 x 85cm



CE

50838	43,40	1	12
195,00€	Kg		

Dimensiuni pliabilitate: 100 x 50 x 44cm

500Kg

110 x 90 x 90cm



CE

SET DE 2 RAMPE CE RIDICĂ 1 TONĂ

52845	21	2	8
120,00€	Kg		

1T

Unealtă pentru prezentarea vehiculelor de expoziție, de asemenea și pentru a face lucrări în partea inferioară a vehiculului.

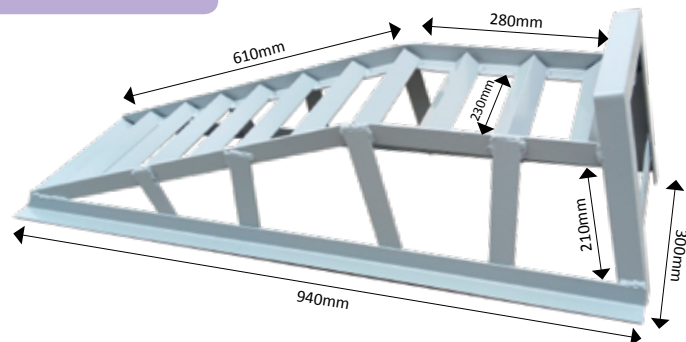

CE

SUPORT PT. ELEVATOR DE MOTOCICLETE

FAȚĂ

52514	4	1	28
64,00€	Kg	ff	ff

200Kg



SPATE

51751	5	4	12
59,00€	Kg	ff	ff

200Kg



FLAT

←255mm→

10671 15,20€



TUR

11892 9,90€



CRIC PENTRU MOTOCICLETE

52692	7,76	2	50
105,40€	Kg	ff	ff

450Kg

Min: 65mm
Max: 355mm

75 x 350mm



Cu tubulară de 21mm
Cu clichet de 3/8"

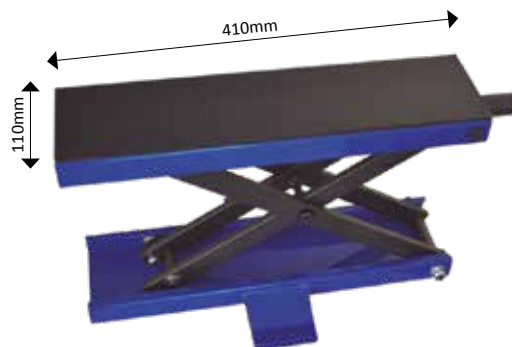

CE

ELEVATOR PENTRU MOTOCICLETE

51323	7,07	2	18
49,00€	Kg	ff	ff

140Kg

Min: 280mm
Max: 410mm

300 x 240mm



CE

ELEVATOR HIDRAULIC PENTRU MOTOCICLETE

51750	31	1	12
220,00€	Kg	ff	ff

135Kg

500 x 45mm

Min: 340mm
Max: 890mm



CE

ELEVATOR HIDRAULIC PENTRU MOTOCICLETE

50911	135	1	3
740,00€	Kg	ff	ff

365Kg

Min: 220mm
Max: 850mm

1.020 x 500mm

Fără platformă: 2.000mm



11087 16,00€
SUPOR DE AGĂȚARE
FIX

11088 28,90€
SUPOR DE AGĂȚARE
MOBIL

CE

MASĂ HIDRAULICĂ

50630	62	1	4
370,00€	Kg		

Min: 290mm
Max: 780mm



840 x 480mm



CE

10993 95,80€

PISTON DE SCHIMB
PENTRU REF. 50630

11950 18,00€

ARBORE DE SCHIMB
PENTRU REF. 50630

MASĂ HIDRAULICĂ

N

53246	104	1	4
884,40€	Kg		

Min: 360mm
Max: 1.290mm



CRIC HIDRAULIC 680Kg

50839	20,50	1	7
195,00€	Kg		

Deschidere totală: 254mm

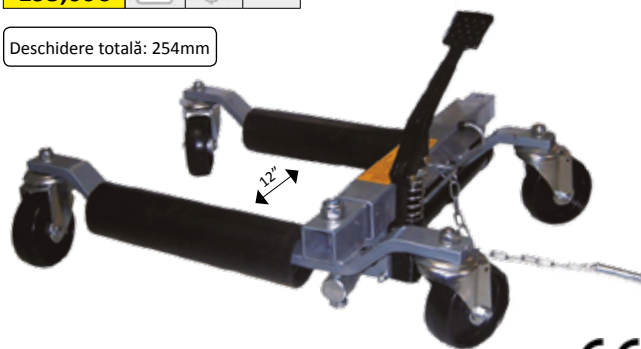

CE

CRIC ATV

N

53423	-	1	-
155,40€	Kg		

Min: 118mm
Max: 368mm



790 x 370 x 330mm

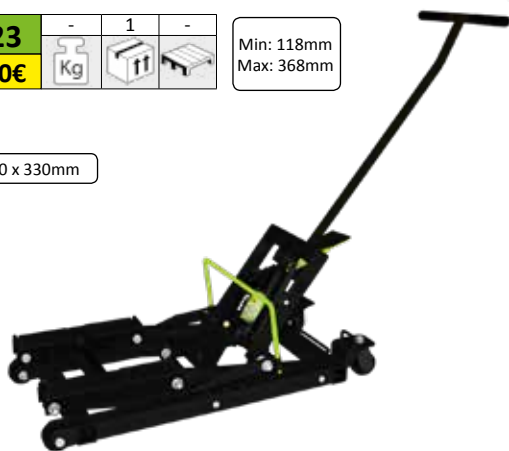

CĂRUȚOR PENTRU ROȚI CAROSERII

50923	32,90	1	15
184,00€	Kg		



48 x 80 x 130cm

Separare: de la 0 la 110cm

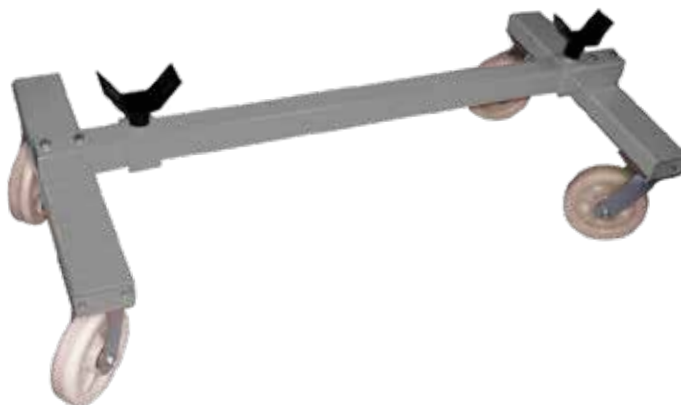

12022 33,70€

ROATĂ DE SCHIMB P/50923

CE

TRANSPALET MANUAL

N

53386	60,85	2	24
580,00€	Kg		



1150 x 525mm



fără TVA

JBM

WWW.JBMCAMP.COM

JBM
2018

201



12



SCULE ELECTRICE

CABLURI PENTRU REDRESOARE AUTO . . .	203
ÎNCĂRCĂTOARE DE BATERII	203
CIRCUIT DE TESTER AUTO.	205
PISTOL DE LIPIT	205
PISTOL DE LIPIT CU CĂLDURĂ	205
BORMAȘINĂ	206
ASPIRATOR INDUSTRIAL	206
MAȘINĂ DE SPĂLAT PIESE	207
POLIZOR ELECTRIC	208
STRUNG ELECTRIC.	208
COMPRESOR.	209

CABLURI PENTRU REDRESOARE AUTO

CLEME DIN ALAMĂ

REF.	Ø CABLU + CAPAC	LONG	Ah	SECȚIUNEA	Kg	ff	ff	€
51238	17mm	5m	700	70mm²	4,62	2	72	88,00€
51239	15mm	7m	700	70mm²	5,79	2	72	118,00€

REF.	Ø CABLU + CAPAC	LONG	Ah	SECȚIUNEA	Kg	ff	ff	€
52069	11mm	2,5m	250	25mm²	1,58	10	160	16,00€
52070	12mm	3m	350	35mm²	2,02	5	160	24,00€
52071	13mm	3m	500	50mm²	2,23	5	160	29,00€

CLEME DIN CUPRU CU PROTECȚIE DE SUPRASARCINĂ

REF.	Ø CABLU + CAPAC	LONG	Ah	SECȚIUNEA	Kg	ff	ff	€
51363	12mm	3m	350	35mm²	2,63	5	120	68,00€
51365	15mm	3m	500	50mm²	3,12	5	120	78,00€



CE

ÎNCĂRCĂTOR DE VEICUL FĂRĂ BATERIE

N

53387	-	10	-
215,15€	Kg	ff	ff



12V + ieșire USB

Echiptat cu condensatoare capabile să stocheze suficientă încărcătură electrică pentru a permite pornirea unui vehicul fără baterie.

Starterul poate fi încărcat de la o baterie epuizată.
Tensiune de ieșire: 12V / USB.



CURENT DE PORNIRE

450A CC12V



x5 CONDENSATOARE

2.7V 500F



TEMPERATURĂ DE LUCRU

-20°C a 60°C



TIMPUL DE REÎNCĂRCARE

70 segundos



ÎNCĂRCĂTOARE DE BATERII 12 - 24V

12V 50-140Ah

Intensitate de încărcare: 7A
Rang de aplicație: 12V / 50-140Ah

52290	1,14	10	320
72,00€	Kg	ff	ff

12V 134-400Ah

Intensitate de încărcare: 10A
Rang de aplicație: 12V / 134-400Ah

52291	1,36	10	320
134,00€	Kg	ff	ff

24V 70-200Ah

Intensitate de încărcare: 20A
Rang de aplicație: 24V / 70-200Ah

52292	1,36	10	320
150,80€	Kg	ff	ff

Încărcarea automată a bateriilor evită supraîncărcarea, cu funcție de auto-stop, termină ciclul de încărcare când bateria este pe deplin încărcată.

Valabil pentru baterii cu acid, GEL, AGM,...

Încărcarea bateriei se efectuează în 7 faze, evită păgubirea bateriei și permite o încărcare optimă.



CE

INVERTER 300W 12-220V

52954

55,70€

Kg 0,60

ff 6

ff 24

ff 240

300W

40A

DC 12V AC 220V



USB

UNIVERSAL

CE



TESTER DE BATERIE DIGITAL

51816	0,30	12	48	576	
49,00€	Kg	sub	ff	ff	

150Ah
Se aplică la baterii de 12 V.
Măsurare în SAE (CCA), EN, IEC, DIN, CA
Rang : 200~1 200 CAA (SAE)
Volt măsurat : 7 V~15 V
Ecran 4 + 3 Leduri (verde, roșu, galben)
Dimensiuni : 12x7x1,8 cm



CE

TESTER DE BATERIE

51235	1,35	10	150
42,00€	Kg	ff	ff

Pentru baterii de 6 V și 12 V
Încărcare de până la 100 Ah.
Test Starea Încărcării.
Test Consum de Încărcare.
Test de Tensiune Încărcare.
Test Condiții Baterie.



CE

TESTER DE BATERIE ȘI ALTERNATOARE CU IMPRIMANTĂ

52233	2,32	6	72
348,00€	Kg	ff	ff

Se aplică la baterii de 6v și 12v
Sisteme de încărcare și aprindere de 12v și 24v
Rang de operare: 40 - 2000 cca (sae)
Voltmetru: 1,5v - 30v
Joc de cabluri de 180cm

Include:
baterii 6x1.5aa
1 rolă de hârtie termică

51842 6,90€

HÂRTIE TERMICĂ
57mmx60m

0,10	6	24
Kg	sub	ff



CU
IMPRIMANTA

CE

TESTER ANTIGEL

N

53453	-	24	96	-
4,30€	Kg	sub	ff	ff



MEMORIE DEPOZIT PENTRU SCHIMBAREA BATERIEI

52884	0,25	20	1.500	
50,60€	Kg	ff	ff	

Util pentru a menține curent în sistemul electric al vehiculului în timpul.

Schimbului de baterie. Conexiune prin cablu OBDII sau brichetă.

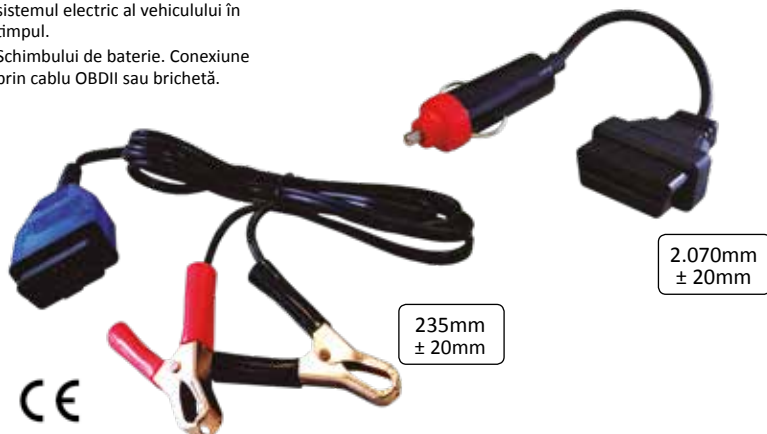

2.070mm
± 20mm

235mm
± 20mm

CE

HIDROMETRU PENTRU BATERII

N

53209	0,15	10	100
5,05€	Kg	sub	ff

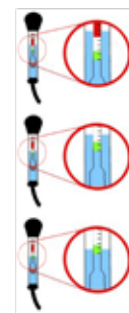

CIRCUIT DE TESTER AUTO

Potrivit pentru verificați polaritatea

53028	0,07	10	120	1.800
3,30€				

6 -12 -24V



1,8 x 190mm



53029	0,08	12	240	1.500
3,80€				

6 -12 -24V



2 x 115mm

53030	0,17	6	60	720
8,90€				

6 -12 -24V



3 x 142mm

PISTOL DE LIPIT DE 40W

52383	Tensiune 220-240V Temp. 420°C + / - 10% Lungime: 250mm Cablul: 1,5m
16,00€	
	0,22
	5
	100
	700



PISTOL DE LIPIT STANIU 100VW

53111	0,28	5	25
12,00€			
Tensiunea: 220-240 V Temp.: 420°C + / - 10% Lungime: 250 mm Cablul: 1,5 m			



PISTOL DE LIPIT CU ADEZIV CU ADEZIVE

51831	0,35	12	36	252
14,00€				
51859	3,80€		x11	
ADEZIV TERMOFUZIBIL				
	0,12	11	40	1.520



Ø 8mm
Lipește rapid toate tipurile de materiale flexibile.
Timp de uscare de 20"

Tensiune: 100~ 230 V
Temperatura: 190~230 °C
Consum: 60~150 W
Diam. conectorului: 2.0~2.3 mm
Rang: de 8 la 16g de produs/minut

PISTOL DE LIPIT CU CĂLDURĂ 1.600-2.000W

52465	
55,90€	
	1,01
	5
	10
	120



Potență: 1600-2000W
Flux de aer: 200-500l/min
Temperatură de ieșire: 50-550°C
Clasă de protecție: II

PISTOL DE LIPIT CU CĂLDURĂ 2000W

53145	
29,35€	
	1
	5
	165



220V-240V
50Hz-60Hz
2000W
Temperatura de ieșire: 50-600°C
Airflow: 220-480L / min
2 opțiuni de temperatură: 300 i 600

53162	
47,35€	
	0,90
	5
	165



220V-240V
50Hz-60Hz
2000W
Temperatura de ieșire: 100-600°C
Airflow: 280-480L / min

BORMAȘINĂ VERTICALĂ CU CUTIE DE VITEZE ȘI OPERARE CU PINIOANÉ

BORMAȘINĂ VERTICALĂ DE 8" - 220V

52192	15,50	1	21
158,00€			



BORMAȘINĂ VERTICALĂ DE 20" - 220V

52194	135	1	3
990,00€			



BORMAȘINĂ VERTICALĂ DE 10" - 220V

52193	28,25	1	12
310,00€			



	52192	52193	52194
Ø Columnei(mm)	48	59.5	92
Ferमार și pinion	✗	✓	✓
Dimensiunea bazei (mm)	280 x180	350 x 215	580 x 450
Dimensiune masă de lucru (mm)	165 x160	198 x196	475 x 425
Motor	300 W	400 W	1000 Br/ 1500 W
Înălțime (mm)	580	720	1710
Greutate	17/19	30/32	139/145
Dimensiune cutie (mm)	470x240x350	550x370x254	1450x653x333
Capacitate maximă de foraj (mm)	13	16	32
Capacitatea mandrinei	13	16	20
Capacitatea gâtului	40	55	75/85
Parcurs	8"	10"	20"
Cu AX	B16/JT33	MT2	MT3/MT4
Viteză în rpm (50Hz)	5 (500-2.500)	5/12	12 (120-3.480)
Viteză în rpm (60Hz)	5 (620-3.100)	5/12	12 (150-3.850)
Parcurs AX (mm)	50	60	120

CE

ASPIRATOR INDUSTRIAL

USCAȚI 30L

51837	8,25	1	9
175,10€			



INCLUDE



PIESE DE SCHIMB PENTRU REF. 51837

REF.	DESCRIERE	€
10720	Furtun din plastic 1,5m	14,80€
11095	Furtun din plastic 3m	19,10€
11097	Furtun din plastic 6m	33,40€
10721	Tub din metal extensibil	19,00€
10761	Filtru	16,00€

USCAȚI + HUMED 80L

51838	28	1	2
598,00€			



INCLUDE



PIESE DE SCHIMB PENTRU REF. 51838

REF.	DESCRIERE	€
10722	Furtun din plastic 1,5m	14,90€
11096	Furtun din plastic 3m	22,70€
11098	Furtun din plastic 6m	40,50€
10723	Cot superior	14,40€
10724	Cot inferior	14,40€
10762	Filtru	16,50€

	51837	51838
Capacitate (L)	30	80
Potenția	1 x 1.000W	3 x 1.000W
Tensiune	220V	220V
Frecvență	50Hz	50Hz
Evacuare	> 17Kpa	> 20Kpa
Ø Furtun	32mm	48mm
Lungime furtun	1,5m	1,5m
Lungime cablu	4,8m	4,8m
Etanșare	IPx4	IPx4

CE

MAȘINĂ DE SPĂLAT PIESE

50632	24,30	1	6
210,00€	Kg		

MĂSURILE INTERNE REZERVOR

260mm	725mm	490mm
-------	-------	-------

MĂSURILE TOTALĂ A UTILAJULUI

890mm	780mm	540mm
-------	-------	-------

Cap. rezervor : 100 l.

Debit: 25 l.

Dimensiuni: 780 x 540 x 875 mm



11100 16,00€

BIDINEA/
PENSULA DE
SCHIMB PENTRU
REF. 50632



11101 68,00€

POMPĂ PENTRU
MAȘINA DE SPĂLAT
PENTRU 50632



11102 6,60€

FILTRU PENTRU
MAȘINA DE SPĂLAT
PENTRU 50632



MAȘINĂ DE SPĂLAT PIESE 150L

52980	45,00	1	4
368,00€	Kg		

MĂSURILE INTERNE REZERVOR

490mm	1060mm	270mm
-------	--------	-------

MĂSURILE TOTALĂ A UTILAJULUI

890mm	1090mm	520mm
-------	--------	-------



MAȘINĂ DE SPĂLAT PIESE PORTABILĂ



53220	7,90	1	8
282,35€	Kg		

FORMAT PORTABIL. Permite închiderea etanșă la apă pentru a evita pierderile în timpul transportului.

Comutator de aprindere laterală

Filtru de curățare lichid inclus

Furtun și furtun de protecție incluse

Compartimentul de depozitare

Separarea zonelor de lucru, zona de curățare și zona de uscare permite lucrul cu mai multe bucăți odată.

Furtun lung de 1,10 m

Conectare la 220V

Capacitate de pompare: 1.000 L / h



APARAT PENTRU REGROVAT ANVELOPE PUTERE MAXIMA 350W

52643	7,96	1	48
490,00€	Kg		



	11974		11979
	11975		11980
	11976		11981
	11977		11982
	11978		11983

PIESE DE SCHIMB

1,20€/u.

REF.	11974	11975	11976	11977	11978
TIP DE LAMĂ	R1	R2	R3	R4	R5
LAMA ROTUND	mm	mm	mm	mm	mm
	A	3	5	6	8
	B	7	7	10	12
	C	5	8	15	16
	D	21	21	23	25

REF.	11979	11980	11981	11982	11983
TIP DE LAMĂ	W1	W2	W3	W4	W5
CUȚIT DE PĂTRAT	mm	mm	mm	mm	mm
	A	3	5	7	9
	B	7	7	10	12
	C	5	6	10	13
	D	21	21	22	24

POLIZOR ELECTRIC 150mm

52195	7,08	1	48
110,00€	Kg	ff	ff

Putere motor 250W
Tensiune alimentare 230V / 50Hz
Turație 2.950rpm
Diametru piatră 150 x 20 x 12.7mm
Greutate 8,5kg



POLIZOR ELECTRIC 150-200mm

52196	10,56	1	18
128,00€	Kg	ff	ff

Putere motor 250W
Tensiune de alimentare 230V / 50Hz
Turație 2.950rpm
Diametru piatră 150 X 20 X 12,7mm - 200 X 40 X 20mm
Greutate 9,5KG



STRUNG ELECTRIC

51118	45,00	1	4
2.980,00€	Kg	ff	ff



Înălțimea centrului	125mm
Diametru de oscilație max. peste batiu	250mm
Max. diametru piesă de șucru pentru suport	130mm
Max. piesă de lucru între axe (oc)	450mm
Lungime longitudinală maximă	420mm
Diametrul axului	27mm
Conul axului (con Morse)	CM4
Număr de trepte de turație a axului principal	6
Taxă de rotație ax (din față în spate)	115 - 1620 1/min
Numărul de rețele metrice normale	20n
Gamă de filet (filet metric normal)	0.2 - 3,5mm
Număr de rețele în țoli (Whitworth)	20n
Gamă de fire (fire în țoli)	8-56 t.p.i
Număr de rețele NU Standard	10
Gamă de fire (fire standard) / număr avansuri longitudinale și axiale	De 0.2 a 1,25
Gamă bare cărucior	0.05. 0.1 / 2mm
Distanța între axa știftului și suprafața inferioară a capului pătrat	15
Unghi max. rotativ al căruciorului prin față (backstage)	+ - 45°
Execuție fiecare parte a filetului din căruciorul transversal	0,04mm
Execuție fiecare parte al șurubului înainte	0,04mm
Lungime maximă voltaj. Transport în avans	70mm
Cruce max. călătorie a căruciorului transversal	115mm
Deplasarea găurii conice (păpuși mobile) con Morse	CM2
Carieră max. control deplasare (păpuși mobile)	70mm
Motor	0.37 kW, 220V, 50Hz
Dimensiuni(cm)	1.130 x 600 x 1.400

ECHIPAMENTELE INCLUSE



11077



11075



11076



11080



11078



11079



11085



11081



11084



13001

REF.	CARACTERISTICI	€
11075	Linetă de 2 puncte	58,00€
11076	Linetă de 3 puncte	92,60€
11077	Mandrină strung	78,00€
11078	Mandrină +manivelă strung	313,10€
13001	Joc de biți pentru strung	103,00€
11080	Set lame strung	98,00€
11082	Piesă de schimb vizor valvă	9,00€
11084	Piesă de schimb placă metalică	66,70€
11085	Adaptor flanșă de 3 bacuri pentru strung	198,00€
11079	Flanșă 5 găuri universală	22,00€
11081	Piesă de schimb roată manuală	19,10€
11083	Masă de lucru	390,00€
11086	Piesă de schimb protector din plastic	18,00€
11930	Piesă de schimb motor	292,00€

ADAPTOR ENGLEZESC PENTRU PRIZE



13816	0,50	-
0,60€	Kg	ff



COMPRESOR

51602	25L
220,00€	
Kg	23,90
ft	1
	4

51603	50L
280,00€	
Kg	28
ft	1
	4



	51602	51603
Capacitate (L)	25	50
Energie	1.5 kW/2HP	1.5 Kw/2,5HP
Voltaj	230 V	230 V
Frecvență	50 Hz	50 Hz
Motor	2P	2P
Viteză clasificată	1.500 r/min	2.950 r/min
Amperaj	7.5A	7.5A
Livrare	7.3 CFM	8.4 CFM
Presiune escărcare	115PSI/0.8Mpa	115PSI/0.8Mpa
Presiune reset	70PSI / 0.5Mpa	70PSI / 0.5Mpa
Ieșire de aer	1/4"	1/4"
Greutate	41Kg	45Kg
Debit aspirat L/MIN	234 l/min	240 l/min
Debit aspirat M3/H	14,08	14,30
Dimensiuni	760x270x580	810x370x670

COMPRESOR DE AER



53150	0,55	5	20	480
16,50€	Kg	ft	ft	

120mm	165mm	55mm
-------	-------	------

150 PSI 10 BAR	Ø30mm
-------------------	-------

DC 12V	100W 10A	16 L/min
--------	-------------	----------



ROLĂ / TAMBUR CABLU ELECTRIC

52429	5,10	1	2	64
138,40€	Kg	ft	ft	

Rolă de cablu electric
Lungime: 12 metri
Cablul: H07RN-F 3G1.5mm
Tensiune de funcționare:
230V - 50Hz
Putere maximă:
3.500W (cablu desfăcut)
1.000W (cablu strâns)
Index de etanșare: IP44



ROLĂ / TAMBUR CABLU ELECTRIC

51033	3,86	2	54
56,00€	Kg	ft	

Suport / tambur de
cablu electric
Lungime: 25 m
Cablul H05W-F 3X1.5 mm2
din PVC
IP20
Protecție de suprasarcină



VENTILATOR



PE PICIOR

53189	7,10	1	14
89,50€	Kg	ft	

132,5cm	48cm	Ø48cm
---------	------	-------

DE PODEA

53190	6,10	1	16
74,80€	Kg	ft	

57,5cm	23cm	Ø62cm
--------	------	-------



Voltaj (V): 230V
Frecvență (Hz): 50Hz
Putere (W): 120W
Setare viteze: 3
Viteză (rpm/min):
1050/1150/1300 rpm/min
Flux de aer (CFM):
2700/3000/3400 CFM

PRELUNGITOR



53166	0,45	30
8,55€	Kg	ft

3m

53167	0,65	20
10,50€	Kg	ft

5m

53168	1,20	10	300
16,25€	Kg	ft	

10m





13



ACCESORII

RULORI	211
ACCESORII DE ATELIER	211
ORGANIZATORI	216
SECURITATE	217
UNITĂȚI DE URGENȚĂ	221
SENZORI DE PARCARE	225
AUTO	227
ȘTERGĂTOARE DE PARBRIZE	228
CONTRAGREUTĂȚI	229
SUPAPE TPMS	231
PENTRU PNEURI	233

ROLĂ AUTOMATĂ CU FURTUN PENTRU APĂ DE 1/2"

50811	7,65	2	14
118,60€	Kg		

Suport/rolă pentru apă
Lungime: 15m + prelungitor 2m
Presiune 10 bar
Capăt de 1/2"



TAMBUR CU FURTUN RETRACTABIL

CONSULTĂRII PAG. 101



ROLĂ / TAMBUR CABLU ELECTRIC

CONSULTĂRII PAG. 209

ASPIRATOR GAZE DE EȘAPAMENT

52824	12,50	1	6
535,80€	Kg		

Extractor pneumatic de fum care, prin intermediul conexiunii la compresorul de aer, permite conexiunea sa directă la țeava de eșapament pentru a direcționa ieșirea fumului; util pentru a menține medii de muncă sănătoase sau în anumite cazuri în care vehiculul nu realizează o ardere corectă și generează un exces de fum.

Racord flexibil escamotabil permite înmagazinarea sa în corpul extractorului pentru a economisi spațiu de înmagazinare. Lungimea tubului escamotabil: 4 metri.

Capacitatea de aspirație: 185 L/min



REFRACTOMETRU UNIVERSAL

52963	
64,40€	

	0,28
	5
	20
	440

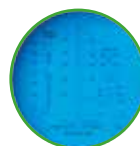

Etilen glicol: -50°C ~ -0°C
Propilen glicol: -50°C ~ -0°C
Lichid de curățare: -40°C ~ -0°C
Adblue: 30% ~ 35%
Lichid baterie: 1.100 - 1.400 sg/l

REFRACTOMETRU PENTRU ALCOOL

50731	0,56	5	500
98,00€	Kg		



ENDOSCOPII INDUSTRIALI CABLU 1m

52436	2,41	5	40
830,00€	Kg		

1m

ECRAN COLOR

Alimentare: DC5
Supraveghere 3,5TFT 320x240px
Interfață: MINI USB 1.1/AV
Baterie: Reîncărcabilă Li-Polimer 3.7V
Adaptor de curent: 100-240V
AC în ieșire 5VDC
Video în NTSC&PAL
Depozitare: CARD SD (până la 32Gb)
Comprimare: JPG
Înregistrare: MPEG4 (640x480)
Temperatură de lucru: -20°C - 60°C
Temperatură depozitare: 0°C - 40°C
Diam. cablu: 5 mm
Funcțiuni: ieșiri înregistrări, 6 limbi, auto-off, fotografii, înregistrări, dată/oră

11329	362,90€	11219	551,30€	11992	60,00€
CABLU 1m		CABLU 3m		PIESĂ DE SCHIMB PENTRU VÂRFUL ENDOSCOPIULUI	



MULTIMETRU DIGITAL

50942	0,33	10	60	480
24,00€	Kg			

Digiți: 3 1/2
Măsurare: 2 000
Date instant
Autoînchidere
Indicator de baterie

Baterii de 9 V
Sondă de temperatură
Temperatură de la -40 °C la 1 000 °C



CU PROTECȚIE LATERALĂ



TRUSĂ DE CABLURI ȘI ACC. PENTRU MULTIMETRU REF. 50942

52439	3,26	1	5	40
188,00€	Kg	sub	ff	

- 2 măsurători de rezistență variabile
- 2 lumini led de verificare
- 2 SRS substituție și a dispozitelor de probă
- 2 clești tip crocodil
- 2 prize cuplare rapidă
- 4 sonde
- 24 conectori formă rapidă
- 48 conectori formă lată



CE

SET DE ACCESORII PENTRU MULTIMETRU

52231	0,41	5	40	300
39,60€	Kg	sub	ff	

Kit potrivit pentru majoritatea multimetrelor

- Include:
- 2 sonde
- 2 cleme mici + 2 cleme lungi
- Cabluri prelungitoare



CE

CLEȘTE AMPERMETRIC

52382	0,23	5	50	1.600
24,00€	Kg	sub	ff	

FUNCȚII:

Live Test de sârmă

52952	0,26	50	1.500
64,80€	Kg	ff	

FUNCȚII:

- Live Test de sârmă
- Testul diodei
- Test de continuitate
- Funcție de ADP
- Funcția de detectare a fazei
- Comutator ZERO



	52382	52952
DCB	600V	20V, 600V
ACB	600V	600V
DCA		200A
ACA	20A, 200A, 600A	200A
OHM	2KΩ, 200KΩ, 2MΩ	2000Ω

CARACTERISTICI:

- Instrument ideal pentru electricieni.
- Se poate măsura: voltaj AC, voltaj DC, Curent AC, rezistență, diodă, frecvență.
- Mediu de operare: 0°C a 40°C, la <80%RH
- Mediu de depozitare: -10°C a 40°C, la <85%RH
- Alimentare: 2 baterii AAA
- Indicator de baterie descărcată
- Ecran de 3,5" cu 4 digiți
- Funție de curent continuu
- Măsurarea tensiunii AC/DC
- Dimensiuni: 167x55x22



52382



52952

TESTER RAPID CU CLEMĂ PENTRU MULTIMETRU

52438	0,17	100	800
42,80€	Kg	ff	



CE

TESTER PENTRU LICHID DE FRÂNE

51839	0,05	10	100	2.400
28,00€	Kg	sub	ff	

Funcționează cu baterii 1xAAA LR03
Cu 4 nivele de calitate măsurabile



TORȚĂ GAZ

51920	0,15	5	100	600
18,00€	Kg	sub	ff	

Gaz nu este inclus



SPRAY CU GAZ

51986	0,18	24	1.584
9,80€	Kg	ff	

200ml



TERMOMETRU DIGITAL CU LASER -50° A 330°C

52162
39,90€

Rang de măsurare:
de la -50° la 330 °C
(58 ° F la 626 °F)
Precizie: ± 2 ° C / ± 2%. Decimale 1:
a obiectului
Optiunea 1 retro iluminare
Măsurare în ° C / ° F
Emisivitate: 0.95
Timp de răspuns: 500ms
Indicator de baterie descărcată
Posibilitate de a bloca măsurarea



	0,17
	12
	72
	576

TERMOMETRU DIGITAL CU LASER -50° A 1.000°C

52450
125,60€

Termometru cu infraroșu
Lectură de:
-50°C ~1000°C / -58°F la 1.832°F
Toleranță +/-1,5°C



	0,72
	5
	20
	200

FUNCȚII:
Indicație laser pointer
Alarmă de temperatură maximă
sau minimă
Lectură în °C / °F
Funcție de rezultat de memorie
Indicator de baterie descărcată

SCARĂ DIN ALUMINIU

50517
68,00€

4	1	18

CU 4 TREPTE
Înălțime totală: 1,47m
Înălțime max. de lucru: 0,87m



50518
89,00€

4,70	3

CU 6 TREPTE
Înălțime totală: 1,91 m
Înălțime max. de lucru: 1,31m

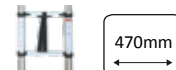
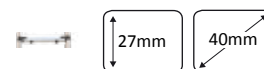

ÎNDEPLINEȘTE CU: EN 131

SCARĂ TELESCOPICĂ

51982
105,00€

5,51	1	30

Min: 730mm
Max: 2.000mm

6 TREPTE

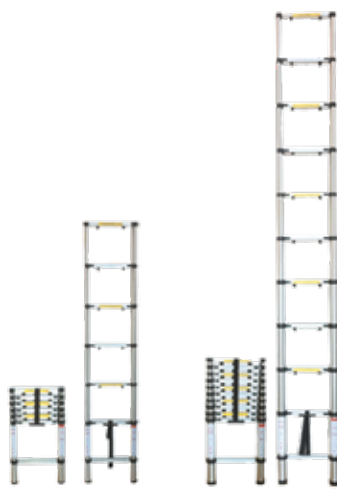

51982

51983
172,00€

9,41	1	15

Min: 930mm
Max: 3.200mm

9 TREPTE



51983

51984
210,00€

10,78	1	23

Min: 1.020mm
Max: 3.800mm

12 TREPTE



51984

SCARĂ TELESCOPICĂ ÎN "V" PLIANTĂ

52149
225,00€

4	3	18

Scară pliantă și ușoară.
Sistem de pieri prin blocare.
Fabricată din aluminiu și plastic.
Înălțime scară strânsă: 835mm
Înălțime scară deschisă: 3800mm

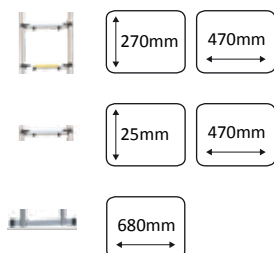

ÎNDEPLINEȘTE CU: EN 131

PLATFORMĂ DIN ALUMINIU TELESOPICĂ

52230	16,75	1	14
265,00€	Kg		

Lățimea platformei: 300mm
 Lungimea platformei strânsă: 1.090mm
 Lungimea platformei deschisă: 1.750mm
 Înălțimea reglabilă a platformei: 520-900mm
 Lățimea treptei: 40mm
 Distanța dintre trepte: 250mm
 Cap: 150kg

Poziții: 42 (14 orizontale x 3 verticale)
 Înălțime 1 : 520mm
 Înălțime 2 : 700mm
 Înălțime 3 : 900mm

ÎNDEPLINEȘTE CU: EN 131



10966 **9,80€**
 PICIOR DE SCHIMB
 PENTRU PLATFORMA
 CU REF. 52230

10965 **5,00€**
 TAMPON TREAPTĂ
 PENTRU PLATFORMĂ
 CU REF. 52230

10964 **5,30€**
 PROTECTOR COLȚ
 PENTRU PLATFORMA CU
 REF. 52230

PLATFORMĂ MARE DIN ALUMINIU

50913	6,50	1	18
96,00€	Kg		

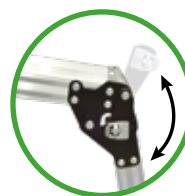
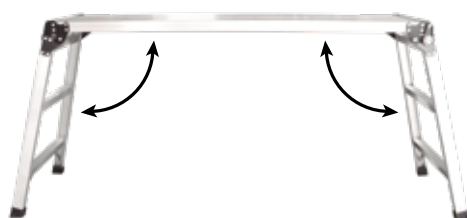
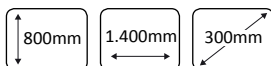

ÎNDEPLINEȘTE CU: EN 131

SET DE 2 PLATFORME DIN ALUMINIU

50656	10,45	1	8
198,00€	Kg		

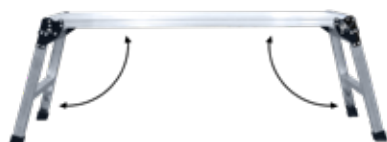
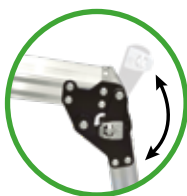
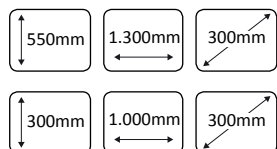

ÎNDEPLINEȘTE CU: EN 131

CĂRUCIOR MARFĂ DIN ALUMINIU PLIABIL ȘI EXTENSIBIL

52201	6,18	1	30
54,00€	Kg		



DESCHIS



STRĂNS

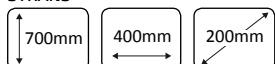

CĂRUCIOR MARFĂ DIN OȚEL BAZIC

52202	9,35	1	10
60,00€	Kg		



12055 13,00€

ROATĂ DIN PLASTIC
3.00-4 (260x85) PT.
REF. 52202



13803 7,05€

CAPAC PENTRU AXUL
CĂRUȚULUI REF. 52202



CĂRUCIOR PENTRU PLATFORME

52200	8,82	1	28
64,00€	Kg		

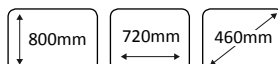

CUTIE DIN PLASTIC PENTRU SCULE CU COMPARTIMENTE

50958	2,00	6	24	
29,90€	Kg			



ORGANIZATOR CU 5 COMPARTIMENTE

51051	1,61	12	48	
26,00€	Kg			

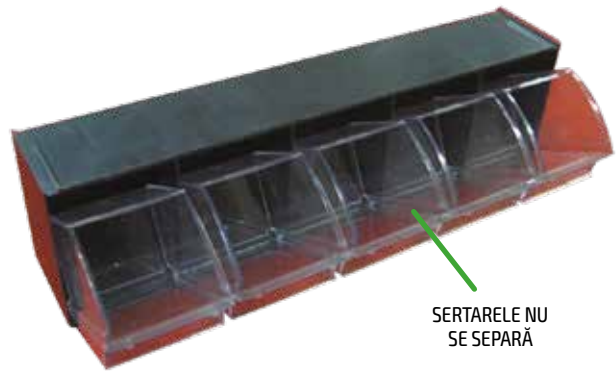

SERTARELE NU SE SEPARĂ

CUTIE DIN PLASTIC PENTRU SCULE

50957	1,13	12	48	
17,50€	Kg			

24 compartimente de 8x5,5 cm
2 compartimente de 15x7,5 cm
Variabile de la 26 la 5 separații

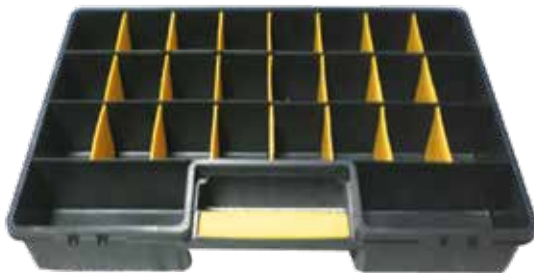

CUTIE DIN PLASTIC PENTRU SCULE

50959	0,70	16	128	
12,40€	Kg			

18 compartimente de 6x7 cm
1 compartiment de 35x7 cm
Variabile până la 4 separații



ORGANIZATORII

SET DE 8 SERTARE ETAJABILE CU BARĂ

50960	0,71	10	120
15,30€	Kg		

	SERTARE
	GHIDUL



SET DE 4 CUTII PENTRU SCULE

50961	7,75	4	16
81,90€	Kg		

Dimensiuni:
15x40x15 cm
15 compartimente
Compartimente exterioare mobile
18x45x19 cm
15 compartimente
Compartimente exterioare mobile
23x50x24 cm
17 compartimente
Compartimente exterioare mobile
28x60x30 cm
18 compartimente
Compartimente exterioare mobile



ORGANIZATOR CU PICIOR 47 COMPARTIMENTE



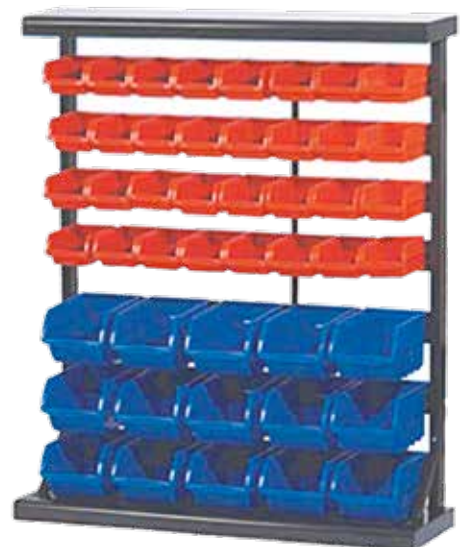

51050	22,50	1	8	
216,50€	Kg			

COMPARTIMENTE MARI
Total: 15
Dimensiuni:
24x14.5x13 cm
Dimensiunea raftului:
84x14x24 cm
Total rafturi: 3

COMPARTIMENTE MICI
Total: 32
Dimensiuni:
16x10x7.5 cm
Dimensiunea raftului:
84x16x8 cm
Total rafturi: 4







CĂȘTI PENTRU PROTECȚIE AUDITIVĂ

52430	
7,90€	
 0,34	
 6	
 24	
 240	



ÎNDEPLINEȘTE CU: EN352 - 1:2003

SET 3 MĂȘTI PENTRU PROTECȚIA CĂILOR RESPIRĂTORII, DE UNICĂ FOLOSINȚĂ





52431	0,05	25	100	800
3,40€				

Îndeplinește cu FFP1
Substanțe lichide și solide nu toxice în concentrație până la:
4.5 x concentrație maximă admisibilă
4.5 x limită de expunere ocupațională
4.5 x valoare limită de prag
20 x valoare de protecție alocată



ÎNDEPLINEȘTE CU: FFP1

OCHELARI DE PROTECȚIE

52442	0,06	12	300	1.800
3,70€				

CE

52442







CE

SOARE

52445

ÎNDEPLINEȘTE CU: EN166:2001

OCHELARI DE PROTECȚIE SPORT

52440	0,04	12	300	1.800
3,90€				

CE

52440



CE



SOARE

52441



ÎNDEPLINEȘTE CU: EN166:2001

OCHELARI DE PROTECȚIE CU LANTERNĂ LED

52701	0,24	12	40	160
30,90€				



2 LEDS



CE

ÎNDEPLINEȘTE CU: EN166:2001

MĂNUȘI DE LUCRU PENTRU ECRANE TACTILE

REF.	0,24	12	144	3.456
1,99€	Kg	56	11	

52570	T.8
52571	T.9
52572	T.10
52573	T.11



MĂNUȘI DE UNICĂ FOLOSINȚĂ, DE NITRIL 4,5MIL

52447	0,55	10	340	M
7,50€	Kg	11	11	
52448	0,57	10	340	L
7,85€	Kg	11	11	
52449	0,64	10	340	XL
7,95€	Kg	11	11	
52681	0,62	10	340	M
7,85€	Kg	11	11	
52682	0,62	10	340	L
8,15€	Kg	11	11	
52683	0,67	10	340	XL
8,25€	Kg	11	11	



100 unități în cutie
Mănuși de mare calitate
Ambidextru
Fără praf. Nu sunt sterile
Grosime: 4,5MIL



MĂNUȘI DE LUCRU CU PALMA ÎNTĂRITĂ DE NITRIL

51633	T.8
51634	T.9
51632N	T.10
51398N	T.11



REF.	0,04	12	144	3.456
0,99€	Kg	UDS PACK	11	



MĂNUȘI DE LUCRU CU PALMA ÎNTĂRITĂ DE POLIURETAN

51640N	T.8	51636N	T.10
51642N	T.9	51638N	T.11



REF.	0,03	12	144	3.888
1,18€	Kg	UDS PACK	11	



MĂNUȘI DE LUCRU DIN FIR DE BUMBAC

51745	0,05	12	144	3.744
0,48€	Kg	UDS PACK	11	



MĂNUȘI DE LUCRU DIN FIR DE BUMBAC, CU PALMA ÎNTĂRITĂ CU PUNCTE

51785	0,04	12	300	4.800
0,52€	Kg	UDS PACK	11	



CU PALMA ÎNTĂRITĂ

MĂNUȘI DE LUCRU DIN PIELE ȘI PÂNZA

52310	0,19	12	100	1.200
2,90€	Kg	UDS PACK		



CE

MĂNUȘI DE PIELE

N

T.9				
52738	0,10	144	2.880	
4,65€	Kg			



52738

T.10				
52739	0,10	144	2.880	
4,65€	Kg			



52739

EN388: 16
CE 2121X

LACĂT

53403	0,10	8	96		38mm
5,10€	Kg				

53405	0,01	8	95		32mm
4,00€	Kg				

53406	0,30	8	48		50mm
6,80€	Kg				

53407	0,50	10	48		63mm
10,00€	Kg				

53408	0,80	3	24	840		75mm
15,25€	Kg					



LUNG

53404	0,20	8	96		38mm
5,30€	Kg				

53409	0,30	8	48		50mm
7,60€	Kg				



LACĂT REZISTENT LA APĂ

53399	0,90	8	48		30mm
2,80€	Kg				

53400	0,20	8	48		40mm
3,60€	Kg				

53401	0,35	8	48		50mm
4,15€	Kg				

53402	0,60	10	40		65mm
7,60€	Kg				



CU CAPAC DE
PROTECȚIE



PUNGĂ MINI KIT DE URGENȚĂ 610x150mm

N

REF.	0,08	100	2.800
1,50€	Kg		

53242		53244	
53243		53245	



VELCRO

PUNGĂ CU TIVURI PENTRU KIT DE URGENȚĂ 550 x 90 x 130mm

REF.	0,21	100	1.100	51692		51694	
2,00€	Kg			51693		51696	



VELCRO

PUNGĂ NEAGRĂ PENTRU KIT DE URGENȚĂ DIN PVC 570 x 110 x 65mm

51691	0,18	100	1.200
2,40€	Kg		



VELCRO

PUNGĂ MARE 460 x 135 x 165mm

REF.	0,14	100	1.200	51682		51695	
1,90€	Kg						



VELCRO

PUNGĂ MINI 550 x 80 x 70mm

REF.	0,14	100	1.200	51684	
1,90€	Kg			51685	

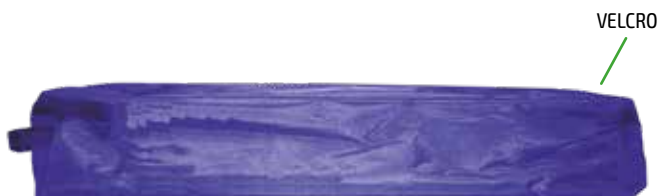

VELCRO

PUNGĂ NYLON VERDE SPECIALE 470 x 65 x 140mm

10945	0,12	100
2,30€	Kg	



VELCRO

PUNGĂ CU 6 COMPARTIMENTE PENTRU KIT DE URGENȚĂ 570 x 100 x 130mm

51680	0,18	100	800
2,40€	Kg		

Pungă cu 6 compartimente și divizare din pânză albastră și cu închidere velcro
Divizare centrală cu 3 compartimente



KIT DE SECURITATE ȘI DE URGENȚĂ



CONSULTAȚI VALORILE DE PRET
SERIGRAFIE ȘI PHOTOLITHOGRAPH NU ESTE INCLUS



KIT DE URGENȚĂ PUNGĂ MINI



x1

53169	11,00€	
53170	11,00€	
53171	11,00€	
53172	11,00€	



x2

53173	15,00€	
53174	15,00€	
53175	15,00€	
53176	15,00€	



KIT DE URGENȚĂ

KIT DE URGENȚĂ PUNGĂ CU RIVET



x1

53177	11,50€	
53178	11,50€	
53179	11,50€	
53180	11,50€	



x2

53181	16,00€	
53182	16,00€	
53183	16,00€	
53184	16,00€	

KIT DE URGENȚĂ PUNGĂ PVC



x1

53185	13,00€	
-------	--------	--



x2

53186	17,00€	
-------	--------	--

KIT DE URGENȚĂ PUNGĂ

N

MK H1

52768 18,50€

52772 18,50€

52776 18,50€

52780 18,50€

MK H4

52769 18,50€

52773 18,50€

52777 18,50€

52781 18,50€

MK H7

52770 18,50€

52774 18,50€

52778 18,50€

52782 18,50€

MK H7+H1

52771 18,50€

52775 18,50€

52779 18,50€

52783 18,50€

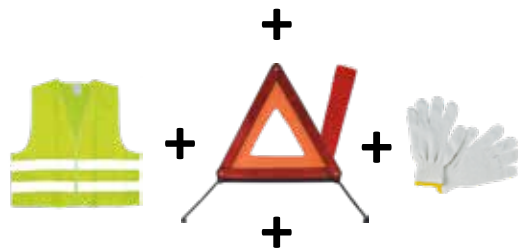

H1 (12V)



H4 (12V)



H7 (12V)



KIT DE URGENȚĂ PUNGĂ CU RIVET

N

53087 11,50€

53088 11,50€

53089 11,50€

53090 11,50€

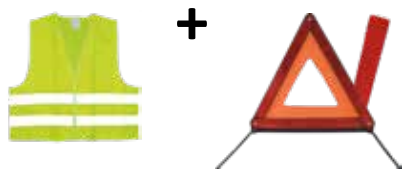

KIT DE URGENȚĂ PUNGĂ MINI

N

53091 10,70€

53092 10,70€

53093 10,70€

53094 10,70€

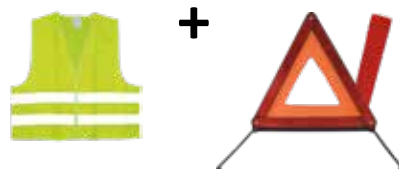

TRIUNGHI DE SEMNALIZARE OMOLOGAT

x1

52795	0,59	20	980
4,90€	Kg	11	11

x2

52808	0,56	40	800
7,60€	Kg	11	11



VESTĂ CU BANDĂ REFLECTORIZANTĂ MARCATĂ OMOLOGATĂ

51817	0,13	100	2.600
3,72€	Kg	11	11

50654	0,13	100	2.600
3,45€	Kg	11	11

BANDA DE MARCARE

50966	0,13	100	2.600
3,10€	Kg	11	11



ÎNDEPLINEȘTE CU: EN ISO20471:2013

KIT DE URGENȚĂ

CENTURĂ DE SIGURANȚĂ PENTRU AUTOCAR

CENTURĂ DE 2 PUNCTE

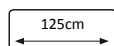

ÎNDEPLINEȘTE CU: E4-16R-0436213

50644	0,40	40	1.600
11,60€	Kg	ff	ff

CENTURĂ DE 2 PUNCTE
CARE SE STRÂNGE

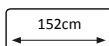

ÎNDEPLINEȘTE CU: E4-16R-0436232

50717	0,75	20	500
21,00€	Kg	ff	ff

CENTURĂ CARE SE STRÂNGE
DE 3 PUNCTE



ÎNDEPLINEȘTE CU: E4-16R-0436232

51266	1,13	20	320
27,60€	Kg	ff	ff

TRUSĂ DE PRIM AJUTOR

51246	0,20	50	1.000
6,40€	Kg	ff	ff

Conține:
1 manual de prim ajutor
1 foarfece
1 pereche de mănuși de latex
1 șervețel cu săpun
2 șervețele cu alcool
2 plasturi adezive
25gr. din bumbac

1 Plic cu 5 comprese
20x20cm
1 Fașă
1 Rolă leucoplast
Dimensiuni pungă:
80x130x55mm



DISTINCTIV PENTRU VEHICULE DE TRANSPORTAT MARFĂ

51935	0,12	50
142,00€	Kg	ff

51936	0,13	50
142,00€	Kg	ff

51937	0,12	50
142,00€	Kg	ff

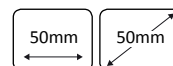

Se aplică începând de la 10 iulie 2011 ca urmare a modificării Regulamentului General de Vehicule aprobat prin Real Decretul 2822/1998, din 23 dec. 2010
Bobine indivisibile de 50 m

Aprobare: Regulamentul CEPE/ONU 104R

SET ORGANIZATOR DE PORTBAGAJ MULTIFUNCȚIONAL

52618	0,55	40	800
48,00€	Kg	ff	ff

Set compus din 4 piese:

Cutie din plastic flexibilă 37 litri cu capac (300mm x 490mm)

Bidon circular cu capac de 180mm de diam. (230mm înălțime)

Agățător poartă pentru obiecte fără capac (90mm înalt x 260mm lat)

Tavă rigidă (175mm înaltă x 300mm lată)

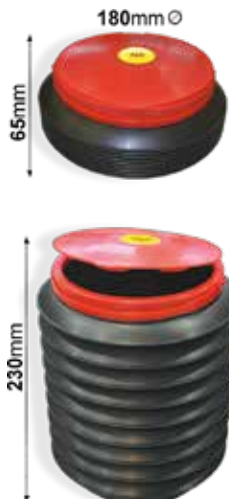

RACLETĂ, CURĂȚĂTOR GHEAȚĂ GEAM

51697	0,03	300	6.000
0,38€	Kg		



PISTOL DIN PLASTIC PENTRU SPRAY

52493	0,06	12	100
3,50€	Kg		

Accesoriu util, se poate utiliza cu majoritatea spray-urilor de pe piață



SPRAY REPARĂ ÎNȚEPĂTURI ROȚI

51814	0,30	12	996
7,99€	Kg		

300 ml



Pentru a repara înțepături în mai puțin de un minut fără a fi necesară schimbarea roții sau demontarea acesteia.

PELERINĂ IMPERMEABILĂ

50525	0,03	250	6.250
0,88€	Kg		



UMBRELĂ PLIANTĂ

50526	0,20	100	2.000
3,60€	Kg		



FOARFECĂ MINI DE 9 cm

51925	0,01	200	1.000	40.000
0,98€	Kg			



CIOCAN SPART GEAMURI AUTO, CU SUPTOR SCURT-CUREA

52259	0,16	50	100	2.000
3,00€	Kg			

135mm

75mm

20mm

∅ 160mm



SUPTOR TELEFON PENTRU AUTO

N

53443	0,05	100
6,15€	Kg	

mín: 55mm
máx: 83mm



ADAPTOR USB PENTRU BRICHETĂ

N

13855	0,06	10	100
6,20€	Kg		

Intrare: 12V
Leșire: 5V



COARDĂ MULTIUZ 30M

N

53233	1	6	24	96	Ø 1/2"
16,05€	Kg				

53234	0,40	6	24	288	Ø 1/4"
6,90€	Kg				



SET LAVETE DIN MICROFIBRĂ

N

53221	0,03	50	800	3
3,20€	Kg			PCS



LOPATĂ PLIANTĂ

51858	0,96	20	320
9,90€	Kg		

Fabricată din metal rezistent
Strânsă: 240mm
Deschisă: 600mm



LOPATĂ EXTENSIBILĂ DIN ALUMINIU

53033	0,63	5	65
10,50€	Kg		



SENZOR DE PARCARE CU ALARMĂ 4 PINI - 8 PINI

x8

52742	0,91	5	20	120
62,00€	Kg			

x4

52743	0,55	20	240
35,00€	Kg		

Senzor de parcare cu alarmă, cu 8 pini
Față + spate
Alarmă audio disponibilă
4 senzori spate + 4 față pentru 52742
Rezistență la ploii și timpuri urât
Piese de schimb disponibile
Pini se pot revopsi



KIT DE URGENȚĂ

SENZOR DE PARCARE CU ALARMĂ LED 4 PINI

52744	0,55	5	20	240
38,00€	Kg	3.6	11	

LED x4

Led digital de 3 culori cu sireună incorporată
 Intrerupător de control de volum
 Senzor demontabil
 Indicator de direcție, dreapta și stânga
 Alarmă voce
 4 senzori spate
 Rezistenți la ploii și timp urât

Distanță reglabilă de la roata de rezervă
 Piese de schimb disponibile
 Pini se pot revopsi



SENZOR DE PARCARE CU DETECTOR VIZUAL ȘI ACUSTIC

51863	0,63	20	200
53,00€	Kg	11	

Parametri tehnici:
 Tensiune nominală: dc 12 v
 Putere: 3,6 w
 Temperatură de lucru: -20° à 70°
 4 senzori de apropiere
 Distanță de detecție: 0,3-2,0 m
 Unghi de detecție: h>60°, v>60°
 Radio frecvență: 315 mhz / 433 mhz
 Include un indicator cu 2 culori care avizează apropierea de obstacole.
 Senzori de culoare neagră. nu se pot vopsi.



SENZOR DE PARCARE CU DETECTOR ACUSTIC

51973	0,54	20	240
42,00€	Kg	11	

Parametri tehnici :
 Tensiune nominală : dc 12 v
 Putere : 3,6 w
 Temperatură de lucru : -20° à 70°
 4 senzori de apropiere
 Distanță de detecție: 0,3-2,0 m
 Unghi de detecție : h>60°, v>60°
 Radio frecvență : 315 mhz / 433 mhz
 Fără indicator vizual
 Include sonerie de 4cm. diametru
 Senzori de culoare neagră. nu se pot vopsi.



SUPORT NUMĂR ÎNMATRICULARE

51412	0,09	100	3.000
1,50€	Kg	11	

Dimensiuni: 53,20 cm x 13,70 cm
 Domeniul de marcare : 52 cm x 1,60 cm
FOTOLITO ȘI SERIGRAFIA NU SUNT INCLUSE



COVORAȘ AUTO DIN CAUCIUC UNIVERSAL

N

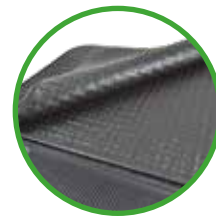

53241

5,95€

Kg	1,65
ft	12
	288

4 PCS



Cauciuc de calitate superioară
Foarte rezistent
Adaptabil la majoritatea vehiculelor



COVORAȘ AUTO DIN CAUCIUC UNIVERSAL

50585

9,80€

2,86	8	208
Kg	ft	

Cauciuc de calitate superioară
Foarte rezistent
Adaptabil la majoritatea vehiculelor



EXPOZITOR
DISPONIBIL



JOC COVORAȘE AUTO DIN MOCHETĂ

52530

10,80€

2	8	144
Kg	ft	



Conține:
2 covorașe față (390mm)
2 covorașe spate (365x480mm)

Ușoare, confortabile, cu bordură
din plastic revers cu tampoane din cauciuc
antialunecare



ÎNĂPOI



METEXP 34,90€

EXPOZITOR PENTRU
COVORAȘE AUTO



JOC COVORAȘE AUTO DIN MOCHETĂ

ALUMINIU

52534

12,00€

1,55	8	160
Kg	ft	



PODEA

52535

9,40€

1,55	8	160
Kg	ft	



Conține:
2 covorașe față (425x660mm)
2 covorașe spate (295x425mm)

Ușoare, confortabile, cu bordură din
plastic revers cu tampoane din cauciuc
antialunecare

ÎNĂPOI



EXPOZANT
DISPONIBIL



52534



52535



ȘTERGĂTOR AUTO EXPOZITOR DISPONIBIL

REF.	DESCRIERE	Kg	Box	Tray	Unit	€
JBMWB18S	18" 450mm	0,17	15	60	600	6,55€
JBMWB19S	19" 480mm	0,19	15	60	600	7,05€
JBMWB20S	20" 500mm	0,19	15	60	600	7,20€
JBMWB21S	21" 530mm	0,20	15	60	600	7,70€
JBMWB22S	22" 550mm	0,22	15	60	600	7,85€
JBMWB24S	24" 600mm	0,22	15	60	600	8,50€
JBMWB26S	26" 650mm	0,28	15	60	600	10,30€
JBMWB28S	28" 700mm	0,30	15	60	600	11,40€

x1



JOC DE ȘTERGĂTOARE AUTO EXPOZITOR DISPONIBIL

REF.	DESCRIERE	Kg	Box	Tray	Unit	€
JBMWB13	13" 330mm	0,20	15	60	720	8,05€
JBMWB14	14" 350mm	0,21	15	60	600	8,30€
JBMWB15	15" 380mm	0,23	15	60	600	8,90€
JBMWB16	16" 410mm	0,25	15	60	600	9,35€
JBMWB17	17" 430mm	0,28	15	60	600	10,55€
JBMWB18	18" 450mm	0,30	15	60	600	10,70€
JBMWB19	19" 480mm	0,32	15	60	600	11,25€
JBMWB20	20" 510mm	0,32	15	60	600	11,45€
JBMWB21	21" 530mm	0,35	15	60	600	12,50€
JBMWB22	22" 550mm	0,37	15	60	600	12,70€
JBMWB24	24" 600mm	0,40	15	60	600	13,45€

x2



BRAȚ PENTRU ȘTERGĂTOR DE PARBRIZE 10 PINI



JBMWBEXP	1,07	10
15,00€	Kg	Tray

EXPOZITOR



x1

REF.	DESCRIERE	Kg	Box	Tray	Unit	€
52394	11" 275mm	0,15	10	50	850	8,15€
52395	12" 300mm	0,15	10	50	850	8,15€
52396	13" 325mm	0,16	10	50	850	8,25€
52397	14" 350mm	0,16	10	50	800	8,50€
52398	15" 375mm	0,18	10	50	800	8,60€
52399	16" 400mm	0,18	10	50	800	8,45€
52400	17" 425mm	0,19	10	50	800	8,90€
52401	18" 450mm	0,20	10	50	800	9,35€
52402	19" 475mm	0,20	10	50	800	9,45€
52403	20" 500mm	0,22	10	50	800	9,65€
52404	21" 525mm	0,22	10	50	700	9,90€
52405	22" 550mm	0,23	10	50	700	9,95€
52406	24" 600mm	0,25	10	50	600	10,70€
52407	26" 650mm	0,25	10	50	600	10,85€
52408	28" 700mm	0,26	10	50	600	11,35€
52409	30" 750mm	0,29	10	50	500	13,40€

CONTRAGREUTATE DIN ZINC AUTOADEZIVĂ ÎN PASTILE DE 45g. (BENZI DE ZINC 5g - 10g - 5g - 10g - 5g - 10g)

50600	0,05	100	400	16.000
0,66€	Kg			

50601	0,05	100	400	38.400
0,20€	Kg			



ZINC
50600



DIN FIER
50601

CLEȘTE PENTRU VULCANIZARE

51355	0,45	10	50	500
14,90€	Kg			

Extrage ușor și înlocuiește greutatea.
Taie și îndoaie cu ușurință.
Din oțel, rezistent la căldură.
Include mâner ergonomic.
Include arc de deschidere pentru a ușura utilizarea acestuia.



CONTRAGREUTATE AUTOADEZIVĂ DIN FIER 60g.

52665	52666
0,26€	0,26€
Kg	Kg
0,06	0,06
100	100
400	400
33.200	30.000

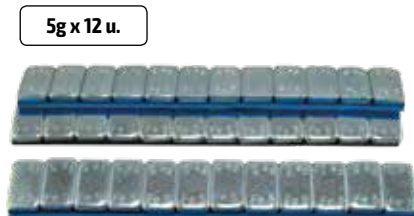

Adeziv de mare prindere și lungă durată.

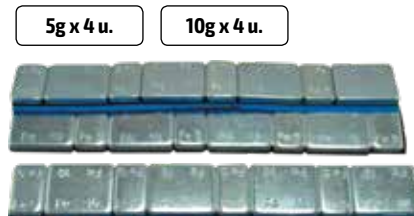

Adeziv de mare prindere și lungă durată.



CONTRAGREUTATE CU CAPSĂ DIN ZINC JANTA UNIV.

REF.	g.	Kg				€
50760	5g	0,01	100	1.600	20.000	0,09€
50761	10g	0,01	100	1.600	29.600	0,12€
50762	15g	0,02	100	800	29.200	0,20€
50763	20g	0,02	100	800	30.000	0,25€
50764	25g	0,03	100	800	20.000	0,31€
50765	30g	0,03	100	400	20.000	0,36€
50766	35g	0,04	100	400	10.000	0,43€
50767	40g	0,04	50	400	12.400	0,51€
50768	45g	0,05	50	400	2.250	0,54€
51055	50g	0,05	50	400	2.000	0,64€



CONTRAGREUTATE CU CAPSĂ DIN ZINC JANTA FR.

REF.	g.	Kg				€
50769	5g	0,01	100	1.600	20.000	0,09€
50770	10g	0,01	100	1.600	10.000	0,13€
50771	15g	0,03	100	800	6.600	0,19€
50772	20g	0,02	100	800	5.000	0,25€
50773	25g	0,03	100	800	4.000	0,30€
50774	30g	0,03	100	800	3.300	0,39€
50775	35g	0,04	50	400	2.850	0,44€
50776	40g	0,04	100	400	2.500	0,46€
50777	45g	0,05	50	400	2.250	0,53€
51056	50g	0,05	50	400	2.000	0,64€



CONTRAGREUTATE CU CAPSĂ DIN ZINC JANTA ALIAJ

REF.	g.	Kg				€
50778	5g	0,01	100	1.600	20.000	0,09€
50779	10g	0,01	100	800	10.000	0,12€
50780	15g	0,02	100	800	6.600	0,19€
50781	20g	0,02	100	800	5.000	0,25€
50782	25g	0,03	100	800	4.000	0,30€
50783	30g	0,03	100	400	3.300	0,36€
50784	35g	0,04	50	400	2.850	0,44€
50785	40g	0,04	50	400	2.500	0,51€
50786	45g	0,05	50	400	2.250	0,59€
51604	50g	0,05	50	400	2.000	0,64€



CONTRAGREUTATE UNIVERSALĂ PT. CAMION

SEGMENTARE DE 50g

52667	0,05	50	400	25.600
0,64€	Kg	sub	ff	

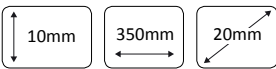

SEGMENTARE DE 200g

52670	0,20	10	80	5.120
2,50€	Kg	sub	ff	

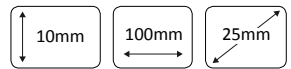

SEGMENTARE DE 100g

52668	0,10	25	200	12.800
1,21€	Kg	sub	ff	

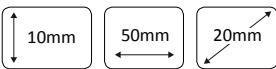

SEGMENTARE DE 250g

52671	0,25	10	80	5.120
2,97€	Kg	sub	ff	

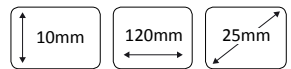

SEGMENTARE DE 150g

52669	0,15	20	160	10.240
1,80€	Kg	sub	ff	



SEGMENTARE DE 300g

52672	0,30	10	80	5.120
3,55€	Kg	sub	ff	

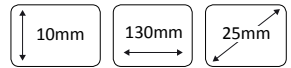

52667



52668



52669



52670



52671



52672

TRUSĂ DE CONTRAGREUTĂȚI ASORTATE

50938
144,00€

Kg	13,63
ff	1
sub	52



CONTRAGREUTATE EXTRALATĂ DIN FIER
AUTOADEZIVĂ 45gr. 100 u.



CONTRAGREUTATE DIN ZINC CU CAPSĂ:

	SERIE A	SERIE B	SERIE C
SPECIAL JANTA UNIVERSAL	5g: 20 uds	5g: 20 uds	5g: 20 uds
	10g: 20 uds	10g: 20 uds	10g: 20 uds
	15g: 20 uds	15g: 20 uds	15g: 20 uds
	20g: 20 uds	zz20g: 20 uds	20g: 20 uds
	25g: 20 uds	25g: 20 uds	25g: 20 uds
	30g: 10 uds	30g: 10 uds	30g: 10 uds
	35g: 10 uds	35g: 10 uds	35g: 10 uds
	40g: 10 uds	40g: 10 uds	40g: 10 uds
SPECIAL JANTA FRANCEZĂ	5g: 20 uds	5g: 20 uds	5g: 20 uds
	10g: 20 uds	10g: 20 uds	10g: 20 uds
	15g: 20 uds	15g: 20 uds	15g: 20 uds
	20g: 20 uds	20g: 20 uds	20g: 20 uds
	25g: 20 uds	25g: 20 uds	25g: 20 uds
	30g: 10 uds	30g: 10 uds	30g: 10 uds
	35g: 10 uds	35g: 10 uds	35g: 10 uds
	40g: 10 uds	40g: 10 uds	40g: 10 uds
SPECIAL JANTA DIN ALIAJ	5g: 20 uds	5g: 20 uds	5g: 20 uds
	10g: 20 uds	10g: 20 uds	10g: 20 uds
	15g: 20 uds	15g: 20 uds	15g: 20 uds
	20g: 20 uds	20g: 20 uds	20g: 20 uds
	25g: 20 uds	25g: 20 uds	25g: 20 uds
	30g: 10 uds	30g: 10 uds	30g: 10 uds
	35g: 10 uds	35g: 10 uds	35g: 10 uds
	40g: 10 uds	40g: 10 uds	40g: 10 uds



SUPORT DE CONTRAGREUTĂȚI AUTO-ADEZIVĂ - PASTILE DIN FIE DE 5g.

51908	5,82	4	200
36,00€	Kg	ff	sub

1 000 pastile de 5 g de contragreutăți din fier
Autoadezive cu 4mm de grosime
Dimensiunile suportului: 29,5 cm x 29,5 cm
Greutate : 5,865 kg
Cu magnet pentru reținerea resturilor



CHEIE PENTRU REPARAT FILET VENTIL

52652	0,03	25	100	7.200
2,80€	Kg	sub	ff	



52651	0,06	25	100
3,89€	Kg	sub	ff



UTIL PENTRU VENTILE

52653	0,04	10	250	6.000
3,00€	Kg	sub	ff	



Pentru montarea și demontarea ventilelor

CONTRAGREUTĂȚI

JBM

SET REPARATIE VALVES TPMS

ACOPERĂ 95% DIN VEHICULELE DE PE PIATA
Cererile sunt disponibile pe site-ul nostru web:
www.jbmcamp.com

52855	1,63	6	156
372,60€			



INCLUDE



PIESE DISPONIBILE

12909
5,70€ 4.25 Nm x8



OE 72-20-207, TPK65656

12905
5,70€ 6 Nm x8



OE 72-20-208, TPK65657

12913
5,70€ 8 Nm x8



OE 72-20-209, TPK65658

12903
5,70€ 8 Nm x8



OE 72-20-219, TPK66138

12912
5,70€ 8 Nm x8



OE 72-20-212, TPK65961

12911
5,70€ 6 Nm x8



TPK65962

12907
5,70€ 8 Nm x8



OE 72-20-210, TPK65659

12906
5,70€ 8 Nm x8



OE 72-20-216, TPK66070, 7020K

12904
5,70€ 6 Nm x8



OE 72-20-211, TPK65660

12916
6,50€ 1.4 Nm (nut) x4



OE 72-20-101

12919
9,80€ 4 Nm x4



OE 72-20-103, TPK65731

12922
9,80€ 6.0 Nm x4



OE 72-20-403, TPK43171

12921
9,80€ 6.0 Nm x4



OE 72-20-105, TPK43148

12917
9,80€ 6 Nm x4



OE TPK66086

12914
9,80€ 8 Nm x4



OE 72-20-422

1-1400-1

12948 **22,28€**



x100

2-128

12949 **22,28€**



x100

ACCESORII, DE ASEMENEA, DISPONIBILE

12902 x4
5,70€ 4.25 Nm

OE 72-20-223



12908 x4
5,70€ 4.25 Nm

OE 72-20-205,
TPK65654



12910 x4
5,70€ 7.5 Nm

OE 72-20-206,
TPK65655



12915
15,50€ 8 Nm (nut)
1.4 Nm (screw)

OE 72-20-116

x4



12918 x4
9,80€ 6 Nm

OE 72-20-102,
TPK65661



12920
9,80€ 4 Nm (nut)
4 Nm (screw)

x4



12923 x4
9,80€ 8 Nm

OE TPK43211



12924
5,70€ 4.0 Nm (nut)
1.4 Nm (screw)

x4



12925
9,80€ x4



fără TVA

JBM

WWW.JBMCAMP.COM

JBM
2018

231

SUPAPE TPMS

JBM

KIT DE SCULE PENTRU MONTAJ ȘI DEMONTAJ DE SUPAPE TPMS

52818	1,38	10
168,00€	Kg	ff

Set de mai multe instrumente, proiectate pentru a facilita montajul și demontajul senzorilor TPMS. Dispune de toate sculele de care operatorul are nevoie pentru a efectua schimbul de formă rapidă, cu minimul efort și totală siguranță.



- ① 2-14 Nm
- ② 0,5-3,5 Nm
- ③ 2 x 11, 12mm
- ④ 3 x T10, T15, T20
- ⑤ 150 mm
- ⑥ 2 mm
- ⑦ 0,25 Nm
- ⑧ 0,45 Nm



SENSOR TPMS

EU-PRO 1

52856	0,04	4	1.500
62,00€	Kg	ff	ff

Programare ușoară.
Folosește pentru 98% din flota vehiculelor de pe piață.

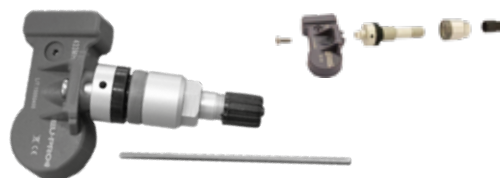

EU-PRO 2

53157	0,04	50	1.000
62,00€	Kg	ff	ff

Programare ușoară.
Folosește pentru 98% din flota vehiculelor de pe piață.

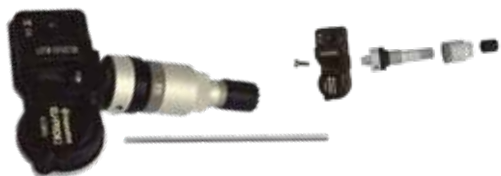

SENȘOR TPMS SUPAPĂ DE CAUCIUC



EU-PRO 1

53424	0,04	4
62,00€	Kg	ff

Este nevoie de un instrument de diagnosticare TPMS pentru a configura senzorul pentru vehiculul necesar.

Ușor de programare.
Util pentru 98% din flota de vehicule de pe piață.

Pereche de fructe cu coajă: dantelă
Cuplu: 1.4Nm



EU-PRO 2

53425	0,04	4
62,00€	Kg	ff

Ușor de programare.
Util pentru 98% din flota de vehicule de pe piață.

Pereche de fructe cu coajă: dantelă
Cuplu: 1.4Nm



VALVE PENTRU ANVELOPE

TR413

51741	0,01
0,32€	Kg
100	ff
1.000	ff
48.000	ff



TR414

51742	0,01
0,39€	Kg
100	ff
1.000	ff
48.000	ff



TR418

51743	0,02
0,51€	Kg
100	ff
1.000	ff
48.000	ff



SCULE REPARAȚIE ANVELOPE

52654	0,24	25	100	800
6,00€	Kg	ff	ff	ff

Vârf allen de: 4 - 3 - 2,5 - 2mm
Chei 12 fețe de: 9, 10, 12, 13, 15mm
Vârf stelat PH1
Vârf lat SL1
Vârf allen 5 - 6mm
Tubulară de 6mm de diametru



UTIL DIN METAL PENTRU VALVULE PNEUMATICE

METAL

52649	0,32
5,00€	Kg
10	ff
20	ff
2.250	ff

PLASTIC

52650	0,32
5,00€	Kg
10	ff
20	ff
2.250	ff



Pentru instalarea valvulelor pneumatice la autovehicule

ROLL STRIAT PENTRU REPARAREA PNEURILOR

52842	0,15
6,70€	Kg
10	ff
100	ff
1.500	ff



38mm

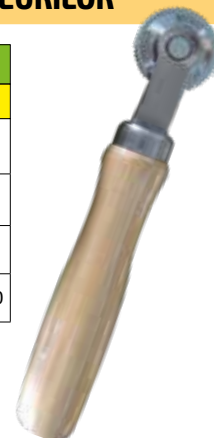

SET REPARAȚIE ANVELOPE

52662	0,66	20	440
30,70€	Kg		



- 1 x Burghiu de perforare
- 1 x Burghiu de introducere de fitil
- 1 x Util pentru a umfla anvelope
- 4 x Sticle de aer comprimat 16gr
- 1 x Cuter
- 10 x Fitile
- 1 x Cheie pentru reparat filet ventil

52663	1,23	10	320
27,10€	Kg		



- 1 x Burghiu de perforare
- 1 x Burghiu de introducere de fitil
- 1 x Capăt pentru burghiu de introducere de fitil
- 1 x Cuter
- 20 x Fitile
- 1 x Lubrifiant

FITILE DE SCHIMB PENTRU
REF. 52662/52663

12973	
0,58€	

x5

MELC DE PERFORARE
REF. 52663

13806	
9,80€	

N

MELC DE INSERȚIE PENTRU
FITILE REF. 52663

13805	
9,80€	

N

SCULĂ PT. SCHIMBAT ANVELOPE

52657	0,18	20	800
37,90€	Kg		



52658	0,16	20	800
37,90€	Kg		



52659	0,26	20
37,90€	Kg	



PÂRGHIE PT. SCOATEREA ANVELOPEI

52655	0,39	25	1.500
34,30€	Kg		



52656	0,40	20
25,60€	Kg	



LEVIER PENTRU VULCANIZARE

51362	0,19	5	20	500
3,00€	Kg			

18" x 5/8

51358	0,50	6	24	500
7,50€	Kg			

24" x 3/4

51359	0,66	6	24	500
8,00€	Kg			

24" x 3/4



PENTRU PNEURI

CHEIE ÎN CRUCE LEGĂTURA SUDATĂ

51661	1,17	20	480	1/2"
8,90€	Kg	ff	ff	

17, 19, 21mm

↔355mm↔

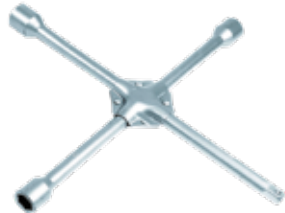

52881	1,40	10	420	1/2"
11,90€	Kg	ff	ff	

17, 19, 21, 22mm

↔400mm↔

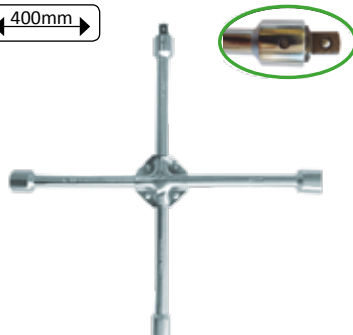

52880	3,75	5	100	3/4"
24,90€	Kg	ff	ff	

24, 27, 32mm

↔700mm↔



CHEIE EXTENSIBILĂ PENTRU ROȚI CU TUBULARĂ REVERSIBILĂ

51416	1,09	10	20	600	330-490mm	1/2"
8,90€	Kg	sub	ff	ff		



Torx cromată
17mm /19mm



Tubulară cromată
21mm /23mm

LEVIER PENTRU SCHIMBUL ROȚILOR MARI

52664	12,30	2	18
198,00€	Kg	ff	ff



CĂRUCIOR ROȚI PNEUMATICE

52660	7,88	1	18
68,00€	Kg	ff	ff

100Kg



CAPACITATE MARE

52661	19,40	1	10
225,00€	Kg	ff	ff

300Kg



APARAT PT. MONTAT ANVELOPELE PE JANTE

52552	10
208,00€	

Kg	10
ff	1
ff	15

IBL



DUZĂ REZERVA
PENTRU 52552

13741 21,00€



SET DE 3 PROTECTOARE DE JANTE

N

53419	
7,90€	
Kg	0,10
5.6	10
11	100
600	600

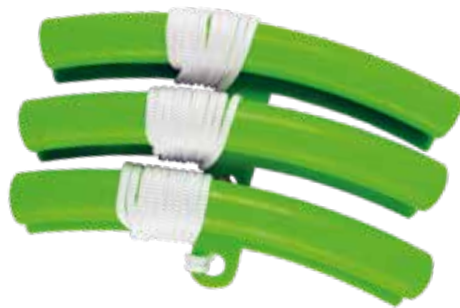

SET DE CAPACE ȘI FILTRE PENTRU VENTIL

52673	0,23	25	875
18,00€	Kg	5.6	11



INCLUDE

- 11903** Pungă cu 16u. capace din aluminiu pt. ventil
5,00€
- 11904** Pungă cu 50u. capace verzi din plastic pt. ventil
1,60€
- 11905** Pungă cu 50u. capace negre din plastic pt. ventil
1,40€
- 11906** Pungă cu 50u. filtre standard pt. ventil
6,00€
- 11907** Pungă cu 50u. filtre mare presiune pt. ventil
11,00€
- 11960** Extractor filet ventil
1,50€

DE ASEMENEA DISPONIBILE

- 11900** Capac din aluminiu pt. valvula pneumatică
2,80€
- 11901** Capac din plastic verde pt. valvula pneum.
1,60€
- 11902** Capac din plastic negru pt. valvula pneum.
1,60€

DISPOZITIV FIXARE BURDUF PLANETARĂ

52829	0,43	10	20	200
18,00€	Kg	5.6	11	600

ÎN AFARA \varnothing 10cm INTERIOR \varnothing 9,5cm



DISPOZITIV PNEUMATIC FIXARE BURDUF PLANETAR

51861	4,08	2	32
148,00€	Kg	5.6	11



Material: Aluminiu
Deschidere de 20 la 100mm



KIT BURDUF PLANETARĂ UNIV. NEOPREN

PENTRU TURISME

51705	0,23	1	20	280
5,70€	Kg	5.6	11	600

13738 3,00€
BURDUF DE TRANSMISIE AUTOTURISM UNIVERSAL pt. 51705

PENTRU FURGON

51703	0,43	10	20	200
7,50€	Kg	5.6	11	600

13739 4,60€
BURDUF DE TRANSMISIE FURGONETĂ UNIVERSAL pt. 51703



SERIES SPECIALE PROMOȚIONALE BURDUF

N

SERIE124 20,94
398,00€ Kg



51861 x1

+



52633 x100

+



13738 x100

+

CV JOINT GREASE



13879 x100

SET BURDUF DE DIRECȚIE UNIVERSAL

52644 0,19 20 280
6,60€ Kg



NEOPREN

BURDUF CASEȚĂ DE
DIRECȚIE UNIVERSAL
REF. 52644

13740
4,50€



PENTRU PNEURI

CLEME

11891 x50
0,42€



15-45mm

11890 x50
0,54€



50-125mm

SET DE 2 CLEME

52633 4,08 2 32
0,80€ Kg

A SE UTILIZA CU CLEȘTI REF. 52619



15-45mm



50-125mm

CAP CENTRARE

52645 0,02 50 1.000
0,38€ Kg

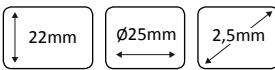

52645

52646 0,01 50 1.000
0,32€ Kg

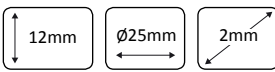

52646

53037 0,01 50 1.000
0,30€ Kg

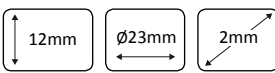

53037

53038 0,01 50 1.000
0,30€ Kg

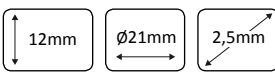

53038

53039 0,02 50 1.000
0,35€ Kg

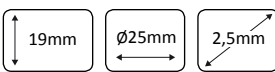

53039

53040 0,01 50 1.000
0,30€ Kg

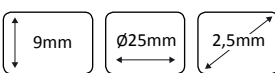

53040



RACORD FLEXIBIL EȘAPAMENT



DISPONIBILE ÎN
CASETA DE UNICĂ

REF.	DESCRIERE	Kg	11	€	
51706	Racord flexibil Ø 25mmL x 300mmL	0,28	25	1.500	18,00€
51707	Racord flexibil Ø 45mmL x 100mmL	0,29	25	1.200	10,50€
51708	Racord flexibil Ø 45mmL x 150mmL	0,35	25	900	14,00€
51709	Racord flexibil Ø 45mmL x 200mmL	0,49	25	750	16,46€
51710	Racord flexibil Ø 45mmL x 250mmL	0,61	25	600	20,62€
51711	Racord flexibil Ø 45mmL x 300mmL	0,77	25	450	24,08€
51712	Racord flexibil Ø 50mmL x 100mmL	0,26	25	700	12,00€
51713	Racord flexibil Ø 50mmL x 150mmL	0,42	25	700	14,78€
51714	Racord flexibil Ø 50mmL x 200mmL	0,57	25	600	19,69€
51715	Racord flexibil Ø 50mmL x 250mmL	0,75	25	350	23,17€
51716	Racord flexibil Ø 50mmL x 300mmL	0,86	25	450	27,86€
51717	Racord flexibil Ø 55mmL x 100mmL	0,34	25	700	13,99€
51718	Racord flexibil Ø 55mmL x 150mmL	0,47	25	450	16,90€
51719	Racord flexibil Ø 55mmL x 200mmL	0,61	25	350	22,93€
51720	Racord flexibil Ø 55mmL x 250mmL	0,83	25	350	25,76€
51721	Racord flexibil Ø 55mmL x 300mmL	0,99	25	300	29,07€
51722	Racord flexibil Ø 60mmL x 100mmL	0,34	25	700	16,31€
51723	Racord flexibil Ø 60mmL x 150mmL	0,48	25	500	19,68€
51724	Racord flexibil Ø 60mmL x 200mmL	0,65	25	400	24,69€
51725	Racord flexibil Ø 60mmL x 250mmL	0,88	25	300	31,94€
51726	Racord flexibil Ø 60mmL x 300mmL	1,16	25	250	32,21€
51727	Racord flexibil Ø 60mmL x 400mmL	1,62	25	250	39,80€

CATALIZATORI PENTRU BENZINĂ

CATALIZATOR UNIVERSAL LAT DE PÂNĂ LA 2.0CC



CATALIZATOR UNIVERSAL LAT DE LA 2.0CC PÂNĂ LA 7.0CC



CATALIZATOR UNIV. LAT DE LA 3.0CC PÂNĂ LA 7.0CC



CATALIZATOR UNIVERSAL ROTUND DE PÂNĂ LA 2.0CC



CATALIZATOR UNIV. LAT DE LA 2.0CC PÂNĂ LA 7.0CC,
2 INTRĂRI+1 IEȘIRE



CATALIZATOR UNIV. LAT DE LA 3.0CC PÂNĂ LA 7.0CC,
2 INTRĂRI + 2 IEȘIRI



CATALIZATOR UNIVERSAL LAT DE PÂNĂ LA 2.0CC



CATALIZATOR UNIVERSAL ROTUND DE PÂNĂ LA 2.0CC



REF.	DESCRIERE	Kg	11	€
50904	CATALIZATOR DIESEL TUR TDI	1,76	1	158,00€
50905	CATALIZATOR DIESEL LAT KD3N 82527	1,57	1	156,00€
51548	CATALIZATOR UNIV. LAT DE LA 2.0CC PÂNĂ LA 7.0CC	3,15	1	315,00€
51549	CATALIZATOR UNIV. LAT DE LA 2.0CC PÂNĂ LA 7.0CC	3,12	1	315,00€
51550	CATALIZATOR UNIV. LAT DE LA 2.0CC PÂNĂ LA 7.0CC	3,55	1	344,00€
51551	CATALIZATOR UNIV. LAT DE LA 3.0CC PÂNĂ LA 7.0CC	3,00	1	252,00€
51555	CATALIZATOR UNIVERSAL LAT DE PÂNĂ LA 2.0CC	2,18	1	154,00€
51556	CATALIZATOR UNIV. ROTUND DE PÂNĂ LA 2.0CC	1,80	1	154,00€
51557	CATALIZATOR UNIVERSAL LAT DE PÂNĂ LA 2.0CC	2,13	1	154,00€
51558	CATALIZATOR UNIVERSAL ROTUND DE PÂNĂ LA 2.0CC	1,84	1	154,00€
51583	CATALIZATOR DIESEL LAT standard	1,85	1	166,00€

PENTRU DIESEL

TUR TDI



LAT



LAT





14



CONSUMABILE

CLIPSURI	239
CONDUCTORI	239
CHAVETAS	240
SCREWS ȘI NUTS	240
RIVETS	242
SPĂLĂTORI	243
CLAMPS	246
O-RINGS	247
TUBURI DE TERMORETRACTIC	248
GREASERI	248
FUSE	249
TERMINALE	250
PLASTIC CLIPS	251

TRUSĂ DE CLIPSURI TIP "E"

N

53348	0,33	6	24	150 PCS	
8,10€	Kg				



	M1.5	M3	M5	M6	M9	M12	M15	M19	M22
	15 PCS	15 PCS	20 PCS	25 PCS	25 PCS	20 PCS	10 PCS	10 PCS	10 PCS

TRUSĂ DE CONDUCTORI DE GUMĂ

N

53349	0,25	6	24	125 PCS	
7,90€	Kg				



19,5x23	16x24	13x15	11,5x19	10x20	10x12	25	22	19	15
2 PCS	3 PCS	3 PCS	4 PCS	3 PCS	5 PCS	2 PCS	3 PCS	4 PCS	5 PCS
	9,8x11,5	8x14	7,5x13	6x7,5	3,5x6	12	9	7	
	6 PCS	3 PCS	7 PCS	10 PCS	15 PCS	10 PCS	20 PCS	20 PCS	

TRUSĂ DE CONECTORI DE GUMĂ

N

53370	1,50	6	24	190 PCS	
19,40€	Kg				



	M2	M3	M4	M5	M6	M8	M10
	25 PCS	25 PCS	30 PCS	30 PCS	30 PCS	20 PCS	20 PCS

TRUSĂ DE CONDUCTORI ELASTICI

N

53350	0,38	6	24	120 PCS	
9,85€	Kg				



1/16x3/16	4u.	5/64x1	4u.	1/8x1	5u.	3/16x5/8	5u.
1/16x5/16	4u.	3/32x5/8	4u.	1/8x1-1/4	5u.	3/16x1	5u.
1/16x3/4	4u.	3/32x1	4u.	5/32x5/8	4u.	3/16x1-1/4	5u.
5/64x1/4	4u.	3/32x1-1/4	4u.	5/32x1	4u.	7/32x5/8	4u.
5/64x1/2	4u.	1/8x5/8	5u.	5/32x1-1/2	4u.	7/32x1-1/4	4u.
						7/32x1-3/4	4u.
						1/4x5/8	4u.
						1/4x1-1/4	4u.
						1/4x1-3/4	4u.
						5/16x3/4	4u.
						5/16x1-1/2	4u.
						5/16x2	4u.
						3/8x3/4	2u.
						3/8x1-1/2	2u.
						3/8x2	2u.

SET SPLINTURI

52027	1,02
14,00€	
Kg	
	5
	690

385
PCS



MĂSURI	UDS.	MĂSURI	UDS.
1,2x25mm	50	3,2x50mm	50
1,6x32mm	50	4x50mm	40
2x40mm	50	5x63mm	10
2,5x40mm	50	6,3x63mm	15
3,2x40mm	50		

TRUSĂ DE CHEI

N

53372	1,58	6	12	144 PCS
10,95€	Kg			



	M3x50	M4x60	M5x75
	50 PCS	30 PCS	20 PCS
	M6x50	M6x75	M8x60
	20 PCS	16 PCS	8 PCS

TRUSĂ DE CONECTORI CU INEL

N

53371 1,50 6 12 50
21,30€ Kg sub ft PCS

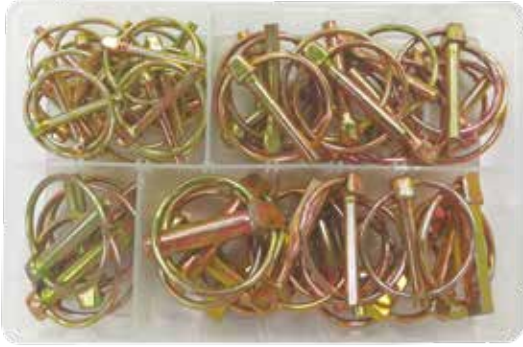

	5x36	6x45	8x45	11x45
	16 PCS	18 PCS	6 PCS	10 PCS

SET SPLINTURI "R"

52044 22,00€

Kg 0,68
ft 20
400

150 PCS



REF.	MĂSURI	UDS.	€/U.
10882	2,00x32mm	42	0,11€
10883	1,60x36mm	30	0,10€
10884	1,60x42mm	25	0,11€
10793	2,30x43mm	25	0,14€
10794	3,20x52mm	20	0,26€
10795	3,80x75mm	8	0,42€

PIESE DISPONIBILE

TRUSĂ DE ȘURUBURI DE CÂRLIG

N

53352 0,67 6 24 151
9,60€ Kg sub ft PCS



	2,4x25	4x45	4x50		2,4x41	4x64	4,2x85
	60 PCS	12 PCS	12 PCS		50 PCS	12 PCS	5 PCS

TRUSĂ DE CONECTORI CLEVIS ȘI SPLINTURI "R"

N

53363 1,18 6 12 71
19,85€ Kg sub ft PCS



	8x50	9.5x50	11x63	12.5x50		3.5x44	2.5x42	2.5x58	2x3
	5 PCS	18 PCS	5 PCS	3 PCS		6 PCS	20 PCS	7 PCS	7 PCS

TRUSĂ CU CHEI

N

53364 0,79 6 12 106
10,00€ Kg sub ft PCS



	3x3x25	3x3x20	5x5x30	5x5x25	5x5x20	6x6x40	6x6x30
	4 PCS	4 PCS	5 PCS	5 PCS	5 PCS	5 PCS	5 PCS
	6x6x20	8x8x40	8x8x30	10x10x40	10x10x30	12x12x40	2 PCS
	5 PCS	5 PCS	5 PCS	5 PCS	5 PCS	2 PCS	

TRUSĂ DE ȘURUBURI ȘI PIULIȚE

N

53351 0,92 6 12 240
9,60€ Kg sub ft PCS



	4x12	4x20	5x16	5x25		4	5	6	8	10
	10 PCS	10 PCS	10 PCS	10 PCS		20 PCS	20 PCS	20 PCS	10 PCS	10 PCS
	6x20	6x30	8x25	8x40		4	5	6	8	10
	10 PCS	10 PCS	5 PCS	5 PCS		20 PCS	20 PCS	20 PCS	10 PCS	10 PCS
	10x16	10x40				4	5	6	8	10
	5 PCS	5 PCS				20 PCS	20 PCS	20 PCS	10 PCS	10 PCS

TRUSĂ DE ȘURUBURI AUTOFILETANTE

N

53354	0,58	6	24	200 PCS	
9,85€	Kg				



#8x12.5	#8x16	#8x19	#8x25	#10x12.5	#10x16	#10x19	#10x25
30 PCS	30 PCS	30 PCS	30 PCS	20 PCS	20 PCS	20 PCS	20 PCS

TRUSĂ DE ȘURUBURI ALLEN

N

53362	0,63	6	24	106 PCS
9,05€	Kg			



4x12	5x12	5x25	10x40	6x25	8x40	10x25	6x12	8x25
25 PCS	25 PCS	20 PCS	3 PCS	10 PCS	5 PCS	3 PCS	10 PCS	5 PCS

TRUSĂ CU ȘURUBURI ȘI PIULIȚE TIP U

N

53366	0,29	6	24	170 PCS	
8,85€	Kg				



	#6x5/16	#8x5/8	#6	#6	#8
	40 PCS	20 PCS	20 PCS	20 PCS	20 PCS
	#10x1/2	1/4x3/4	1/4	#10	
	15 PCS	10 PCS	10 PCS	15 PCS	

TRUSĂ DE ȘURUBURI

N

53369	0,79	6	24	550 PCS	
10,40€	Kg				



4x1/2"	4x5/8"	6x3/8"	6x1/2"	6x5/8"	6x3/4"	8x1/2"
65 PCS	55 PCS	60 PCS	65 PCS	60 PCS	45 PCS	50 PCS
8x5/8"	8x1"	8x1-1/4"	10x3/4"	10x1"	10x1-1/4"	
40 PCS	30 PCS	20 PCS	25 PCS	20 PCS	15 PCS	

SET PIULIȚE AUTOBLOCANTE

52029	1,02	5	360	228 PCS
14,00€	Kg			



MĂSURI	UDS.	MĂSURI	UDS.
M3	50	M10	15
M4	50	M12	10
M5	40	M14	8
M6	30	M16	5
M8	20		

SET PIULIȚE

52028	1,05	5	360	243 PCS
9,50€	Kg			



REF.	MĂSURI	UDS.	€/u.	REF.	MĂSURI	UDS.	€/u.
10805	M3	50	0,05€	10785	M10	20	0,05€
10779	M4	50	0,01€	10786	M12	10	0,10€
10780	M5	50	0,01€	10812	M14	8	0,20€
10781	M6	30	0,02€	10813	M16	5	0,25€
10784	M8	20	0,02€				

PIESE DISPONIBILE

TRUSĂ CU PIULIȚE FLUTURE

N

53365	0,75	6	12	150 PCS	
11,10€	Kg				



	M4 40 PCS	M5 40 PCS	M6 25 PCS	M8 25 PCS	M10 20 PCS
--	------------------------	------------------------	------------------------	------------------------	-------------------------

TRUSĂ DE PIULIȚE DE NIT DE ALUMINIU

N

53361	0,46	6	24	150 PCS	
15,90€	Kg				



3x9 40 PCS	4x11 35 PCS	5x13 25 PCS	6x15 25 PCS	8x18 15 PCS	10x21 10 PCS
-------------------------	--------------------------	--------------------------	--------------------------	--------------------------	---------------------------

SET PIULIȚE NIT POP

52703	0,79	5	20	800	235 PCS
19,00€	Kg				



M3 50 PCS	M4 50 PCS	M5 50 PCS	M6 40 PCS	M8 20 PCS	M10 15 PCS	M12 10 PCS
------------------------	------------------------	------------------------	------------------------	------------------------	-------------------------	-------------------------

➤ **PIESE DISPONIBILE**

TRUSĂ DE PIULIȚE DE NIT

N

53360	0,63	24	150 PCS	
11,75€	Kg			



3x9 40 PCS	4x11 35 PCS	5x13 25 PCS	6x15 25 PCS	8x18 15 PCS	10x21 10 PCS
-------------------------	--------------------------	--------------------------	--------------------------	--------------------------	---------------------------

SET POPNITURI

52043	0,98	20	480	300 PCS
17,00€	Kg			



REF.	MĂSURI	UDS.	€/u.
10877	4,8x16,90mm	50	0,12€
10878	4,8x24,80mm	40	0,15€
10879	3,2x9,70mm	90	0,09€
10880	4,8x12,70mm	70	0,11€
10881	4,8x20,00mm	50	0,13€

➤ **PIESE DISPONIBILE**

SET POPNITURI DIN PLASTIC

52711	0,44	48	384	150 PCS
22,00€	Kg			



6 x 19.3mm (25 uds), 6 x 17.9mm (25 uds),
6 x 25.5mm (25 uds), 6 x 24.5mm (25 uds),
6 x 24mm (25 uds), 6 x 24mm (25 uds)

DE NITUIT PNEUMATICĂ DISPONIBILE ÎN PAG. 42 (REF. 52575)

TRUSĂ CU IMBUSURI ASORTATE

N

53379	0,63	6	24	1000 PCS
12,10€	Kg			



 60 PCS	 40 PCS	 1.5x12mm 150 PCS	 2.4x30 35 PCS	 2.5x30 30 PCS	 2.5x40 25 PCS
 5/8" 60 PCS	 3/4" 40 PCS	 2x30mm 55 PCS	 10mm 45 PCS	 1.20x20 220 PCS	 1.4x25 120 PCS
				 2x38 40 PCS	 1.6x30 80 PCS

TRUSĂ ASORTIMENT DE ȘURUBURI, PIULIȚE ȘI ȘAIBE

51804	5,68	5	120	828 PCS
47,00€	Kg			



REF.	SPECIFICAȚII	Kg	UDS.	€/u.
10772	Șurub zincat DIN 933 8.8 M4x25	0,01	25	0,02€
10773	Șurub zincat DIN 933 8.8 M5x50	0,01	25	0,05€
10774	Șurub zincat DIN 933 8.8 M6x50	0,01	25	0,08€
10775	Șurub zincat DIN 933 8.8 M7x50	0,01	15	0,12€
10776	Șurub zincat DIN 933 8.8 M8x50	0,01	15	0,16€
10777	Șurub zincat DIN 933 8.8 M10x50	0,04	12	0,19€
10778	Șurub zincat DIN 933 8.8 M12x60	0,05	20	0,32€
10779	Piuliță zincată DIN 934 M4	0,02	50	0,01€
10780	Piuliță zincată DIN 934 M5	0,01	50	0,01€
10781	Piuliță zincată DIN 934 M6	0,01	50	0,02€
10782	Piuliță zincată DIN 934 M7	0,01	50	0,02€



PIESE DISPONIBILE

REF.	SPECIFICAȚII	Kg	UDS.	€/u.
10784	Piuliță zincată DIN 934 M8	0,01	50	0,02€
10785	Piuliță zincată DIN 934 M10	0,01	50	0,05€
10786	Piuliță zincată DIN 934 M12	0,01	40	0,10€
10787	Șaibă zincată DIN 125 M4	0,01	50	0,01€
10788	Șaibă zincată DIN 125 M5	0,01	50	0,01€
10789	Șaibă zincată DIN 125 M6	0,01	50	0,01€
10790	Șaibă zincată DIN 125 M7	0,01	50	0,02€
10791	Șaibă zincată DIN 125 M8	0,01	50	0,03€
10792	Șaibă zincată DIN 125 M10	0,01	50	0,04€
10783	Șaibă zincată DIN 125 M12	0,01	50	0,04€
50959	Cutie din plastic cun 19 comp.	0,7	1	12,40€

TRUSĂ CU ȘAIBE DIN FIER GALVANIZAT

52158	3,45	5	40	475 PCS
34,00€	Kg			



MĂSURI	UDS.
5x20x1,5mm	50
6x20x1,5mm	50
7x20x1,5mm	50
8x20x1,5mm	50
8x25x1,75mm	50
10x30x2,5mm	25
6x30x2mm	25
7x30x2mm	25
8x30x2mm	25
4x11x0,98mm	50
14x40x3mm	25
4x20x1,5mm	50

TRUSĂ DE ȘAIBE DE FIER SUPRADIMENSIONATE



53377 1,58 6 12
16,00€ Kg sub ft **240 PCS**



20x6x1.5 20 PCS	20x8x1.5 20 PCS	20x10x1.5 20 PCS	25x6x1.5 20 PCS	25x8x1.5 20 PCS	25x10x1.5 20 PCS
32x2x1.5 20 PCS	32x4x1.5 20 PCS	32x6x1.5 20 PCS	32x8x1.5 20 PCS	32x10x1.5 20 PCS	32x10x1.5 20 PCS

TRUSĂ CU ȘAIBE 18 ALUMINIU

52031 0,57 24 384
34,00€ Kg ft **900 PCS**



MĂSURI	MĂSURI	MĂSURI
3x7x1,5mm	6x10x1,5mm	9x12x1,5mm
4x8x1,5mm	6x11x1,5mm	10x14x1,5mm
5x6x1,5mm	7x11x1,5mm	11x16x1,5mm
16x22x1,5mm	7x12x1,5mm	11x17x1,5mm
14x22x1,5mm	8x12x1,5mm	12x16x1,5mm
14x20x1,5mm	8x14x1,5mm	12x18x1,5mm

TRUSĂ CU ȘAIBE GROVER NEGRE

52032
22,00€
 Kg 1,68
 ft 5
 870
1.735 PCS



MĂSURI	UDS.	MĂSURI	UDS.
3mm	600	10mm	65
4mm	400	12mm	50
5mm	220	14mm	40
6mm	220	16mm	30
8mm	110		

TRUSĂ DE ȘAIBE DE CUPRU PENTRU INJECTOARE



53229 0,40 5 20
27,90€ Kg sub ft **150 PCS**



13.8x7.3x1.4mm 10 PCS	15.0x7.0x2.0mm 10 PCS	15.0x7.5x2.5mm 10 PCS	16.0x7.5x1.7mm 10 PCS	16.0x7.5x2.0mm 10 PCS
14.6x7.5x1.3mm 10 PCS	15.0x7.5x1.0mm 10 PCS	15.0x7.5x2.0mm 10 PCS	15.0x7.5x3.0mm 10 PCS	16.0x7.5x1.5mm 10 PCS
14.6x7.5x3.0mm 10 PCS	15.0x7.5x1.5mm 10 PCS	15.5x7.5x2.0mm 10 PCS	16.4x7.5x2.0mm 10 PCS	20.0x9.4x0.9mm 10 PCS

TRUSĂ DE ȘAIBE DE CUPRU PENTRU INJECTOARE



53340 0,90 10
67,35€ Kg ft **375 PCS**



13819 5,20€ 50 13.8 x 7.3 x 1.4 mm	13824 6,50€ 50 15.0 x 7.5 x 1.5 mm	13829 7,90€ 50 16.0 x 7.5 x 1.5 mm
13820 5,50€ 50 14.6 x 7.5 x 1.3 mm	13825 8,60€ 50 15.0 x 7.5 x 2.0 mm	13830 8,95€ 50 16.0 x 7.5 x 1.7 mm
13821 11,35€ 50 14.6 x 7.5 x 3.0 mm	13826 10,70€ 50 15.0 x 7.5 x 2.5 mm	13831 10,30€ 50 16.0 x 7.5 x 2.0 mm
13822 8,95€ 50 15.0 x 7.0 x 2.0 mm	13827 12,75€ 50 15.0 x 7.5 x 3.0 mm	13832 10,66€ 50 16.4 x 7.5 x 2.0 mm
13823 4,45€ 50 15.0 x 7.5 x 1.0 mm	13828 9,25€ 50 15.5 x 7.5 x 2.0 mm	13833 7,20€ 50 20.0 x 9.4 x 0.9 mm

TRUSĂ CU ȘAIBE 18 CUPRU

52030	1,21	12	384		900 PCS
68,00€	Kg				



REF.	MĂSURI	€/U.
10823	3x7x1,5mm	0,09€
10824	4x8x1,5mm	0,09€
10825	5x6x1,5mm	0,09€
10826	16x22x1,5mm	0,19€
10827	14x22x1,5mm	0,23€
10828	14x20x1,5mm	0,23€
10829	6x10x1,5mm	0,09€
10830	6x11x1,5mm	0,09€
10831	7x11x1,5mm	0,09€

REF.	MĂSURI	€/U.
10832	7x12x1,5mm	0,09€
10833	8x12x1,5mm	0,09€
10834	8x14x1,5mm	0,12€
10835	9x12x1,5mm	0,12€
10836	10x14x1,5mm	0,16€
10837	11x16x1,5mm	0,16€
10838	11x17x1,5mm	0,16€
10839	12x16x1,5mm	0,19€
10840	12x18x1,5mm	0,12€



TRUSĂ ȘAIBE DIN CUPRU

52163	0,65	20	360		525 PCS
58,00€	Kg				



ȘAIBĂ DIN CUPRU



REF.	Gr.				€/U.
51538	∅ 10mm / 0,01kg	0,01	100	-	0,10€/u.
51539	∅ 12mm / 0,01kg	0,01	100	31.000	0,12€/u.
51540	∅ 14mm / 0,01kg	0,01	100	20.000	0,14€/u.
51541	∅ 16mm / 0,01kg	0,01	100	25.000	0,12€/u.
51542	∅ 18mm / 0,01kg	0,01	100	-	0,14€/u.
51543	∅ 20mm / 0,01kg	0,01	100	-	0,18€/u.
51544	∅ 22mm / 0,02kg	0,01	100	-	0,26€/u.
51545	∅ 26mm / 0,02kg	0,01	100	-	0,31€/u.

REF.	MĂSURI	UDS.
51538	∅ 10mm	100
51539	∅ 12 mm	100
51540	∅ 14 mm	100

REF.	MĂSURI	UDS.
51541	∅ 16 mm	100
51542	∅ 18 mm	100
51543	∅ 20 mm	25

COMPRESIBIL



ȘAIBĂ DIN CUPRU METALOPLASTICĂ



	∅ 10mm / 0,02kg				
	52719	0,04			
	0,19€/u.	Kg			

	∅ 13mm / 0,01kg				
	51554	0,01			
	0,28€/u.	Kg			

	∅ 12mm / 0,03kg				
	51843	0,01			
	0,19€/u.	Kg			

	∅ 14mm / 0,01kg				
	51546	0,01			
	0,19€/u.	Kg			

	∅ 16mm / 0,01kg				
	51799	0,01			
	0,19€/u.	Kg			

TRUSĂ DE ȘAIBE DE CUPRU

N

53353	0,29	6	24	110 PCS	
15,15€	Kg				



	M6 30 PCS	M8 25 PCS	M10 20 PCS	M12 15 PCS	M14 10 PCS	M16 10 PCS
--	------------------------	------------------------	-------------------------	-------------------------	-------------------------	-------------------------

TRUSĂ DE ȘAIBE DINȚATE INTERIOR

N

53373	0,25	6	24	260 PCS	
10,95€	Kg				



	M3x50 50 PCS	M4x60 30 PCS	M5x75 20 PCS	M6x50 20 PCS	M6x75 16 PCS	M8x60 8 PCS	M8x60 8 PCS
--	---------------------------	---------------------------	---------------------------	---------------------------	---------------------------	--------------------------	--------------------------

TRUSĂ DE ȘAIBE SEGER EXTERIOARE

N

53383	0,29	6	24	300 PCS	
7,15€	Kg				



	M4 50 PCS	M6 40 PCS	M8 45 PCS	M10 30 PCS	M12 30 PCS
	M14 25 PCS	M16 25 PCS	M18 25 PCS	M20 15 PCS	M22 15 PCS

TRUSĂ DE ȘAIBE SEGER INTERIOARE

N

53382	0,33	6	24	300 PCS	
7,15€	Kg				



	M4 50 PCS	M6 40 PCS	M8 45 PCS	M10 30 PCS	M12 30 PCS
	M14 25 PCS	M16 25 PCS	M18 25 PCS	M20 15 PCS	M22 15 PCS

ASORTIMENT DE ȘAIBE DE FIBRĂ

N

53381	0,25	5	24	600 PCS
11,75€				
Kg				



	10x5.5x1 160 PCS	16x10x1 80 PCS	19x12x1 40 PCS	22x16x1 30 PCS	22.5x14x1 20 PCS	32x22x1 20 PCS
	12x6.5x1 100 PCS	16x8x1 60 PCS	20x12.5x1 40 PCS	27x20x1 20 PCS	25.4x17.5x1 15 PCS	32x24x1 15 PCS

ASORTIMENT DE COLIERE DE FURTUN

N

53378	0,29	6	24	20 PCS	
11,10€	Kg				





	1" 4 PCS	1-1/4" 2 PCS	1-3/4" 2 PCS	2" 4 PCS	2-1/2" 2 PCS	3" 2 PCS	3-1/2" 2 PCS	4" 2 PCS
--	-----------------------	---------------------------	---------------------------	-----------------------	---------------------------	-----------------------	---------------------------	-----------------------

TRUSĂ DE ORINGURI METRICE

METRICE - 386 UNITĂȚI

CAPACUL TRUSEI	Poziția trusă	006	007	008	009	010	011
	Lățime de cauciuc (mm)	2	2	2	2	2	2
	Ø interior (mm)	3	4	5	6	7	8
	Cantitate	16	16	16	16	16	16
CAPACUL TRUSEI	Poziția trusă	113	112	111	110	012	
	Lățime de cauciuc (mm)	2.5	2.5	2.5	2.5	2	
	Ø interior (mm)	14	12	11	10	10	
	Cantitate	13	13	13	13	17	
CAPACUL TRUSEI	Poziția trusă	114	115	116	210		
	Lățime de cauciuc (mm)	2.5	2.5	2.5	3		
	Ø interior (mm)	16	17	19	19		
	Cantitate	13	13	13	10		
BAZA TRUSEI	Poziția trusă	222	325	326	327		
	Lățime de cauciuc (mm)	3	4	4	4		
	Ø interior (mm)	38	38	41	44		
	Cantitate	12	10	9	9		
BAZA TRUSEI	Poziția trusă	221	220	219	218	217	
	Lățime de cauciuc (mm)	3	3	3	3	3	
	Ø interior (mm)	36	35	33	32	30	
	Cantitate	12	12	12	12	12	
BAZA TRUSEI	Poziția trusă	211	212	213	214	215	216
	Lățime de cauciuc (mm)	3	3	3	3	3	3
	Ø interior (mm)	20	22	24	25	27	28
	Cantitate	12	12	12	12	12	12

50651	
18,00€	
 0,58	
 20	
 360	

CALITATE NBR



INCI - 386 UNIDADES





CAPACUL TRUSEI	Poziția trusă	006	007	008	009	010	011
	Lățime de cauciuc (mm)	1/16	1/16	1/16	1/16	1/16	1/16
	Ø interior (mm)	1/8	5/32	3/16	7/32	1/4	5/16
	Cantitate	20	20	20	20	20	20
CAPACUL TRUSEI	Poziția trusă	113	112	111	110	012	
	Lățime de cauciuc (mm)	3/32	3/32	3/32	3/32	1/16	
	Ø interior (mm)	9/16	1/2	7/16	3/8	3/8	
	Cantitate	13	13	13	13	13	
CAPACUL TRUSEI	Poziția trusă	114	115	116	210		
	Lățime de cauciuc (mm)	3/32	3/32	3/32	1/8		
	Ø interior (mm)	5/8	11/16	3/4	3/4		
	Cantitate	13	13	13	10		
BAZA TRUSEI	Poziția trusă	222	325	326	327		
	Lățime de cauciuc (mm)	1/8	3/16	3/16	3/16		
	Ø interior (mm)	11/2	11/2	15/8	13/4		
	Cantitate	10	7	7	7		
BAZA TRUSEI	Poziția trusă	221	220	219	218	217	
	Lățime de cauciuc (mm)	1/8	1/8	1/8	1/8	1/8	
	Ø interior (mm)	17/16	13/8	15/16	11/4	13/16	
	Cantitate	10	10	10	10	10	
BAZA TRUSEI	Poziția trusă	211	212	213	214	215	216
	Lățime de cauciuc (mm)	1/8	1/8	1/8	1/8	1/8	1/8
	Ø interior (mm)	13/16	7/8	15/16	1	11/16	11/8
	Cantitate	10	10	10	10	10	10

50652	
18,00€	
 0,66	
 20	
 360	



CALITATE NBR

TRUSĂ ORINGURI / GARNITURI PENTRU AACC

50807	0,16	5	50	750	270 PCS
32,00€					



MĂSURI	UDS.
5.29x1.78	20
6.07x1.78	20
6.8x1.9	20
7.65x1.78	20
7.80x1.90	20
8.0x2.0	20
8.80x1.90	20
10.82x1.78	15
10.77x2.62	15

MĂSURI	UDS.
11.0x2.0	15
12.0x2.0	15
13.9x1.80	10
13.95x2.62	10
14.0x2.0	10
15.0x2.0	10
17.0x2.00	10
17.17x17.78	10
17.04x3.53	10

TRUSĂ DE MANȘOANE TERMORETRACTABILE



53374	0,13	6	24	127 PCS	
7,10€	Kg				



M2x40	30 PCS
M2.5x40	25 PCS
M3.5x40	20 PCS
M5x40	20 PCS
M7x80	16 PCS
M10x80	8 PCS
M13x85	8 PCS

53376	0,17	6	24	127 PCS	
7,45€	Kg				



TRUSA CONECTORI DE FURTUNE



53434	0,13	6	24	65 PCS	
12,95€	Kg				



4x28.7	3.9x30.8	10.4x44.4
10 PCS	5 PCS	10 PCS
7.9x38	4.7x38.9	5.2x33.9
10 PCS	5 PCS	10 PCS
		7x30
		10 PCS

TRUSĂ CAPETE GRESARE

52033	1,68	5	870	135 PCS
32,00€	Kg			



UNGHI 45°

REF.	MĂSURI	UDS.	€/U.
10871	6mm	20	0,20€
10872	8mm	15	0,35€
10873	10mm	10	0,35€

UNGHI DREPT

REF.	MĂSURI	UDS.	€/U.
10868	6mm	20	0,15€
10869	8mm	15	0,20€
10870	10mm	10	0,25€

UNGHI 90°

REF.	MĂSURI	UDS.	€/U.
10874	6mm	20	0,20€
10875	8mm	15	0,35€
10876	10mm	10	0,35€

ASORTIMENT DE NIPLURI DE GRESARE



53359	0,54	6	24	110 PCS	
12,75€	Kg				



	6x1	60 PCS		6x1	5 PCS		6x1	5 PCS
	8x1.25	10 PCS		8x1.25	5 PCS		8x1.25	5 PCS
	10x1.5	10 PCS		10x1.5	5 PCS		10x1.5	5 PCS

TRUSĂ DE ARCURI



53358	0,25	6	24
8,75€	Kg	sub	11

200
PCS

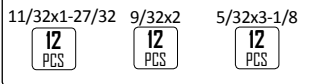
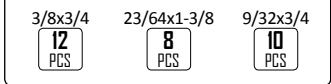
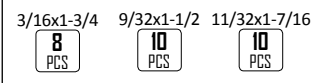
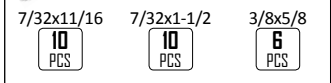
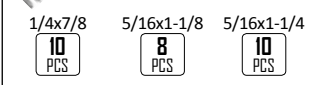
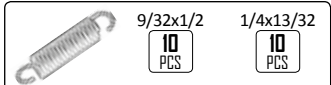
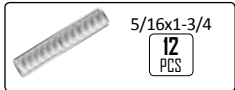

SET DE 2 CLEȘTI TIP CROCODIL



53357	0,04	6	24
3,60€	Kg	sub	11

2
PCS

30
AMP



TRUSĂ DE SIGURANȚE AUTO MINI



53355	0,17	6	24
9,30€	Kg	sub	11

120
PCS



	5A 20 PCS	10A 20 PCS	15A 20 PCS	20A 20 PCS	25A 20 PCS	30A 20 PCS
--	---------------------	----------------------	----------------------	----------------------	----------------------	----------------------

TRUSĂ DE SIGURANȚE AUTO



53356	0,17	6	24
9,50€	Kg	sub	11

120
PCS



	5A 20 PCS	10A 20 PCS		15A 20 PCS
--	---------------------	----------------------	--	----------------------

	20A 20 PCS	25A 20 PCS	30A 20 PCS
--	----------------------	----------------------	----------------------

TRUSĂ CU SIGURANȚE AUTO



53367	0,08	6	24
5,95€	Kg	sub	11

48
PCS



	5A 8 PCS	10A 8 PCS	15A 8 PCS		20A 8 PCS	25A 8 PCS	30A 8 PCS
--	--------------------	---------------------	---------------------	--	---------------------	---------------------	---------------------

TRUSĂ CU SIGURANȚE AUTO

N

53368

0,08	6	24	-
Kg	sub	ff	

5,50€

50
PCS



Mini siguranțe



5A	10A	15A	20A	25A	30A
8 PCS	8 PCS	8 PCS	8 PCS	8 PCS	10 PCS

TRUSĂ CU SIGURANȚE AUTO

N

53380

0,17	6	24
Kg	sub	ff

8,95€

120
PCS



5A	10A	15A	20A	25A	30A
20 PCS	20 PCS	20 PCS	20 PCS	20 PCS	20 PCS

TRUSĂ CU SIGURANȚE AUTO

52054

0,35	5	25	600
Kg	sub	ff	

19,00€

252
PCS



MINI XXA

REF.	CULOARE	PUTERE	UDS.	€/U.
10905	Blue	3A	20	0,12€
10906	Red	4A	20	0,12€
10907	Brown	5A	20	0,12€



STANDARD XXA

REF.	CULOARE	PUTERE	UDS.	€/U.
10914	Pink	4A	8	0,13€
10915	Yellow	5A	8	0,13€
12954	Purple	3A	8	0,13€



MINI XXA

REF.	CULOARE	PUTERE	UDS.	€/U.
10908	Yellow	7,5A	20	0,12€
10909	Pink	10A	20	0,12€
10910	Purple	15A	20	0,12€



STANDARD XXA

REF.	CULOARE	PUTERE	UDS.	€/U.
10916	Brown	7,5A	8	0,13€
10917	Red	10A	8	0,13€
10918	Blue	15A	8	0,13€



x20

PIESE DISPONIBILE



MINI XXA

REF.	CULOARE	PUTERE	UDS.	€/U.
10911	Yellow	20A	20	0,12€
10912	Grey	25A	20	0,12€
10913	Green	30A	20	0,12€



STANDARD XXA

REF.	CULOARE	PUTERE	UDS.	€/U.
10919	Yellow	20A	8	0,13€
10920	Grey	25A	8	0,13€
10921	Green	30A	8	0,13€

TRUSĂ CU PAPUCI ELECTRICI 635 PIESE

52053

0,60	5	20	840
Kg	sub	ff	

29,00€

635
PCS



REF.	MĂSURI	UDS.	€/U.
10885	RV1.25-4S	50	0,08€
10886	RV2-4S	50	0,08€
10887	RV2-6S	30	0,12€
10888	RV5.5-6S	20	0,16€
10889	RV5.5-5S	20	0,16€
10890	BV5.5	15	0,19€
10891	BV2	35	0,12€
10892	BV1.25	30	0,12€
10893	RV2-5S	40	0,12€

REF.	MĂSURI	UDS.	€/U.
10894	SV1-4S	50	0,08€
10895	SV2-4S	40	0,08€
10896	FDD1.25-250	45	0,12€
10897	MDD1.25-250	50	0,12€
10898	FDD2-250	40	0,12€
10899	MDD2-250	50	0,12€
10900	FDD5.5-250	25	0,12€
10901	MDD5.5-250	30	0,12€
10902	DFDN1.25-250	25	0,19€



x20

PIESE DISPONIBILE

TRUSĂ DE CLIPS DE PLASTIC

MAZDA

52896	0,17	6	24	190 PCS
	Kg	sub	ff	
24,30€				















	13104 1,85€ 8		13105 3,48€ 15		13106 1,85€ 8
OE 2042301		OE 999100402		OE B0016830200	
	13107 1,85€ 8		13108 4,63€ 20		13109 6,95€ 30
OE N30413356A		OE 992640543A		OE 99249051B	
	13110 3,48€ 15		13111 2,32€ 10		13112 1,39€ 6
OE 6508197AA		OE B1016825200		OE B09251833	
	13113 4,63€ 20		13114 4,63€ 20		13115 6,95€ 30
OE 992640543A		OE B45556741		OE G03158762	

TOYOTA / LEXUS

52886	0,18	6	24	504	150 PCS
	Kg	sub	ff		
21,60€					















	13002 2,95€ 8		13003 1,47€ 5		13004 3,68€ 10
OE 9018906001		OE 9046707138		OE 9046707117	
	13005 3,68€ 10		13006 1,84€ 5		13007 3,68€ 10
OE 9046709138		OE 9046709101		OE 75521611000	
	13008 2,95€ 8		13009 1,47€ 4		13010 2,95€ 8
OE 7503933060		OE 9017905060		OE 677711250	
	13011 1,84€ 5		13012 2,95€ 8		13013 2,95€ 8
OE 9046708124		OE 7539533030		OE 9046711063	

HONDA

52887	0,18	6	24	150 PCS
	Kg	sub	ff	
24,30€				









	13014 3,05€ 8		13015 1,27€ 15		13016 1,52€ 8
OE 75103514003		OE 9067558003		OE 915665P0003	
	13017 6,35€ 8		13018 6,35€ 20		13019 3,81€ 30
OE 915135E003		OE 915305T5003		OE 906875A50030	
	13020 2,03€ 15		13021 2,03€ 10		13022 2,54€ 6
OE 916205R2003		OE 38529689A6300		OE 906835A5003	
	13023 2,54€ 20		13024 4,57€ 20		13025 2,03€ 30
OE 90672671003		OE 915345E0000		OE 343555D2003	

PEUGEOT / CITROËN

52899	0,18	6	24	360	345 PCS
	Kg	sub	ff		
29,70€					















	13128 8,47€ 50		13129 3,39€ 20		13130 3,39€ 20
OE 947098		OE 856535		OE 69911WK	
	13131 3,39€ 20		13132 4,23€ 25		13133 5,93€ 35
		OE 694143		OE 743707	
	13134 5,08€ 30		13135 5,93€ 35		13136 2,54€ 15
OE 7703074022		OE 7703077059		OE 698317	
	13137 4,23€ 25		13138 5,08€ 30		13139 6,77€ 40
OE 699502		OE 6995X3		OE 69945	

TRUSĂ DE CLIPS DE PLASTIC

FIAT

52900	0,50	6	24	360	308 PCS
29,70€	Kg	sub	ff		















 13140 5,53€ OE 14591784	 13141 3,68€ OE 1459487	 13142 4,61€ OE 1300433650
 13143 1,47€ OE 71717421	 13144 4,61€ OE 82456515	 13145 4,61€ OE 5757139
 13146 1,47€ OE 14592387	 13147 4,61€ OE 46306526	 13148 4,61€ OE 14591687
 13149 4,61€ OE 14592387	 13150 5,53€ OE 83468473	 13151 9,21€ OE 7677865

VOLVO

52901	0,48	6	20	350 PCS
32,40€	Kg	sub	ff	



 13152 4,55€ OE 8099905N07	 13153 5,47€ OE 4292906	 13154 3,64€ OE 12681763
 13155 7,29€ OE 51131804205	 13156 7,29€ OE 947098	 13157 7,29€ OE 591740
 13158 4,55€ OE 6384801G00	 13159 3,64€ OE 9133417	 13160 7,29€ OE 9133073
 13161 5,47€ OE 3272075327462B	 13162 3,64€ OE 327462A	 13163 3,64€ OE 3923712

VOLSKWAGEN

52889	0,18	6	24	504	85 PCS
21,60€	Kg	sub	ff		



 13038 0,76€ OE 1H0868243B	 13039 3,81€ OE N90833801	 13040 3,05€ OE 3A0853575
 13041 1,91€ OE 4A0853825	 13042 5,72€ OE 6U085733	 13043 1,14€ OE 3B0853576
 13044 2,29€ OE 1H0819055B01C	 13045 1,91€ OE 443853909A	 13046 2,29€ OE 171885767
 13047 1,91€ OE N9020160H	 13048 3,81€ OE N0385501	 13049 3,81€ OE 191941142

FORD

52891	0,16	6	24	672	169 PCS
24,30€	Kg	sub	ff		



 13056 1,93€ OE 3885775	 13057 1,21€ OE N8019255	 13058 4,83€ OE N8062895
 13059 4,83€ OE N3798305	 13060 1,21€ OE 1007932	 13061 4,83€ OE 16500308
 13062 4,83€ OE N8031705	 13063 1,45€ OE W7067135300	 13064 4,83€ OE N3882465
 13065 3,62€ OE F22Z16774A	 13066 1,21€ OE 1673046	 13067 6,03€ OE F1CZ16674A

TRUSĂ DE CLIPS DE PLASTIC

NISSAN

52894	0,19	6	24	216	139 PCS
21,60€	Kg	5.6	11	11	



	13080 3,83€ OE 76906T300		13081 5,11€ OE 0155300172		13082 2,55€ OE 68425H5000
	13083 1,53€ OE 75521611000		13084 5,11€ OE 62869N4700		13085 1,28€ OE 6384401A00
	13086 1,28€ OE 7688257A00		13087 6,38€ OE 6684101G00		13088 2,55€ OE 1099830880
	13089 2,55€ OE 8942798070		13090 2,04€ OE 6384801G00		13091 1,28€ OE 6385401A00

AUDI

52890	0,16	6	24	504	31 PCS
21,60€	Kg	5.6	11	11	



	13050 1,91€ OE 3B0868243		13051 4,61€ OE 1H0867199A		13052 2,76€ OE 1H0868243B
	13053 9,21€ OE 357853575		13054 4,61€ OE 1H0853585A		13055 2,76€ OE 3A0853575

BMW

52892	0,16	6	24	672	31 PCS
21,60€	Kg	5.6	11	11	



	13068 8,02€ OE 51311802258		13069 9,62€ OE 51313804205		13070 3,21€ OE 51118174185
	13071 3,21€ OE 51481938725		13072 4,81€ OE 703867299		13073 1,60€ OE 51131960054

BENZ

52893	0,20	6	24	504	95 PCS
24,30€	Kg	5.6	11	11	









	13074 12,11€ OE A0019884481		13075 8,07€ OE A0019882981		13076 6,06€ OE A1249900492
	13077 1,61€ OE A0019888081		13078 2,42€ OE A1249880492		13079 8,07€ OE A0019880325

RENAULT

52897	0,43	6	24	360	300 PCS
35,10€	Kg	5.6	11	11	



	13116 11,43€ OE 7703077421		13117 11,43€ OE 7703077421		13118 13,71€ OE 7703081184
	13119 3,43€ OE 7703074022		13120 13,71€ OE 7703074022		13121 14,86€ OE 7703077059

TRUSĂ DE CLIPS DE PLASTIC

MITSUBISHI

52895	0,19	6	24	132 PCS
21,60€	Kg	sub	ff	









 13092 4,00€ OE 8942180270	 13093 8,00€ OE 9018905013	 13094 2,67€ OE MU480033
 13095 1,60€ OE 128100231	 13096 2,13€ OE MU480034	 13097 0,80€ OE MR138807
 13098 1,07€ OE MB253964	 13099 8,00€ OE HB121467	 13100 0,80€ OE MB271999
 13101 2,13€ OE MB696120	 13102 1,33€ OE MR200300	 13103 2,67€ OE MB846992

VAUXHALL / OPEL

52898	0,45	6	24	360	300 PCS
29,70€	Kg	sub	ff	tbl	



 13122 3,76€ OE 90218614	 13123 7,52€ OE 174864	 13124 10,28€ OE N0385501
 13125 9,41€ OE 2345959	 13126 9,41€ OE 2240582	 13127 7,52€ OE 180942

UNIVERSAL

52888	0,17	6	24	672	128 PCS
24,30€	Kg	sub	ff	tbl	



 13026 2,26€ OE 3885775	 13027 2,83€ GENERAL USE	 13028 1,70€ OE 6003423
 13029 1,70€ VW: N989022 Chrysler: 6003349 Ford: 385661	 13030 7,07€ GM: 20699808 Chrysler: 6502328	 13031 1,13€ Ford: N8043795
 13032 4,24€ Mazda: 6508197AA Ford: F22Z16774A	 13033 2,83€ GM: 16674629 Ford: N8061135	 13034 5,65€ Nissan: 0153301781
 13035 1,70€ GM: 10124502 BMW: 52201964201 Land Rover: DZM100080	 13036 1,70€ VW: N9020160H Ford: 6998849 BMW: 51471904317 Opel: 2207713	 13037 3,39€ GENERAL USE



15



ÎMBRĂCĂMINTE

VESTĂ	256
GEACĂ	256

VESTĂ JBM

N

MĂRIMEA M

70001	0,30	5	180
32,00€	Kg		

70007	0,30	5	180
32,00€	Kg		

MĂRIMEA L

70002	0,40	5	180
32,00€	Kg		

70008	0,40	5	180
32,00€	Kg		

MĂRIMEA XL

70003	0,40	5	180
32,00€	Kg		

70009	0,40	5	180
32,00€	Kg		



2 buzunare interioare cu capacitate mare



2 buzunare laterale



Rezistentă la frig



Termică



Ușoară



GEACĂ JBM

N

MĂRIMEA M

70004	0,60	5	120
38,00€	Kg		

70010	0,60	5	120
38,00€	Kg		

MĂRIMEA L

70005	0,70	5	120
38,00€	Kg		

70011	0,60	5	120
38,00€	Kg		

MĂRIMEA XL

70006	0,70	5	120
38,00€	Kg		

70012	0,70	5	120
38,00€	Kg		



Guler înalt și fermoar în față



3 buzunare exterioare



16



PRODUSE PROMOȚIONALE

EXPOZANȚII ȘI ACCESORII	258
PROMOȚIONALI	259

EXPOZITOR UNELTE ASORTATE

51652	140	1	1
1.950,00€	Kg	ft	ft

Conține:

- 1 expoziție JBM de 210cm x 124cm x 48cm
- 2 jocuri de 7 chei combinate scurte de la 20mm la 32mm
- 2 jocuri de 14 chei combinate scurte de la 6mm la 19mm
- 2 jocuri de 12 chei fixe de 6x7 la 30x32
- 2 jocuri de 7 chei fixe de 6x7 la 18x19
- 2 jocuri de 7 chei inelare cu cot
- 2 jocuri de 12 chei combinate cu clichet
- 2 jocuri de 8 chei combinate scurte de 10 la 19mm
- 2 clești cu clamă - 1un. în vid
- 2 patenturi de presiune - 1un în vid
- 2 jocuri de 12 chei cu 2 capete inelare cu cot
- 2 clești papagal - deschisă- 1un. în vid
- 2 clești papagal - închisa- 1 un. în vid
- 2 clești de siguranță interior - 1 un. în vid
- 2 clești de siguranță exterior - 1 un. în vid
- 2 clești vârf alungit 200mm - 1 un. în vid
- 2 clești scurt diagonal 175mm - 1 un. în vid
- 2 clești universal 200mm - 1 un. în vid
- 3 truse de 216 piese HEX.
- 3 truse de 113 piese de 12 fețe
- 3 truse de 108 piese Hex.



EXPOZITOR UNELTE GOL

51288	
388,00€	
Kg	52,85
ft	1
ft	8



RAFT INFERIOR + 2 ETAJERE

51289	
50,20€	
Kg	5,05
ft	6
ft	72

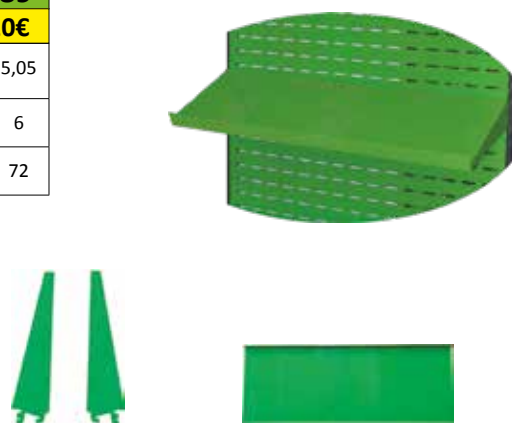

CÂRLIG CU VÂRF INCHIS

51315	
2,50€	
Kg	0,03
ft	20
ft	280

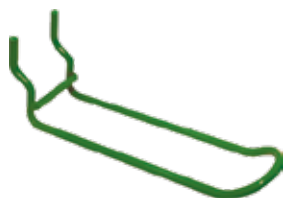

CÂRLIG CU UN CAPĂȚ

11318	
2,50€	
Kg	0,04
ft	20
ft	600



UMBRELE PROMOȚIONALE JBM

52857	0,31	10	60	600
5,80€	Kg	5x6	11	

84cm

TRICOU JBM

mărimea S

13242	0,31
12,50€	Kg

mărimea M

13243	0,31
12,50€	Kg

mărimea L

13244	0,31
12,50€	Kg

mărimea XL

13245	0,31
12,50€	Kg



50	600
11	

CORT STAND JBM 3x3m

52995	20	1
195,00€	Kg	11

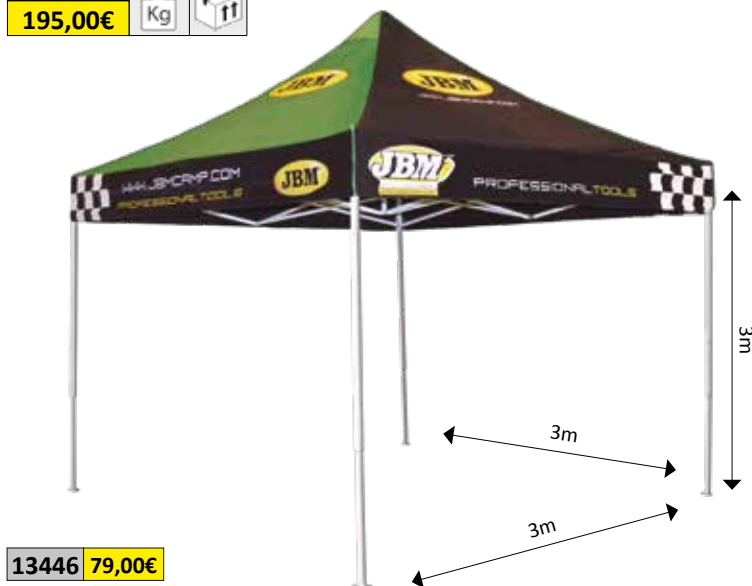

13446 79,00€

LATERAL
P/REF. 52995

PEN PROMOȚIONAL JBM

N

53345	
0,50€	
Kg	0,35
5x5	50
11	1.000
	36.000



RUCSAC JBM

N

13968	
3,00€	
Kg	0,30
5x5	50
11	800



TROTINETĂ CU 3 ROȚI TRISCOOTER

51833	5,13	4	40
44,00€	Kg	11	



GEANTĂ DE RĂCIT

50994	0,32	15	270
4,10€	Kg	11	

51688	0,31	50	300
4,10€	Kg	11	



CUPRINS

Cuprins referințelor de date

-  Greutatea articolului în kilograme
-  Numărul de articole / subcutie
-  Numărul de articole / expozitor
-  Numărul de articole / pachet
-  Numărul de articole / cutie
-  Numărul de pachete / cutie
-  Numărul de articole / paleta
-  Prezentat în blister
-  Produs nou

Cuprinsul aracteristicilor generale

-  Capacitate în funcție de volum
-  Magnetizat
-  Greutatea suportată de magnet
-  Greutatea care suportă articolul
-  Nivel de zgomot
-  Greutatea
-  Categorie ușoară
-  Zoom
-  Conexiune Bluetooth
-  Conexiune USB
-  Material de Aluminiu
-  Chrome

Cuprins de instrumente













-  Tubulară pătrată
-  Tubulară cu 12 margini
-  Tubulară cu 12 margini (2)
-  Tubulară hexagonală
-  Tubulară cu vîrf XZN
-  Tubulară twist
-  Tubulară spline
-  Vîrf slotted
-  Vîrf ribe
-  Vîrf Phillips (steluță)
-  Vîrf Pozidriv (steluță dublă)
-  Vîrf pătratic
-  Vîrf invariabil torx
-  Vîrf invariabil torx - XZN
-  Vîrf torx
-  Vîrf triunghiular
-  Vîrf T5 – 5 fețe
-  Vîrf cu 12 margini
-  Vîrf tensor
-  Allen
-  Cabota normală
-  Cabota rotundă



Cuprinsul produselor pneumatice

-  Revoluțiile pe minut (în general)
-  Revoluțiile pe minut (înainte)
-  Revoluțiile pe minut (inversa)
-  Newton-metro(Nm) / Kilogramos(Kg)
-  Kg/ inch pătrat
-  Unitatea de presiune (Bar)
-  Întrarea aerului
-  Ieșire din spate
-  Ieșire din spate de 360
-  Ieșire frontală
-  Ieșire frontală
-  Ieșire frontală
-  Vibrații scăzute
-  Dimensiunile de pistol
-  Mâner ergonomic
-  vibrație
-  Orbită de disc
-  Diametru de disc
-  Dimensiunile pe diagonală
-  Dimensiunile găurii
-  Mișcare la 360
-  Numărul de viteze
-  Cai putere
-  Mecanism dublu ciocan
-  Ultra puternică
-  Unghi de 90



CUPRINS

Cuprinsul produselor electronice



	Tip de Led: SMD
	Tip de Led: COB
	Tip de Led: Cree XP-E
	Cantitatea/ puterea Led
	Cantitatea de Leduri
	Distanță de iluminare
	3 intensități de iluminare
	Flux luminos
	Lumina împrăștiată
	Lumina concentrată
	Numărul de tipuri de bliț
	Putere V/Watts
	Durata bateriei
	Durata de încărcare
	Tip de bateria
	Numărul de baterii AAA
	Transformator/ priză de perete
	Încărcător cu USB
	Brichetă
	Baza înclinată
	Baza înclinată
	Umeraș
	Umeraș-rotativ
	Lungimea cablului

	Rezistent la lovitură
	Gradul de protecție
	Magnetizat



Cuprinsul produselor de utilaj

	Compresor de arcuri
	Dezasamblarea amortizorului



Cuprinsul produselor lubrifiante

	Capacitatea de volum
	Flux de aer

Cuprinsul accesoriilor

	Ajunge la 1,300
	2 tipuri de semnal de lumină

Cuprinsul certificatelor

	Certificat CE
	Normative în conformitate cu protecția mânușilor
	În conformitate cu Legea de Siguranță a produselor Germane (ProdSG)



INDEXUL NUMERIC

REF.	pag.	€
10000	189	145,00 €
10054	136	1,40 €
10055	136	2,10 €
10485	138	9,30 €
10486	138	9,30 €
10494	138	5,30 €
10495	138	2,20 €
10496	138	2,20 €
10497	138	2,20 €
10498	138	2,20 €
10499	138	2,20 €
10500	138	2,20 €
10501	138	8,30 €
10502	138	3,10 €
10639	194	10,90 €
10671	200	15,20 €
10676	59/60/61	16,90 €
10677	59/60/61	19,60 €
10678	59/60/61	16,90 €
10679	59/60/61	21,60 €
10680	59/60/61	20,70 €
10682	194	88,00 €
10683	194	4,00 €
10720	206	14,80 €
10721	206	19,00 €
10722	206	14,90 €
10723	206	14,40 €
10724	206	14,40 €
10726	59/60/61	22,80 €
10727	59/61	18,60 €
10728	59/60/61	37,90 €
10729	59/60/61	52,00 €
10730	59/60/61	44,50 €
10731	59	13,30 €
10732	59	16,60 €
10733	59	20,20 €
10735	59/61	17,20 €
10736	59	6,00 €
10750	79	13,00 €
10751	79	15,00 €
10761	206	16,00 €
10762	206	16,50 €
10766	79/85	2,80 €
10767	189	21,00 €
10768	194	112,00 €
10769	194	18,00 €
10770	194	6,00 €
10772	243	0,02 €
10773	243	0,05 €
10774	243	0,08 €
10775	243	0,12 €

REF.	pag.	€
10776	243	0,16 €
10777	243	0,19 €
10778	243	0,32 €
10779	241/243	0,01 €
10780	241/243	0,01 €
10781	241/243	0,02 €
10782	243	0,02 €
10783	243	0,04 €
10784	241/243	0,02 €
10785	241/243	0,05 €
10786	241/243	0,10 €
10787	243	0,01 €
10788	243	0,01 €
10789	243	0,01 €
10790	243	0,02 €
10791	243	0,03 €
10792	243	0,04 €
10793	240	0,14 €
10794	240	0,26 €
10795	240	0,42 €
10805	241	0,05 €
10812	241	0,20 €
10813	241	0,25 €
10823	245	0,09 €
10824	245	0,09 €
10825	245	0,09 €
10826	245	0,19 €
10827	245	0,23 €
10828	245	0,23 €
10829	245	0,09 €
10830	245	0,09 €
10831	245	0,09 €
10832	245	0,09 €
10833	245	0,09 €
10834	245	0,12 €
10835	245	0,12 €
10836	245	0,16 €
10837	245	0,16 €
10838	245	0,16 €
10839	245	0,19 €
10840	245	0,12 €
10868	248	0,15 €
10869	248	0,20 €
10870	248	0,25 €
10871	248	0,20 €
10872	248	0,35 €
10873	248	0,35 €
10874	248	0,20 €
10875	248	0,35 €
10876	248	0,35 €
10877	242	0,12 €

REF.	pag.	€
10878	242	0,15 €
10879	242	0,09 €
10880	242	0,11 €
10881	242	0,13 €
10882	240	0,11 €
10883	240	0,10 €
10884	240	0,11 €
10885	250	0,08 €
10886	250	0,08 €
10887	250	0,12 €
10888	250	0,16 €
10889	250	0,16 €
10890	250	0,19 €
10891	250	0,12 €
10892	250	0,12 €
10893	250	0,12 €
10894	250	0,08 €
10895	250	0,08 €
10896	250	0,12 €
10897	250	0,12 €
10898	250	0,12 €
10899	250	0,12 €
10900	250	0,12 €
10901	250	0,12 €
10902	250	0,19 €
10905	250	0,12 €
10906	250	0,12 €
10907	250	0,12 €
10908	250	0,12 €
10909	250	0,12 €
10910	250	0,12 €
10911	250	0,12 €
10912	250	0,12 €
10913	250	0,12 €
10914	250	0,13 €
10915	250	0,13 €
10916	250	0,13 €
10917	250	0,13 €
10918	250	0,13 €
10919	250	0,13 €
10920	250	0,13 €
10921	250	0,13 €
10923	86	1,10 €
10924	86	4,50 €
10925	189	18,00 €
10945	220	2,30 €
10953	139	12,00 €
10961	75	12,00 €
10964	214	5,30 €
10965	214	5,00 €
10966	214	9,80 €

REF.	pag.	€
10982	76	15,00 €
10993	201	95,80 €
11075	208	58,00 €
11076	208	92,60 €
11077	208	78,00 €
11078	208	313,10 €
11079	208	22,00 €
11080	208	98,00 €
11081	208	19,10 €
11082	208	9,00 €
11083	208	390,00 €
11084	208	66,70 €
11085	208	198,00 €
11086	208	18,00 €
11087	200	16,00 €
11088	200	28,90 €
11092	75	38,00 €
11093	75	4,00 €
11095	206	19,10 €
11096	206	22,70 €
11097	206	33,40 €
11098	206	40,50 €
11100	207	16,00 €
11101	207	68,00 €
11102	207	6,60 €
11103	79	5,00 €
11106	126	3,00 €
11107	75	4,00 €
11118	61	4,50 €
11121	108	2,30 €
11122	108	3,10 €
11123	108	3,60 €
11124	108	4,30 €
11125	108	4,80 €
11126	108	6,80 €
11127	108	7,60 €
11128	108	8,10 €
11129	108	8,20 €
11130	108	8,20 €
11131	108	8,30 €
11132	108	8,30 €
11133	108	8,80 €
11134	108	9,20 €
11135	108	9,70 €
11136	108	9,80 €
11137	108	11,00 €
11138	108	11,20 €
11139	108	11,30 €
11140	108	11,80 €
11141	108	12,70 €
11142	108	13,00 €

REF.	pag.	€
11143	108	15,60 €
11144	108	20,00 €
11145	108	21,20 €
11146	108	23,60 €
11147	108	26,80 €
11148	108	28,30 €
11149	108	31,80 €
11150	108	33,80 €
11151	108	40,30 €
11152	108	44,00 €
11153	108	14,00 €
11154	108	14,70 €
11155	108	15,00 €
11156	108	16,90 €
11157	108	17,00 €
11158	108	17,50 €
11159	108	18,60 €
11160	108	18,70 €
11161	108	19,00 €
11162	108	19,30 €
11163	108	19,50 €
11164	108	20,40 €
11165	108	20,50 €
11166	108	22,20 €
11167	108	25,60 €
11168	108	26,00 €
11169	108	26,50 €
11170	108	27,00 €
11171	108	30,30 €
11172	108	31,80 €
11173	108	32,00 €
11174	108	32,30 €
11175	108	33,00 €
11176	108	34,80 €
11177	108	37,30 €
11178	108	37,80 €
11179	108	41,40 €
11180	108	44,50 €
11181	108	44,80 €
11182	108	48,00 €
11183	108	50,00 €
11184	108	60,00 €
11185	108	62,00 €
11186	108	63,00 €
11187	108	68,30 €
11188	108	69,50 €
11189	108	79,50 €
11190	108	96,50 €
11191	108	96,80 €
11192	108	106,00 €
11193	108	114,00 €
11194	108	123,30 €
11195	108	2,00 €

REF.	pag.	€
11205	62	1,80 €
11206	62	1,80 €
11207	62	2,50 €
11208	62	3,10 €
11209	62	4,80 €
11210	62	4,80 €
11211	62	6,90 €
11212	39	4,30 €
11213	39	9,20 €
11214	39	11,00 €
11219	211	551,30 €
11313	62/63	42,00 €
11314	104	6,40 €
11315	104	6,60 €
11316	104	6,90 €
11318	258	2,50 €
11320	188	12,56 €
11321	188	18,23 €
11323	198	16,00 €
11324	79	17,50 €
11325	79	17,50 €
11329	211	362,90 €
11374	124	4,60 €
11375	124	4,60 €
11376	124	4,60 €
11377	124	4,60 €
11378	124	4,60 €
11379	124	4,60 €
11380	124	4,60 €
11381	124	4,60 €
11382	124	4,60 €
11383	124	4,60 €
11384	124	4,60 €
11385	124	4,60 €
11386	124	4,60 €
11387	124	4,60 €
11388	124	4,60 €
11389	124	4,60 €
11390	124	4,60 €
11391	124	4,60 €
11392	124	4,60 €
11393	124	4,60 €
11394	124	4,60 €
11492	140	36,50 €
11493	140	39,00 €
11494	140	42,30 €
11541	112	5,40 €
11542	112	5,40 €
11543	112	5,40 €
11544	112	5,00 €
11545	112	5,00 €
11546	112	5,00 €
11547	112	5,00 €

REF.	pag.	€
11613	108	6,70 €
11614	108	8,20 €
11615	108	8,80 €
11616	108	11,00 €
11617	108	11,50 €
11618	108	12,00 €
11619	108	12,50 €
11621	108	222,00 €
11622	108	280,00 €
11623	108	303,00 €
11624	108	120,00 €
11625	108	192,00 €
11628	104	7,20 €
11867	191	9,00 €
11877	75	70,00 €
11878	156	3,00 €
11879	156	3,00 €
11880	156	5,00 €
11890	236	0,54 €
11891	236	0,42 €
11892	200	9,90 €
11893	132	6,40 €
11894	132	7,00 €
11895	132	7,60 €
11896	132	8,80 €
11900	235	2,80 €
11901	235	1,60 €
11902	235	1,60 €
11903	235	5,00 €
11904	235	1,60 €
11905	235	1,40 €
11906	235	6,00 €
11907	235	11,00 €
11930	208	292,00 €
11936	126	4,00 €
11937	126	5,00 €
11938	107	42,00 €
11939	194	48,00 €
11940	195	37,50 €
11945	45	5,30 €
11946	45	2,90 €
11947	45	5,50 €
11950	201	18,00 €
11956	94	4,10 €
11957	94	4,10 €
11959	118	2,90 €
11960	235	1,50 €
11962	107	6,00 €
11963	107	7,00 €
11964	107	9,00 €
11965	107	12,00 €
11966	107	14,00 €
11967	107	14,00 €

REF.	pag.	€
11974	207	1,20 €
11975	207	1,20 €
11976	207	1,20 €
11977	207	1,20 €
11978	207	1,20 €
11979	207	1,20 €
11980	207	1,20 €
11981	207	1,20 €
11982	207	1,20 €
11983	207	1,20 €
11989	75	4,00 €
11990	107	15,00 €
11992	211	60,00 €
11993	58	73,40 €
11994	58	30,70 €
11995	58	51,00 €
11996	58	48,00 €
11997	58	45,60 €
11998	58	68,70 €
11999	58	19,70 €
12000	58	18,60 €
12001	58	19,40 €
12002	58	26,30 €
12003	58	40,70 €
12004	58	19,30 €
12005	58	28,60 €
12006	58	25,70 €
12007	58	27,20 €
12009	96	7,50 €
12022	201	33,70 €
12029	28	3,00 €
12030	28	5,50 €
12032	198	7,50 €
12044	190	134,90 €
12046	196	274,00 €
12055	215	13,00 €
12056	189	44,50 €
12060	40	1,60 €
12061	108	5,10 €
12062	108	5,30 €
12063	108	5,40 €
12064	108	5,50 €
12065	108	5,80 €
12066	104/108	5,90 €
12067	108	6,00 €
12068	104/108	6,10 €
12069	104/108	6,20 €
12070	108	6,20 €
12071	108	6,30 €
12072	108	7,20 €
12074	106	6,60 €
12075	106	9,70 €
12901	130	5,20 €

REF.	pag.	€
12902	231	5,70 €
12903	231	5,70 €
12904	231	5,70 €
12905	231	5,70 €
12906	231	5,70 €
12907	231	5,70 €
12908	231	5,70 €
12909	231	5,70 €
12910	231	5,70 €
12911	231	5,70 €
12912	231	5,70 €
12913	231	5,70 €
12914	231	9,80 €
12915	231	15,50 €
12916	231	6,50 €
12917	231	9,80 €
12918	231	9,80 €
12919	231	9,80 €
12920	231	9,80 €
12921	231	9,80 €
12922	231	9,80 €
12923	231	9,80 €
12924	231	5,70 €
12925	231	9,80 €
12926	143	17,50 €
12927	143	18,40 €
12928	143	19,30 €
12929	143	20,50 €
12930	143	22,10 €
12937	106	5,60 €
12939	106	5,70 €
12940	106	5,70 €
12941	106	5,70 €
12942	106	5,70 €
12943	106	5,80 €
12944	106	6,00 €
12945	106	6,10 €
12948	231	22,28 €
12949	231	22,28 €
12954	250	0,13 €
12955	112	27,80 €
12956	112	27,80 €
12957	112	27,80 €
12958	112	27,80 €
12959	112	27,80 €
12960	112	27,80 €
12961	112	27,80 €
12962	94	2,50 €
12964	50	1,50 €
12965	50	1,80 €
12973	233	0,58 €
12974	123	21,00 €
12975	123	23,00 €

REF.	pag.	€
12977	151	38,00 €
12985	62	10,10 €
12987	95	1,20 €
12988	100	7,00 €
13001	208	103,00 €
13002	251	2,95 €
13003	251	1,47 €
13004	251	3,68 €
13005	251	3,68 €
13006	251	1,84 €
13007	251	3,68 €
13008	251	2,95 €
13009	251	1,47 €
13010	251	2,95 €
13011	251	1,84 €
13012	251	2,95 €
13013	251	2,95 €
13014	251	3,05 €
13015	251	1,27 €
13016	251	1,52 €
13017	251	6,35 €
13018	251	6,35 €
13019	251	3,81 €
13020	251	2,03 €
13021	251	2,03 €
13022	251	2,54 €
13023	251	2,54 €
13024	251	4,57 €
13025	251	2,03 €
13026	254	2,26 €
13027	254	2,83 €
13028	254	1,70 €
13029	254	1,70 €
13030	254	7,07 €
13031	254	1,13 €
13032	254	4,24 €
13033	254	2,83 €
13034	254	5,65 €
13035	254	1,70 €
13036	254	1,70 €
13037	254	3,39 €
13038	252	0,76 €
13039	252	3,81 €
13040	252	3,05 €
13041	252	1,91 €
13042	252	5,72 €
13043	252	1,14 €
13044	252	2,29 €
13045	252	1,91 €
13046	252	2,29 €
13047	252	1,91 €
13048	252	3,81 €
13049	252	3,81 €

REF.	pag.	€
13050	253	1,91 €
13051	253	4,61 €
13052	253	2,76 €
13053	253	9,21 €
13054	253	4,61 €
13055	253	2,76 €
13056	252	1,93 €
13057	252	1,21 €
13058	252	4,83 €
13059	252	4,83 €
13060	252	1,21 €
13061	252	4,83 €
13062	252	4,83 €
13063	252	1,45 €
13064	252	4,83 €
13065	252	3,62 €
13066	252	1,21 €
13067	252	6,03 €
13068	253	8,02 €
13069	253	9,62 €
13070	253	3,21 €
13071	253	3,21 €
13072	253	4,81 €
13073	253	1,60 €
13074	253	12,11 €
13075	253	8,07 €
13076	253	6,06 €
13077	253	1,61 €
13078	253	2,42 €
13079	253	8,07 €
13080	253	3,83 €
13081	253	5,11 €
13082	253	2,55 €
13083	253	1,53 €
13084	253	5,11 €
13085	253	1,28 €
13086	253	1,28 €
13087	253	6,38 €
13088	253	2,55 €
13089	253	2,55 €
13090	253	2,04 €
13091	253	1,28 €
13092	254	4,00 €
13093	254	8,00 €
13094	254	2,67 €
13095	254	1,60 €
13096	254	2,13 €
13097	254	0,80 €
13098	254	1,07 €
13099	254	8,00 €
13100	254	0,80 €
13101	254	2,13 €
13102	254	1,33 €

REF.	pag.	€
13103	254	2,67 €
13104	251	1,85 €
13105	251	3,48 €
13106	251	1,85 €
13107	251	1,85 €
13108	251	4,63 €
13109	251	6,95 €
13110	251	3,48 €
13111	251	2,32 €
13112	251	1,39 €
13113	251	4,63 €
13114	251	4,63 €
13115	251	6,95 €
13116	253	11,43 €
13117	253	11,43 €
13118	253	13,71 €
13119	253	3,43 €
13120	253	13,71 €
13121	253	14,86 €
13122	254	3,76 €
13123	254	7,52 €
13124	254	10,28 €
13125	254	9,41 €
13126	254	9,41 €
13127	254	7,52 €
13128	251	8,47 €
13129	251	3,39 €
13130	251	3,39 €
13131	251	3,39 €
13132	251	4,23 €
13133	251	5,93 €
13134	251	5,08 €
13135	251	5,93 €
13136	251	2,54 €
13137	251	4,23 €
13138	251	5,08 €
13139	251	6,77 €
13140	252	5,53 €
13141	252	3,68 €
13142	252	4,61 €
13143	252	1,47 €
13144	252	4,61 €
13145	252	4,61 €
13146	252	1,47 €
13147	252	4,61 €
13148	252	4,61 €
13149	252	4,61 €
13150	252	5,53 €
13151	252	9,21 €
13152	252	4,55 €
13153	252	5,47 €
13154	252	3,64 €
13155	252	7,29 €

REF.	pag.	€
13156	252	7,29 €
13157	252	7,29 €
13158	252	4,55 €
13159	252	3,64 €
13160	252	7,29 €
13161	252	5,47 €
13162	252	3,64 €
13163	252	3,64 €
13234	190	169,10 €
13242	259	12,50 €
13243	259	12,50 €
13244	259	12,50 €
13245	259	12,50 €
13446	259	79,00 €
13499	96	7,70 €
13500	96	7,70 €
13670	58	12,65 €
13674	42	0,30 €
13675	42	0,30 €
13676	42	0,35 €
13677	42	0,30 €
13678	42	0,30 €
13679	140	5,75 €
13680	106	12,00 €
13681	106	12,00 €
13682	106	12,00 €
13683	106	12,00 €
13684	106	12,50 €
13685	106	12,50 €
13686	106	12,50 €
13687	106	13,50 €
13688	106	13,50 €
13689	106	13,50 €
13704	147	16,00 €
13705	197	445,00 €
13707	54	8,10 €
13708	54	8,00 €
13709	54	8,00 €
13710	54	8,90 €
13712	54	9,30 €
13723	108	10,50 €
13724	108	10,90 €
13725	108	11,00 €
13726	108	11,20 €
13727	108	11,40 €
13728	108	11,60 €
13729	108	12,60 €
13730	108	12,70 €
13731	108	12,90 €
13732	108	13,70 €
13733	108	14,40 €
13734	108	14,90 €
13735	108	15,00 €

REF.	pag.	€
13736	108	15,30 €
13738	235	3,00 €
13739	235	4,60 €
13740	236	4,50 €
13741	234	21,00 €
13745	108	15,50 €
13746	108	15,70 €
13747	108	15,90 €
13748	108	16,30 €
13803	215	7,05 €
13805	233	9,80 €
13806	233	9,80 €
13809	100	8,75 €
13810	100	10,30 €
13813	114	4,70 €
13814	114	7,00 €
13816	73/208	0,60 €
13817	94	14,05 €
13818	94	16,90 €
13819	244	5,20 €
13820	244	5,50 €
13821	244	11,35 €
13822	244	8,95 €
13823	244	4,45 €
13824	244	6,50 €
13825	244	8,60 €
13826	244	10,70 €
13827	244	12,75 €
13828	244	9,25 €
13829	244	7,90 €
13830	244	8,95 €
13831	244	10,30 €
13832	244	10,66 €
13833	244	7,20 €
13842	112	4,60 €
13843	112	3,30 €
13844	112	6,60 €
13845	112	4,80 €
13853	194	93,00 €
13855	224	6,20 €
13856	125	7,80 €
13884	58	9,00 €
13930	100	0,95 €
13931	100	1,70 €
13932	100	1,10 €
13933	100	1,30 €
13934	100	1,40 €
13935	100	1,40 €
13936	100	3,10 €
13937	100	3,20 €
13938	100	3,10 €
13939	100	3,20 €
13940	62	14,20 €

REF.	pag.	€
13941	62	18,30 €
13942	62	30,50 €
13943	62	29,50 €
13944	62	19,50 €
13968	259	3,00 €
14004	106	7,50 €
14005	106	7,50 €
14006	106	7,50 €
14007	106	7,50 €
14008	106	7,60 €
14009	106	7,60 €
14010	106	7,90 €
14011	106	8,20 €
14013	95	0,60 €
14014	188	4,10 €
14015	188	4,40 €
14016	188	4,90 €
50400	119	138,00 €
50403	119	84,00 €
50409	119	24,00 €
50410	119	138,00 €
50431	84	2,98 €
50437	9	64,00 €
50508	29	2,80 €
50517	213	68,00 €
50518	213	89,00 €
50521	8	69,00 €
50523	84	4,30 €
50524	84	4,30 €
50525	224	0,88 €
50526	224	3,60 €
50551	84	250,00 €
50560	35	30,00 €
50561	36	11,90 €
50562	36	16,50 €
50563	36	22,00 €
50564	36	18,00 €
50566	12	32,00 €
50567	53	9,60 €
50571	38	5,80 €
50577	115	9,00 €
50580	53	9,60 €
50585	227	9,80 €
50600	229	0,66 €
50601	229	0,20 €
50622	34	43,00 €
50623	19	49,00 €
50630	201	370,00 €
50631	198	60,00 €
50632	207	210,00 €
50644	223	11,60 €
50651	247	18,00 €
50652	247	18,00 €

REF.	pag.	€
50654	222	3,45 €
50656	214	198,00 €
50717	223	21,00 €
50724	148	22,00 €
50731	211	98,00 €
50751	191	29,40 €
50754	34	59,00 €
50760	229	0,09 €
50761	229	0,12 €
50762	229	0,20 €
50763	229	0,25 €
50764	229	0,31 €
50765	229	0,36 €
50766	229	0,43 €
50767	229	0,51 €
50768	229	0,54 €
50769	229	0,09 €
50770	229	0,13 €
50771	229	0,19 €
50772	229	0,25 €
50773	229	0,30 €
50774	229	0,39 €
50775	229	0,44 €
50776	229	0,46 €
50777	229	0,53 €
50778	229	0,09 €
50779	229	0,12 €
50780	229	0,19 €
50781	229	0,25 €
50782	229	0,30 €
50783	229	0,36 €
50784	229	0,44 €
50785	229	0,51 €
50786	229	0,59 €
50787	159	4,60 €
50788	159	9,80 €
50789	159	15,80 €
50790	159	22,00 €
50791	7	74,00 €
50792	49	108,00 €
50793	49	64,00 €
50797	191	425,60 €
50807	247	32,00 €
50808	70	48,00 €
50811	211	118,60 €
50812	197	290,00 €
50813	197	399,00 €
50814	197	680,00 €
50815	194	48,00 €
50816	195	59,00 €
50817	194	164,00 €
50818	194	156,00 €
50819	196	17,90 €

REF.	pag.	€
50820	196	22,00 €
50821	196	31,30 €
50822	196	41,70 €
50823	196	67,10 €
50824	196	64,40 €
50825	196	101,30 €
50827	153	244,00 €
50830	196	399,00 €
50831	198	295,00 €
50832	197	33,00 €
50833	197	78,00 €
50835	198	272,00 €
50836	199	98,00 €
50838	199	195,00 €
50839	201	195,00 €
50840	199	114,00 €
50843	70	54,00 €
50844	70	42,00 €
50852	191	22,00 €
50889	36	59,00 €
50895	6	132,00 €
50896	35	45,00 €
50901	114	17,00 €
50902	48	9,00 €
50903	114	23,80 €
50904	237	158,00 €
50905	237	156,00 €
50910	83	39,00 €
50911	200	740,00 €
50913	214	96,00 €
50915	84	3,80 €
50916	119	1,10 €
50917	189	253,70 €
50918	189	265,70 €
50923	201	184,00 €
50924	188	250,70 €
50935	189	495,00 €
50937	148	9,40 €
50938	230	144,00 €
50942	211	24,00 €
50957	216	17,50 €
50958	216	29,90 €
50959	216/243	12,40 €
50960	216	15,30 €
50961	216	81,90 €
50966	222	3,10 €
50980	28	25,00 €
50982	28	19,00 €
50983	22	38,00 €
50985	22	49,00 €
50994	259	4,10 €
51017	52	4,80 €
51018	52	4,80 €

REF.	pag.	€
51020	52	4,80 €
51021	52	4,80 €
51028	107	192,00 €
51033	209	56,00 €
51035	65	530,00 €
51050	216	216,50 €
51051	216	26,00 €
51055	229	0,64 €
51056	229	0,64 €
51058	189	497,00 €
51059	122	132,50 €
51118	208	2.980,00 €
51119	130	56,40 €
51120	154	38,00 €
51121	153	34,00 €
51122	140	141,00 €
51123	139	127,00 €
51124	140	161,90 €
51125	140	68,00 €
51126	142	27,00 €
51127	146	42,00 €
51131	112	47,70 €
51132	192	19,00 €
51135	185	63,70 €
51138	144	162,50 €
51139	138	166,30 €
51140	144	62,70 €
51206	88	230,00 €
51207	88	260,00 €
51210	90	647,00 €
51211	90	574,00 €
51212	89	520,00 €
51213	90	658,00 €
51214	91	145,00 €
51215	91	122,30 €
51216	97	520,00 €
51218	93	238,00 €
51219	95	195,00 €
51220	93	195,00 €
51221	93	181,90 €
51222	88	112,00 €
51225	91	189,90 €
51226	95	195,00 €
51227	95	169,20 €
51230	75	95,10 €
51231	144	162,50 €
51232	75	62,20 €
51235	204	42,00 €
51238	203	88,00 €
51239	203	118,00 €
51245	93	95,80 €
51246	223	6,40 €
51253	189	35,40 €

REF.	pag.	€
51258	86	0,15 €
51259	138	48,00 €
51260	21	34,00 €
51261	20	34,00 €
51262	146	40,00 €
51266	223	27,60 €
51270	44	14,00 €
51272	47	6,80 €
51277	99	39,00 €
51283	122	64,00 €
51285	43	11,00 €
51286	43	11,00 €
51287	43	13,00 €
51288	258	388,00 €
51289	258	50,20 €
51299	101	98,00 €
51305	44	16,00 €
51306	44	14,00 €
51307	45	29,70 €
51315	258	2,50 €
51316	10	66,00 €
51318	33	99,00 €
51323	200	49,00 €
51325	86	2,70 €
51326	86	5,30 €
51331	86	0,38 €
51332	124	109,10 €
51333	29	14,00 €
51336	104	26,00 €
51337	127	68,00 €
51338	146	41,00 €
51339	150	258,00 €
51340	183	35,60 €
51341	96/159	29,80 €
51347	156	9,00 €
51348	183	34,20 €
51349	144	27,50 €
51351	154	112,50 €
51352	125	7,20 €
51353	125	8,90 €
51354	125	10,60 €
51355	55/229	14,90 €
51356	191	38,00 €
51358	233	7,50 €
51359	233	8,00 €
51360	113	5,60 €
51361	113	9,80 €
51362	233	3,00 €
51363	203	68,00 €
51364	144	84,00 €
51365	203	78,00 €
51368	137	42,20 €
51369	137	36,00 €

REF.	pag.	€
51378	49	16,30 €
51380	49	16,30 €
51381	49	12,00 €
51382	44	12,00 €
51383	99	8,60 €
51384	21	34,00 €
51385	95	3,80 €
51386	96	5,40 €
51387	95	2,50 €
51388	97	18,00 €
51389	97	18,00 €
51390	97	18,00 €
51391	97	18,00 €
51392	97	25,00 €
51393	97	25,00 €
51394	97	25,00 €
51398N	218	0,99 €
51400	127	13,20 €
51401	127	15,30 €
51402	127	15,90 €
51403	127	12,90 €
51405	44	20,30 €
51406	44	29,20 €
51409	21	34,00 €
51410	21	34,00 €
51412	226	1,50 €
51414	137	12,00 €
51416	234	8,90 €
51418	65	2,30 €
51419	65	2,90 €
51420	65	2,90 €
51421	65	3,20 €
51422	65	3,60 €
51423	65	3,80 €
51425	64	530,00 €
51426	64	440,00 €
51427	63	890,00 €
51428	66	1.050,00 €
51430	62	108,90 €
51431	62	12,30 €
51432	62	40,30 €
51435	62	90,60 €
51436	62	33,40 €
51439	97	25,00 €
51440	97	25,00 €
51441	97	25,00 €
51442	97	25,00 €
51443	96	5,00 €
51444	96	5,00 €
51445	96	5,00 €
51446	86	2,60 €
51447	46	12,00 €
51448	46	48,20 €

REF.	pag.	€
51452	199	31,00 €
51456	63	495,00 €
51479	46	25,50 €
51482	184	58,00 €
51483	184	238,00 €
51485	184	49,00 €
51486	184	107,40 €
51487	185	250,00 €
51488	184	19,00 €
51489	183	19,10 €
51490	140	28,00 €
51491	130	143,00 €
51493	130	84,00 €
51494	128	96,30 €
51495	135	47,50 €
51496	136	8,00 €
51498	128	118,00 €
51499	128	139,00 €
51500	138	39,00 €
51501	139	39,00 €
51504	39	5,30 €
51525	46	6,80 €
51526	46	6,80 €
51528	37	29,00 €
51529	36	44,00 €
51538	245	0,10 €
51539	245	0,12 €
51540	245	0,14 €
51541	245	0,12 €
51542	245	0,14 €
51543	245	0,18 €
51544	245	0,26 €
51545	245	0,31 €
51546	245	0,19 €
51548	237	315,00 €
51549	237	315,00 €
51550	237	344,00 €
51551	237	252,00 €
51554	245	0,28 €
51555	237	154,00 €
51556	237	154,00 €
51557	237	154,00 €
51558	237	154,00 €
51570	69	135,00 €
51572	69	278,00 €
51573	86	2,00 €
51574	67	29,00 €
51575	67	184,00 €
51576	64	88,00 €
51583	237	166,00 €
51599	67	79,00 €
51600	67	66,00 €
51602	209	220,00 €

REF.	pag.	€
51603	209	280,00 €
51604	229	0,64 €
51610	15	158,00 €
51611	49	9,00 €
51612	84	5,80 €
51613	84	2,40 €
51614	84	2,98 €
51615	84	5,80 €
51616	19	398,00 €
51617	20	55,00 €
51622	120	12,20 €
51624	120	140,00 €
51627	120	122,00 €
51632N	218	0,99 €
51633	218	0,99 €
51634	218	0,99 €
51636N	218	1,18 €
51638N	218	1,18 €
51640N	218	1,18 €
51642N	218	1,18 €
51652	258	1.950,00 €
51653	65	6,90 €
51654	65	3,60 €
51655	65	3,70 €
51656	65	3,80 €
51657	65	7,90 €
51658	65	3,60 €
51659	35	56,00 €
51661	46/234	8,90 €
51674	39	5,80 €
51675	40	6,00 €
51680	220	2,40 €
51682	220	1,90 €
51684	220	1,90 €
51685	220	1,90 €
51688	259	4,10 €
51691	220	2,40 €
51692	220	2,00 €
51693	220	2,00 €
51694	220	2,00 €
51695	220	1,90 €
51696	220	2,00 €
51697	224	0,38 €
51703	235	7,50 €
51705	235	5,70 €
51706	237	18,00 €
51707	237	10,50 €
51708	237	14,00 €
51709	237	16,46 €
51710	237	20,62 €
51711	237	24,08 €
51712	237	12,00 €
51713	237	14,78 €

REF.	pag.	€
51714	237	19,69 €
51715	237	23,17 €
51716	237	27,86 €
51717	237	13,99 €
51718	237	16,90 €
51719	237	22,93 €
51720	237	25,76 €
51721	237	29,07 €
51722	237	16,31 €
51723	237	19,68 €
51724	237	24,69 €
51725	237	31,94 €
51726	237	32,21 €
51727	237	39,80 €
51737	66	426,00 €
51738	66	495,00 €
51741	232	0,32 €
51742	232	0,39 €
51743	232	0,51 €
51745	218	0,48 €
51746	28	9,00 €
51747	37	21,00 €
51750	200	220,00 €
51751	200	59,00 €
51785	218	0,52 €
51794	38	4,50 €
51795	38	6,80 €
51796	38	8,90 €
51797	38	12,00 €
51798	38	25,40 €
51799	245	0,19 €
51801	45	57,00 €
51802	29	14,50 €
51804	243	47,00 €
51805	46	15,00 €
51812	51	29,00 €
51814	224	7,99 €
51816	204	49,00 €
51817	222	3,72 €
51818	17	78,00 €
51819	11	56,00 €
51820	11	59,00 €
51822	152	109,00 €
51824	119	29,00 €
51828	146	444,00 €
51829	146	390,30 €
51830	146	76,50 €
51831	205	14,00 €
51832	114	19,50 €
51833	259	44,00 €
51837	206	175,10 €
51838	206	598,00 €
51839	212	28,00 €

REF.	pag.	€
51840	34	295,00 €
51841	183	69,50 €
51842	204	6,90 €
51843	245	0,19 €
51853	41	13,90 €
51855	19	398,00 €
51858	225	9,90 €
51859	205	3,80 €
51861	97/235	148,00 €
51863	226	53,00 €
51864	37	64,00 €
51876	192	19,00 €
51877	29	2,80 €
51878	37	41,10 €
51879	37	31,40 €
51885	24	76,00 €
51886	83	42,00 €
51887	49	2,50 €
51889	73	35,00 €
51890	24	89,00 €
51892	12	32,00 €
51893	133	398,00 €
51894	133	398,00 €
51895	195	58,00 €
51896	132	110,00 €
51897	132	168,60 €
51898	132	112,80 €
51899	132	131,00 €
51901	197	495,00 €
51902	139	59,00 €
51903	195	126,60 €
51905	196	20,90 €
51906	196	26,40 €
51907	196	33,40 €
51908	230	36,00 €
51909	49	2,50 €
51918	39	9,50 €
51919	149	58,00 €
51920	212	18,00 €
51921	44	18,00 €
51923	125	18,00 €
51925	224	0,98 €
51927	128	56,00 €
51928	191	12,00 €
51929	83	25,00 €
51930	20	42,00 €
51934	125	16,00 €
51935	223	142,00 €
51936	223	142,00 €
51937	223	142,00 €
51939	178	416,00 €
51940	165	399,00 €
51941	174	148,00 €

REF.	pag.	€
51942	172	359,00 €
51943	171	385,00 €
51944	182	358,00 €
51951	41	15,60 €
51952	47	9,90 €
51953	47	9,90 €
51954	38	24,40 €
51955	47	3,60 €
51958	148	340,00 €
51959	38	26,10 €
51960	78	27,00 €
51961	78	28,00 €
51962	77	21,00 €
51963	77	24,70 €
51964	77	24,50 €
51965	77	24,50 €
51966	78	18,00 €
51967	79	16,00 €
51968	79	16,00 €
51969	79	14,00 €
51970	24	9,90 €
51972	50	10,80 €
51973	226	42,00 €
51974	64	1,40 €
51975	64	1,40 €
51976	64	2,20 €
51977	64	2,50 €
51978	120	56,00 €
51980	98	12,40 €
51981	98	18,00 €
51982	213	105,00 €
51983	213	172,00 €
51984	213	210,00 €
51985	119	72,00 €
51986	212	9,80 €
51989	155	40,50 €
51990	145	85,90 €
51991	139	34,00 €
51995	54	19,50 €
51996	145	18,00 €
51997	136	44,20 €
51998	135	80,80 €
51999	145	75,60 €
52002	74	26,00 €
52008	127	36,00 €
52009	31	32,50 €
52010	141	48,40 €
52012	148	61,20 €
52013	40	9,50 €
52014	41	12,00 €
52016	132	2,10 €
52017	132	2,40 €
52018	132	2,60 €

REF.	pag.	€
52019	132	3,20 €
52021	132	3,40 €
52022	132	4,50 €
52023	132	6,60 €
52024	132	10,60 €
52025	132	13,00 €
52026	114	24,00 €
52027	239	14,00 €
52028	241	9,50 €
52029	241	14,00 €
52030	245	68,00 €
52031	244	34,00 €
52032	244	22,00 €
52033	248	32,00 €
52043	242	17,00 €
52044	240	22,00 €
52047	84	5,80 €
52048	84	5,38 €
52049	40	9,60 €
52050	54	86,00 €
52052	53	39,00 €
52053	250	29,00 €
52054	250	19,00 €
52055	199	108,00 €
52056	149	56,90 €
52057	119	4,40 €
52058	119	5,90 €
52059	28	32,00 €
52060	28	32,00 €
52065	119	32,00 €
52066	158	15,00 €
52068	47	3,50 €
52069	203	16,00 €
52070	203	24,00 €
52071	203	29,00 €
52072	47	5,00 €
52073	38	15,00 €
52074	38	15,00 €
52076	132	175,40 €
52077	113	57,70 €
52148	70	54,00 €
52149	213	225,00 €
52152	50	10,10 €
52153	135	67,00 €
52156	91	109,30 €
52157	94	34,00 €
52158	243	34,00 €
52159	92	48,00 €
52160	93	38,00 €
52162	213	39,90 €
52163	245	58,00 €
52165	92	84,00 €
52166	94	63,50 €

REF.	pag.	€
52167	91	37,50 €
52168	92	36,00 €
52169	48	19,00 €
52170	48	14,00 €
52171	94	26,00 €
52172	61	378,00 €
52180	39	16,10 €
52181	39	18,20 €
52182	39	18,60 €
52183	39	26,20 €
52184	39	39,50 €
52185	39	55,40 €
52186	39	68,00 €
52188	40	10,80 €
52189	137	92,00 €
52190	138	8,00 €
52191	123	340,00 €
52192	206	158,00 €
52193	206	310,00 €
52194	206	990,00 €
52195	208	110,00 €
52196	208	128,00 €
52197	45	41,50 €
52198	26	29,00 €
52200	215	64,00 €
52201	215	54,00 €
52202	215	60,00 €
52207	44	15,00 €
52227	153	248,00 €
52230	214	265,00 €
52231	212	39,60 €
52232	76	98,00 €
52233	204	348,00 €
52235	55	9,30 €
52236	55	10,60 €
52237	55	14,10 €
52238	55	21,20 €
52241	197	754,00 €
52242	192	8,60 €
52243	192	6,00 €
52244	120	58,00 €
52250	146	480,00 €
52254	76	48,30 €
52255	76	39,40 €
52259	224	3,00 €
52262	117	6,20 €
52263	117	11,50 €
52264	117	17,40 €
52265	117	20,00 €
52267	117	28,00 €
52268	117	11,00 €
52269	126	7,00 €
52270	142	99,90 €

REF.	pag.	€
52271	185	19,00 €
52272	51	22,80 €
52273	131	52,80 €
52275	123	48,00 €
52276	53	7,70 €
52277	53	8,70 €
52278	53	9,20 €
52279	53	6,70 €
52280	53	7,90 €
52281	53	6,70 €
52282	53	6,90 €
52283	53	7,90 €
52284	53	7,40 €
52290	203	72,00 €
52291	203	134,00 €
52292	203	150,80 €
52293	137	98,00 €
52294	154	71,70 €
52295	117	5,00 €
52296	141	75,80 €
52297	141	111,00 €
52298	141	146,90 €
52299	78	29,80 €
52300	78	32,00 €
52302	80	28,00 €
52303	80	28,00 €
52304	196	57,50 €
52305	134	149,00 €
52306	69	50,00 €
52307	69	118,00 €
52308	69	369,00 €
52309	69	733,00 €
52310	219	2,90 €
52311	124	15,00 €
52312	124	12,00 €
52313	124	12,00 €
52314	124	14,00 €
52315	123	22,00 €
52316	136	17,60 €
52317	136	18,30 €
52318	152	58,40 €
52319	154	8,20 €
52320	28	26,00 €
52321	117	10,40 €
52325	47	12,00 €
52327	117	12,00 €
52328	123	99,00 €
52329	190	32,00 €
52330	122	226,00 €
52331	92	183,50 €
52337	103	47,50 €
52338	104	32,00 €
52339	106	48,00 €

REF.	pag.	€
52340	106	48,00 €
52341	103	42,00 €
52342	103	47,90 €
52343	104	42,00 €
52344	105	148,00 €
52345	103	78,20 €
52346	103	78,20 €
52347	107	118,00 €
52348	107	168,00 €
52349	56	12,30 €
52350	56	13,90 €
52351	56	15,20 €
52352	56	18,60 €
52353	56	20,30 €
52354	56	21,80 €
52355	56	23,40 €
52356	56	33,10 €
52357	56	37,20 €
52358	56	41,30 €
52359	56	45,60 €
52360	62	550,00 €
52362	85	1,68 €
52363	85	1,68 €
52364	85	3,92 €
52365	85	3,42 €
52366	85	0,57 €
52367	85	0,57 €
52368	85	1,56 €
52369	85	1,62 €
52370	85	1,59 €
52371	85	0,36 €
52373	64	135,00 €
52375	78	36,00 €
52376	96	258,00 €
52378	96/159	8,00 €
52381	99	15,60 €
52382	212	24,00 €
52383	205	16,00 €
52384	73	32,00 €
52385	116	147,50 €
52386	115	19,00 €
52387	115	19,80 €
52388	115	22,50 €
52389	55	26,20 €
52390	115	28,40 €
52391	192	9,00 €
52392	192	7,00 €
52393	61	650,00 €
52394	228	8,15 €
52395	228	8,15 €
52396	228	8,25 €
52397	228	8,50 €
52398	228	8,60 €

REF.	pag.	€
52399	228	8,45 €
52400	228	8,90 €
52401	228	9,35 €
52402	228	9,45 €
52403	228	9,65 €
52404	228	9,90 €
52405	228	9,95 €
52406	228	10,70 €
52407	228	10,85 €
52408	228	11,35 €
52409	228	13,40 €
52410	85	0,36 €
52411	51	16,00 €
52412	51	5,00 €
52414	80	31,00 €
52415	80	31,00 €
52416	126	9,20 €
52417	126	19,90 €
52418	19	144,00 €
52419	65	58,00 €
52420	65	69,00 €
52421	65	98,00 €
52422	157	19,80 €
52424	38	54,80 €
52425	39	23,90 €
52426	39	43,50 €
52427	39	54,10 €
52428	190	43,10 €
52429	209	138,40 €
52430	217	7,90 €
52431	217	3,40 €
52432	142	28,00 €
52433	148	5,80 €
52434	123	189,00 €
52436	211	830,00 €
52438	212	42,80 €
52439	212	188,00 €
52440	217	3,90 €
52441	217	3,90 €
52442	217	3,70 €
52445	217	3,70 €
52447	218	7,50 €
52448	218	7,85 €
52449	218	7,95 €
52450	213	125,60 €
52451	36	30,50 €
52452	188	6,80 €
52453	188	17,00 €
52454	137	18,00 €
52455	123	16,00 €
52456	78	41,00 €
52458	83	47,00 €
52460	40	11,70 €

REF.	pag.	€
52461	40	18,70 €
52462	42	21,30 €
52463	42	19,90 €
52464	42	36,50 €
52465	205	55,90 €
52466	159	7,40 €
52467	159	8,50 €
52468	47	4,80 €
52472	46	3,60 €
52473	46	6,30 €
52474	116	52,00 €
52475	116	49,90 €
52476	116	49,80 €
52477	115	55,90 €
52478	115	49,00 €
52479	115	40,80 €
52480	116	43,80 €
52481	116	41,80 €
52482	116	43,80 €
52483	116	40,80 €
52484	116	52,80 €
52485	116	43,10 €
52486	116	48,00 €
52487	116	50,20 €
52488	133	29,90 €
52489	134	52,00 €
52490	99	4,70 €
52491	99	7,70 €
52493	224	3,50 €
52494	143	189,00 €
52495	149	19,00 €
52497	158	15,60 €
52498	191	48,30 €
52499	78	42,00 €
52500	48	14,80 €
52501	48	18,00 €
52502	115	22,40 €
52503	115	23,70 €
52504	115	19,10 €
52505	115	12,50 €
52506	115	13,60 €
52507	115	20,70 €
52508	55	32,30 €
52509	55	33,60 €
52510	115	26,20 €
52511	115	36,30 €
52512	115	37,40 €
52514	200	64,00 €
52515	155	9,10 €
52516	158	21,80 €
52517	158	9,20 €
52518	125	74,10 €
52519	31	30,70 €

REF.	pag.	€
52520	31	38,00 €
52521	31	109,00 €
52523	73	46,00 €
52524	45	43,60 €
52525	45	11,10 €
52526	45	22,80 €
52527	92	59,50 €
52528	94	44,00 €
52529	99	26,00 €
52530	227	10,80 €
52531	116	5,60 €
52533	116	7,60 €
52534	227	12,00 €
52535	227	9,40 €
52536	73	42,00 €
52538	29	56,00 €
52539	29	56,00 €
52540	97	159,70 €
52541	139	32,00 €
52542	70	110,00 €
52543	98	128,70 €
52544	105	78,00 €
52545	107	178,00 €
52546	105	28,90 €
52547	103	69,00 €
52548	77	65,00 €
52549	77	62,00 €
52550	22	74,50 €
52551	144	128,70 €
52552	234	208,00 €
52555	86	2,60 €
52556	86	2,60 €
52557	86	2,60 €
52558	86	2,60 €
52565	39	8,80 €
52566	80	39,00 €
52567	80	39,00 €
52568	80	43,00 €
52569	80	43,00 €
52570	218	1,99 €
52571	218	1,99 €
52572	218	1,99 €
52573	218	1,99 €
52574	94	58,00 €
52575	42	85,30 €
52582	74	4,95 €
52583	147	8,90 €
52584	74	11,20 €
52585	44	29,30 €
52586	44	36,00 €
52587	44	27,00 €
52588	44	27,50 €
52589	117	9,60 €

REF.	pag.	€
52591	156	12,00 €
52592	156	19,00 €
52593	156	31,30 €
52595	42	49,60 €
52596	42	95,00 €
52597	42	114,50 €
52601	189	303,50 €
52603	23	72,00 €
52604	23	66,00 €
52605	23	72,00 €
52606	23	76,00 €
52607	126	37,50 €
52608	126	42,50 €
52609	42	27,70 €
52613	154	15,20 €
52615	124	84,50 €
52616	128	37,50 €
52617	127	4,90 €
52618	223	48,00 €
52619	54	23,10 €
52620	158	6,90 €
52621	154	7,10 €
52622	130	65,20 €
52624	138	15,00 €
52625	55	7,00 €
52626	140	31,20 €
52627	140	67,80 €
52628	191	26,50 €
52629	130	84,50 €
52633	236	0,80 €
52634	65	3,70 €
52635	65	3,60 €
52636	122	126,80 €
52637	145	40,20 €
52638	56	5,00 €
52639	152	140,90 €
52640	152	54,60 €
52641	152	58,80 €
52642	140	20,60 €
52643	207	490,00 €
52644	236	6,60 €
52645	236	0,38 €
52646	236	0,32 €
52648	98	6,00 €
52649	232	5,00 €
52650	232	5,00 €
52651	230	3,89 €
52652	230	2,80 €
52653	230	3,00 €
52654	232	6,00 €
52655	233	34,30 €
52656	233	25,60 €
52657	233	37,90 €

REF.	pag.	€
52658	233	37,90 €
52659	233	37,90 €
52660	234	68,00 €
52661	234	225,00 €
52662	233	30,70 €
52663	233	27,10 €
52664	234	198,00 €
52665	229	0,26 €
52666	229	0,26 €
52667	230	0,64 €
52668	230	1,21 €
52669	230	1,80 €
52670	230	2,50 €
52671	230	2,97 €
52672	230	3,55 €
52673	235	18,00 €
52674	116	110,60 €
52675	96	69,20 €
52676	96	76,70 €
52677	126	12,40 €
52678	126	13,00 €
52681	218	7,85 €
52682	218	8,15 €
52683	218	8,25 €
52684	38	26,60 €
52685	133	74,00 €
52687	150	298,00 €
52689	93	144,50 €
52690	137	33,30 €
52691	136	48,80 €
52692	200	105,40 €
52693	154	36,70 €
52694	104	34,60 €
52696	156	6,80 €
52697	156	9,70 €
52698	140	24,00 €
52699	140	15,20 €
52700	136	18,00 €
52701	217	30,90 €
52703	242	19,00 €
52704	59	790,00 €
52705	59	850,00 €
52711	243	22,00 €
52712	18	79,00 €
52713	15	68,00 €
52714	27	12,70 €
52715	27	7,60 €
52716	27	13,50 €
52717	27	8,20 €
52718	92	34,00 €
52719	245	0,19 €
52720	13	24,00 €
52721	14	48,00 €

REF.	pag.	€
52722	13	88,00 €
52723	14	42,00 €
52724	94	292,00 €
52725	94	280,30 €
52727	141	27,00 €
52728	141	57,80 €
52729	141	138,70 €
52730	141	309,90 €
52731	141	34,00 €
52732	141	61,00 €
52733	141	115,00 €
52734	154	72,20 €
52735	100	4,50 €
52736	100	4,50 €
52737	100	4,50 €
52738	219	4,65 €
52739	219	4,65 €
52740	76	495,00 €
52741	83	218,00 €
52742	225	62,00 €
52743	225	35,00 €
52744	226	38,00 €
52748	48	34,50 €
52749	118	49,00 €
52753	22	86,00 €
52754	133	62,00 €
52755	101	98,00 €
52756	159	6,00 €
52757	155	18,10 €
52758	96	69,20 €
52759	56	14,10 €
52760	155	4,10 €
52761	51	7,00 €
52762	51	7,60 €
52764	59	790,00 €
52765	117	22,00 €
52767	89	328,00 €
52768	222	18,50 €
52769	222	18,50 €
52770	222	18,50 €
52771	222	18,50 €
52772	222	18,50 €
52773	222	18,50 €
52774	222	18,50 €
52775	222	18,50 €
52776	222	18,50 €
52777	222	18,50 €
52778	222	18,50 €
52779	222	18,50 €
52780	222	18,50 €
52781	222	18,50 €
52782	222	18,50 €
52783	222	18,50 €

REF.	pag.	€
52786	50	11,30 €
52787	99	6,20 €
52788	113	42,90 €
52789	190	14,10 €
52790	88	168,00 €
52791	54	16,00 €
52793	147	70,50 €
52794	147	29,30 €
52795	222	4,90 €
52796	149	85,20 €
52797	190	238,00 €
52798	99	12,80 €
52800	104	12,00 €
52801	131	21,90 €
52802	136	37,80 €
52804	187	244,00 €
52805	187	290,00 €
52806	187	465,00 €
52807	187	1.199,00 €
52808	222	7,60 €
52809	124	9,20 €
52810	105	9,20 €
52811	105	9,20 €
52812	54	49,90 €
52813	131	88,00 €
52814	90	448,00 €
52815	134	144,00 €
52816	134	22,80 €
52817	134	21,40 €
52818	232	168,00 €
52819	185	23,80 €
52820	131	32,40 €
52821	128	21,20 €
52822	131	29,70 €
52823	135	153,90 €
52824	211	535,80 €
52825	59	850,00 €
52826	64	348,00 €
52827	78	36,90 €
52828	78	36,90 €
52829	235	18,00 €
52830	40	20,30 €
52831	40	13,80 €
52832	137	58,30 €
52833	136	39,30 €
52834	143	194,40 €
52835	143	212,20 €
52836	76	890,00 €
52838	83	53,50 €
52839	83	55,90 €
52840	6	148,00 €
52842	232	6,70 €
52843	79	32,40 €

REF.	pag.	€
52844	151	79,00 €
52845	199	120,00 €
52846	53	37,80 €
52847	53	37,80 €
52848	83	75,60 €
52849	145	6,00 €
52850	130	6,20 €
52851	114	8,10 €
52852	56	3,70 €
52855	231	372,60 €
52856	232	62,00 €
52857	259	5,80 €
52858	129	248,00 €
52859	85	0,45 €
52860	85	0,36 €
52861	85	0,36 €
52862	85	1,80 €
52863	85	1,80 €
52864	85	1,80 €
52865	85	0,41 €
52866	85	0,41 €
52867	85	0,81 €
52868	85	0,40 €
52869	69	47,90 €
52870	69	102,20 €
52871	69	230,00 €
52873	147	8,75 €
52874	152	59,40 €
52875	152	64,80 €
52876	112	153,90 €
52877	50	13,00 €
52878	50	11,20 €
52879	50	11,20 €
52880	46/234	24,90 €
52881	46/234	11,90 €
52882	156	9,80 €
52883	74	38,00 €
52884	204	50,60 €
52885	56	16,20 €
52886	251	21,60 €
52887	251	24,30 €
52888	254	24,30 €
52889	252	21,60 €
52890	253	21,60 €
52891	252	24,30 €
52892	253	21,60 €
52893	253	24,30 €
52894	253	21,60 €
52895	254	21,60 €
52896	251	24,30 €
52897	253	35,10 €
52898	254	29,70 €
52899	251	29,70 €

REF.	pag.	€
52900	252	29,70 €
52901	252	32,40 €
52904	147	43,80 €
52905	50	27,90 €
52906	123	76,20 €
52908	27	14,30 €
52909	27	10,00 €
52910	78	37,60 €
52912	37	77,50 €
52913	145	272,60 €
52914	109	178,50 €
52915	109	161,00 €
52916	109	153,70 €
52917	109	98,50 €
52918	109	118,10 €
52919	109	146,80 €
52920	109	114,10 €
52921	109	83,40 €
52922	109	117,10 €
52923	109	36,30 €
52924	109	41,90 €
52925	109	112,50 €
52926	109	143,50 €
52927	109	49,20 €
52928	109	114,00 €
52929	109	122,50 €
52930	110	97,80 €
52931	110	33,10 €
52932	110	33,50 €
52933	110	133,60 €
52934	110	76,30 €
52935	110	81,00 €
52936	110	137,70 €
52937	110	189,00 €
52938	110	140,40 €
52939	110	24,30 €
52940	110	170,10 €
52941	110	54,00 €
52942	110	70,20 €
52943	110	64,80 €
52944	110	86,40 €
52945	110	178,20 €
52946	78	37,60 €
52947	145	16,20 €
52948	43	25,00 €
52949	43	25,00 €
52950	43	14,50 €
52951	43	14,50 €
52952	212	64,80 €
52953	95	26,00 €
52954	203	55,70 €
52955	56	15,10 €
52956	56	17,95 €

REF.	pag.	€
52957	56	21,50 €
52958	56	28,50 €
52959	56	38,65 €
52960	56	47,05 €
52961	137	75,70 €
52962	135	88,00 €
52963	211	64,40 €
52964	52	9,00 €
52965	52	9,00 €
52966	52	9,00 €
52967	52	9,00 €
52969	104	15,25 €
52970	35	33,00 €
52971	35	47,00 €
52972	24	89,00 €
52973	36	46,00 €
52974	36	15,30 €
52975	36	62,00 €
52976	36	19,70 €
52977	113	98,00 €
52978	8	78,00 €
52979	7	79,00 €
52980	207	368,00 €
52981	88	182,00 €
52982	52	42,30 €
52983	89	148,00 €
52984	88	99,00 €
52985	198	354,00 €
52987	74	33,70 €
52991	192	6,45 €
52992	192	11,60 €
52995	259	195,00 €
52998	117	55,20 €
52999	198	144,00 €
53001	150	240,00 €
53007	85	0,40 €
53008	125	14,45 €
53009	129	36,10 €
53010	48	14,90 €
53011	9	69,00 €
53017	33	52,00 €
53018	35	128,00 €
53019	33	68,00 €
53020	34	235,00 €
53021	33	48,00 €
53022	33	42,00 €
53023	34	59,00 €
53025	148	2,90 €
53026	148	4,90 €
53027	148	6,90 €
53028	205	3,30 €
53029	205	3,80 €
53030	205	8,90 €

REF.	pag.	€
53031	69	45,50 €
53032	69	98,70 €
53033	225	10,50 €
53034	58	570,00 €
53035	58	859,00 €
53036	58	859,00 €
53037	236	0,30 €
53038	236	0,30 €
53039	236	0,35 €
53040	236	0,30 €
53041	132	38,10 €
53042	147	10,50 €
53043	105	38,00 €
53044	107	98,00 €
53045	81	38,60 €
53046	81	34,00 €
53047	82	265,50 €
53048	82	85,00 €
53049	81	85,00 €
53050	82	85,00 €
53051	82	169,50 €
53052	81	169,50 €
53053	138	8,50 €
53054	155	3,30 €
53055	155	29,00 €
53056	143	99,00 €
53057	149	154,00 €
53058	143	154,00 €
53059	144	42,00 €
53060	103	27,40 €
53061	20	44,00 €
53062	141	132,00 €
53063	100	29,00 €
53064	100	29,00 €
53065	100	29,00 €
53066	100	48,00 €
53067	100	48,00 €
53068	100	48,00 €
53069	128	112,00 €
53070	55	13,50 €
53071	55	17,60 €
53072	55	25,30 €
53073	55	38,30 €
53074	10	74,50 €
53075	11	60,00 €
53076	24	78,00 €
53077	106	56,00 €
53078	188	14,10 €
53079	118	69,50 €
53080	118	67,30 €
53081	146	98,00 €
53082	146	116,00 €
53083	41	44,00 €

REF.	pag.	€
53084	27	19,00 €
53085	75	24,00 €
53086	155	9,00 €
53087	222	11,50 €
53088	222	11,50 €
53089	222	11,50 €
53090	222	11,50 €
53091	222	10,70 €
53092	222	10,70 €
53093	222	10,70 €
53094	222	10,70 €
53095	40	14,00 €
53096	155	38,00 €
53098	43	13,00 €
53099	43	15,00 €
53100	43	18,00 €
53101	12	33,00 €
53102	12	34,00 €
53103	20	36,00 €
53104	21	36,00 €
53105	21	36,00 €
53106	17	107,70 €
53107	13	27,00 €
53108	13	89,00 €
53109	188	266,00 €
53110	114	22,00 €
53111	205	12,00 €
53112	194	174,00 €
53113	58	859,00 €
53115	101	134,00 €
53116	58	99,50 €
53117	59/60/61	93,50 €
53118	153	207,00 €
53119	157	32,00 €
53120	41	3,90 €
53121	41	4,80 €
53122	41	6,00 €
53123	118	44,50 €
53124	118	205,00 €
53125	118	335,00 €
53126	118	153,00 €
53127	27	7,50 €
53129	144	56,00 €
53130	77	48,00 €
53131	77	48,00 €
53134	118	95,00 €
53135	90	468,00 €
53136	96	151,55 €
53137	93	38,10 €
53140	95	84,95 €
53141	93	60,30 €
53142	89	285,85 €
53144	192	14,00 €

REF.	pag.	€
53145	205	29,35 €
53146	141	22,00 €
53147	91	27,20 €
53150	209	16,50 €
53151	83	12,50 €
53152	30	343,55 €
53153	30	372,00 €
53154	30	428,00 €
53156	26	21,00 €
53157	232	62,00 €
53158	25	151,50 €
53159	26	262,00 €
53160	25	247,50 €
53161	196	188,00 €
53162	205	47,35 €
53163	79	33,20 €
53164	31	13,50 €
53165	31	16,00 €
53166	209	8,55 €
53167	209	10,50 €
53168	209	16,25 €
53169	221	11,00 €
53170	221	11,00 €
53171	221	11,00 €
53172	221	11,00 €
53173	221	15,00 €
53174	221	15,00 €
53175	221	15,00 €
53176	221	15,00 €
53177	221	11,50 €
53178	221	11,50 €
53179	221	11,50 €
53180	221	11,50 €
53181	221	16,00 €
53182	221	16,00 €
53183	221	16,00 €
53184	221	16,00 €
53185	221	13,00 €
53186	221	17,00 €
53187	192	23,45 €
53188	192	3,90 €
53189	209	89,50 €
53190	209	74,80 €
53191	120	10,00 €
53192	120	43,00 €
53193	66	366,00 €
53195	60	498,00 €
53196	158	16,35 €
53197	105	37,00 €
53198	192	6,35 €
53199	75	40,05 €
53200	197	126,80 €
53201	14	31,65 €

REF.	pag.	€
53202	100	15,65 €
53203	85	0,36 €
53204	100	56,30 €
53205	99	14,65 €
53206	125	27,25 €
53207	134	86,95 €
53208	134	108,05 €
53209	204	5,05 €
53210	55	30,90 €
53211	70	54,00 €
53212	16	148,00 €
53213	101	134,00 €
53214	187	225,00 €
53215	192	14,80 €
53216	73	47,25 €
53217	72	37,60 €
53218	195	17,60 €
53219	11	59,00 €
53220	207	282,35 €
53221	225	3,20 €
53222	67	47,60 €
53223	188	366,30 €
53224	112	153,45 €
53225	47	2,80 €
53226	120	10,75 €
53227	75	23,20 €
53229	244	27,90 €
53230	114	15,45 €
53231	122	29,90 €
53232	114	39,05 €
53233	225	16,05 €
53234	225	6,90 €
53235	127	9,90 €
53236	127	11,55 €
53237	127	12,50 €
53238	127	14,85 €
53240	157	37,40 €
53241	227	5,95 €
53242	220	1,50 €
53243	220	1,50 €
53244	220	1,50 €
53245	220	1,50 €
53246	201	884,40 €
53248	76	115,25 €
53249	157	160,95 €
53250	129	89,15 €
53251	156	80,85 €
53252	68	42,50 €
53253	68	119,40 €
53258	68	75,40 €
53259	161	98,00 €
53260	161	217,00 €
53261	161	196,00 €

REF.	pag.	€
53262	162	218,00 €
53263	162	56,50 €
53264	162	131,50 €
53265	163	179,50 €
53266	163	197,00 €
53267	163	248,00 €
53268	164	108,00 €
53269	164	46,00 €
53270	164	62,00 €
53271	165	207,00 €
53272	165	163,00 €
53273	166	68,00 €
53274	168	40,00 €
53275	171	35,50 €
53276	167	146,00 €
53277	167	30,50 €
53278	166	132,00 €
53279	168	89,00 €
53280	166	97,50 €
53281	167	53,50 €
53282	168	48,00 €
53283	169	92,00 €
53284	169	285,00 €
53285	170	48,50 €
53286	170	95,00 €
53287	170	221,50 €
53288	171	72,00 €
53289	172	50,00 €
53290	172	49,00 €
53291	173	68,00 €
53292	173	119,00 €
53293	173	133,50 €
53294	174	111,00 €
53295	175	77,00 €
53296	175	58,50 €
53297	175	44,50 €
53298	176	80,50 €
53299	176	258,50 €
53300	176	40,00 €
53301	177	51,00 €
53302	177	46,00 €
53303	177	130,00 €
53304	178	240,00 €
53305	178	130,50 €
53306	179	54,50 €
53307	179	38,50 €
53308	180	52,50 €
53309	180	254,00 €
53310	180	425,50 €
53311	181	97,00 €
53312	181	132,00 €
53313	181	139,00 €
53314	182	90,00 €

REF.	pag.	€
53315	182	254,00 €
53316	179	27,00 €
53317	185	28,00 €
53318	183	23,00 €
53319	182	31,00 €
53320	183	10,50 €
53321	185	9,50 €
53322	183	9,00 €
53323	184	9,00 €
53324	174	12,00 €
53325	185	5,50 €
53326	169	13,50 €
53327	169	13,50 €
53328	135	91,95 €
53329	151	81,55 €
53330	130	27,60 €
53331	41	25,80 €
53332	41	27,95 €
53339	41	7,45 €
53340	244	67,35 €
53343	89	251,70 €
53344	89	290,75 €
53345	259	0,50 €
53346	45	16,00 €
53347	152	84,50 €
53348	239	8,10 €
53349	239	7,90 €
53350	239	9,85 €
53351	240	9,60 €
53352	240	9,60 €
53353	246	15,15 €
53354	241	9,85 €
53355	249	9,30 €
53356	249	9,50 €
53357	249	3,60 €
53358	249	8,75 €
53359	248	12,75 €
53360	242	11,75 €
53361	242	15,90 €
53362	241	9,05 €
53363	240	19,85 €
53364	240	10,00 €
53365	242	11,10 €
53366	241	8,85 €
53367	249	5,95 €
53368	250	5,50 €
53369	241	10,40 €
53370	239	19,40 €
53371	240	21,30 €
53372	239	10,95 €
53373	246	10,95 €
53374	248	7,10 €
53376	248	7,45 €

REF.	pag.	€
53377	244	16,00 €
53378	246	11,10 €
53379	243	12,10 €
53380	250	8,95 €
53381	246	11,75 €
53382	246	7,15 €
53383	246	7,15 €
53384	139	130,35 €
53385	51	14,50 €
53386	201	580,00 €
53387	203	215,15 €
53388	142	80,10 €
53389	52	22,30 €
53390	54	25,95 €
53391	142	58,40 €
53392	149	44,20 €
53393	142	98,20 €
53394	153	519,20 €
53395	158	12,35 €
53396	54	13,70 €
53397	18	157,20 €
53398	18	157,20 €
53399	219	2,80 €
53400	219	3,60 €
53401	219	4,15 €
53402	219	7,60 €
53403	219	5,10 €
53404	219	5,30 €
53405	219	4,00 €
53406	219	6,80 €
53407	219	10,00 €
53408	219	15,25 €
53409	219	7,60 €
53410	149	74,55 €
53411	50	3,25 €
53412	50	2,65 €
53413	120	3,75 €
53414	113	49,25 €
53415	113	152,35 €
53416	98	11,60 €
53417	98	19,20 €
53418	98	10,15 €
53419	235	7,90 €
53420	37	56,65 €
53421	195	224,55 €
53422	195	305,20 €
53423	201	155,40 €
53424	232	62,00 €
53425	232	62,00 €
53426	133	25,15 €
53427	74	3,20 €
53428	80	12,80 €
53429	80	12,80 €

REF.	pag.	€
53430	110	203,80 €
53431	72	33,70 €
53432	72	37,70 €
53433	72	45,10 €
53434	248	12,95 €
53439	72	24,65 €
53443	224	6,15 €
53444	25	168,60 €
53445	51	11,25 €
53449	98	15,95 €
53450	98	20,75 €
53451	151	45,05 €
53453	204	4,30 €
53454	77	45,95 €
53455	77	49,40 €
53456	151	81,55 €
53457	150	21,05 €
53458	151	3,45 €
53459	151	60,40 €
53460	88	198,00 €
53461	58	570,00 €
53462	58	570,00 €
53546	63	1.525,20 €
70001	256	32,00 €
70002	256	32,00 €
70003	256	32,00 €
70004	256	38,00 €
70005	256	38,00 €
70006	256	38,00 €
70007	256	32,00 €
70008	256	32,00 €
70009	256	32,00 €
70010	256	38,00 €
70011	256	38,00 €
70012	256	38,00 €
90003	98	35,20 €
90004	98	25,80 €
JBMWB13	228	8,05 €
JBMWB14	228	8,30 €
JBMWB15	228	8,90 €
JBMWB16	228	9,35 €
JBMWB17	228	10,55 €
JBMWB18	228	10,70 €
JBMWB18S	228	6,55 €
JBMWB19	228	11,25 €
JBMWB19S	228	7,05 €
JBMWB20	228	11,45 €
JBMWB20S	228	7,20 €
JBMWB21	228	12,50 €
JBMWB21S	228	7,70 €
JBMWB22	228	12,70 €
JBMWB22S	228	7,85 €
JBMWB24	228	13,45 €

REF.	pag.	€
JBMWB24S	228	8,50 €
JBMWB26S	228	10,30 €
JBMWB28S	228	11,40 €
JBMWBEXP	228	15,00 €
METEXP	227	34,90 €
SERIE124	236	398,00 €
SERIE75	98	183,00 €

*Prețurile de vânzare cu amănuntul. Taxele nu sunt incluse.

* Prețurile sunt valabile până la 31 Decembrie din 2018, până la o nouă ediție de catalog, până la o nouă revizie de tarife sau până la terminarea existențelor.

CONDIȚII GENERALE

- Prețurile sunt valabile până la 31 Decembrie din 2018, până la o nouă ediție de catalog, până la o nouă revizie de tarife sau până la terminarea existențelor.
- Pentru primele achiziții, plățile vor fi furnizate în numerar sau prin transfer bancar în avans.
- Consultați comanda minimă pentru ca transportul să fie plătit.
- **Política de devoluciones:**
 - JBM CAMPLLONG, S.L. va accepta returnarea produselor doar în 48 de ore posteroare datei de livrare și transportul returnării va fi suportat de client.
 - Notificare prealabilă și aprobarea Departamentului de calitate: calidad@jbmcamp.com. Odată ce returul a fost aprobat, va fi necesar să introduceți numărul RMA indicat de JBM în toate retururile.
 - Notă de credit nu va fi făcută până când produsele nu vor fi verificate fizic în depozitul JBM.
 - Retururile vor fi acceptate numai în cazul când dauna a fost produsă de compania de transport, și când acestea sunt reflectate în buletinul de transport al transportatorului. Indicați întotdeauna deteriorarea ambalajului pe nota de livrare a transportatorului.
- Toate materialele furnizate de JBM CAMPLLONG, S.L. este întotdeauna considerată sub starea Rezervarea de titlu, conform Directivei 2011/7/UE, Parlamentului European și a Consiliului din 16 februarie 2011, de stabilire a privind combaterea întârzierii efectuării plăților în tranzacțiile comerciale; încorporate în legislația spaniolă, de Royal Decretul-lege, din 22 februarie, de masuri de susținere a antreprenor și stimularea creșterii și crearea de locuri de munca.
- JBM CAMPLLONG, S.L. își rezervă dreptul de a modifica caracteristicile și prețurile produselor și/ sau promoțiilor, fără preaviz.
- Caracteristicile și prețurile promovii sunt valabile în timp ce alimentează ultima.
- Este strict interzisă divulgarea prețurilor de vânzare sau de ofertă, în forma imprimată sau digitală, publicată în acest catalog, cu excepția cazului în care este autorizată în scris de către JBM CAMPLLONG, S.L.
- JBM CAMPLLONG, S.L. nu permite modificarea prețurilor de vânzare din acest catalog și posteroare oferte, sub nici un motiv.

* Prețurile afișate nu includ taxe.



JBM CAMPLLONG, S.L

C/ Rejas, 2 - P5, Oficina 17
28821 Coslada - Madrid - SPAIN
T. +34 972 40 57 21 / T. +34 972 24 55 33
F. +34 972 24 54 37
jbmcamp.com

ADRESA DEPOZITELOR

JBM CAMPLLONG, S.L
CIM La Selva
Ctra. de l'Aeroport Km. 1,6 Parc. 2.2
17185 Vilobi d'Onyar - Girona - SPAIN



WWW.JBMCAMP.COM



JBM

JBM®

CONTACT

ES: +34 972 40 57 21

+34 972 24 55 33

EN: +34 609 00 84 37

PT: +34 972 40 69 07

IT: +34 972 24 29 07

FR: +34 972 40 60 12

RO: +34 972 46 74 96

Fax. +34972 24 54 37

jbm@jbmcamp.com



JBM CAMPLLONG SL
C/ REJAS, 2 - P5, OFICINA 17
28821 COSLADA
MADRID - SPAIN

DEPOZITELOR:
POL. IND CIM LA SELVA
CTRA. DE L'AEROPORT
KM. 1,6 - PARC. 2.2
17185 VILOBI D'ONYAR
GIRONA - SPAIN

DISTRIBUITOR